

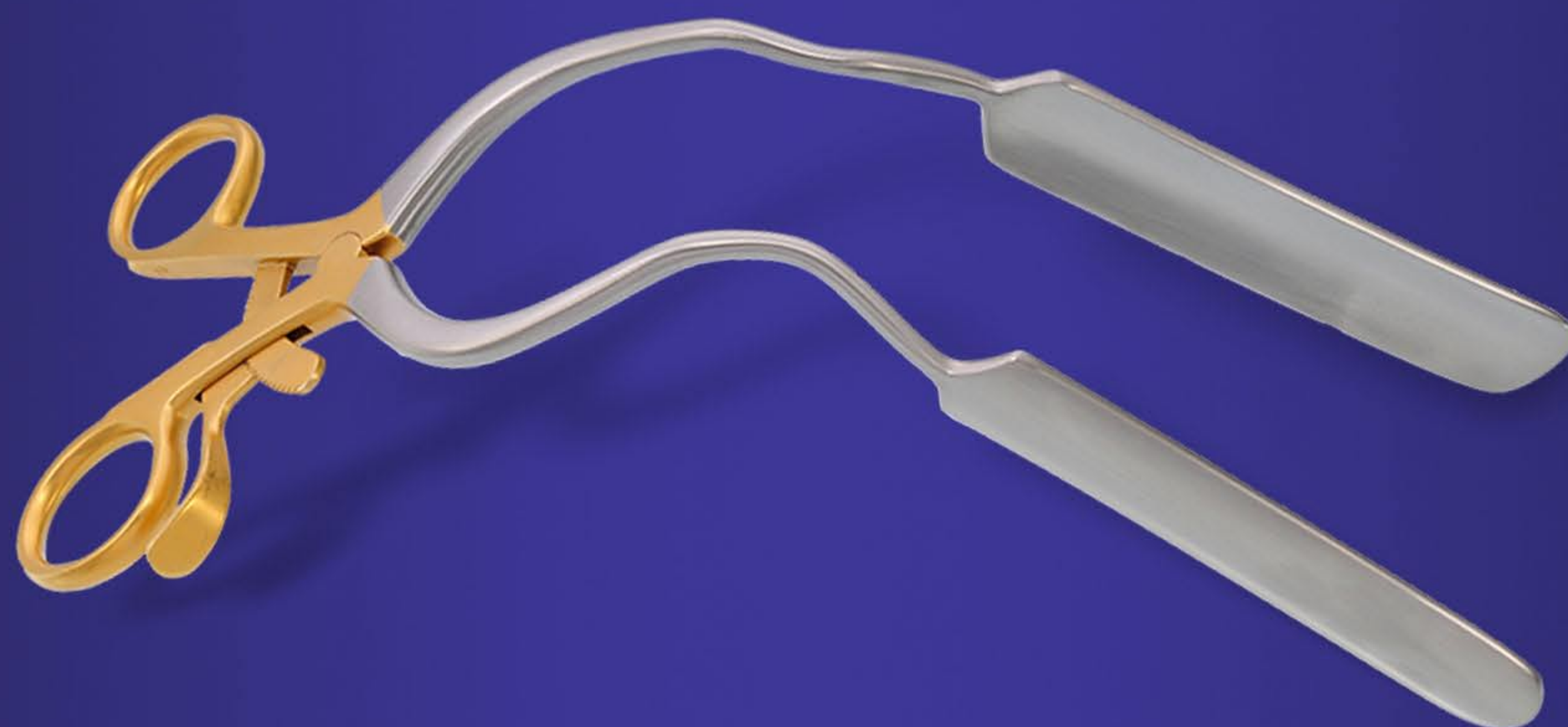

ASSURE  
*Surgical*



OUR 2014 SURGICAL CATALOGUE



**Percussion Hammers & Aesthesiometers**



**01-101**  
TROEMNER  
Size: 245 mm



**01-102**  
DEJERINE  
Size: 200 mm



**01-103**  
DEJERINE  
With Needle  
Size: 210 mm



**01-104**  
TAYLOR  
Size: 195 mm



**01-105**  
BERLINER  
Size: 200 mm

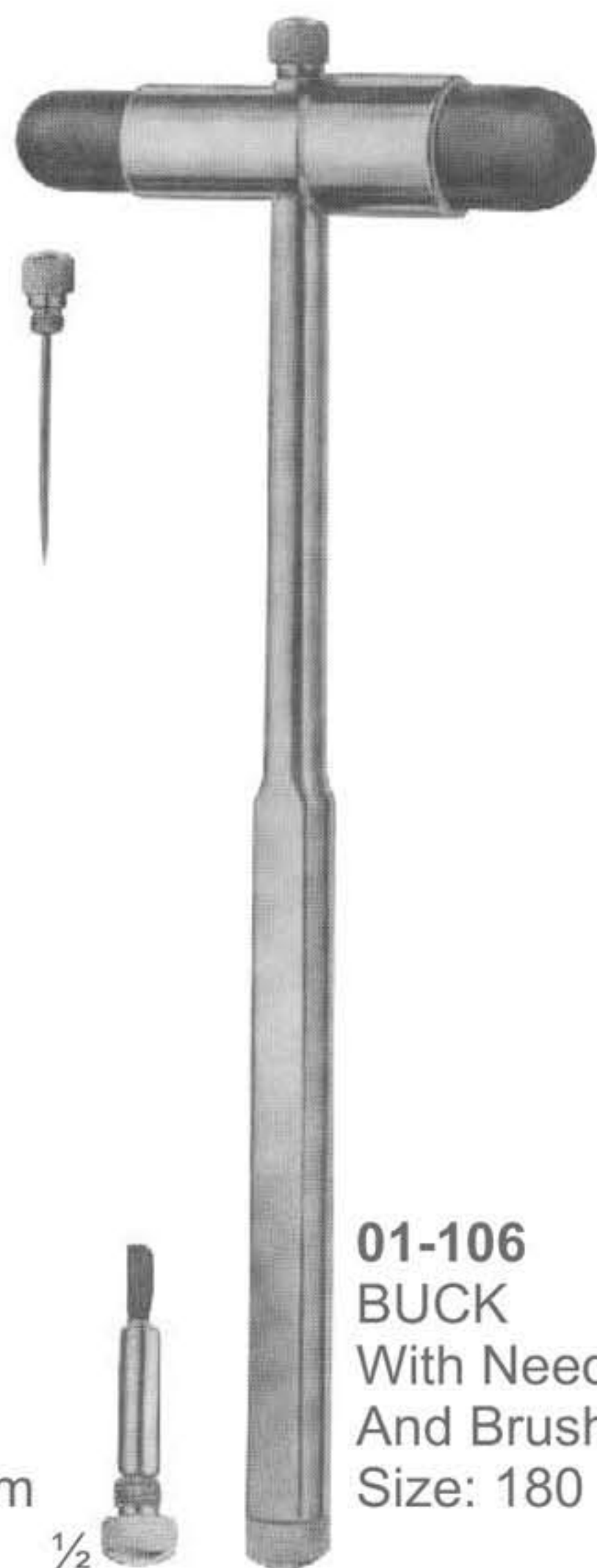

**01-106**  
BUCK  
With Needle  
And Brush  
Size: 180 mm

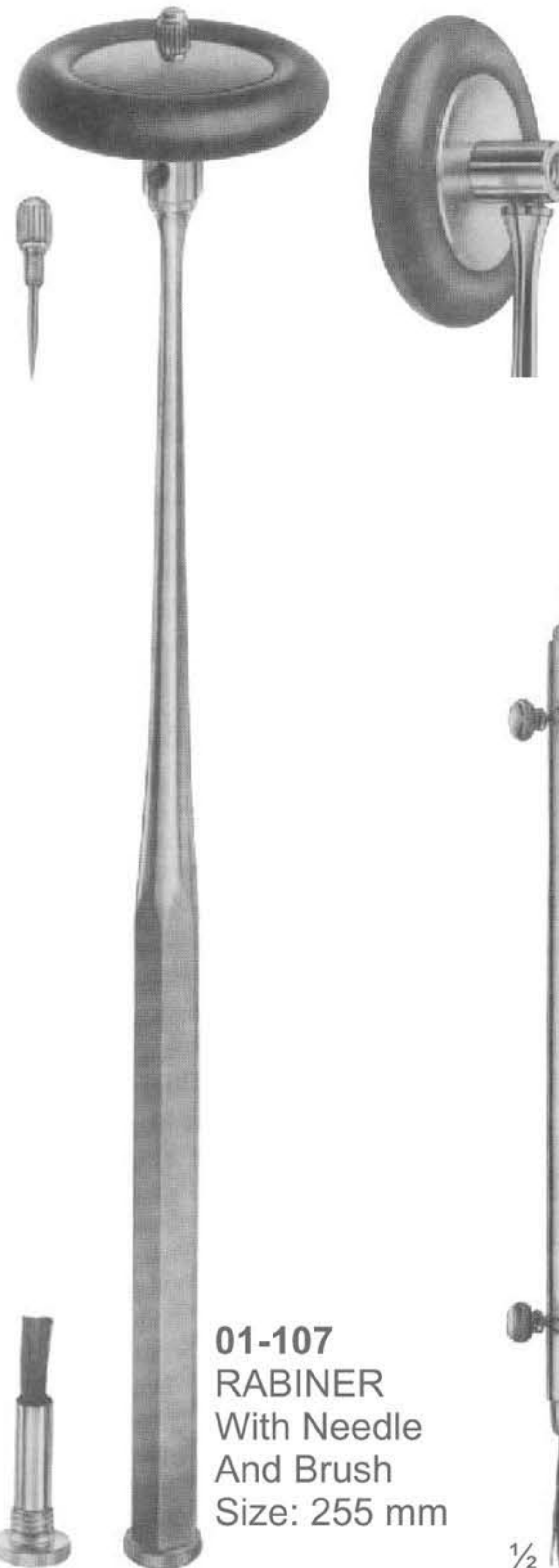

**01-107**  
RABINER  
With Needle  
And Brush  
Size: 255 mm



**01-108**  
ALY  
Size: 190 mm



**01-109**  
WARTENBERG  
Pinwheel For  
Neurological  
Examination  
Size: 185 mm



Stethoscopes



**01-110**  
PINARD (Aluminum)  
Size: 155 mm

1/2



**01-111**  
aus Holz (Wooden)  
Size: 145 mm

1/2



**01-112**  
BOWLES  
Stethoscope  
With Diaphragm

1/4



**01-113**  
ANESTOPHON

1/3



**01-114**  
FORD-BOWLES  
Duel Chest Piece  
With Two Outlets

1/4



**01-115**  
BOWLES

1/4



## Head Mirrors & Head Bands



**01-116**  
ZIEGLER  $\varnothing$  mm  
Head mirror only  
with rubber coating



**01-117**  
ZIEGLER  $\varnothing$  mm  
Head mirror only  
with metal coating



**01-118**  
ZIEGLER  
Head band of plastic black



**01-120**  
MURPHY  
Head band of celluloid, white

**01-119**  
ZIEGLER  
Head band of plastic white

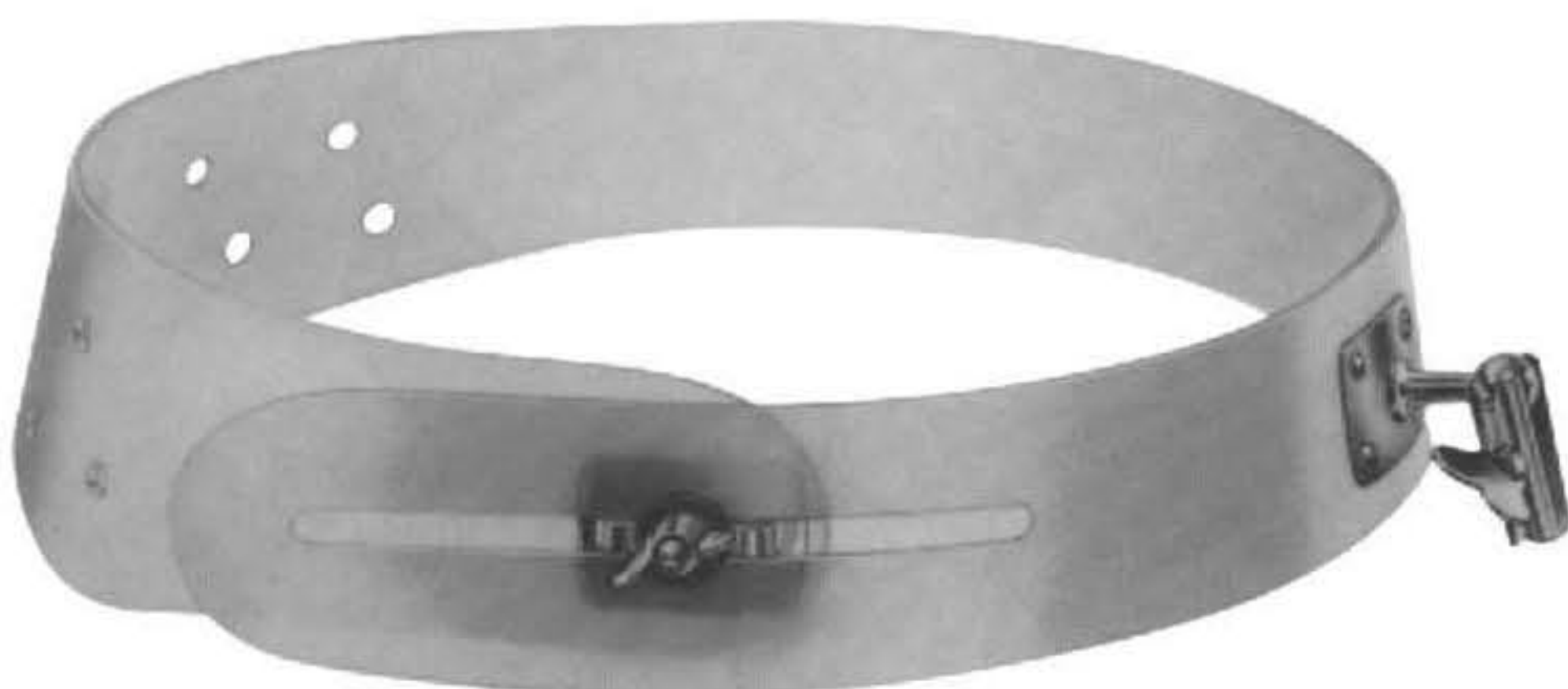

**01-121**  
Head band of plastic,  
white, soft pattern



**01-122**  
Head mirror with black  
plastic head band.



## Head Light

**01-123**

CLAR

Head light, 6 volt, with adjustable joint, white celluloid head band, cord with plugs for transformer

**01-124**

White celluloid head band, only, for

**01-125**

Spare mirror only, for



**01-127**

CLAR

Head light, 6 volt, with adjustable joint, white celluloid head band, with foam rubber pad and cord with plugs for transformer

**01-128**

White celluloid head band, only, for head light

**01-129**

mirror only, for head light

spare foam rubber pad, for head band

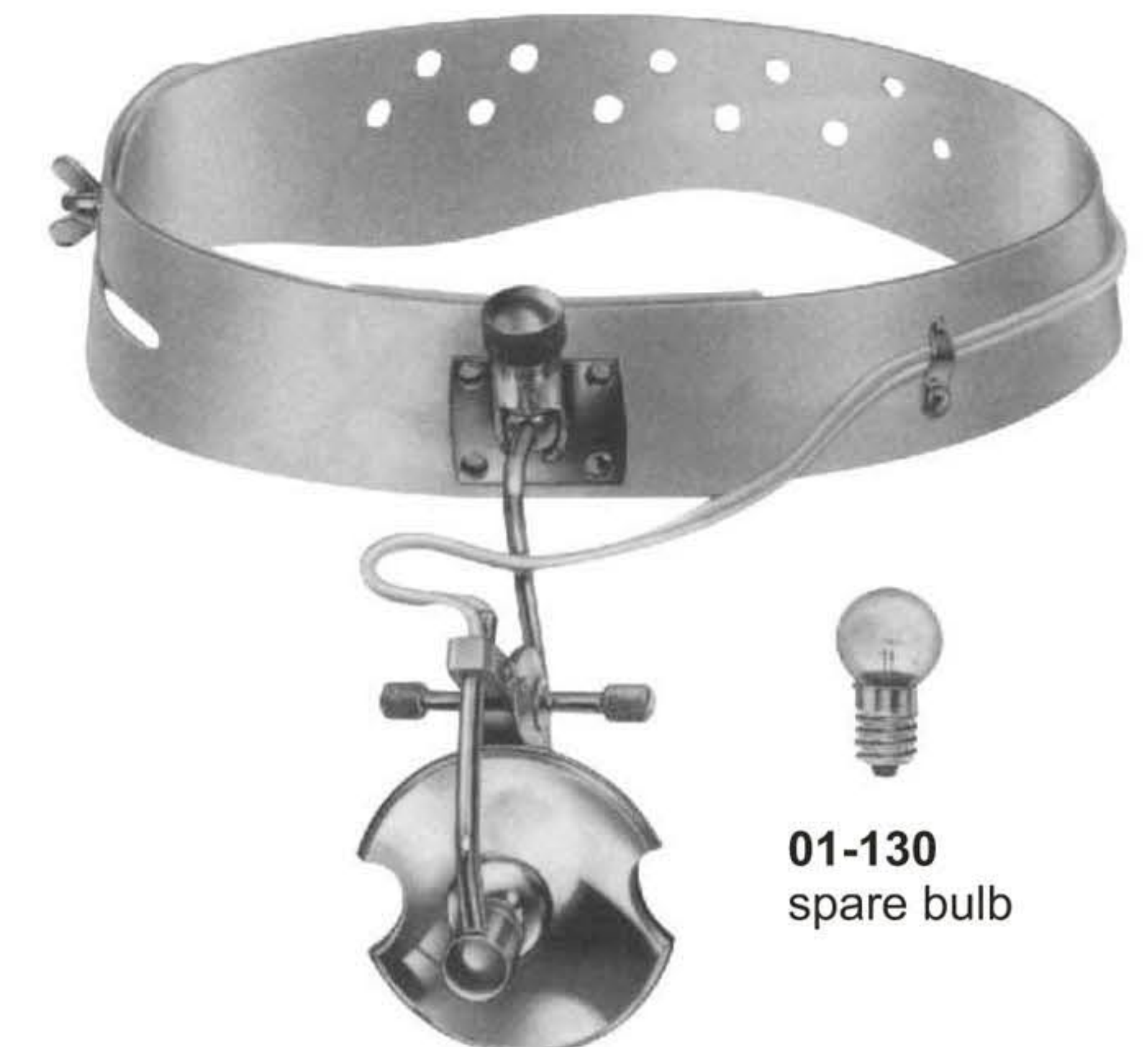

**01-131**

CLAR

Head light, 6 volt, with adjustable joint, white plastic head band, cord with plugs for transformer

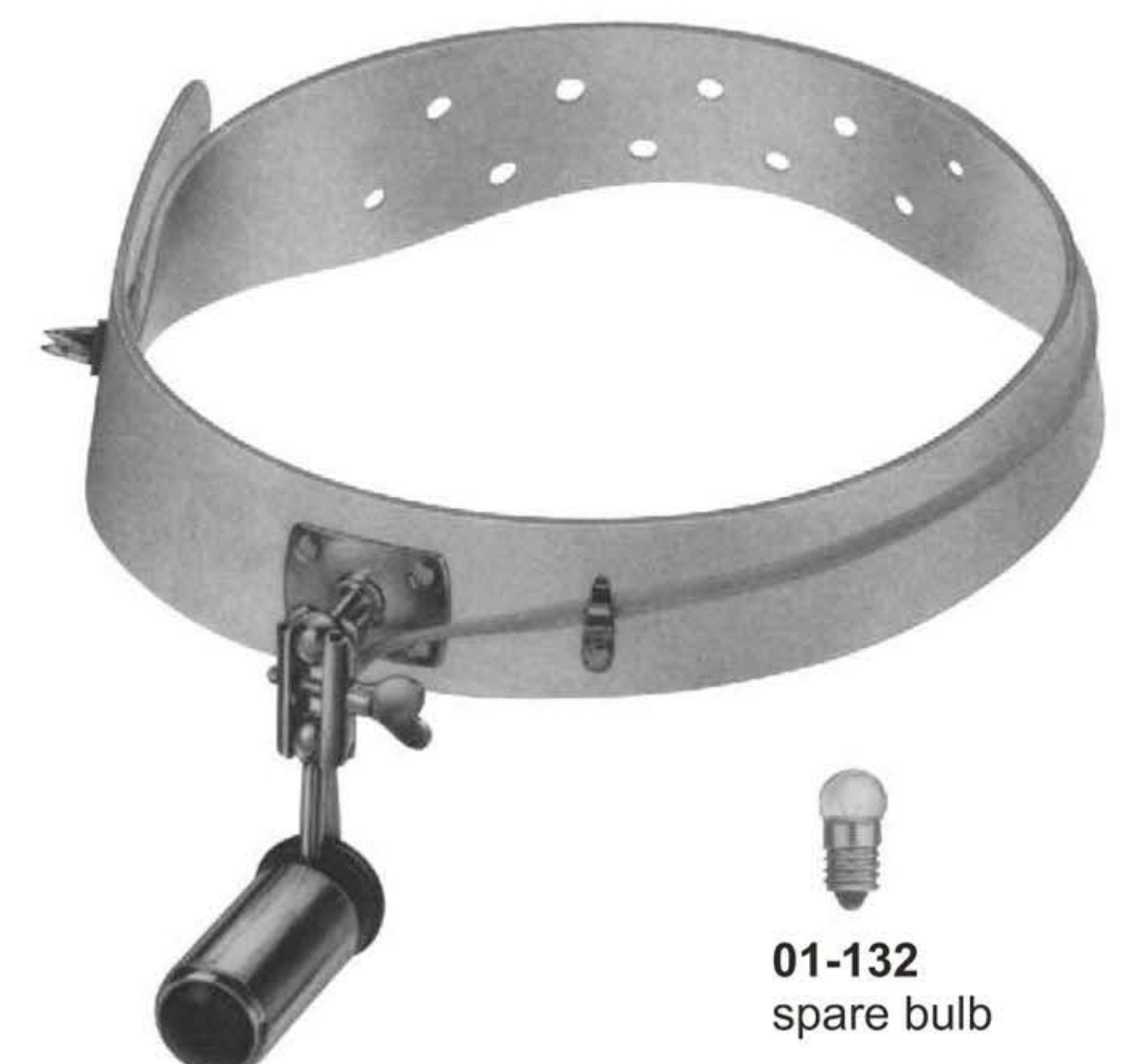



# Tongue Depressors

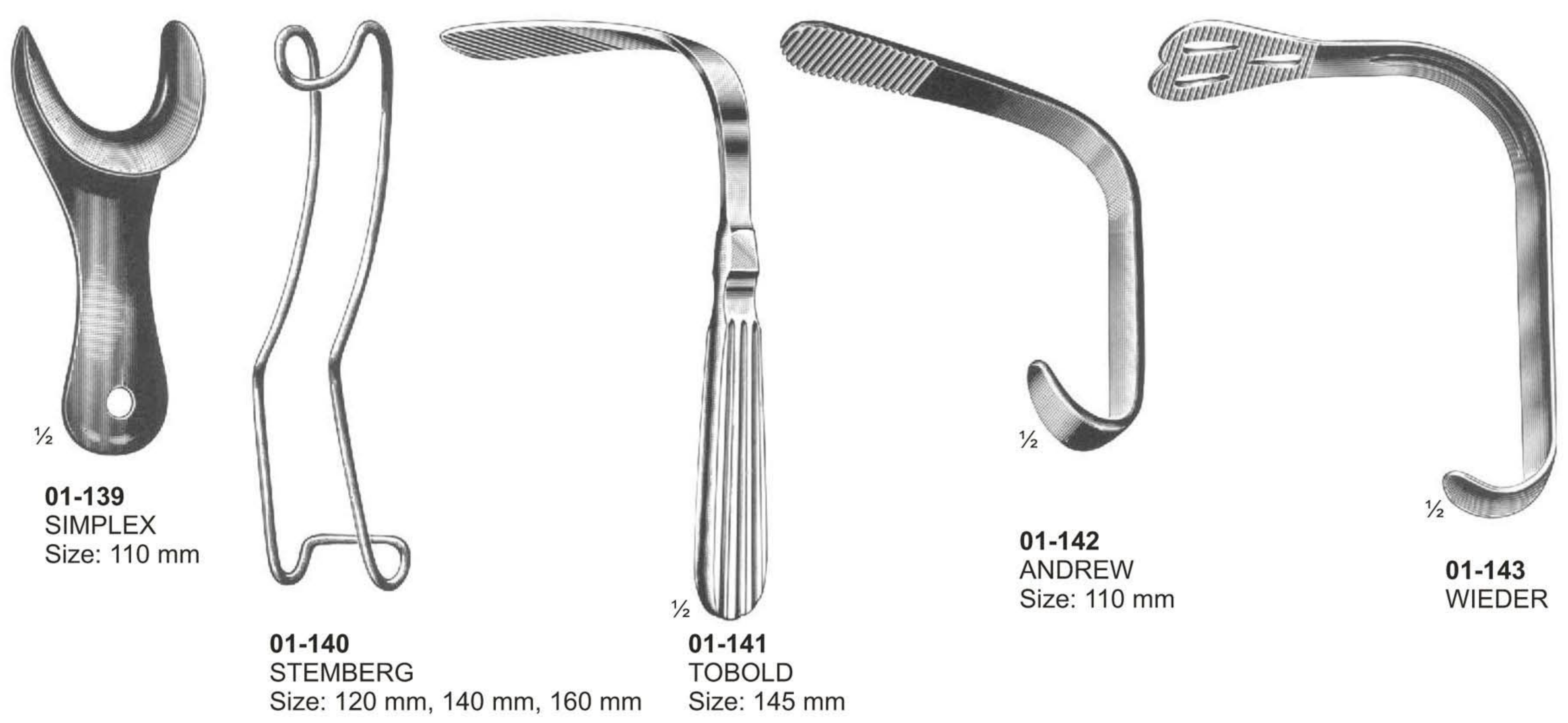
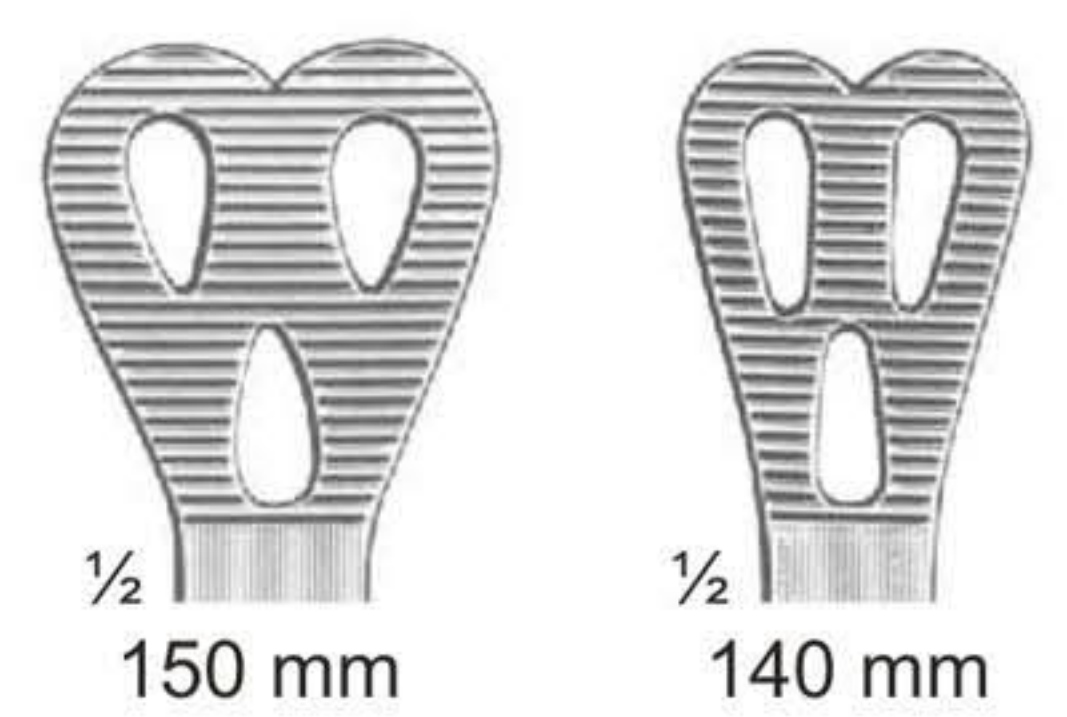
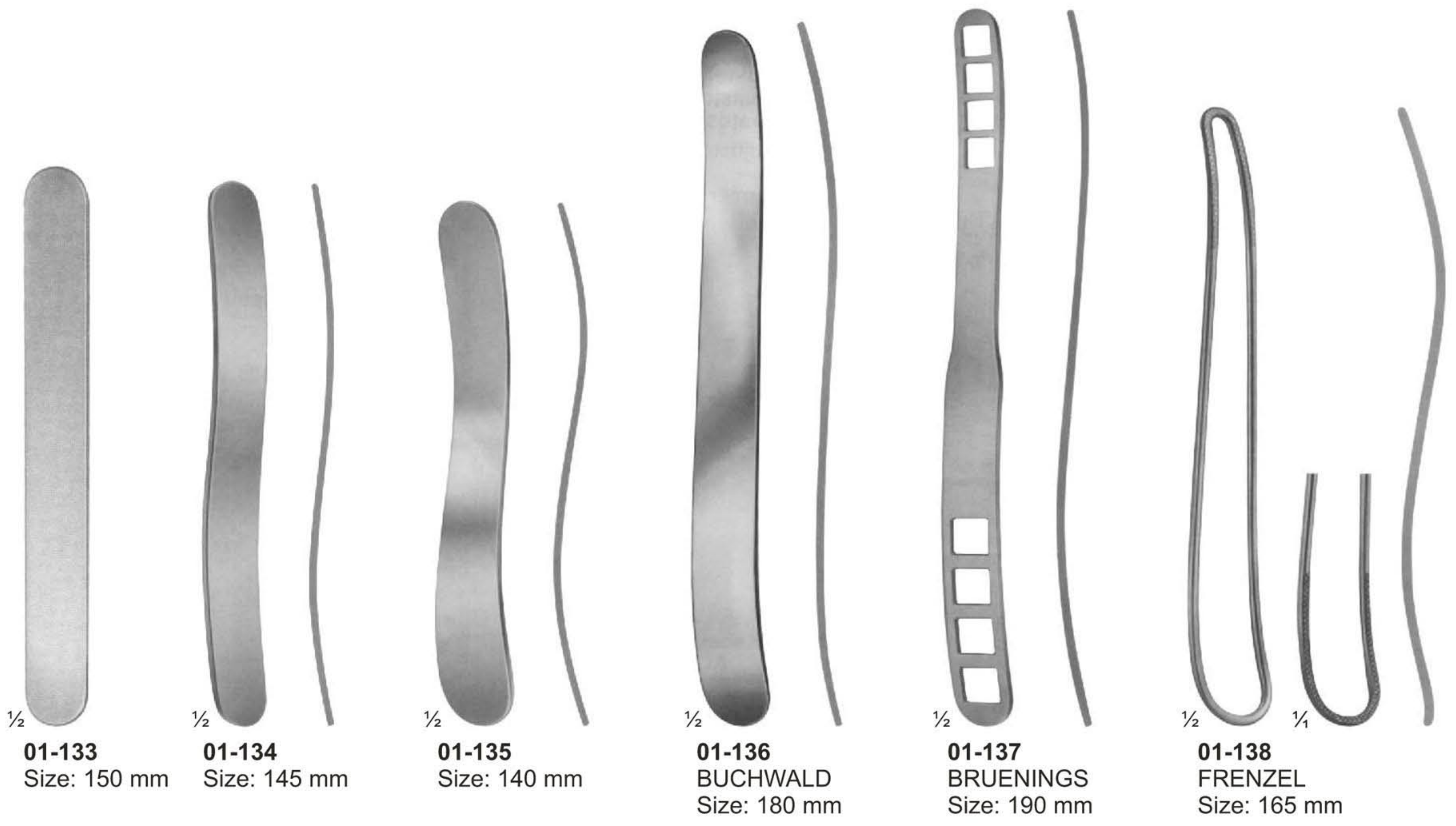



# Tongue Depressors



**01-144**  
SCHIMMELBUSCH  
Ether Mask



**01-145**  
HEISTER  
Mouth Gag  
Size: 130 mm



**01-146**  
FERGUSSON-ACKLAND  
Mouth Gag  
Size: 145 mm



**01-147**  
DENHARDT  
Mouth Gag With Silicon  
Inserts, Interchangeable  
Size: 125 mm



**01-148**  
ROSER KONIG  
Mouth Gag  
Size: 160 mm, 185 mm

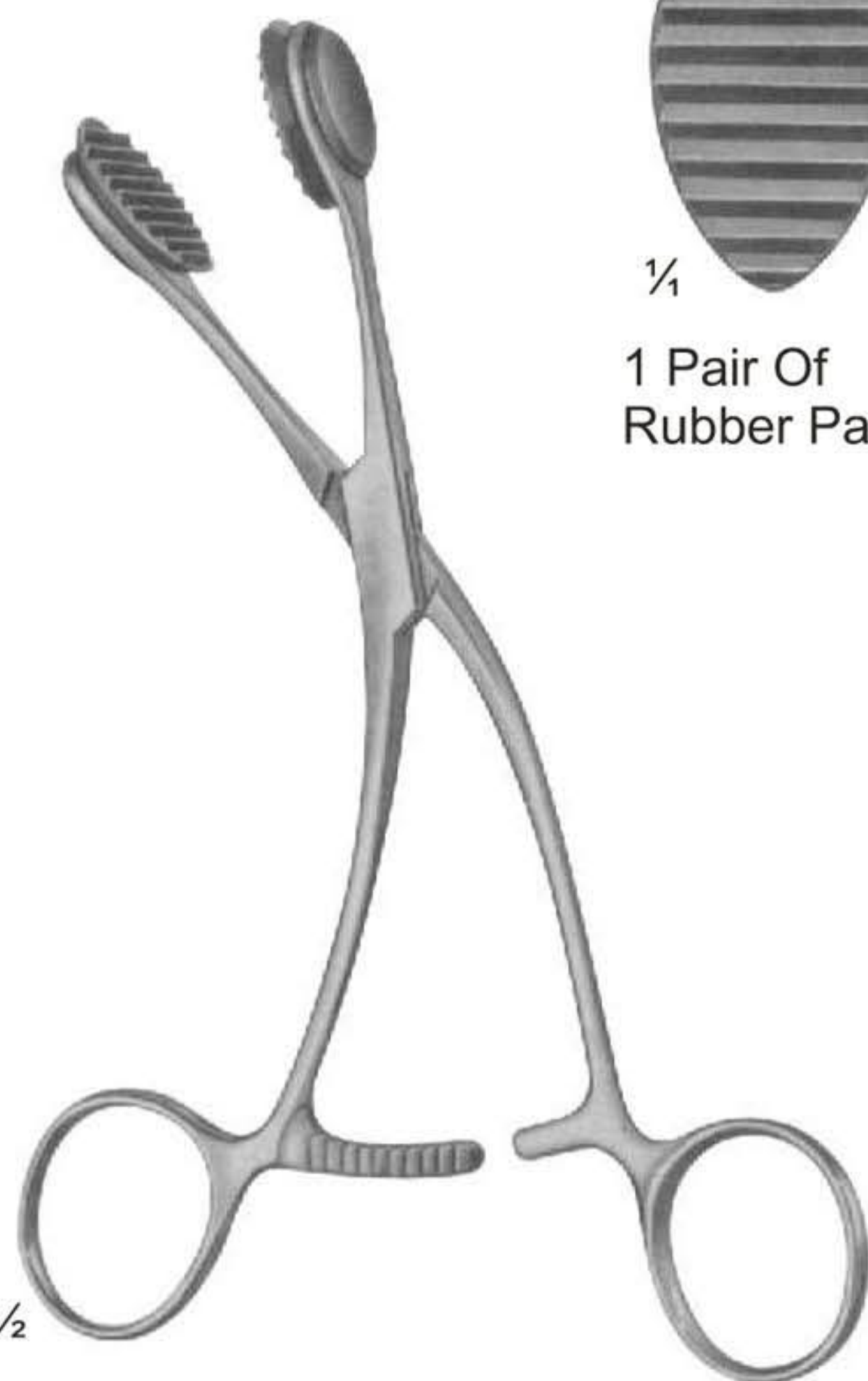

**01-149**  
YOUNG  
Size: 165 mm



1 Pair Of  
Rubber Pads

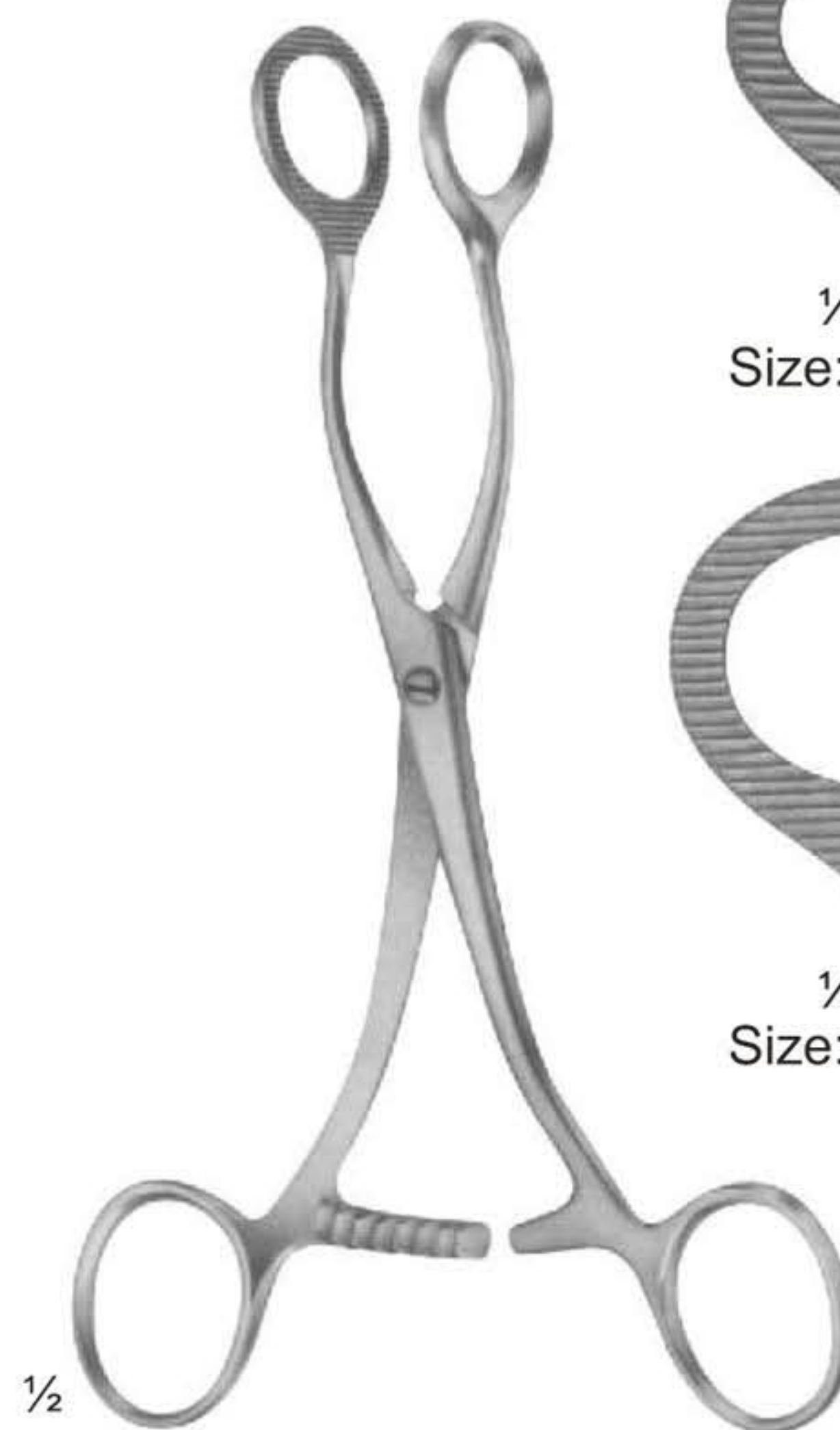

**01-150**  
COLLIN  
Size: 160 mm, 170 mm

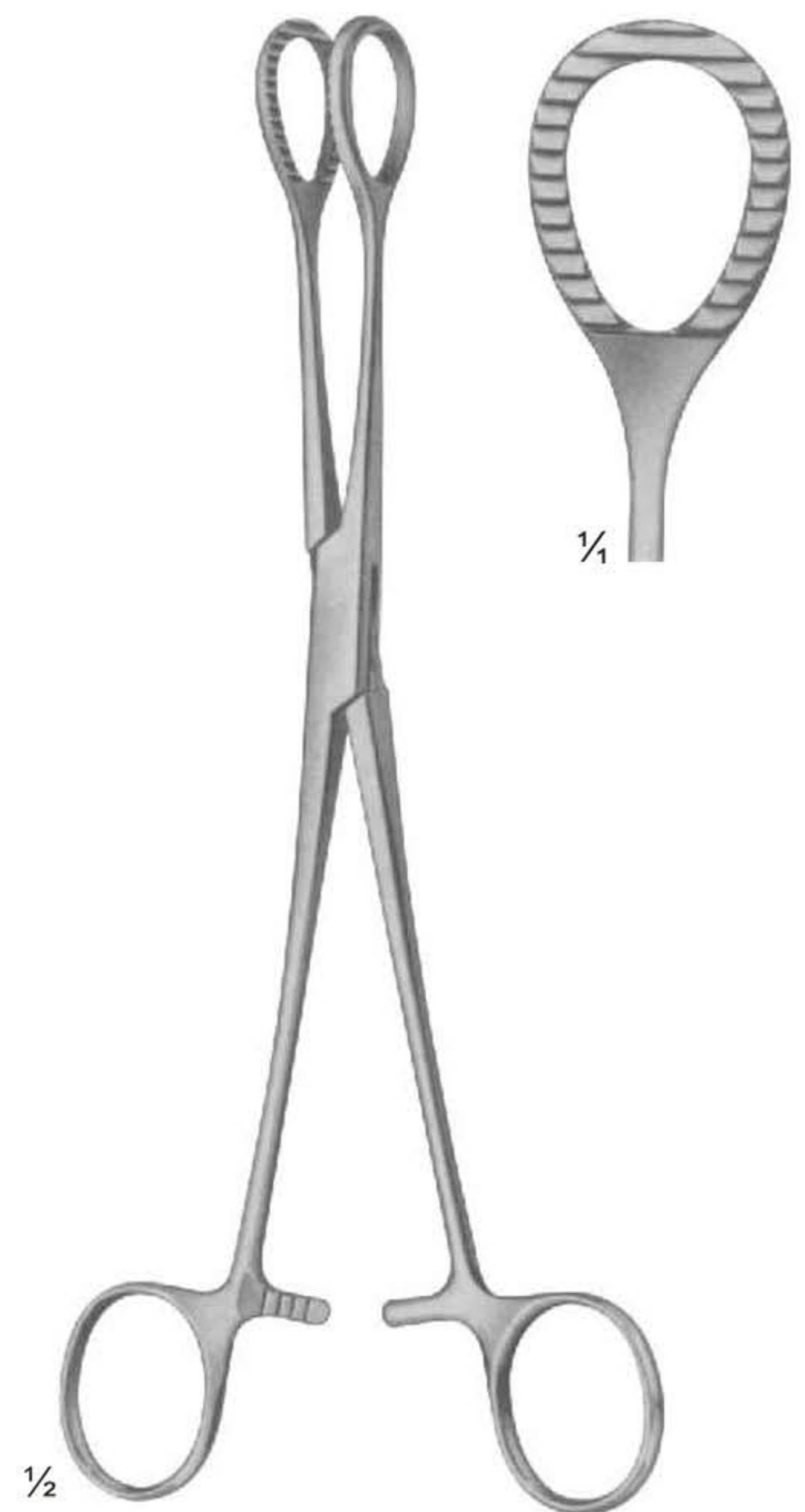

**01-151**  
HEYWOOD-SMITH modif.  
Size: 215 mm



# Blood Lancets & Laryngeal Mirrors



**01-152**  
FRANCKE  
Automatic Blood Lancet  
1/2



**01-153**  
KOLLE  
Microscopic Needle Holder  
With Plastic Handle  
Size: 240 mm

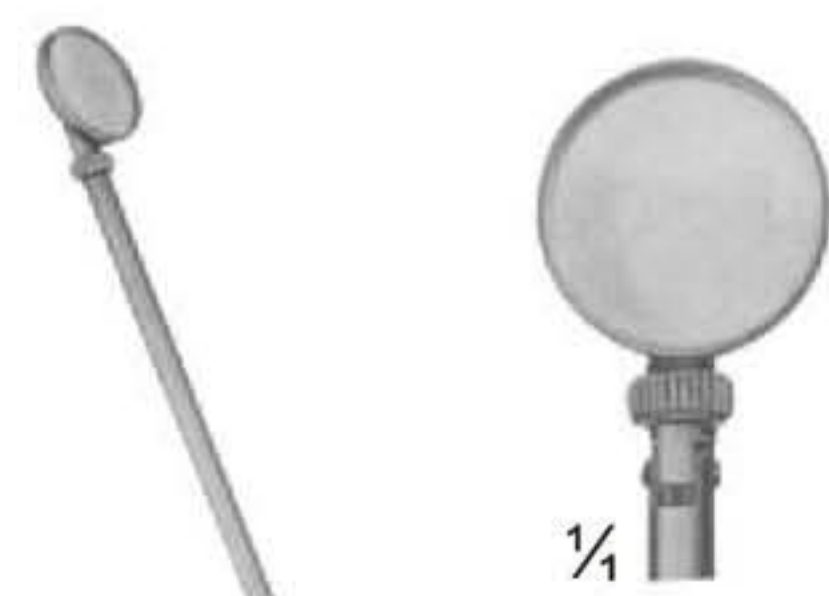
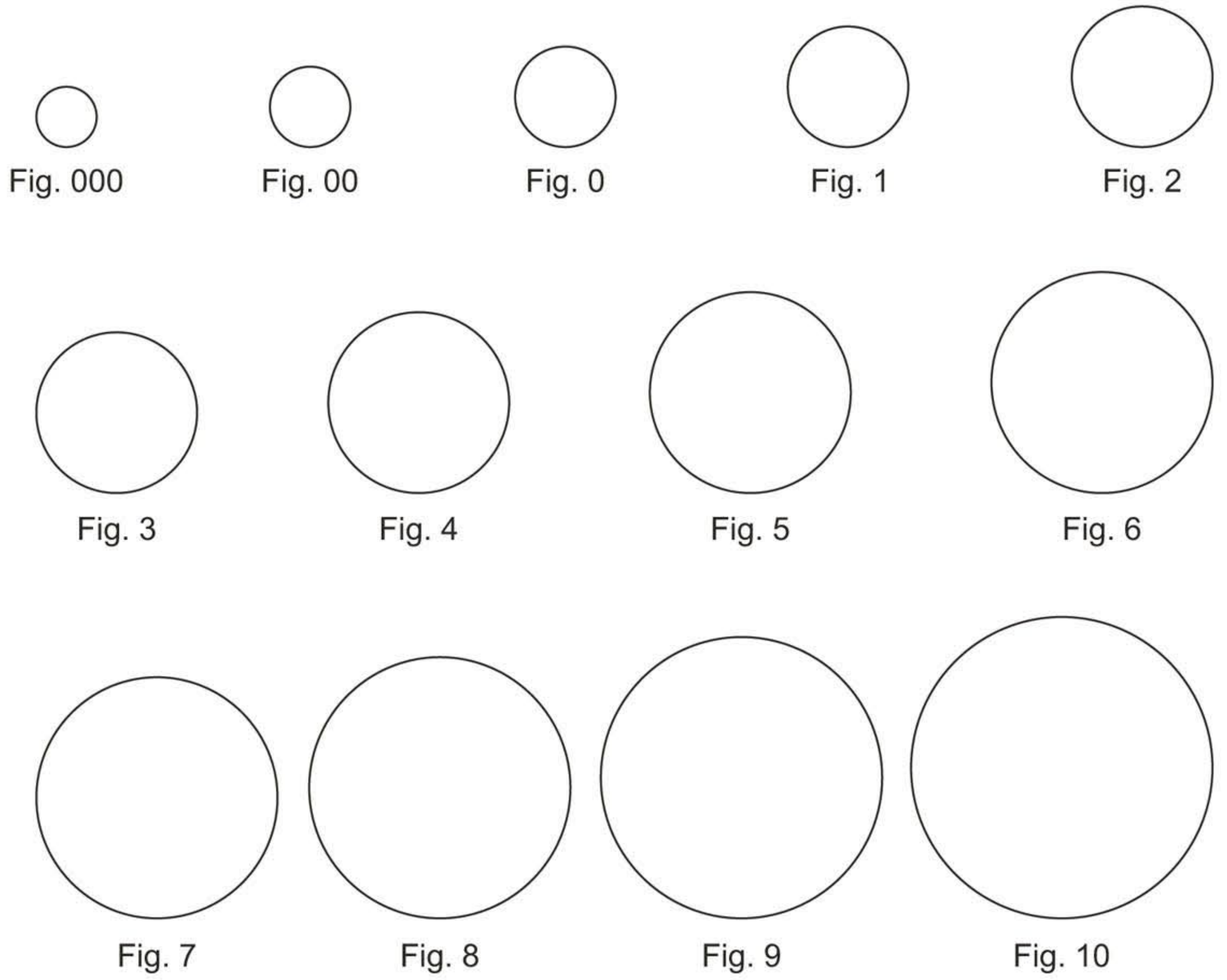

**01-158**  
Spare Mirrors Only  
Size: 12 mm  
1/4



**01-159**  
Spare Mirrors Only  
Size: 14 mm  
1/4



**01-154**  
Laryngeal Mirrors With  
Hexagonal Handle  
Size: 180 mm  
1/2



**01-155**  
Mirror Handle  
Size: 110 mm  
1/2



**01-156**  
Mirror Handle  
Size: 105 mm  
1/2



**01-157**  
MICHEL  
Rhinoscopic Mirrors With  
Interchangeable Mirror Inserts  
Size: 250 mm  
1/2



**Diagnostic Sets**



1/2

**01-160 - 162**  
MAGILL



1/4

**01-160**  
Infants  
Size: 150 mm



1/4

**01-161**  
Children  
Size: 200 mm



1/4

**01-162**  
Adults  
Size: 250 mm



1/2

**01-163**  
Medium battery handle  
only, 25 mm diam.



**01-163-A**  
Spare bulb  
2.7 volt, for  
otoscopes



**01-163-B**  
Spare bulb  
2.6 volt, for  
ophthalmoscopes



**01-164**  
Otoscope Set, Consists Of  
Battery Handle Without Batteries,  
3 Ear Specula, 1 Bulb In Velvet Lined Case



**01-165**  
Diagnostic Set, Otoscope With Three Specula,  
Nasal Speculam, Lamp Holder, Two Laryngeal  
Mirrors, Tongue Blade Holder



**Diagnostic Sets**



1/3

**01-166**  
**MILLER**  
Laryngoscope Set, Consists Of Battery Handle ( Without Battery )  
With Four Miller Laryngoscope Blades

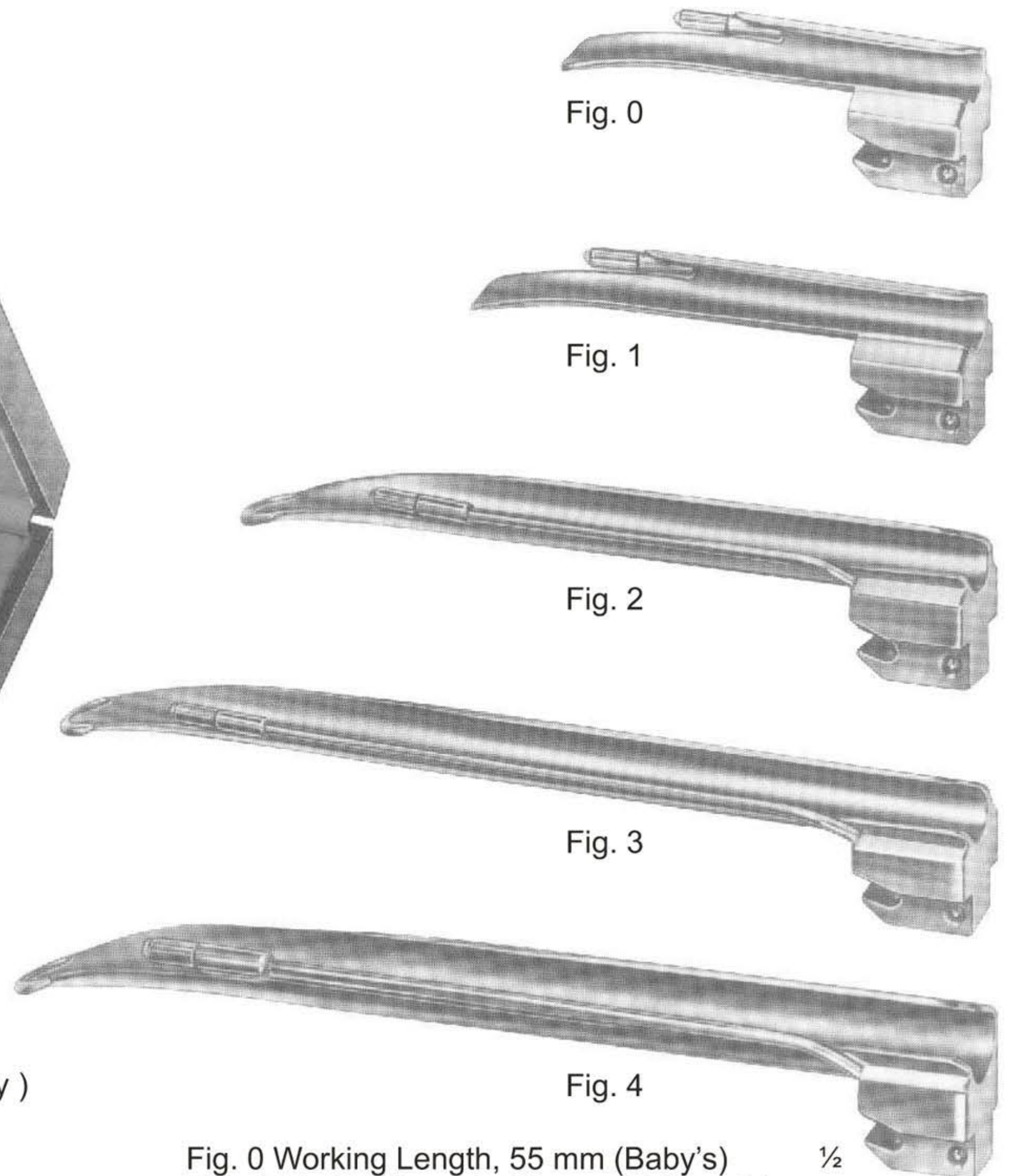

Fig. 0 Working Length, 55 mm (Baby's) 1/2  
Fig. 1 Working Length, 80 mm (Children's)  
Fig. 2 Working Length, 130 mm (Adolescent's)  
Fig. 3 Working Length, 170 mm (Women's)  
Fig. 4 Working Length, 180 mm (Men's)



1/3

**01-167**  
**GUEDEL-NEGUS**  
Laryngoscope Set, Consists Of Battery Handle ( Without Battery )  
With Four Miller Laryngoscope Blades

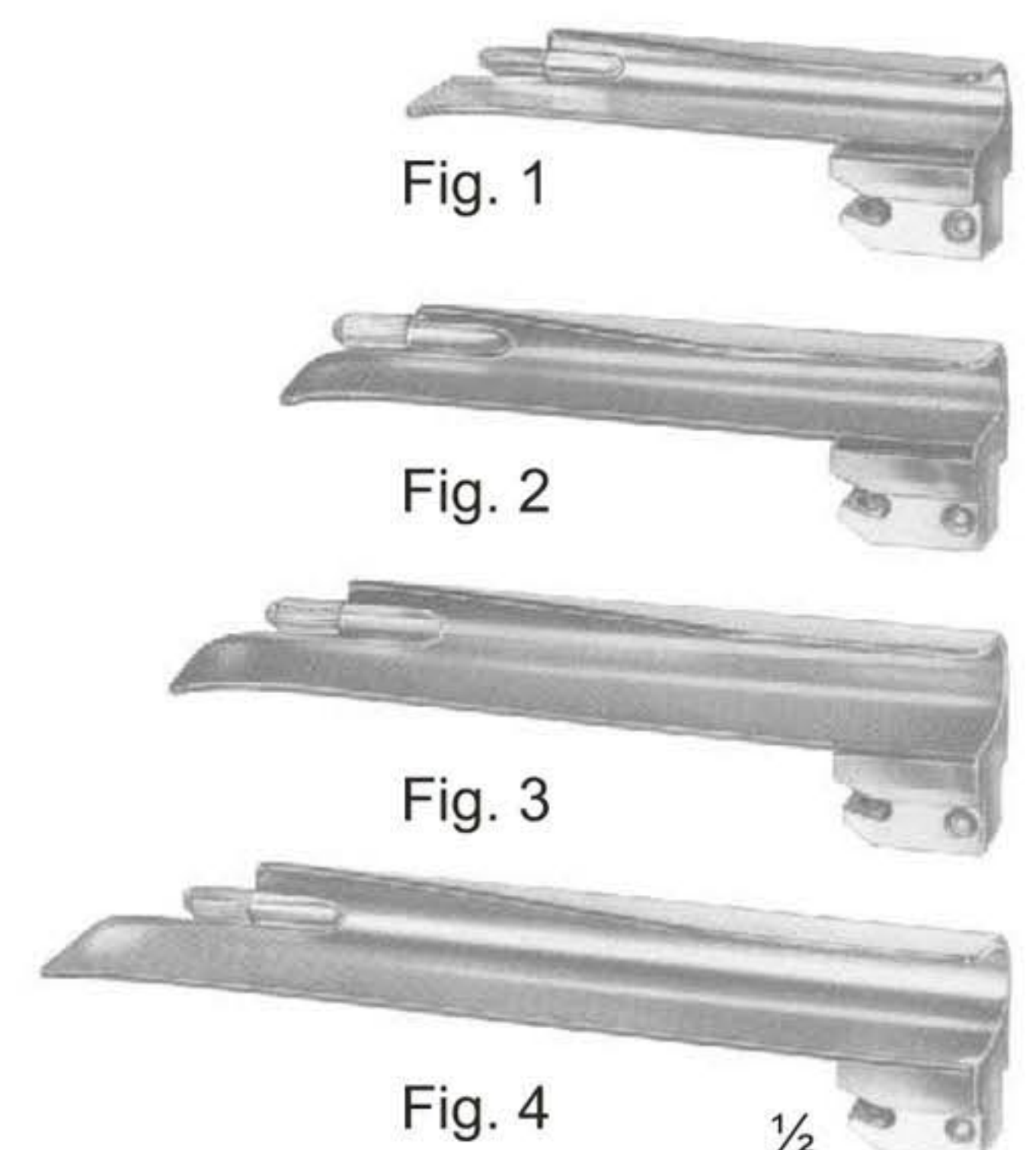

Fig. 1 Working Length, 70 mm (Children's)  
Fig. 2 Working Length, 90 mm (Adolescent's)  
Fig. 3 Working Length, 110 mm (Women's)  
Fig. 4 Working Length, 135 mm (Men's)



## Diagnostic Sets



**01-168**  
McIntosh  
Laryngoscope Set, Consists Of Battery Handle ( Without Battery )  
With Three McIntosh Blades, Fig. 1, Fig. 2, Fig. 3

**01-169**  
McIntosh  
Laryngoscope Set, Consists Of Battery Handle ( Without Battery )  
With Five McIntosh Blades, Fig. 1, Fig. 2, Fig. 3, Fig. 4, Fig. 5



Fig. 0



Fig. 1



Fig. 2



Fig. 3

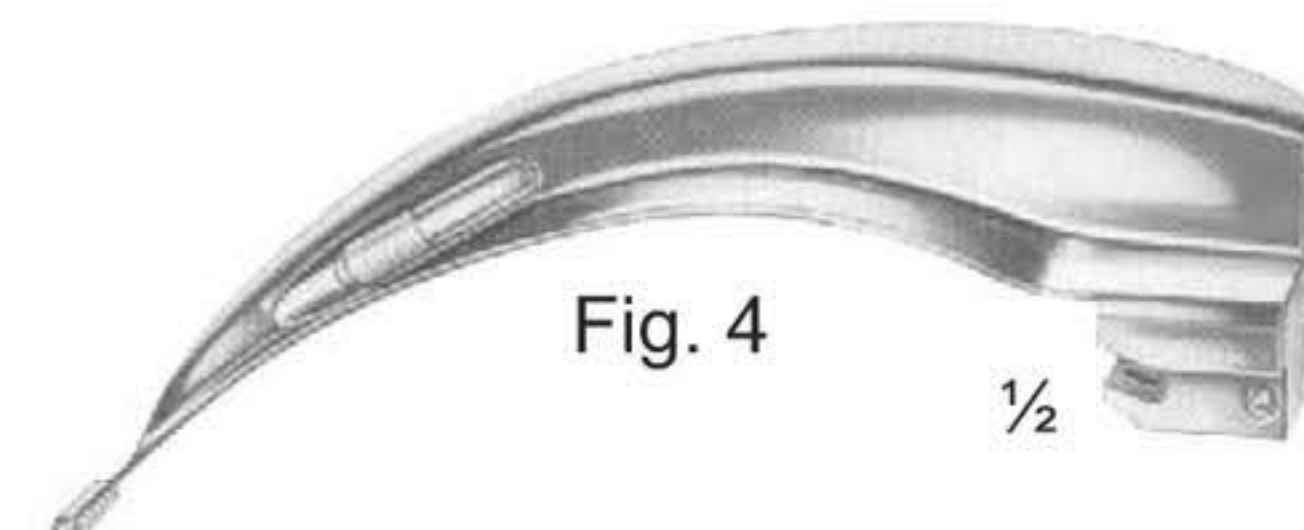
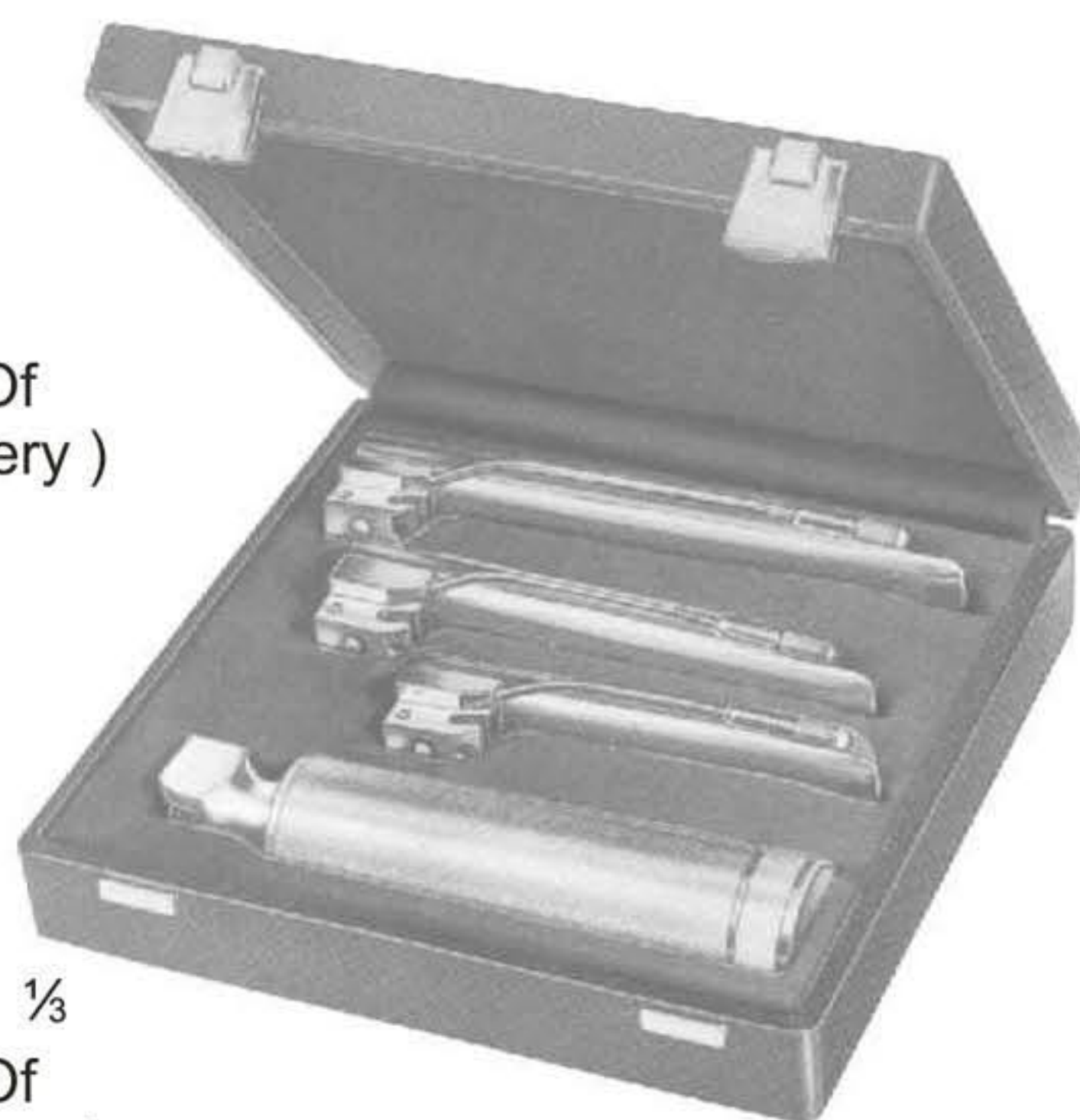

Fig. 4

Fig. 0 Working Length, 55 mm (Baby's)  
Fig. 1 Working Length, 75 mm (Children's)  
Fig. 2 Working Length, 90 mm (Adolescent's)  
Fig. 3 Working Length, 110 mm (Women's)  
Fig. 4 Working Length, 135 mm (Men's)

**01-170**  
FOREGGER  
Laryngoscope Set, Consists Of  
Battery Handle ( Without Battery )  
With Three Foregger Blades,  
Fig. 1, Fig. 2, Fig. 3,



**01-171**  
FOREGGER  
Laryngoscope Set, Consists Of  
Battery Handle ( Without Battery )  
With Five Foregger Blades,  
Fig. 1, Fig. 2, Fig. 3, Fig. 4, Fig. 5



Fig. 1



Fig. 2



Fig. 3

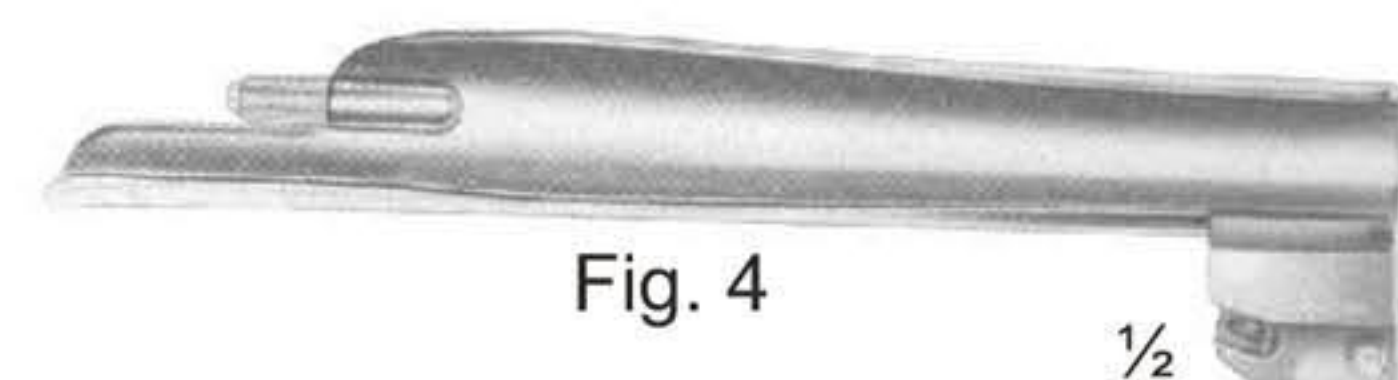
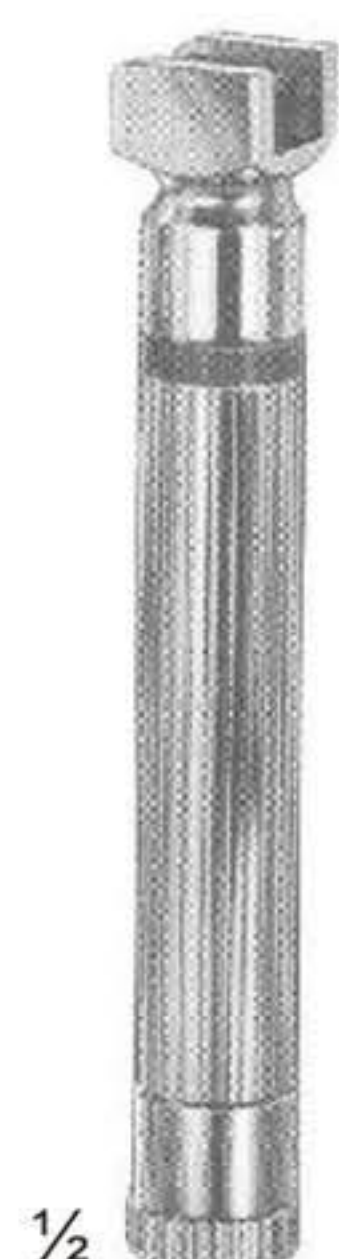

Fig. 4

Fig. 1 Working Length, 70 mm (Children's)  
Fig. 2 Working Length, 90 mm (Adolescent's)  
Fig. 3 Working Length, 110 mm (Women's)  
Fig. 4 Working Length, 135 mm (Men's)



**01-172**  
Fiber Optic  
Battery Handle



**01-173**  
Fiber Optic  
Battery Handle



**01-174**  
Replacement Lamp  
( Krypton ) 2.5 V



**01-175**  
Replacement Lamp  
( Halogen ) 2.5 V



**Examination & Measuring Instruments**

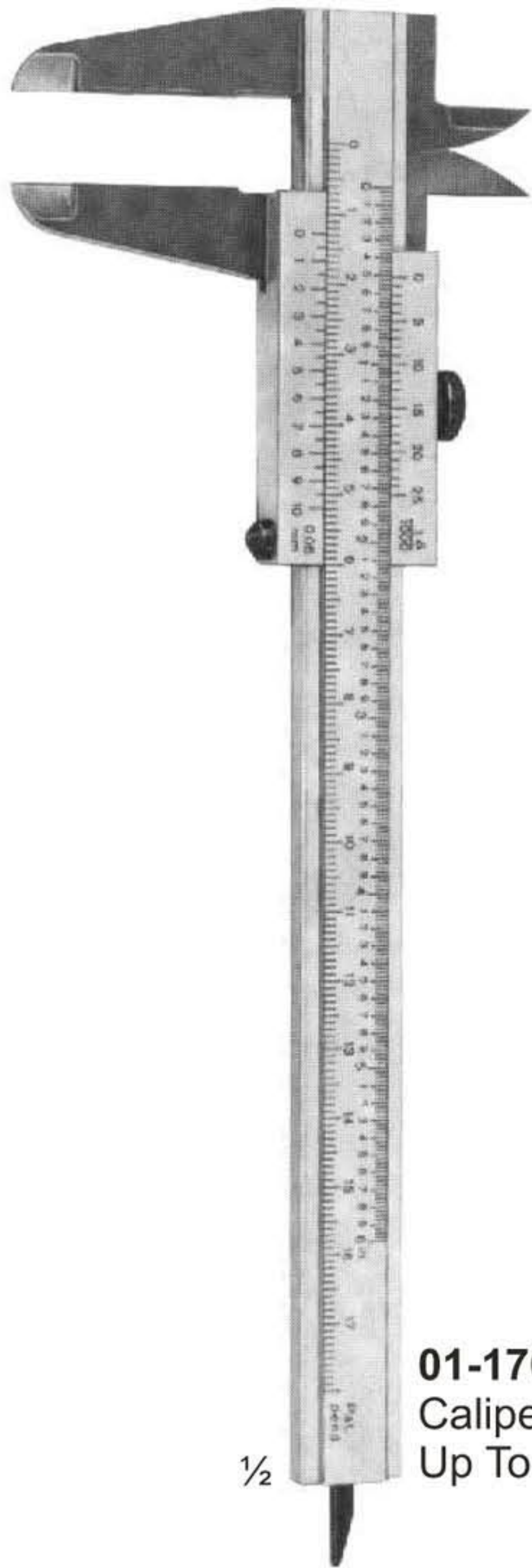

**01-176**  
Caliper Of Aluminum  
Up To 180 mm



**01-177**  
VERNIER  
Universal Caliper Of Steel  
Up To 120 mm

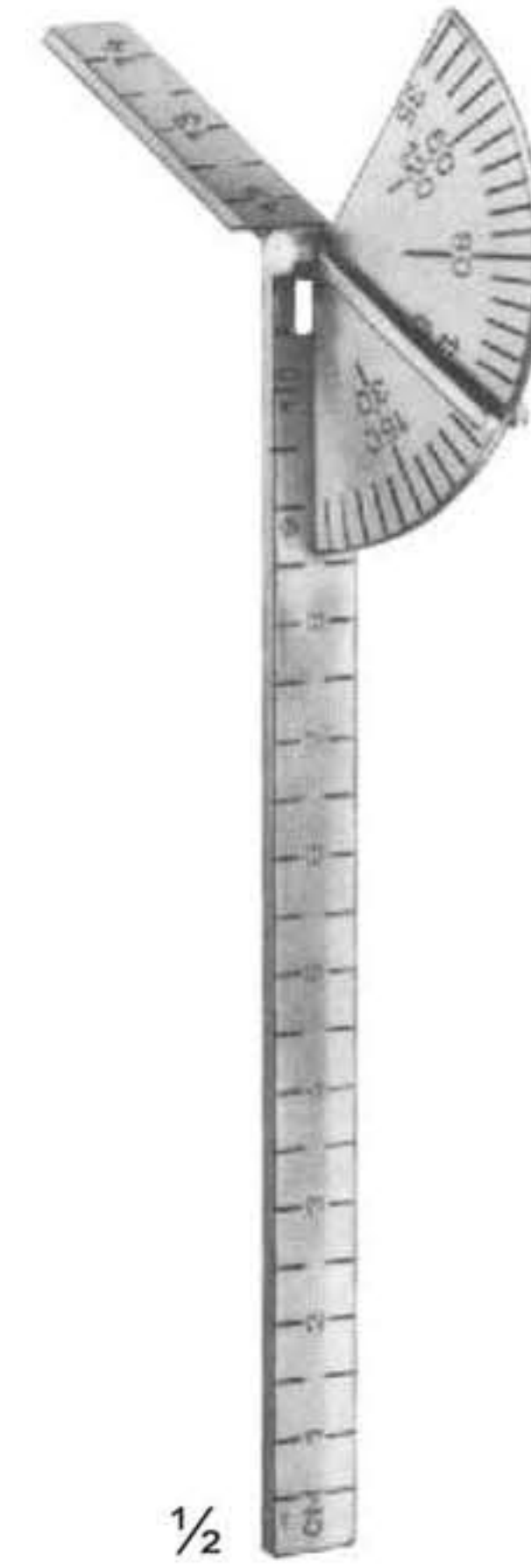

**01-178**  
CAROLL  
Size: 140 mm



**01-179**  
TOWNLEY  
Size: 100 mm

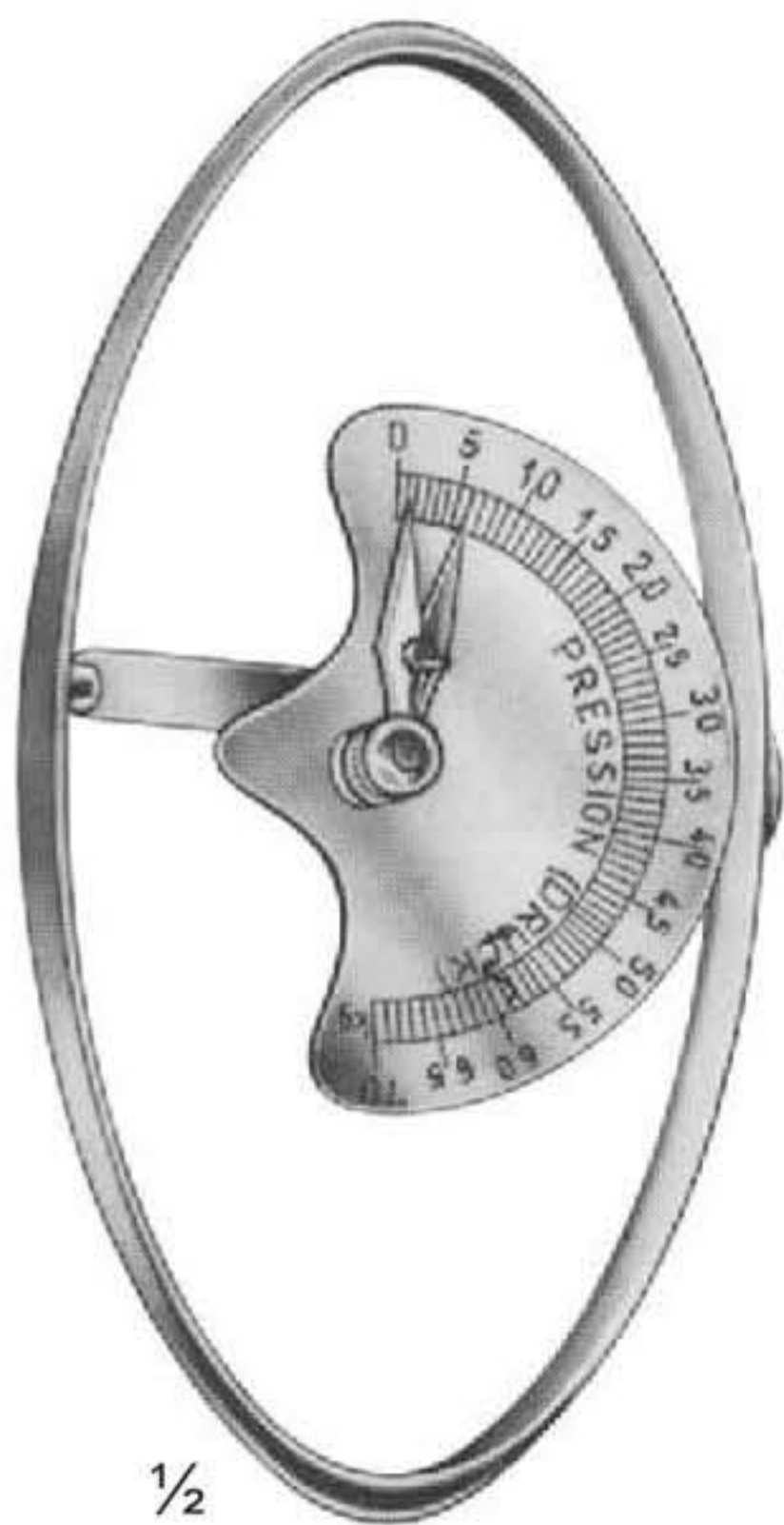

**01-180**  
COLLIN  
Druck Pressure 72 kg  
Size: 125 mm

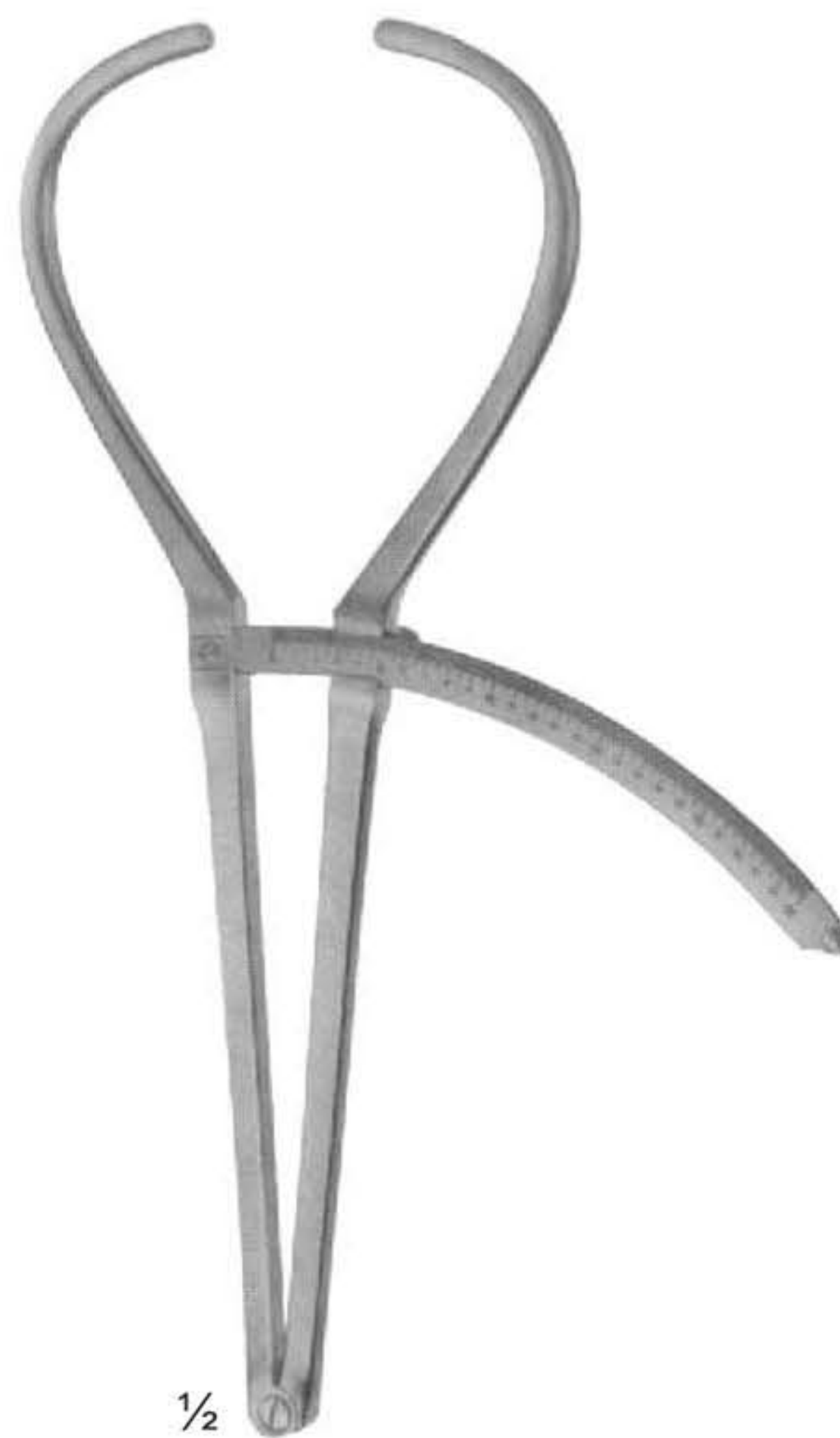

**01-181**  
BERTILLON  
Caliper For Measuring The Head  
Size: 320 mm



**01-182**  
CASTROVIEJO  
Caliper



**01-183**  
MOLTGEN  
Goniometer

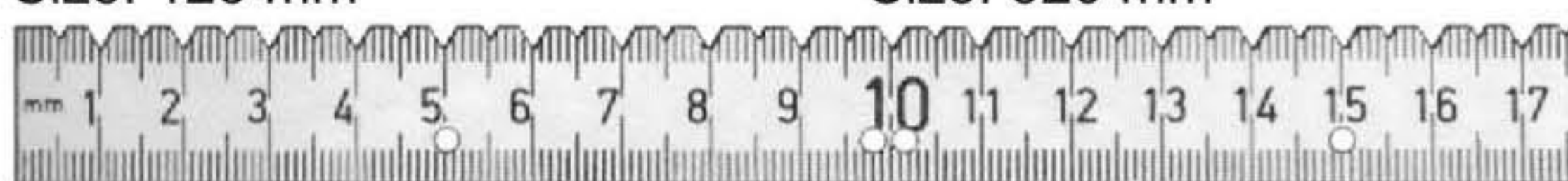

**01-184**  
Size: 500 mm



# Dissecting Knives



**02-101 - 110**  
Fig. 1 - 10



**02-101**  
Fig. 1

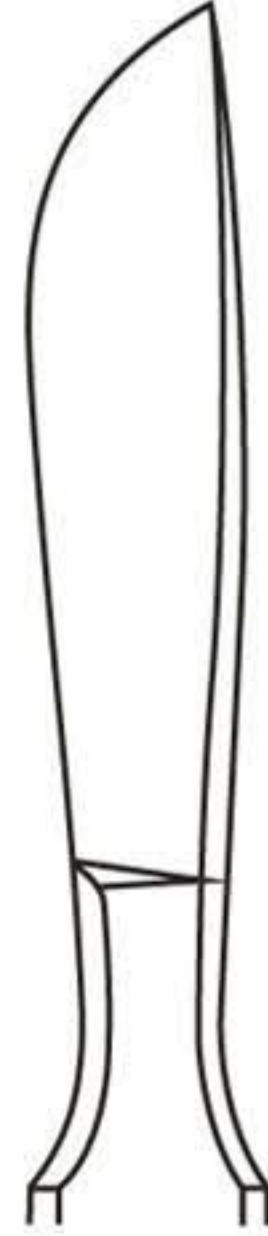

**02-102**  
Fig. 2

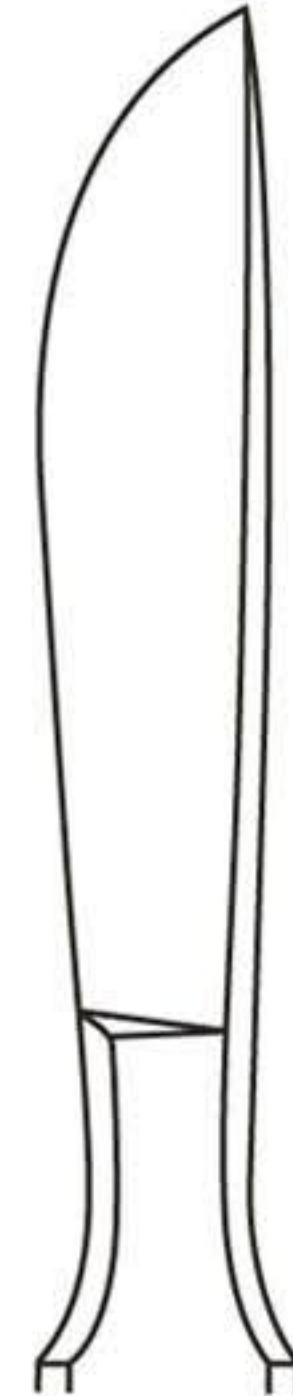

**02-103**  
Fig. 3



**02-104**  
Fig. 4



**02-105**  
Fig. 5



**02-106**  
Fig. 6

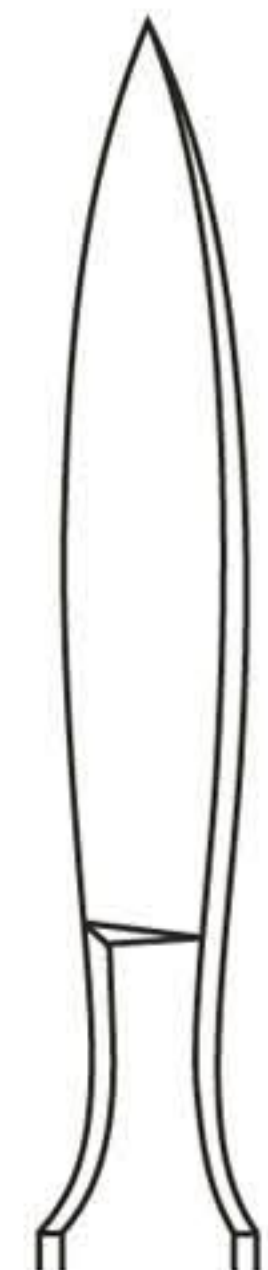

**02-107**  
Fig. 7

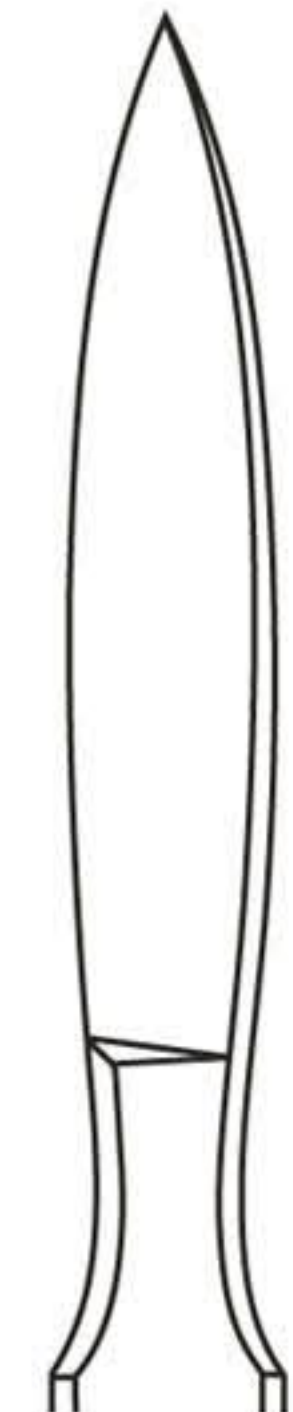

**02-108**  
Fig. 8



**02-109**  
Fig. 9



**02-110**  
Fig. 10



**Autopsy & Cartilage Knives**



$\frac{1}{2}$   
**02-111**  
Size: 255 mm

**02-112**  
VIRCHOW

**02-113 - 115**  
WALB

**02-116 - 118**  
VIRCHOW



Scalpels, Tenotomes & Resection Knives

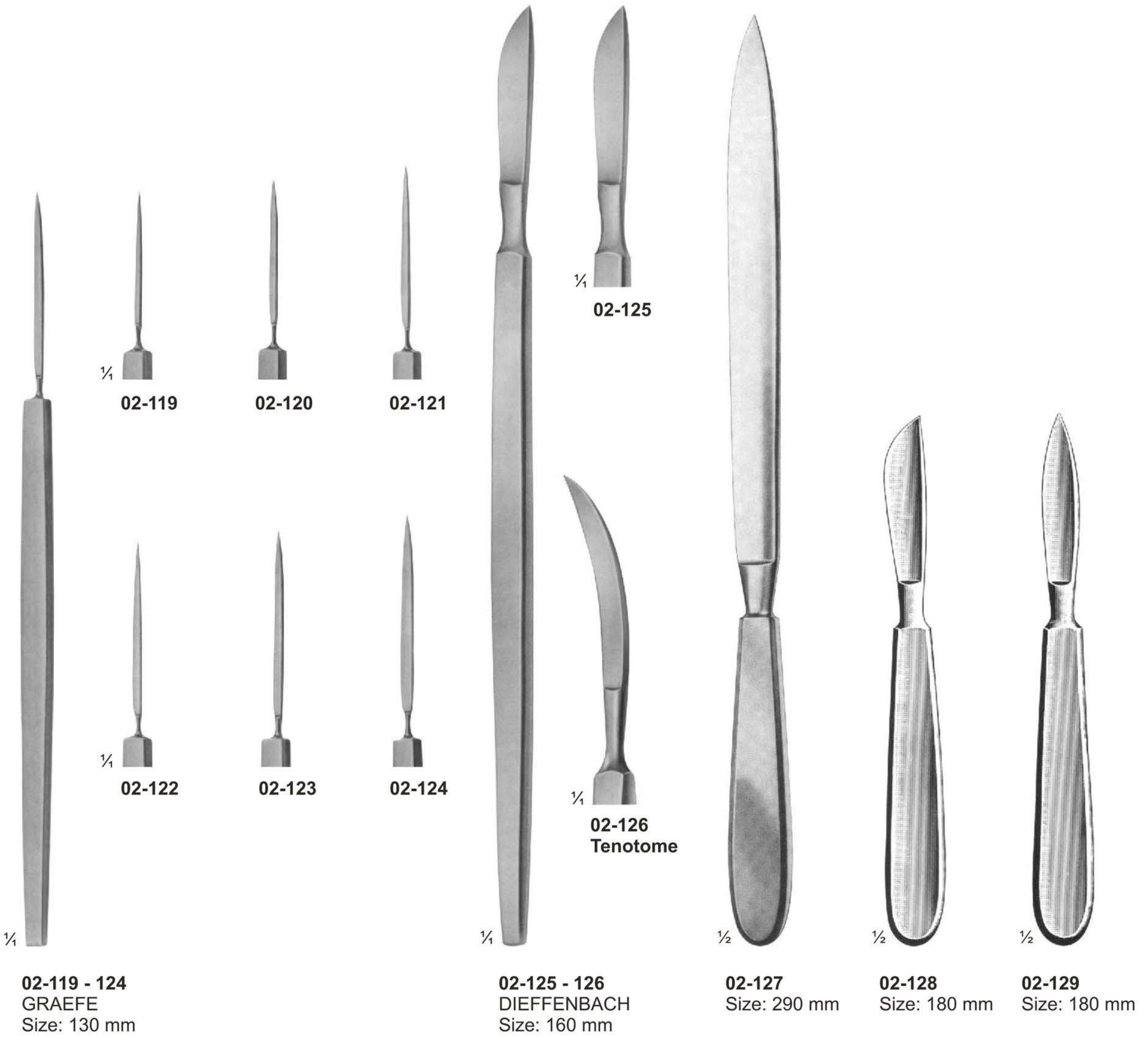



# Scalpels, Tenotomes

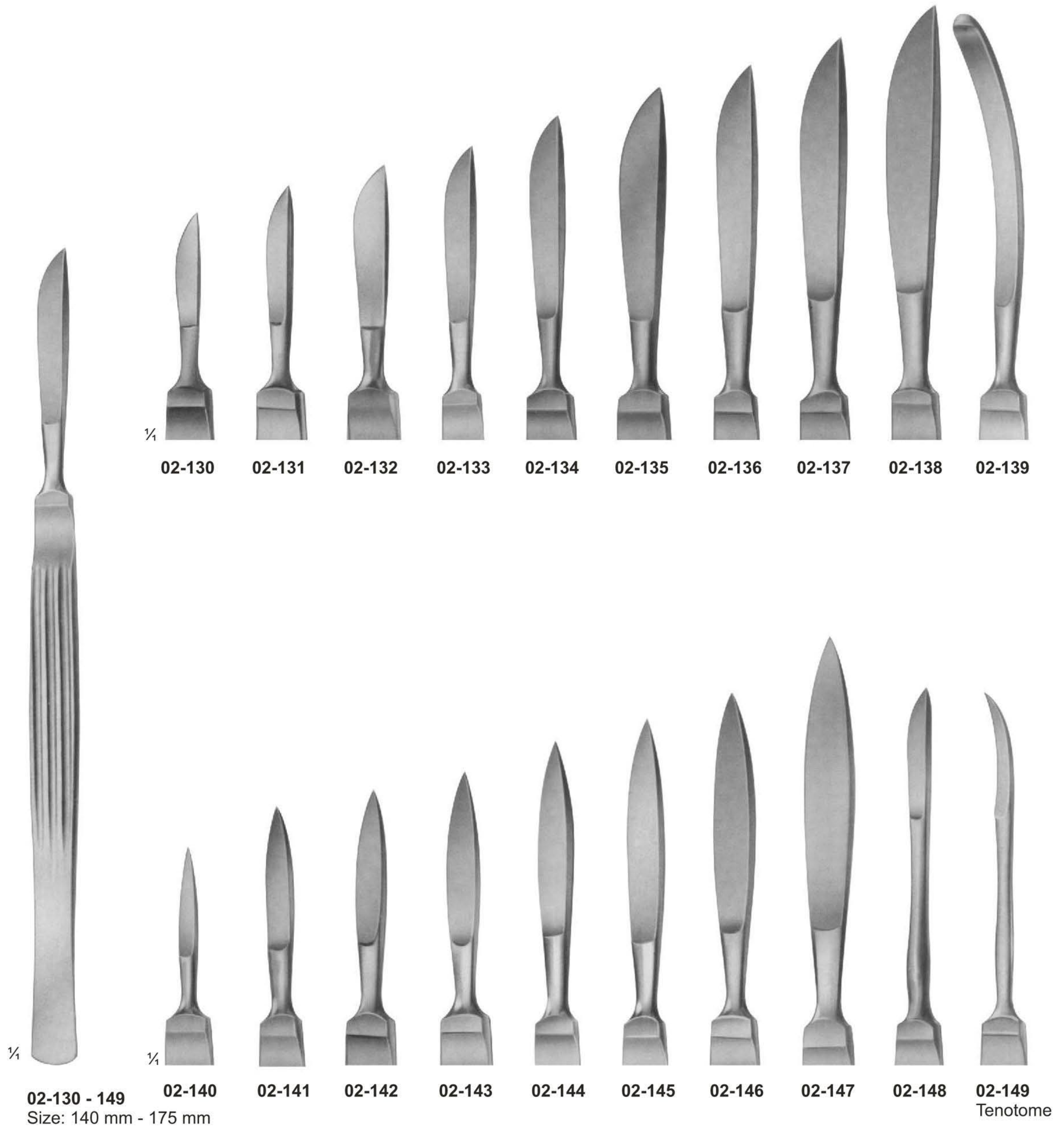



# Amputating Knives, Cartilage Knives, Autopsy Knives



**02-150**  
 Size: 130 mm  
**02-151**  
 Size: 160 mm  
**02-152**  
 Size: 190 mm  
**02-153**  
 Size: 200 mm

**02-154**  
 CATLIN  
 Size: 160 mm  
 Blade Length  
 Amputating  
 Knives

**02-155**  
 LANGENBECK  
 Size: 120 mm  
 Blade Length  
 Flap Knives

**02-156**  
 Size: 110 mm  
 Blade Length  
 Interosseous  
 Knives

**02-157**  
 Size: 55 mm  
 Blade Length  
 With Raspatory,  
 Wooden Handle

**02-158**  
 Size: 70 mm  
 Blade Length  
 Wooden Handle

**02-159**  
 Size: 80 mm  
 Blade Length  
 Metal Handle

**02-160**  
 Size: 195 mm  
 Blade Length  
 Metal Handle

Blade Length  
 Amputating Knives



## Cone Knives, Myomatome, Trigeminal & Tonsil Knives





# Scalpels, Dura Knives & Comedone Extractors

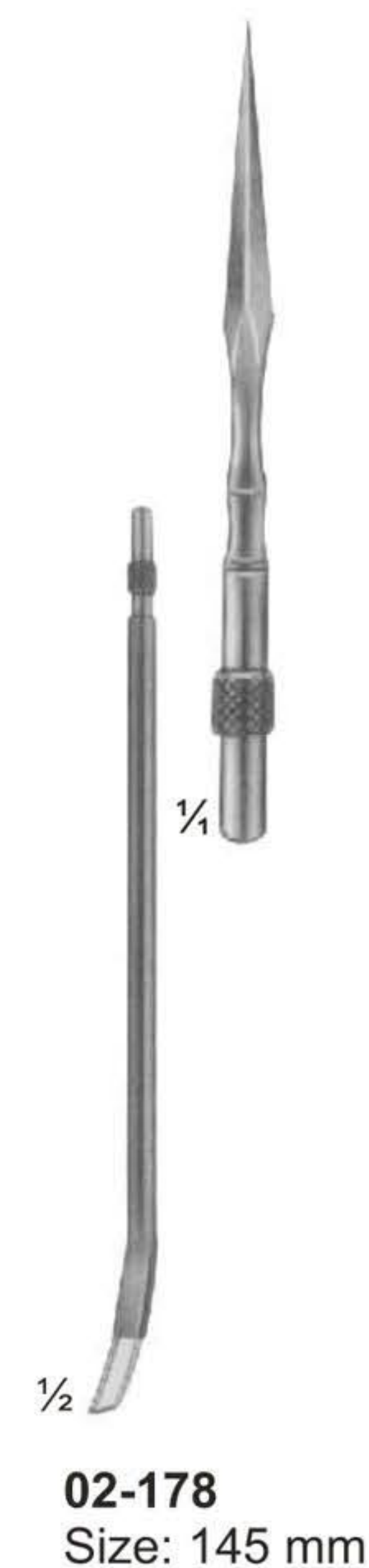
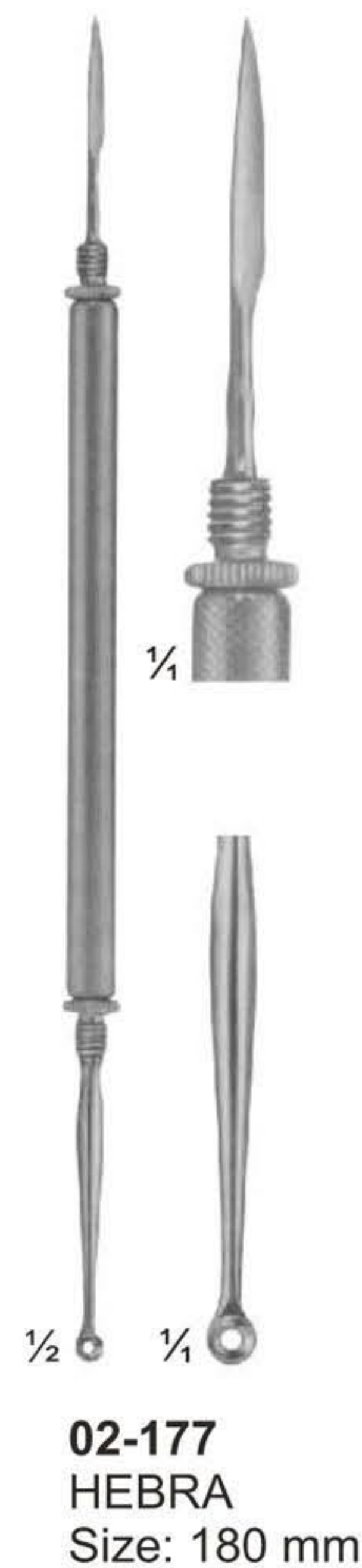
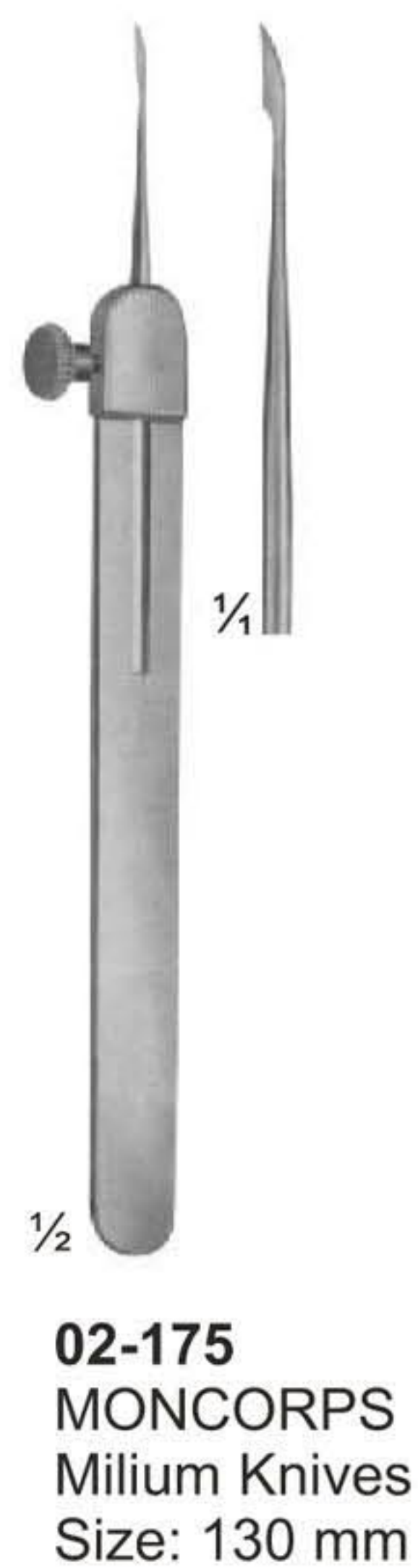
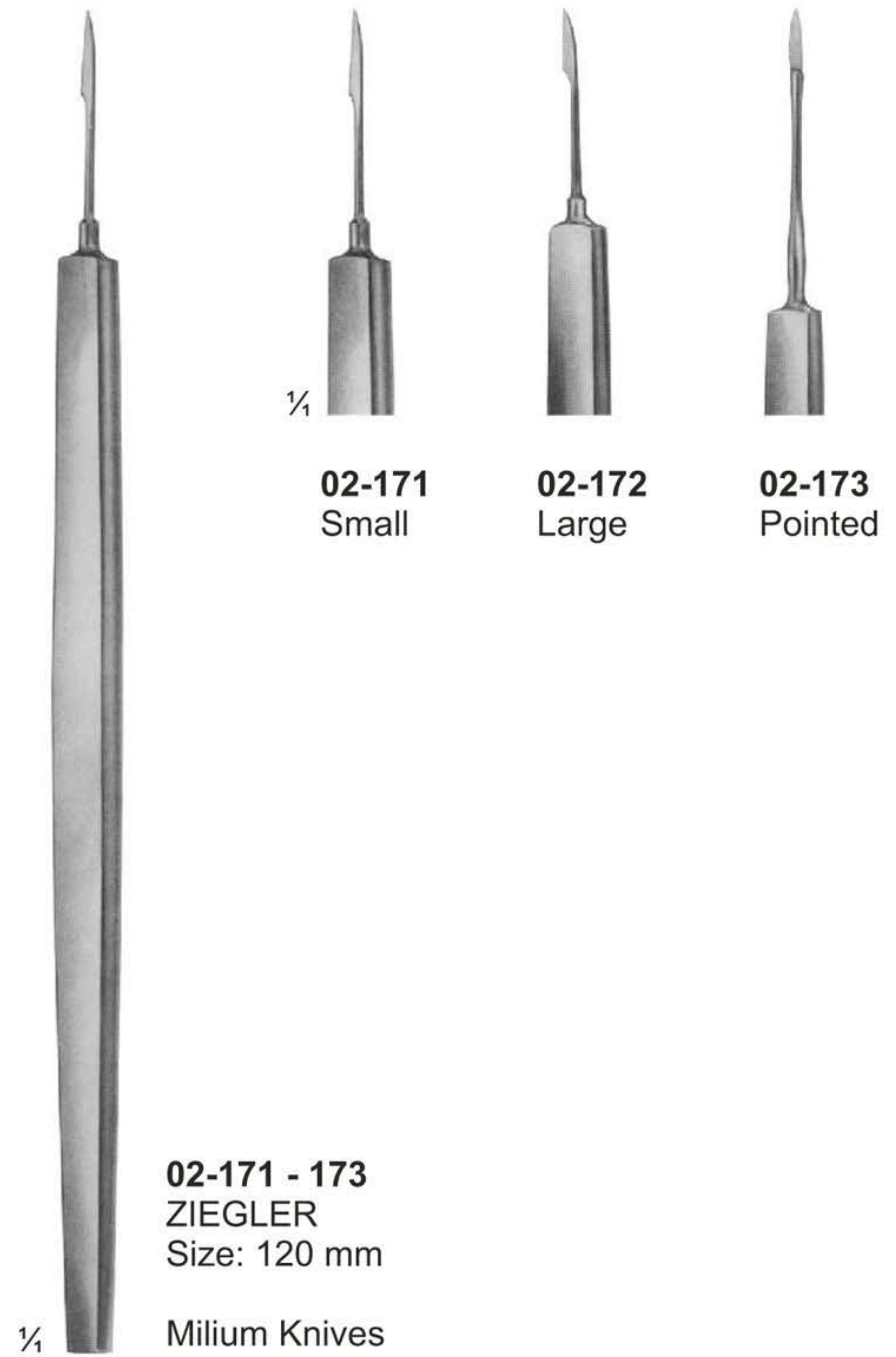
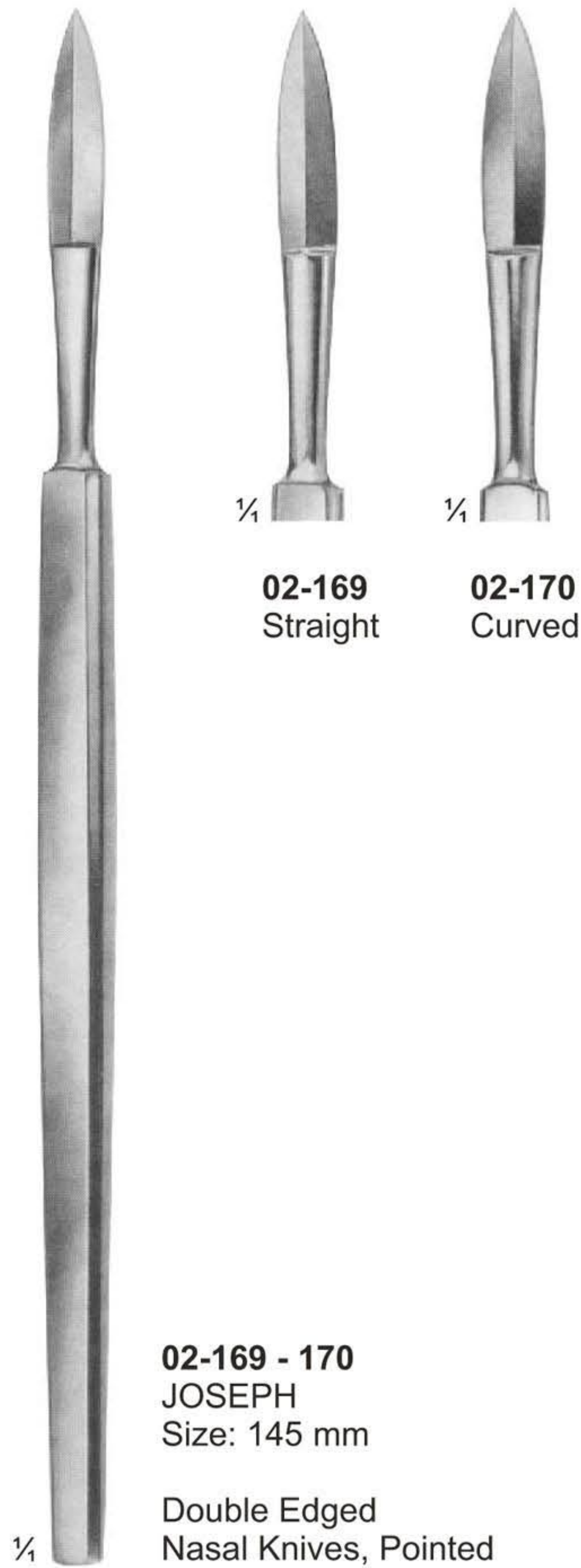



Razor Blade Holders & Breakers



1/4  
**02-180**  
TROUTMAN-CHRIS  
Size: 100 mm

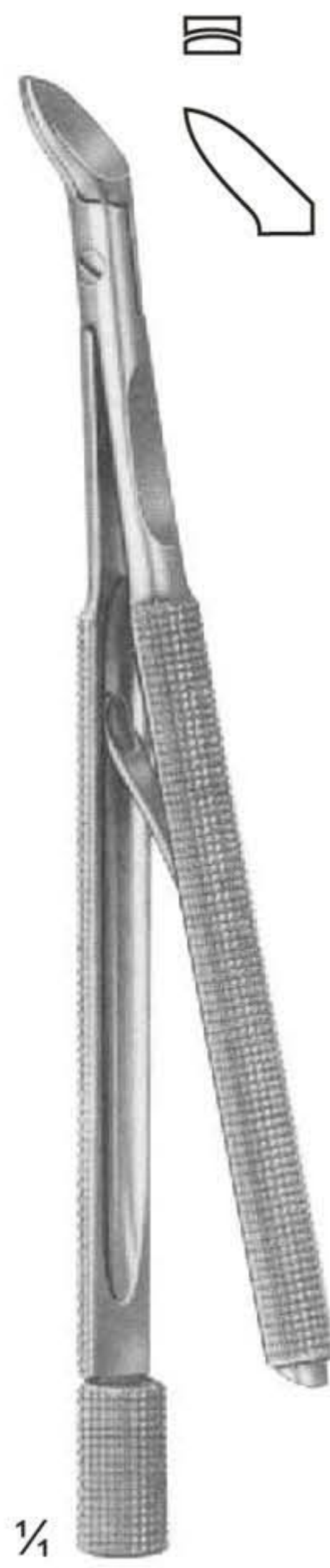

1/4  
**02-181**  
TROUTMAN-CHRIS  
Size: 100 mm



1/4  
**02-182**  
Size: 110 mm



1/4  
**02-183**  
CASTROVIEJO  
Size: 130 mm



1/4  
**02-184**  
Size: 185 mm



Scalpel Handles

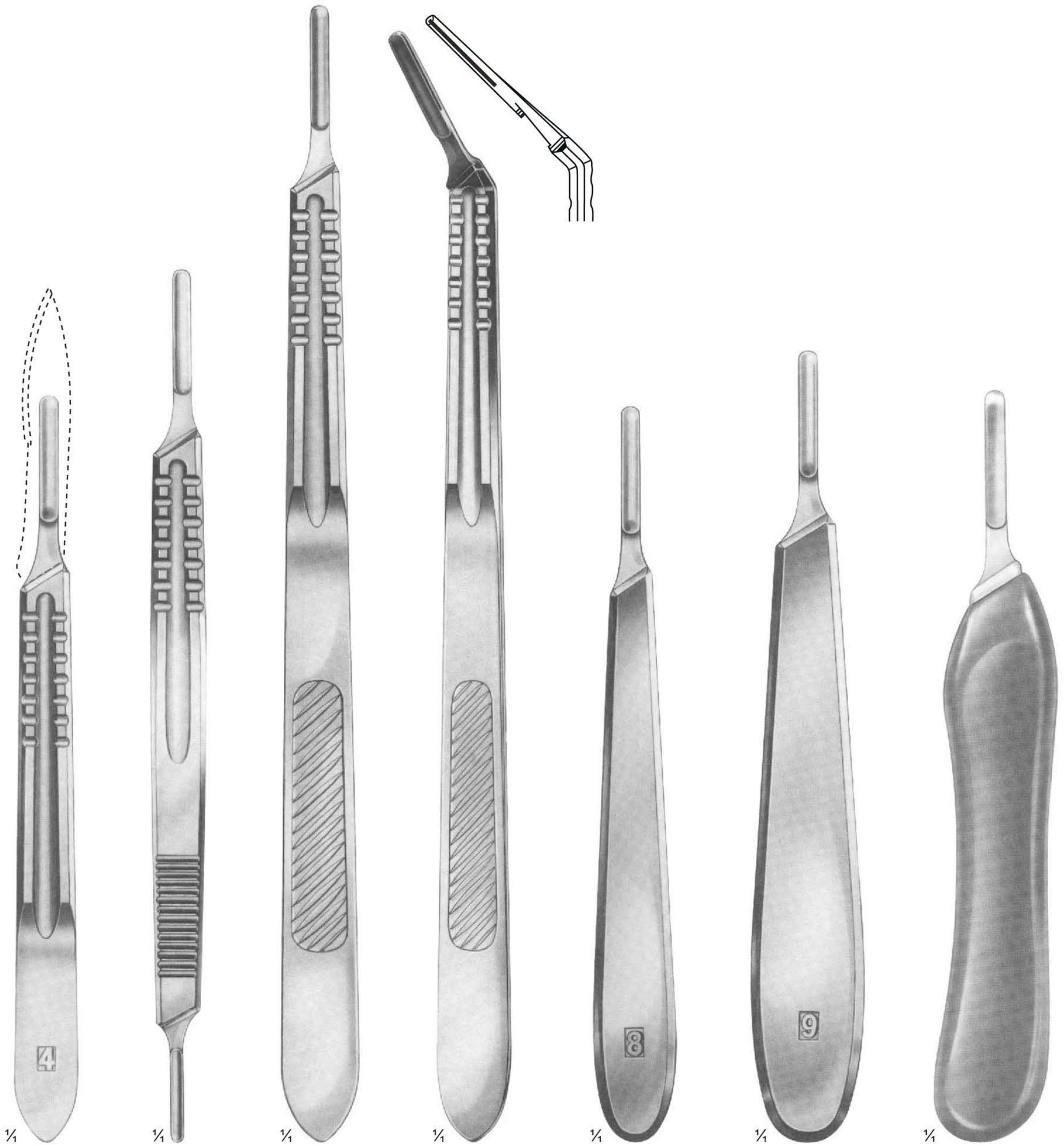

**02-185**  
STANDARD  
No. 4  
Solid

**02-186**  
Double Handel  
No. 4 + No. 3  
Solid

**02-187**  
No. 4 L  
Straight  
Solid

**02-188**  
No. 4 L  
Solid Angled

**02-189**  
COLLIN  
No. 8  
Hollow

**02-190**  
COLLIN  
No. 9  
Hollow

**02-191**  
Plastic



# Scalpel Handles

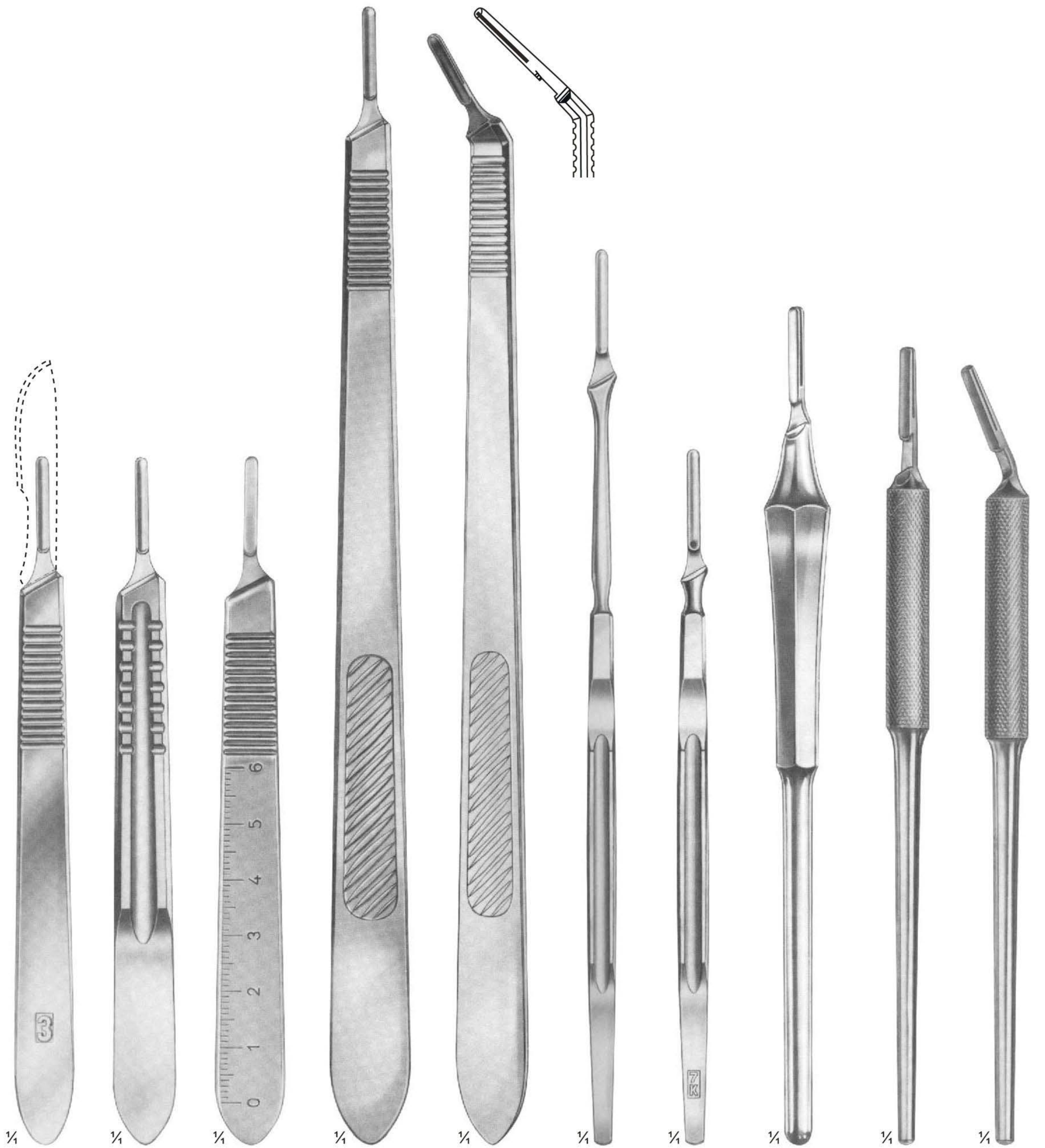

**02-192**  
STANDARD  
No. 3  
Solid

**02-193**  
No. 3  
Solid

**02-194**  
No. 3  
Solid

**02-195**  
No. 3 L  
Straight  
Solid

**02-196**  
No. 3 L  
Angled  
Solid

**02-197**  
No. 7  
Solid

**02-198**  
No. 7 K  
Solid

**02-199**  
Hollow-Round

**02-200**  
No. 3  
Straight  
Solid

**02-201**  
No. 3  
Angled  
Solid



# Micro Scissors, "Spring Type" Flat Handles

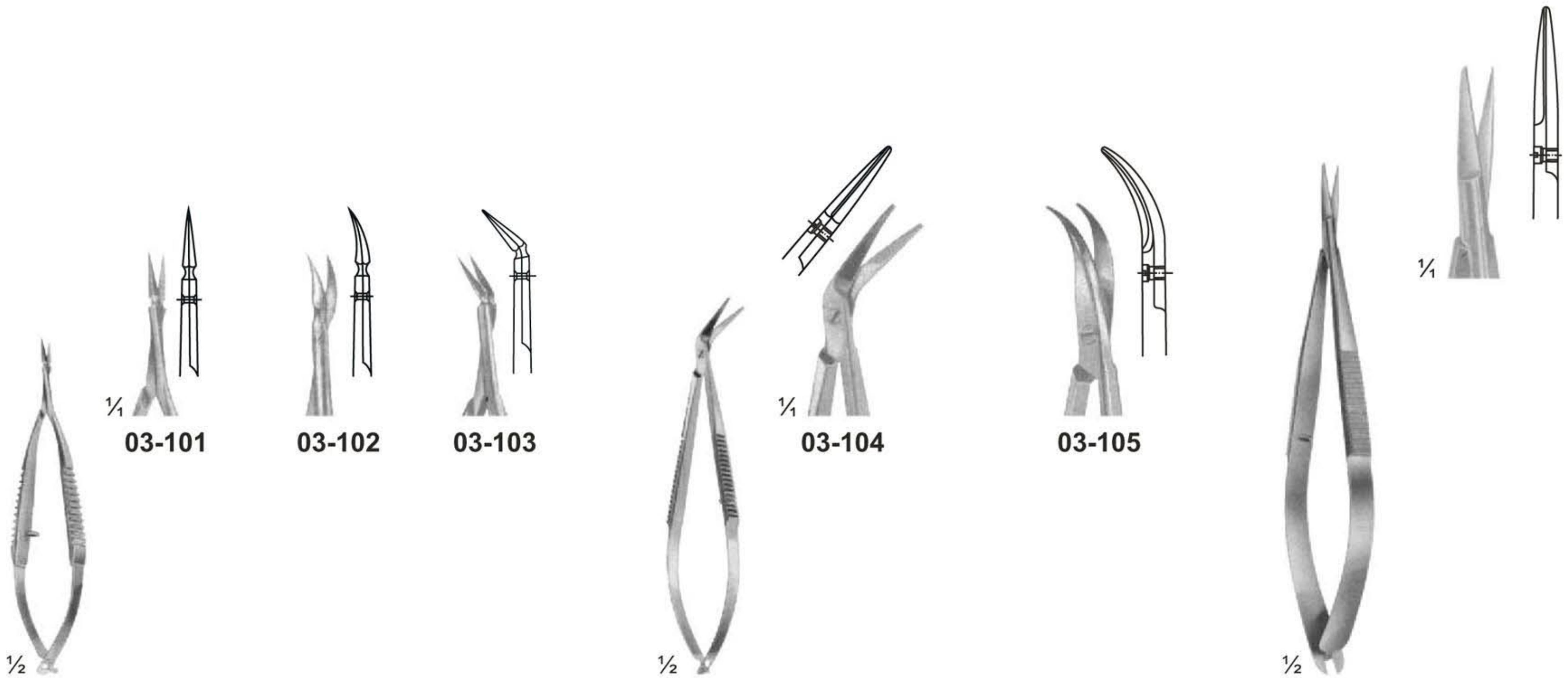

**03-101 - 103**  
VANNAS  
Size: 85 mm

**03-104 - 105**  
CASTROVIEJO  
Size: 95 mm

**03-106**  
NOYES  
Size: 125 mm

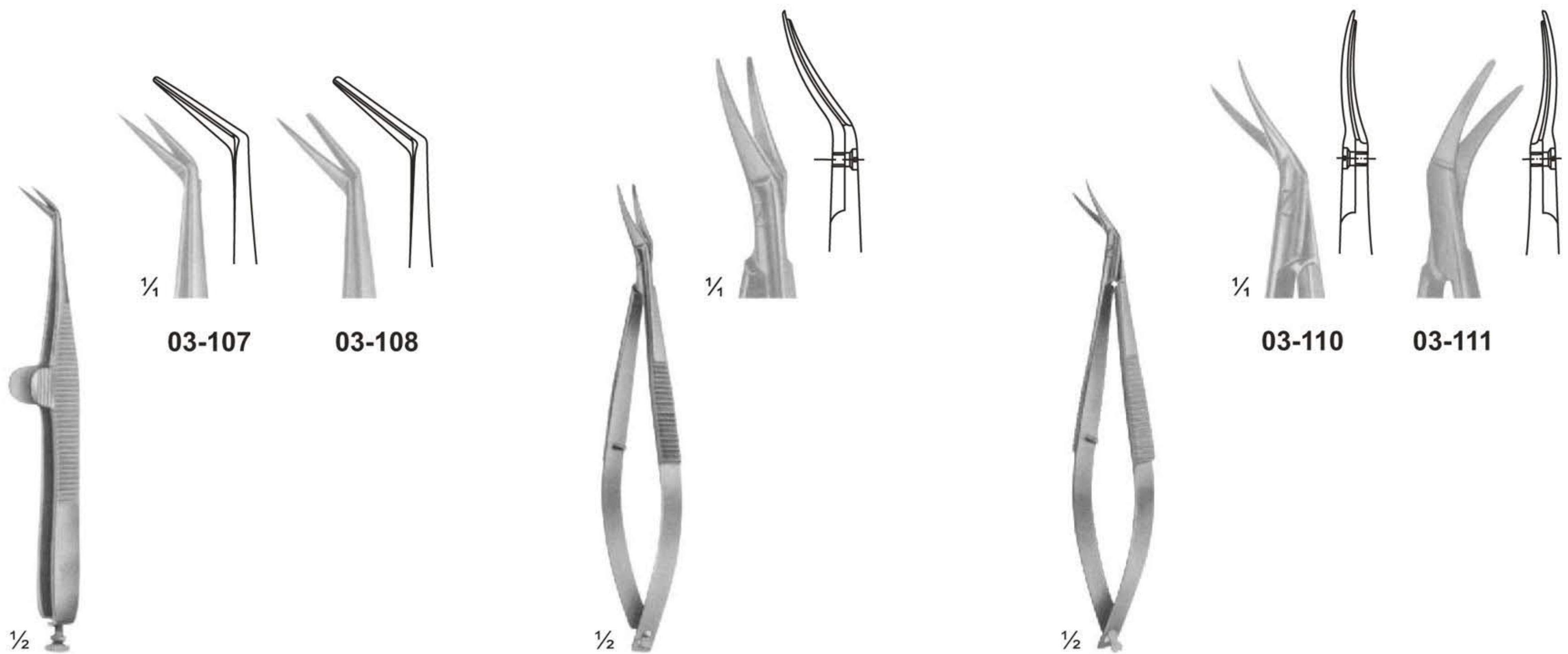

**03-107 - 108**  
WECKER  
Eye Scissor  
Size: 110 mm

**03-109**  
CASTROVIEJO  
Eye Scissor  
Size: 115 mm

**03-110 - 111**  
CASTROVIEJO  
Eye Scissor  
Size: 110 mm



# Micro Scissors, "Spring Type" Flat Handles

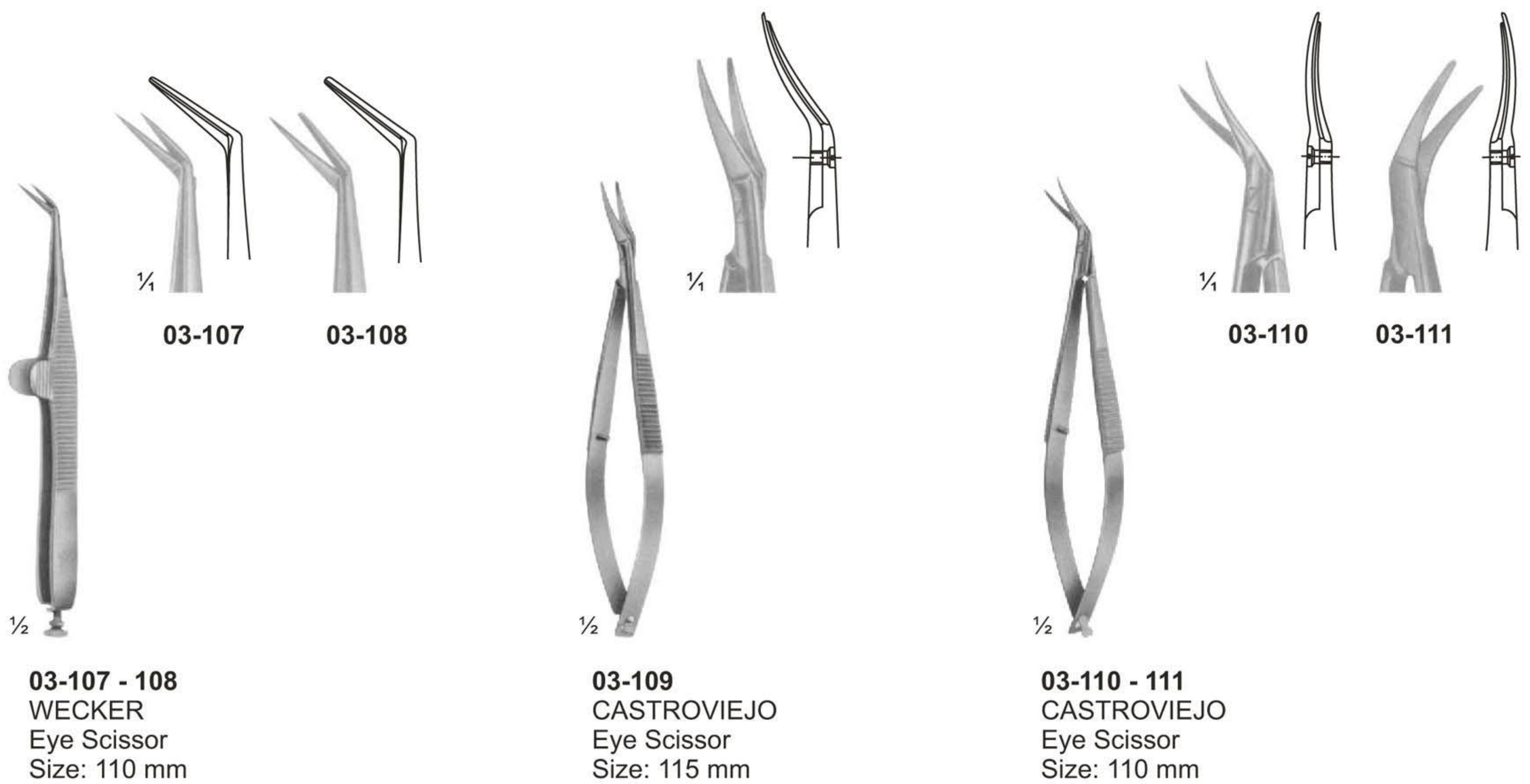
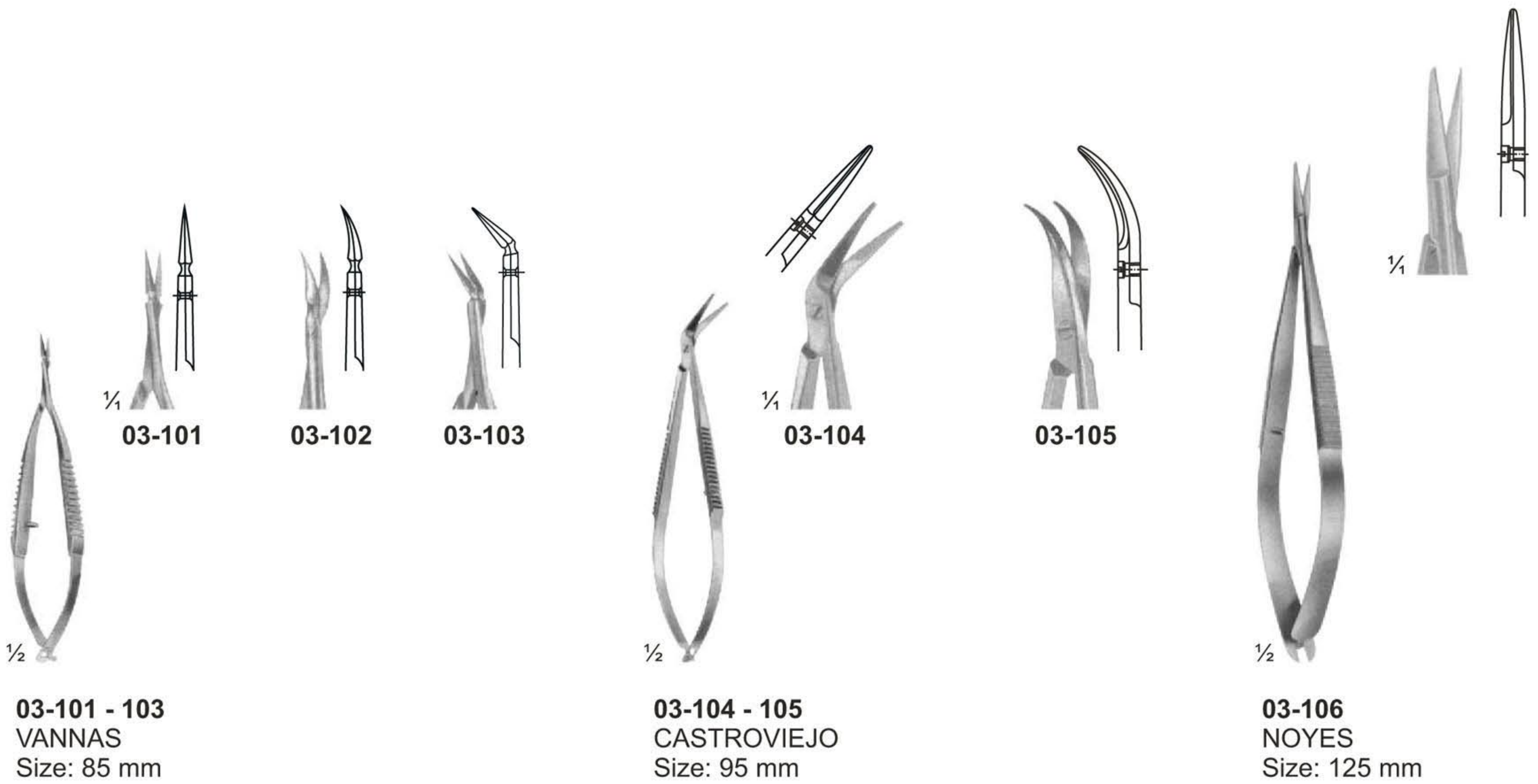



# Micro Scissors, "Spring Type" Flat Handles

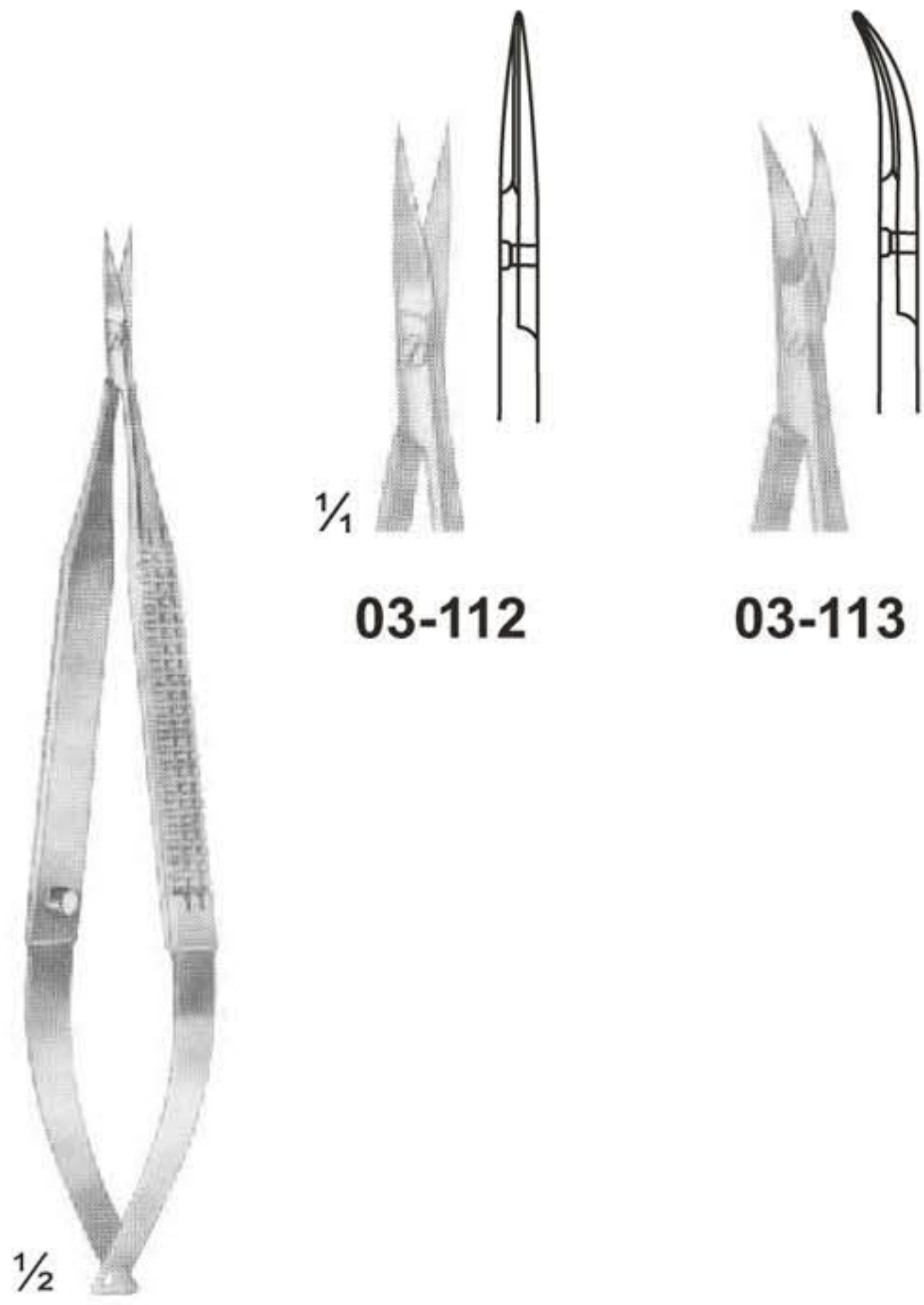

**03-112 - 113**  
Size: 120 mm

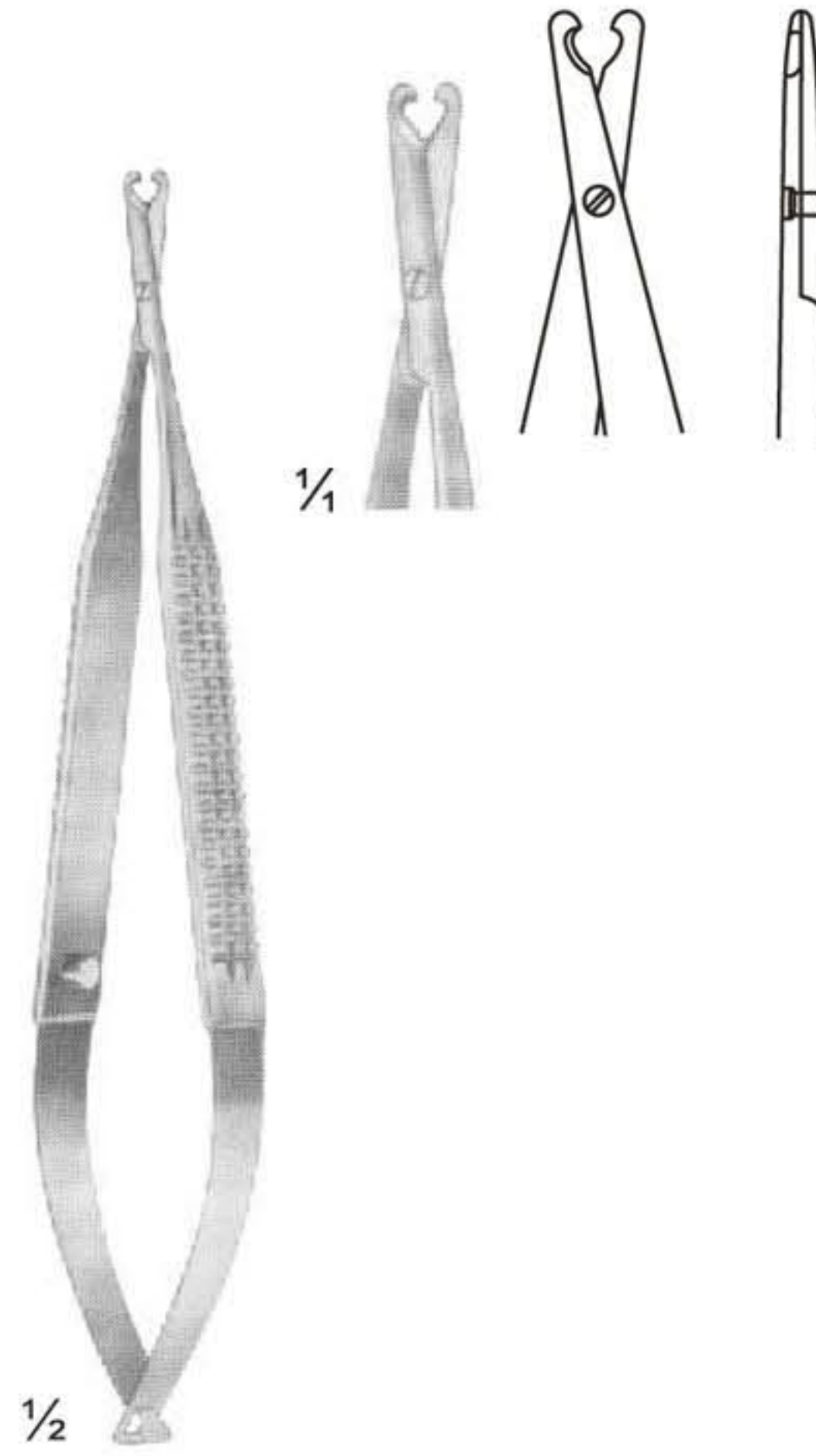

**03-114**  
BIEMER  
Vein Scissor  
Size: 130 mm

**03-115**  
Size: 160 mm

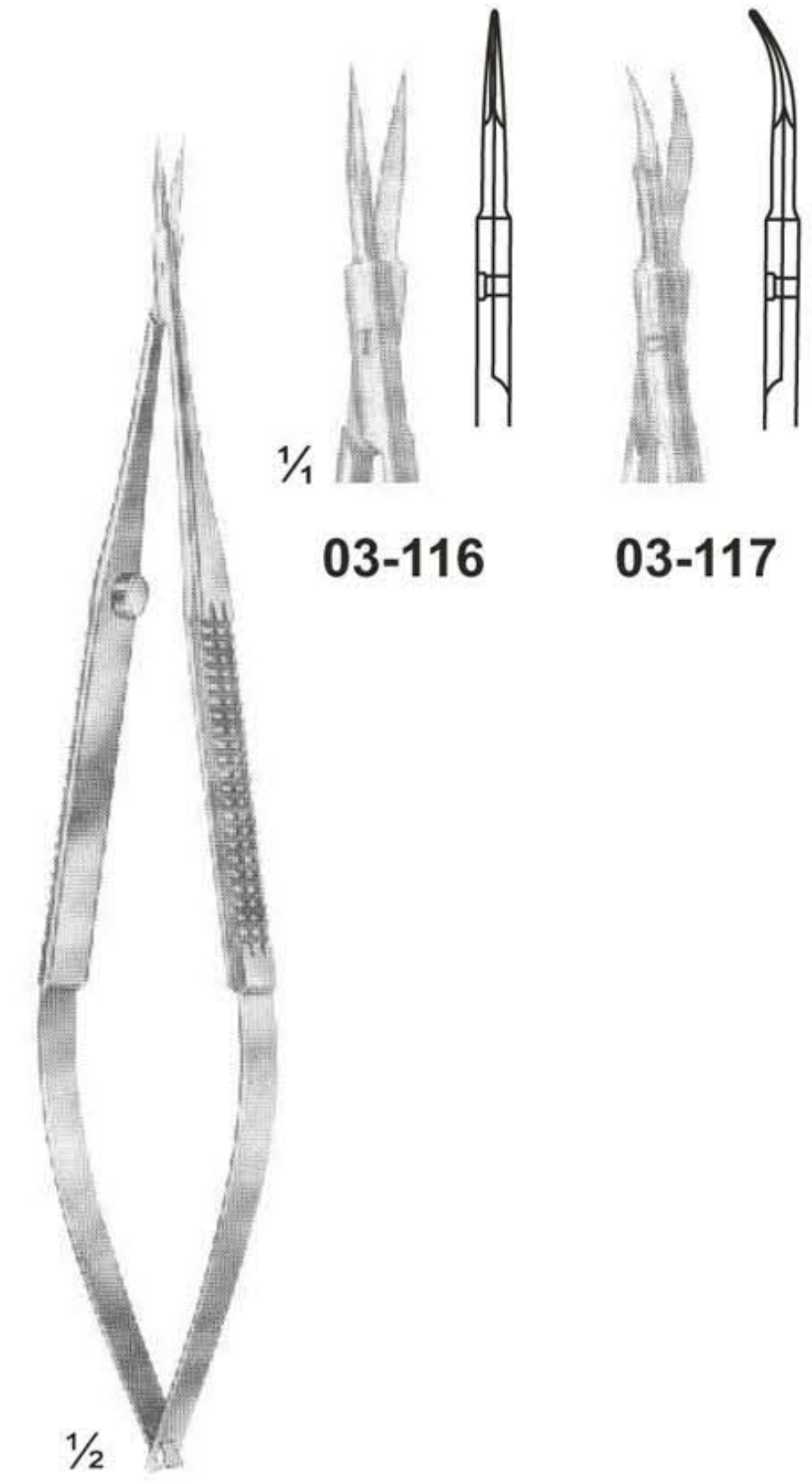

**03-116 - 117**  
VANNAS  
Size: 160 mm

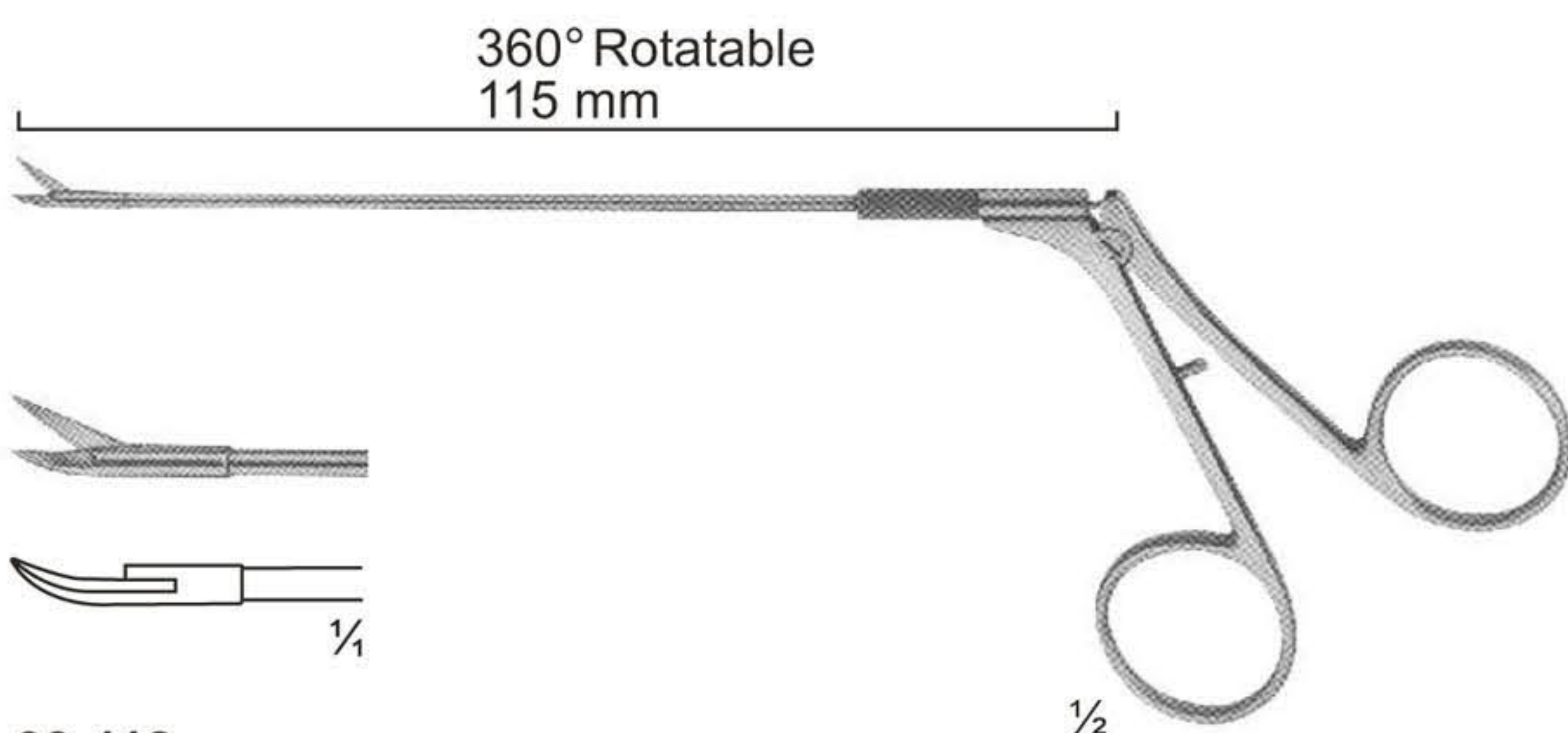

**03-118**  
CASPAR  
Micro Scissor Curved  
Size: 115 mm

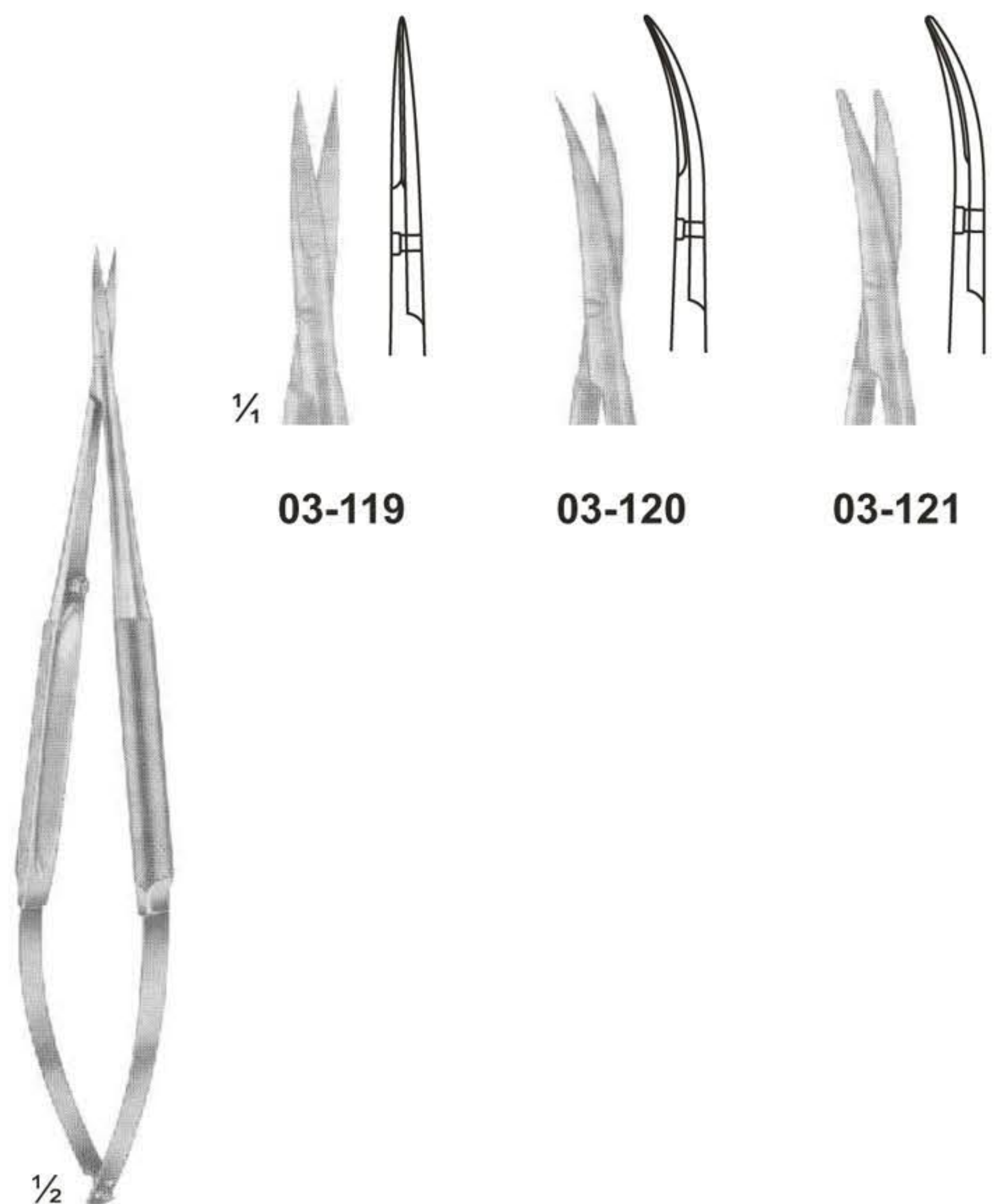

**03-119 - 121**  
Micro Dissecting Scissor  
Size: 145 mm



**Micro Scissors, "Spring Type" Bayonet Shape**

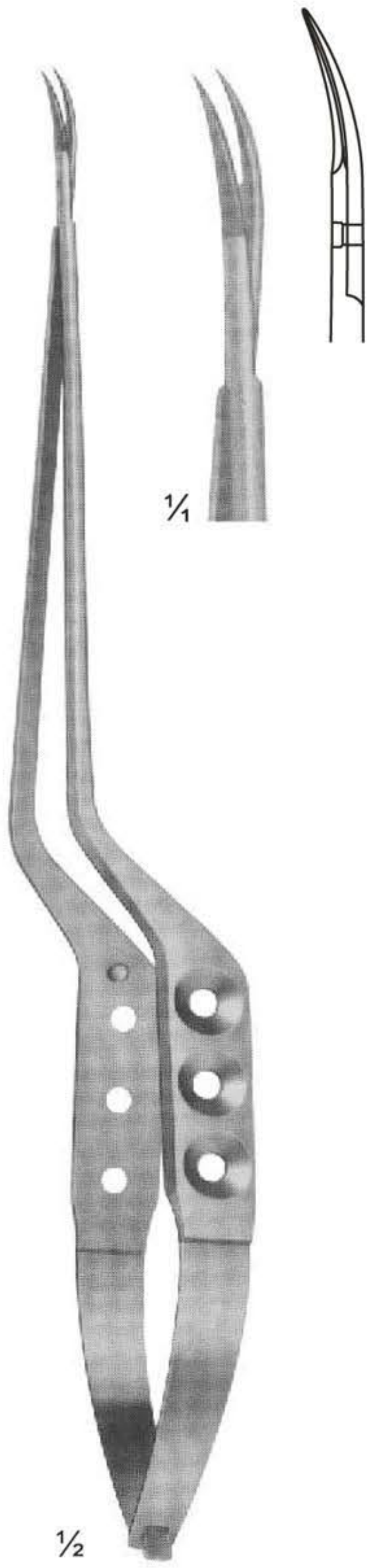

**03-122**  
YASARGIL  
Size: 245 mm

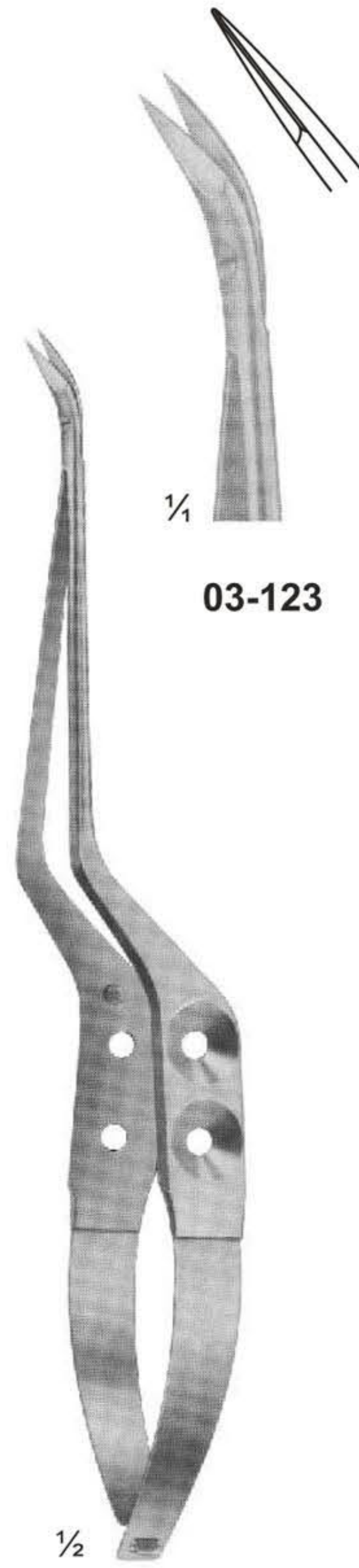

**03-123**



**03-124**

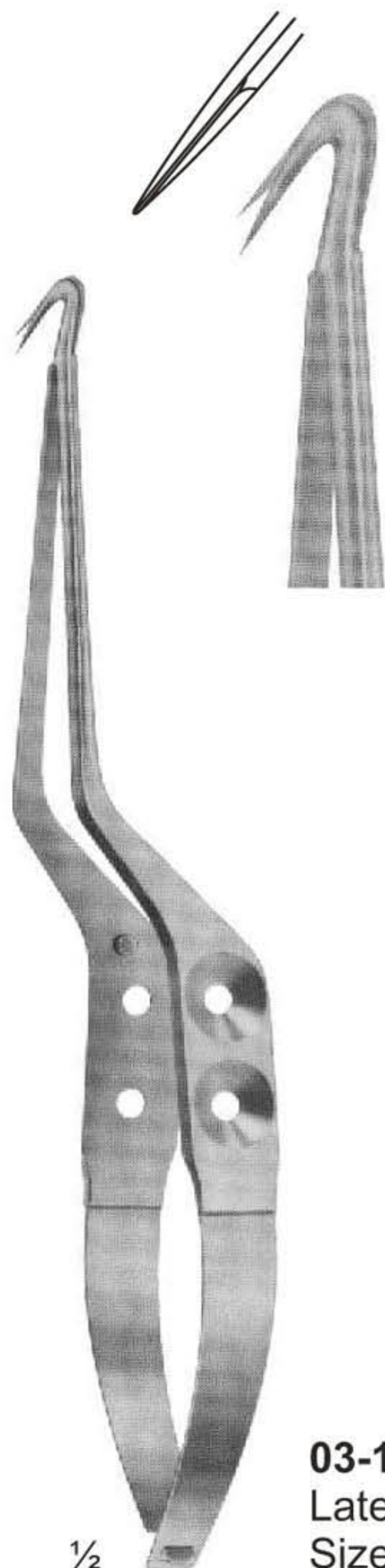

**03-125**  
Laterally Angled  
Size: 190 mm

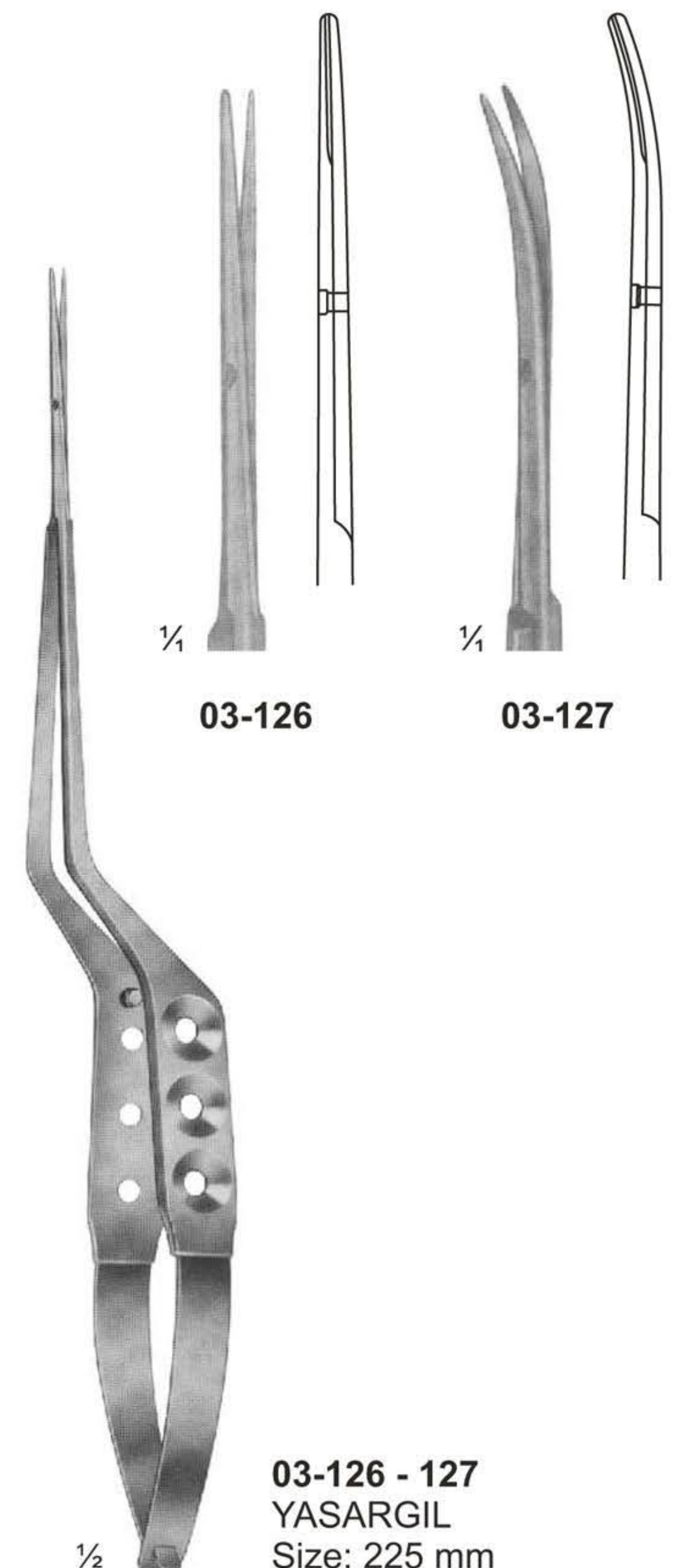

**03-126**

**03-127**

**03-126 - 127**  
YASARGIL  
Size: 225 mm



**Delicate Scissors**

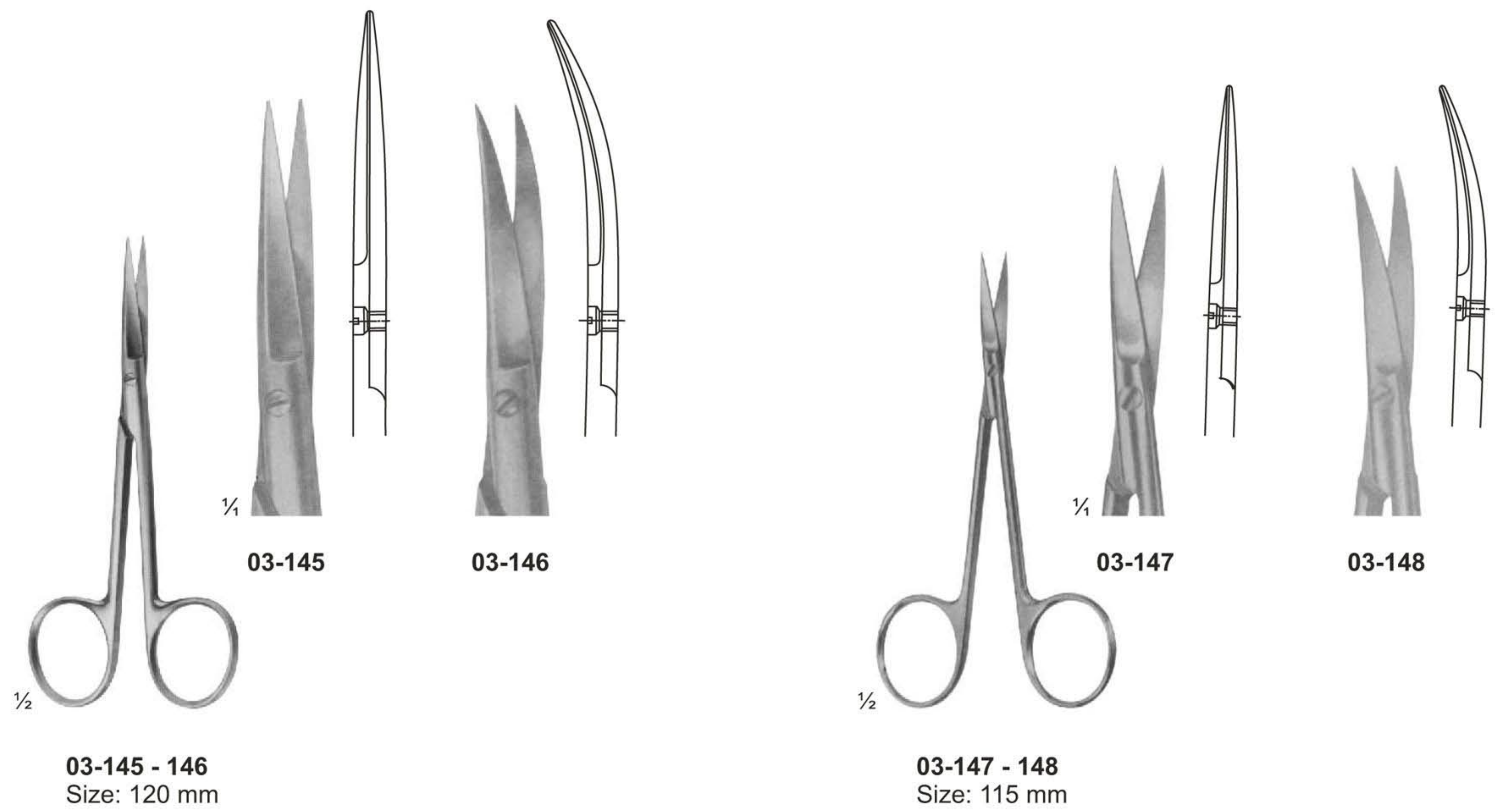
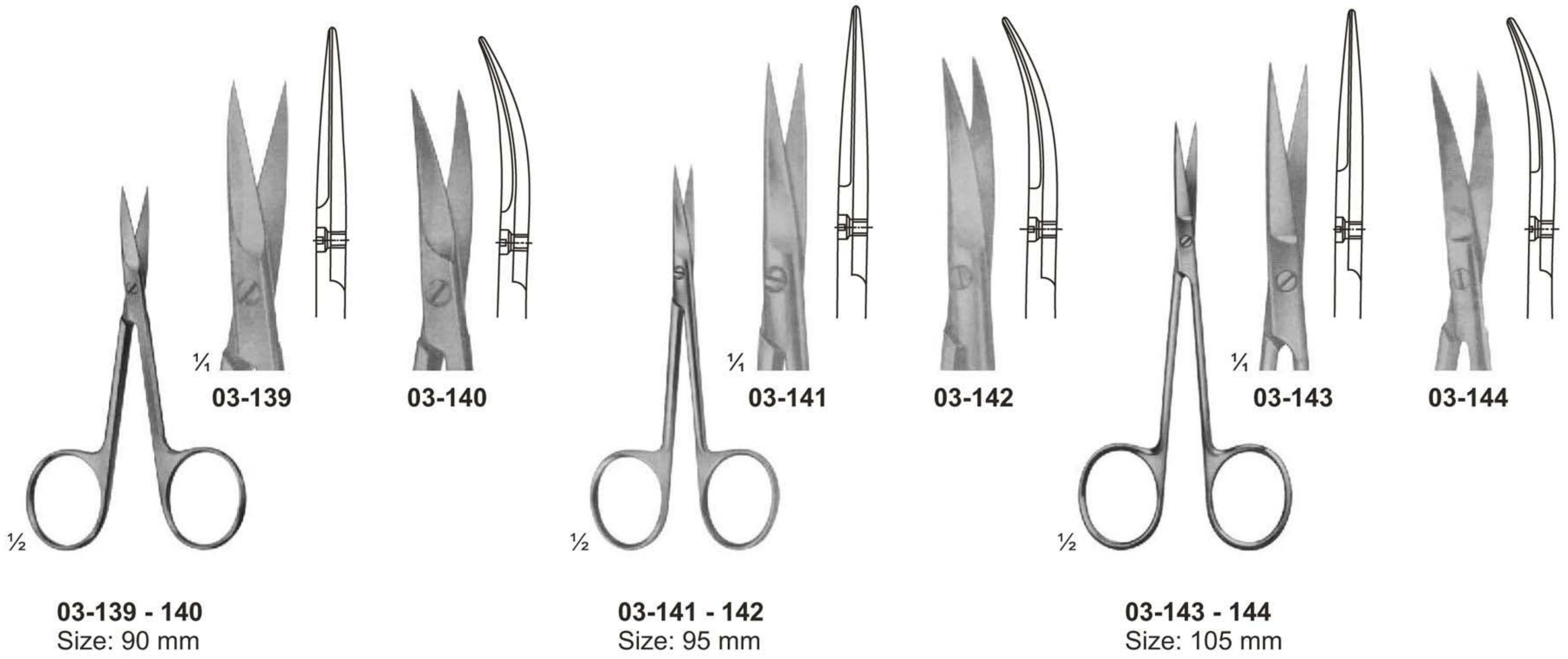



**Delicate Scissors**

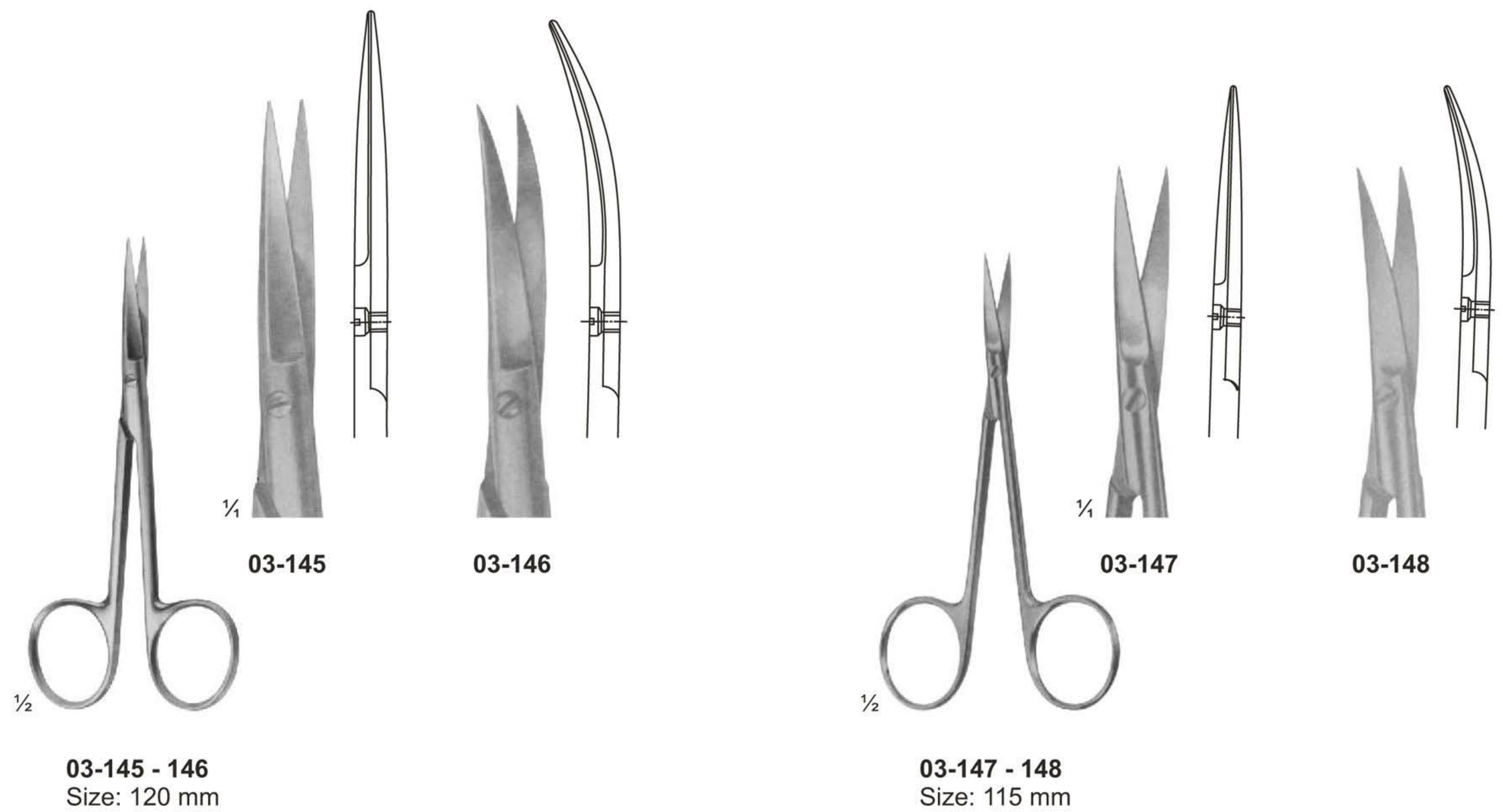
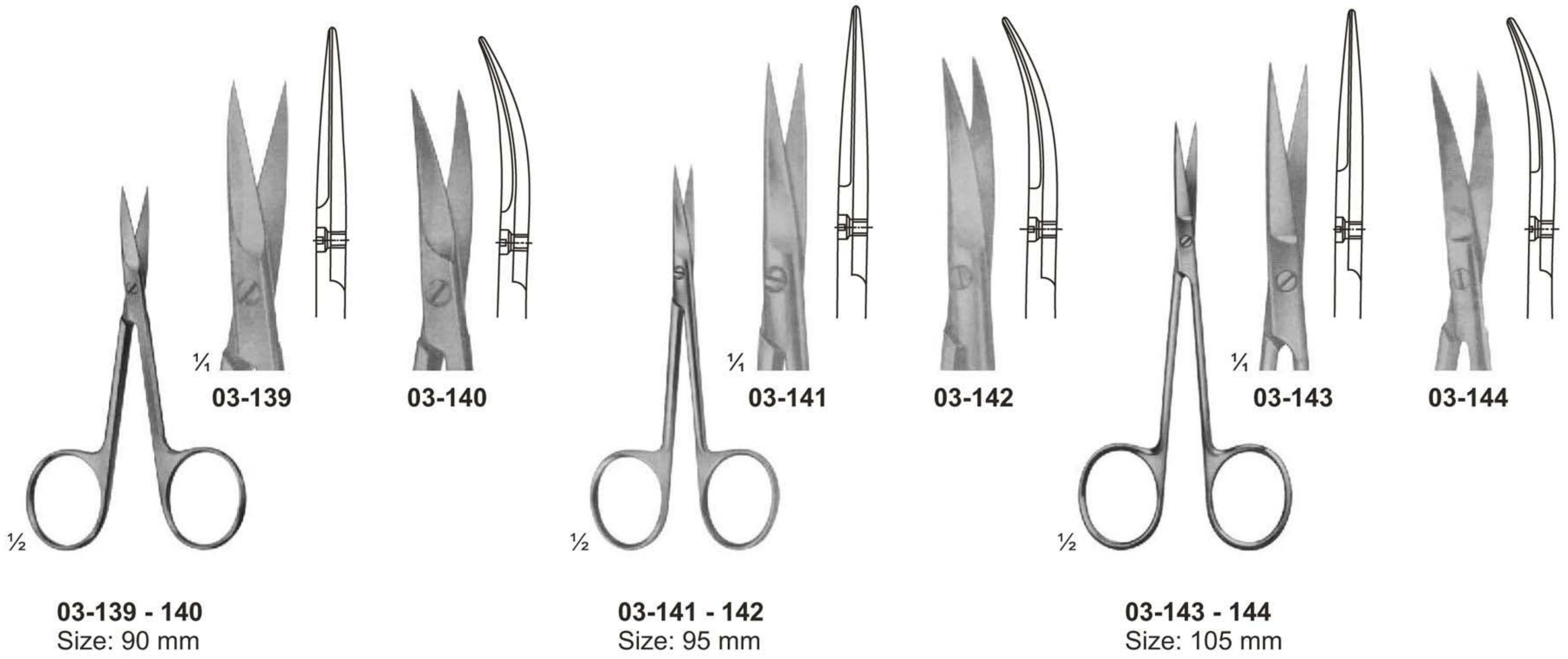



**Delicate Scissors**



**03-149 - 151**  
Size: 120 mm

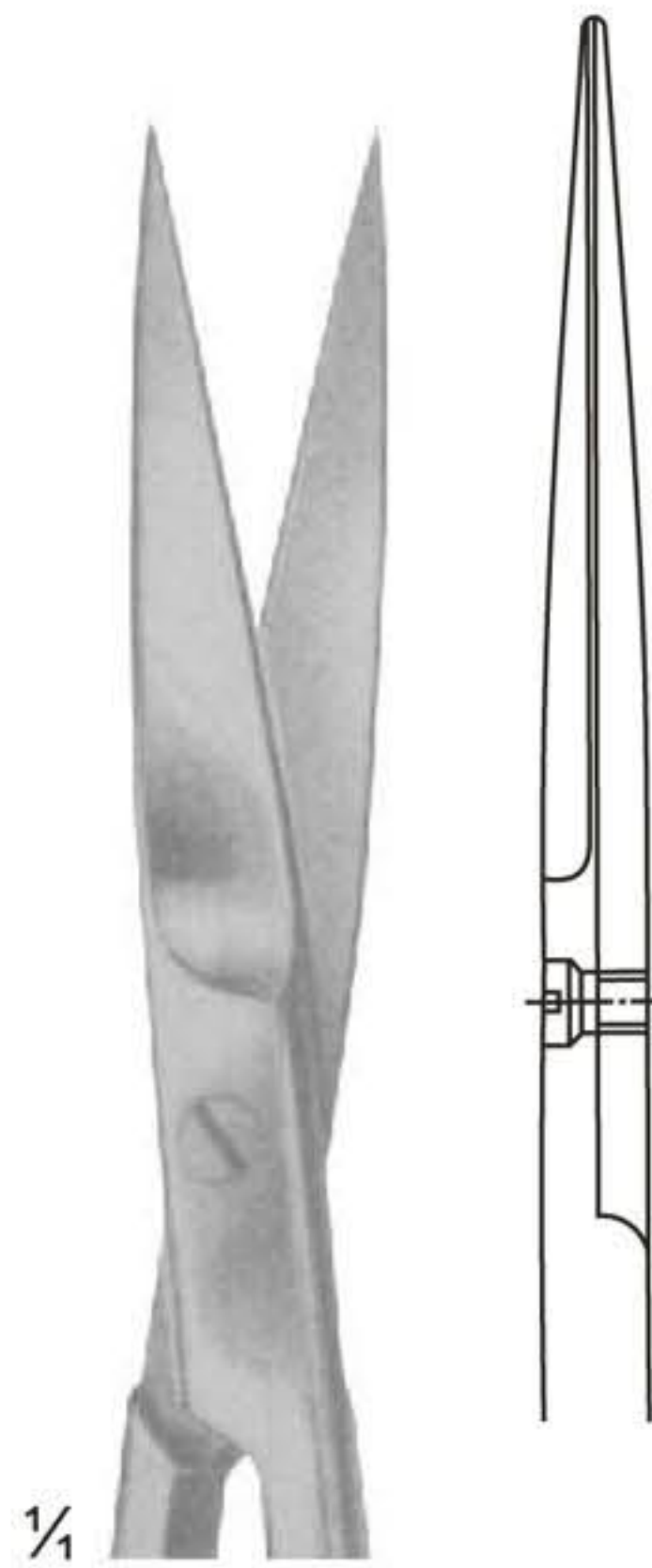

**03-149**

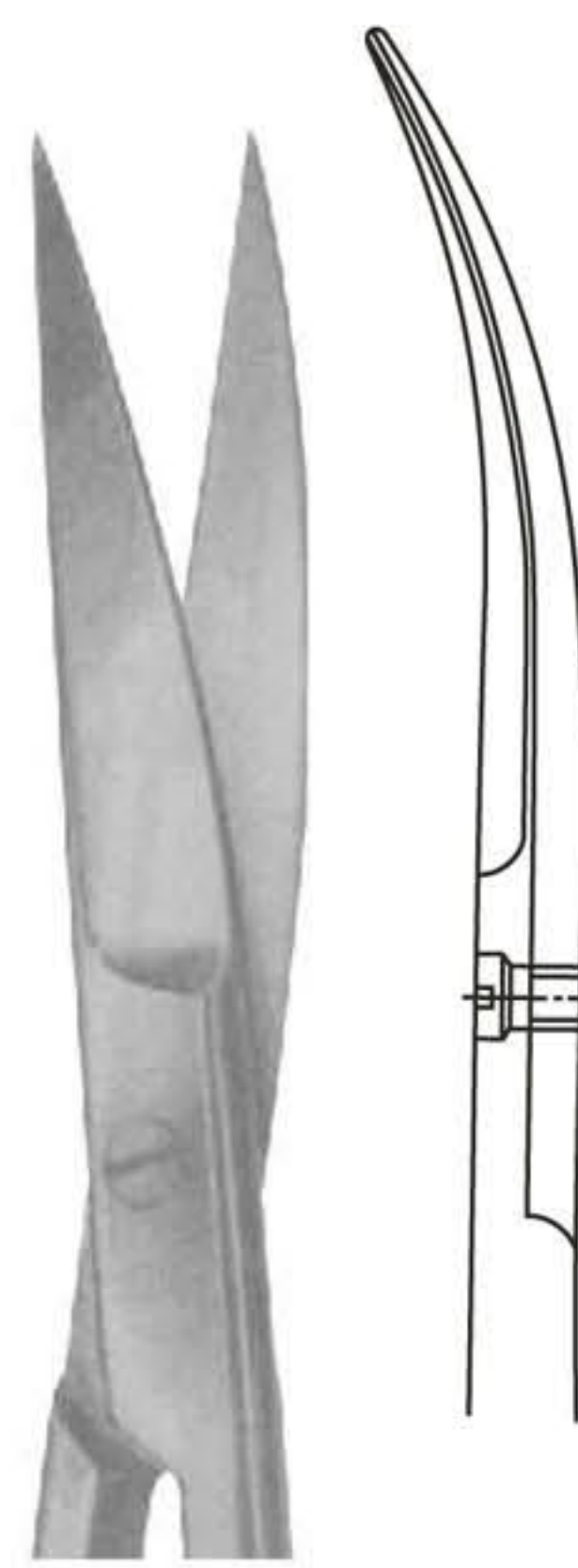

**03-150**

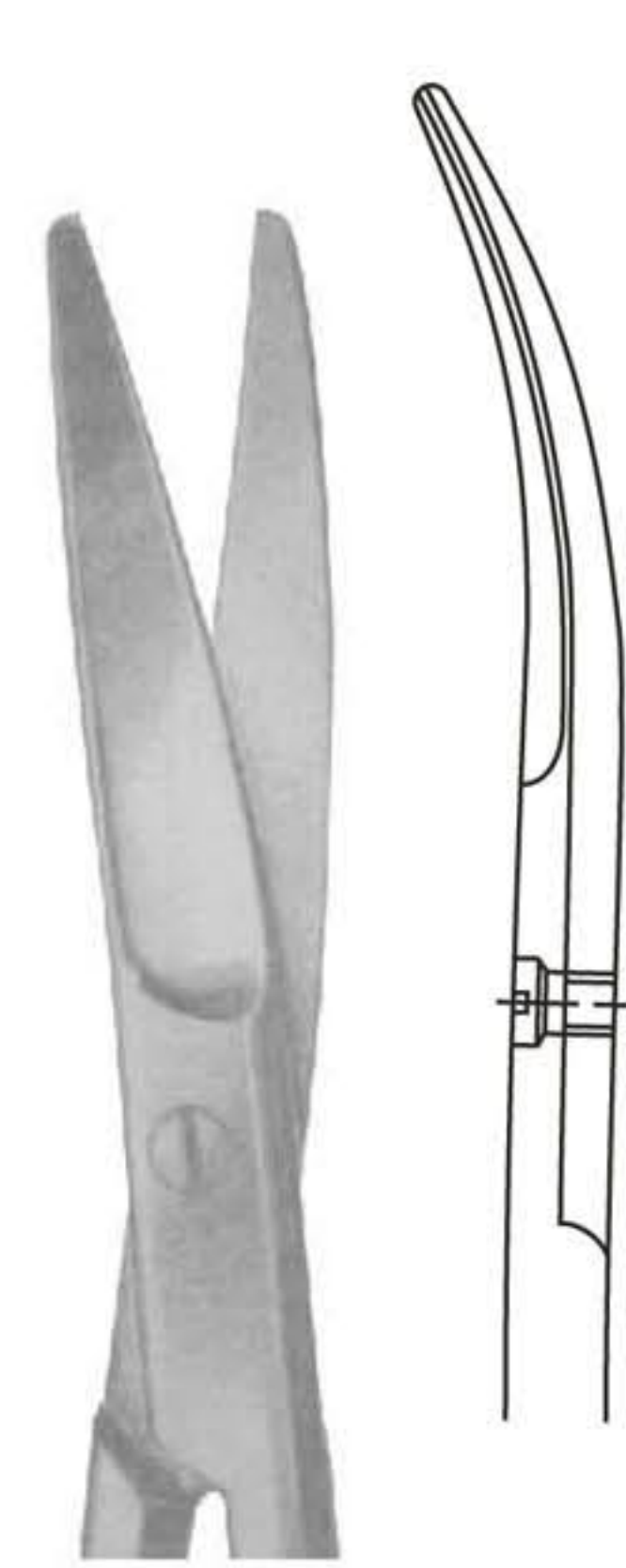

**03-151**



**03-152 - 155**  
Size: 130 mm

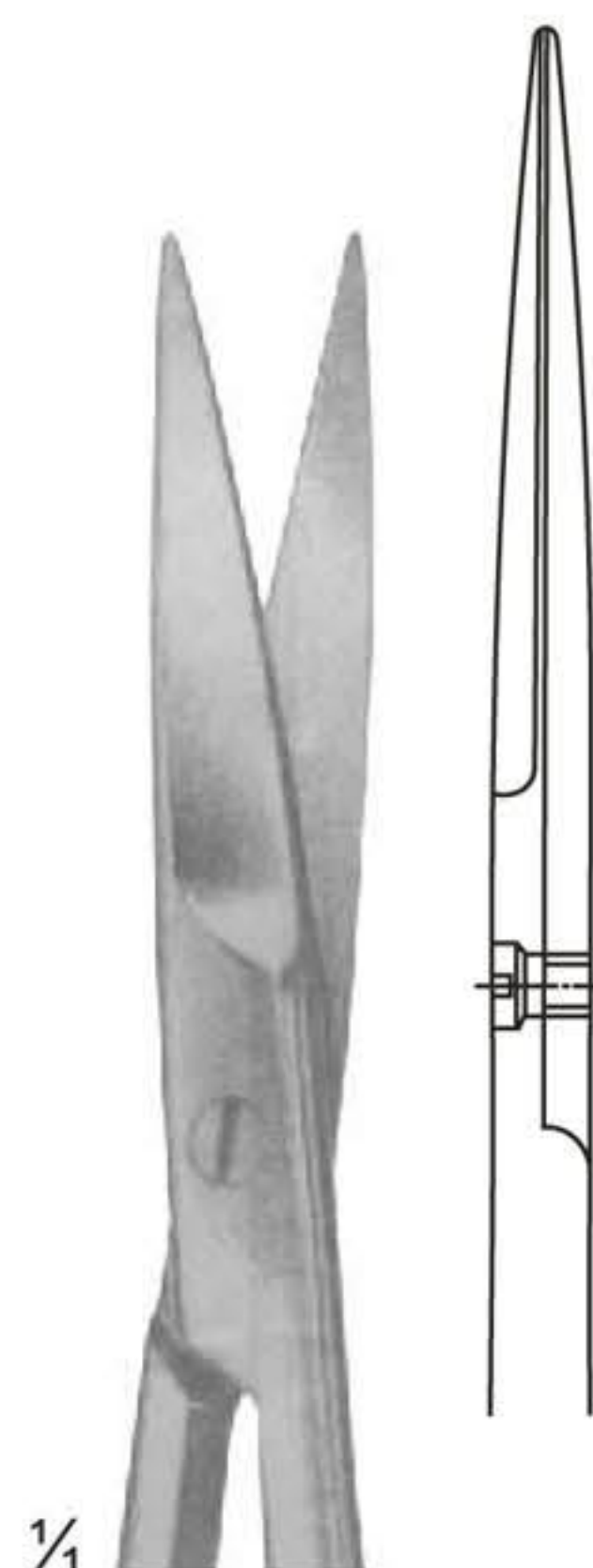

**03-152**

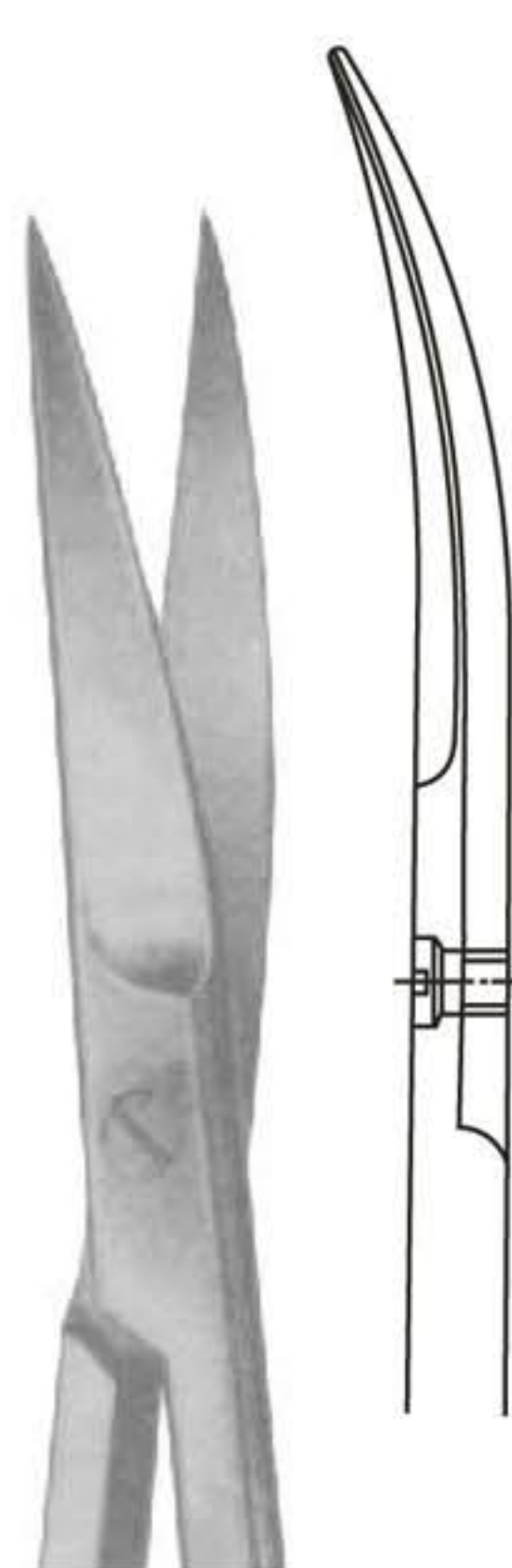

**03-153**

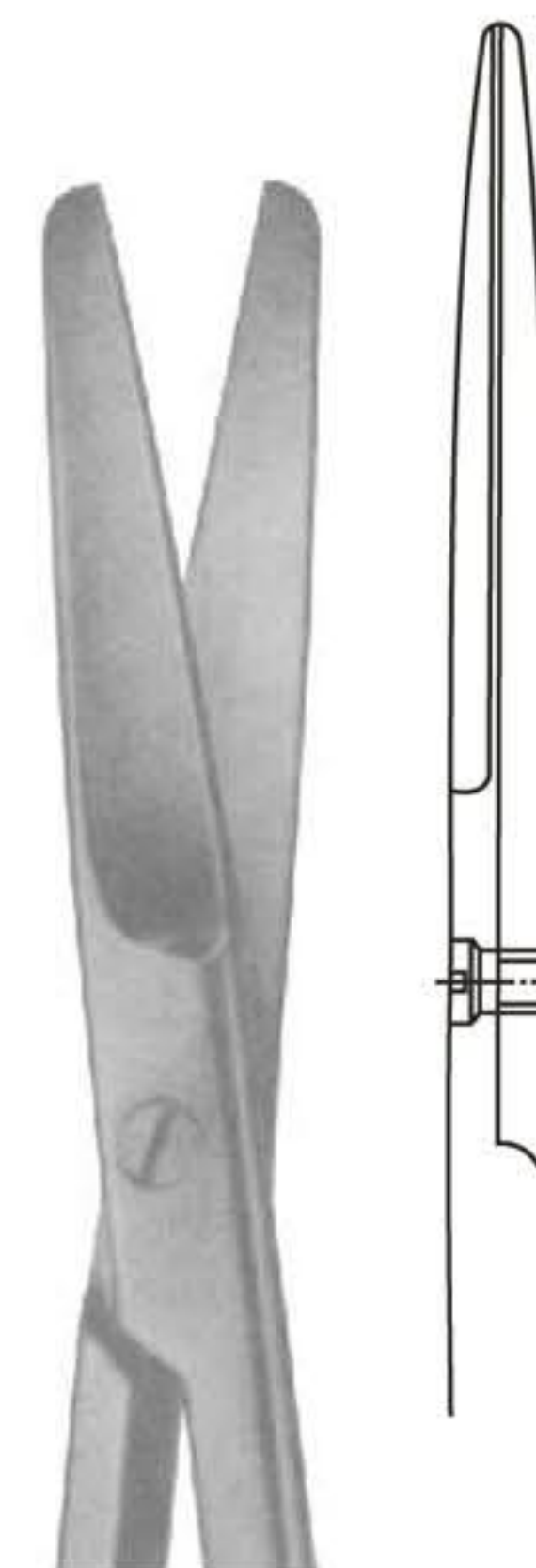

**03-154**

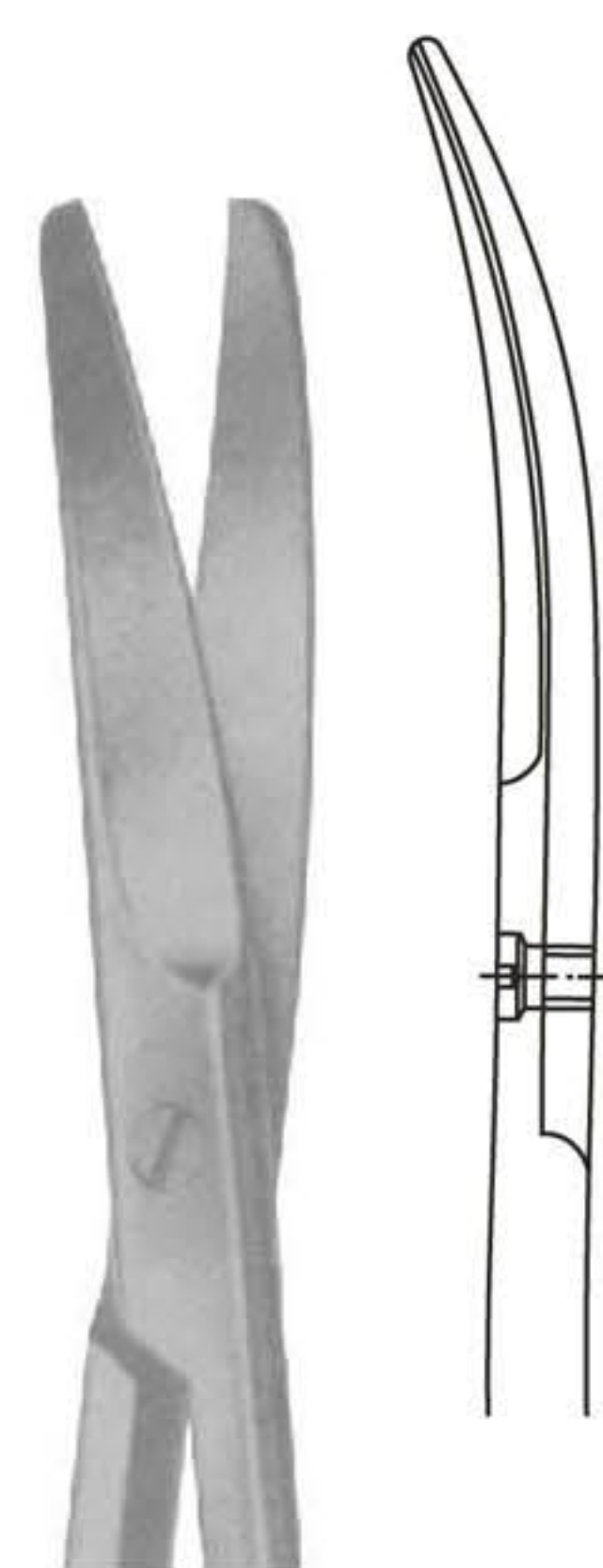

**03-155**



**Delicate Scissors**

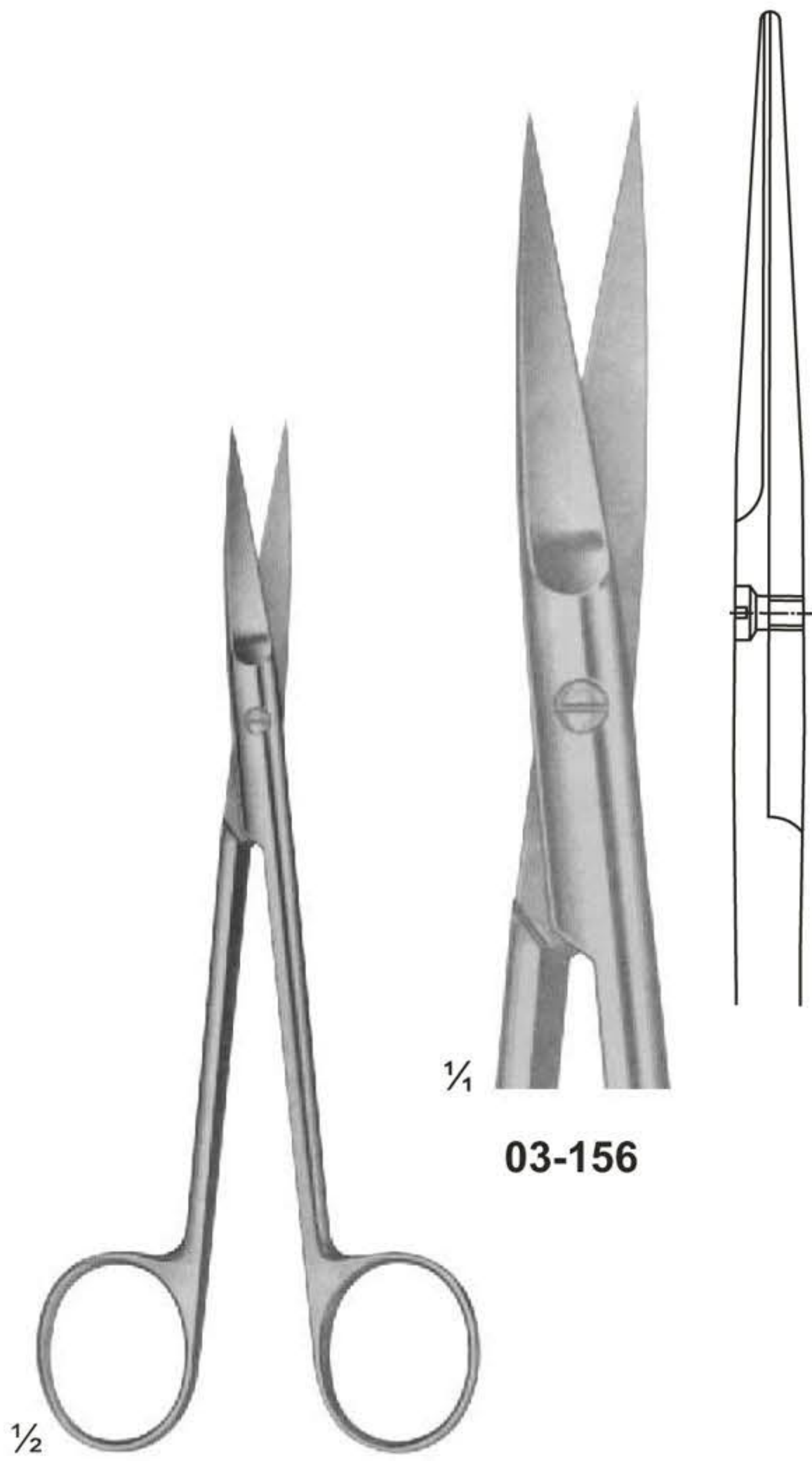

**03-156**

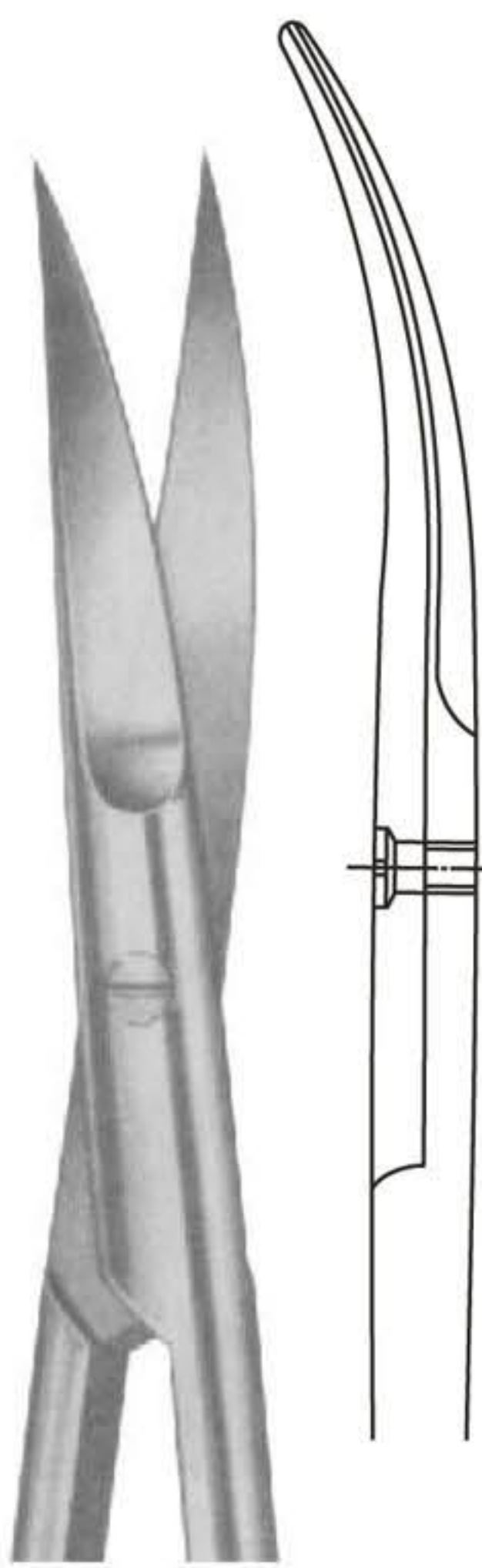

**03-157**

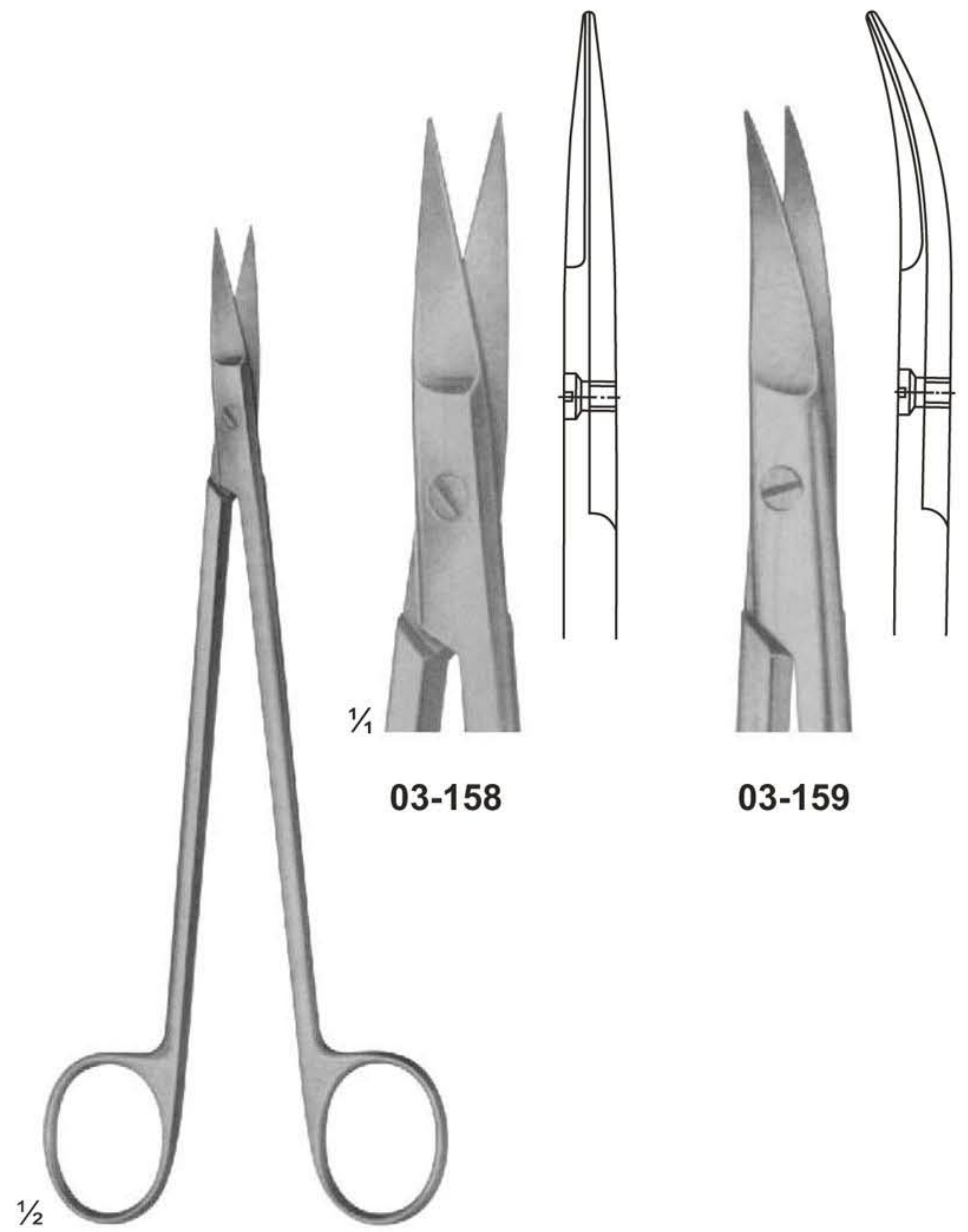

**03-158**

**03-159**

**03-156 - 157**  
JOSEPH  
Size: 150 mm

**03-158 - 159**  
KELLY  
Size: 175 mm

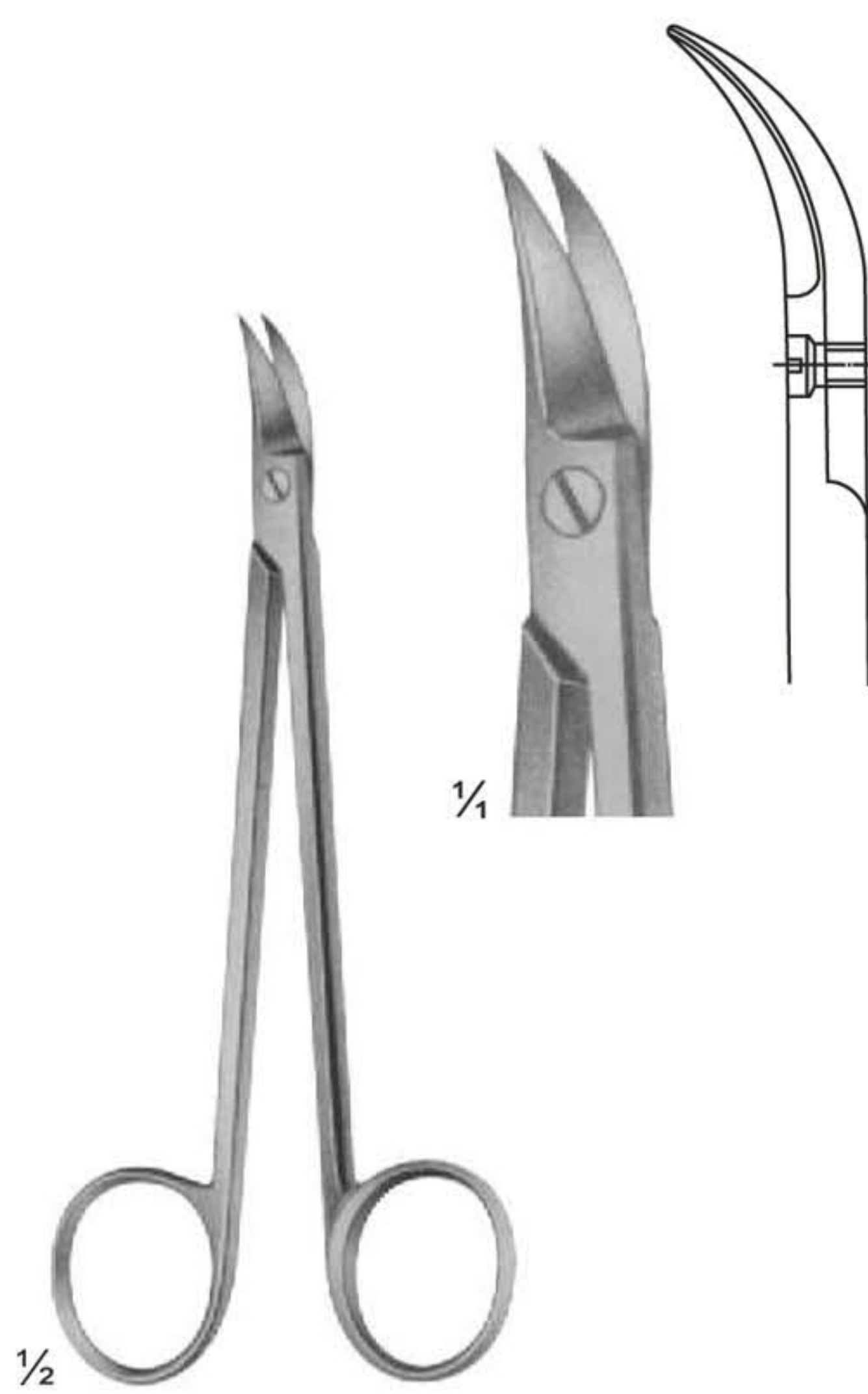

**03-160**  
QUINBY  
Size: 130 mm

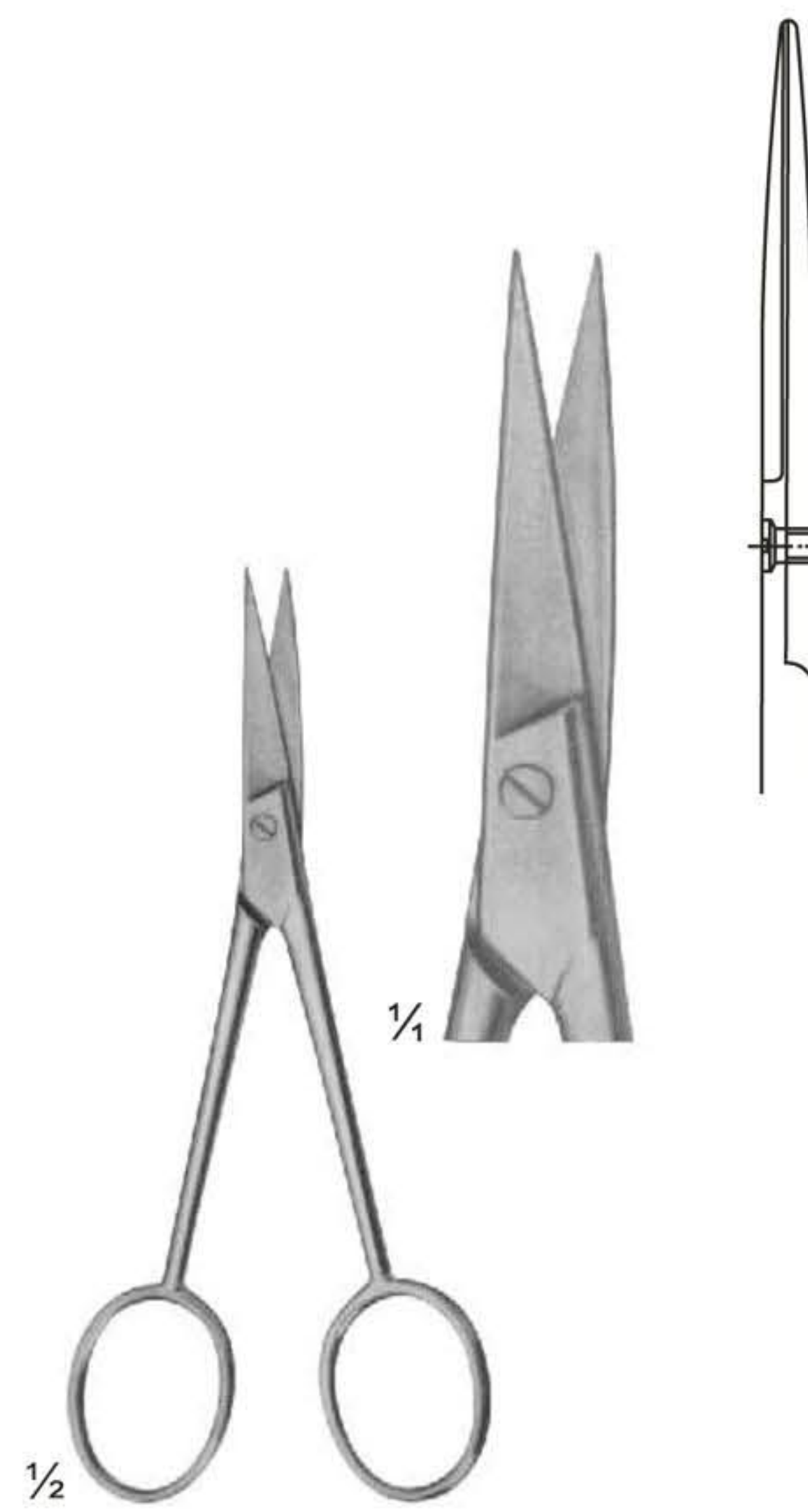

**03-161**  
Size: 110 mm



# Surgical Scissors

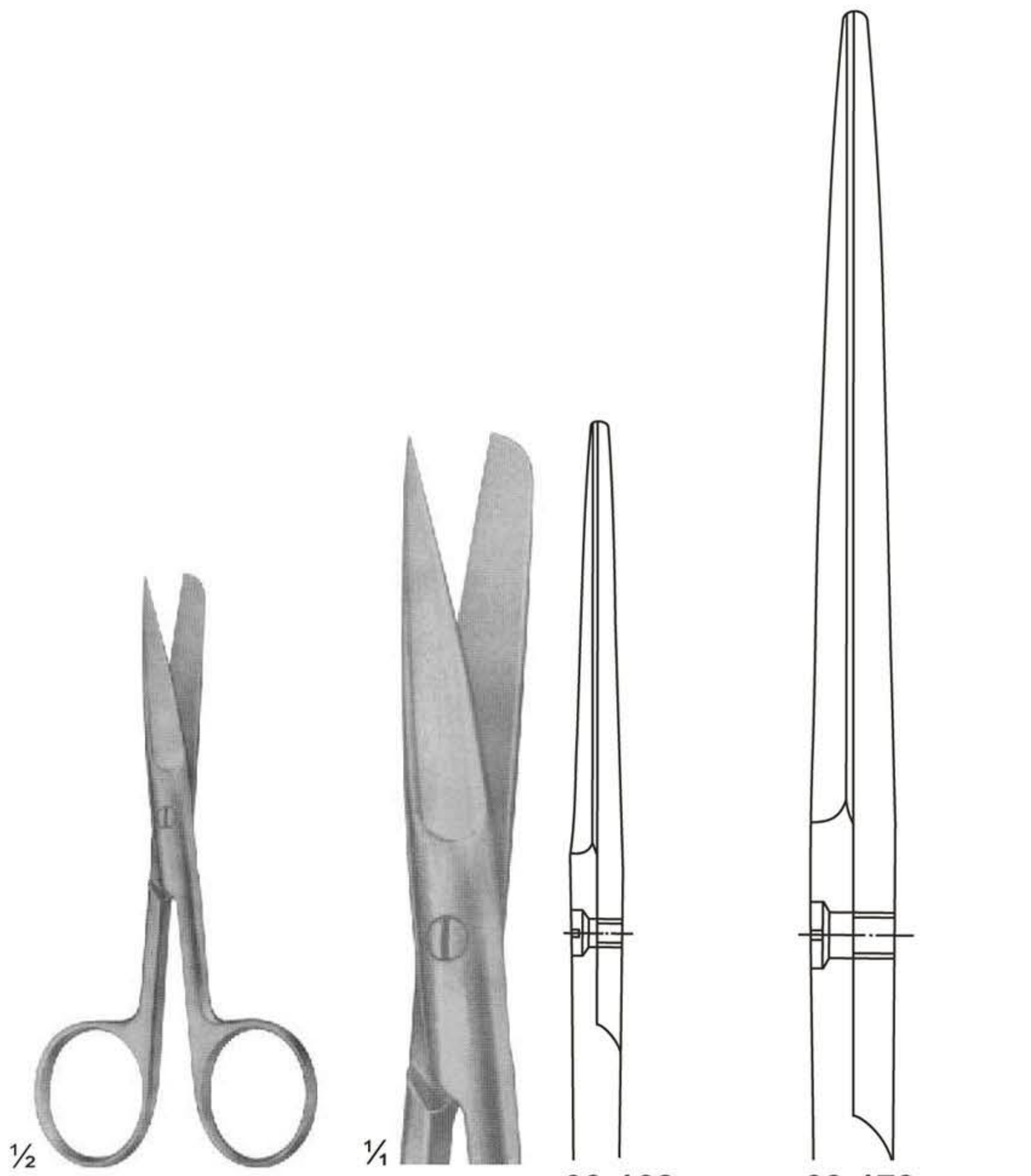

**03-162 - 170 (Standard Types)**  
**03-162** ( 105 mm )  
**03-163** ( 115 mm )  
**03-164** ( 130 mm )  
**03-165** ( 145 mm )  
**03-166** ( 150 mm )  
**03-167** ( 165 mm )  
**03-168** ( 175 mm )  
**03-169** ( 185 mm )  
**03-170** ( 200 mm )



**03-171 - 177 (Standard Types)**  
**03-171** ( 115 mm )  
**03-172** ( 130 mm )  
**03-173** ( 145 mm )  
**03-174** ( 150 mm )  
**03-175** ( 165 mm )  
**03-176** ( 175 mm )  
**03-177** ( 185 mm )

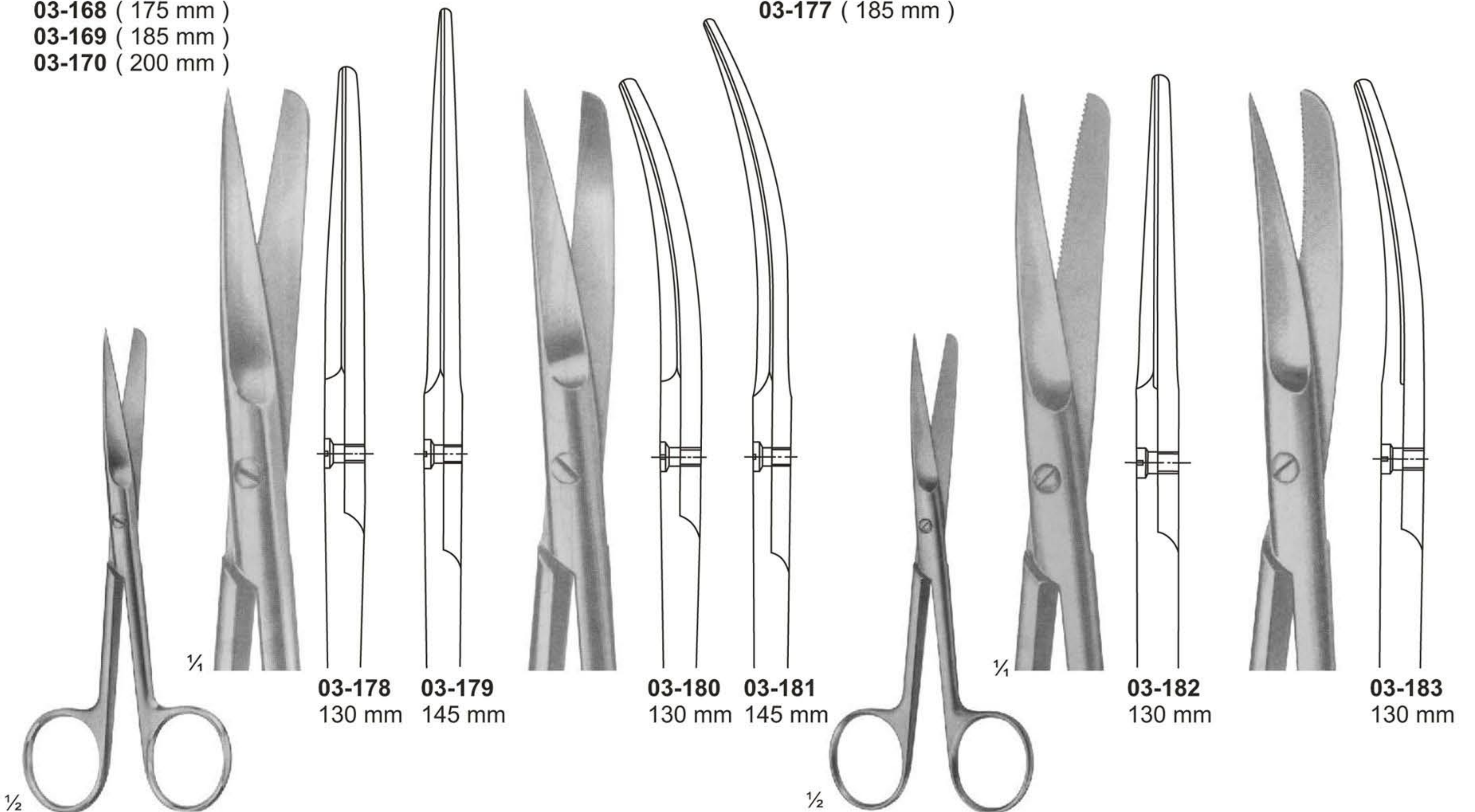

**03-178 - 181**  
Slender Types

**03-182 - 183**  
For Wound Edges  
1 Blade Serrated



# Surgical Scissors

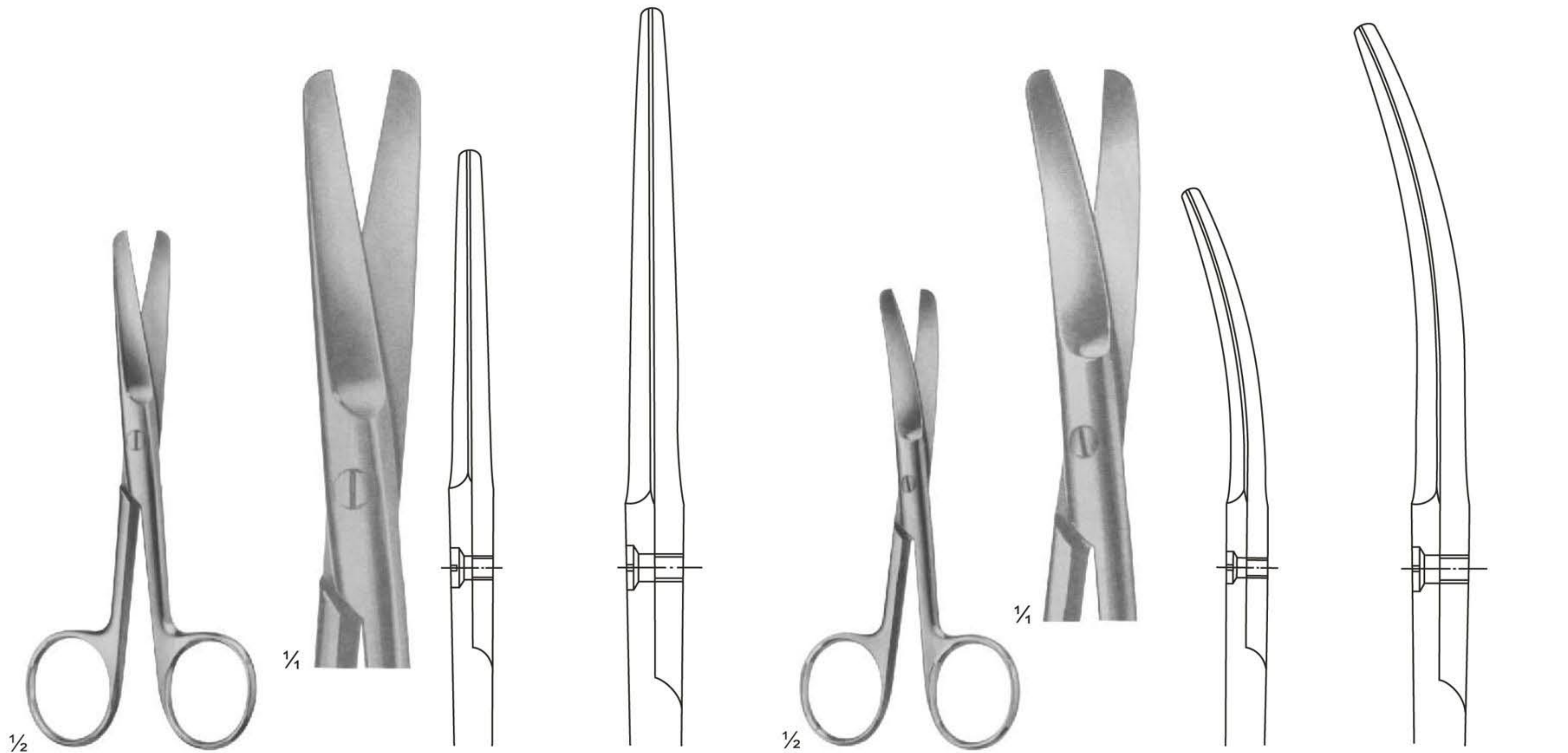

**03-184 - 188** (Standard Types)  
**03-184** ( 130 mm )  
**03-185** ( 145 mm )  
**03-186** ( 150 mm )  
**03-187** ( 165 mm )  
**03-188** ( 175 mm )

**03-184**      **03-188**  
 Size: 130 mm    Size: 175 mm

**03-189 - 194 - COOPER**  
 Standard Types  
**03-189** ( 115 mm )  
**03-190** ( 130 mm )  
**03-191** ( 145 mm )  
**03-192** ( 150 mm )  
**03-193** ( 165 mm )  
**03-194** ( 175 mm )

**03-189**      **03-194**  
 Size: 115 mm    Size: 175 mm

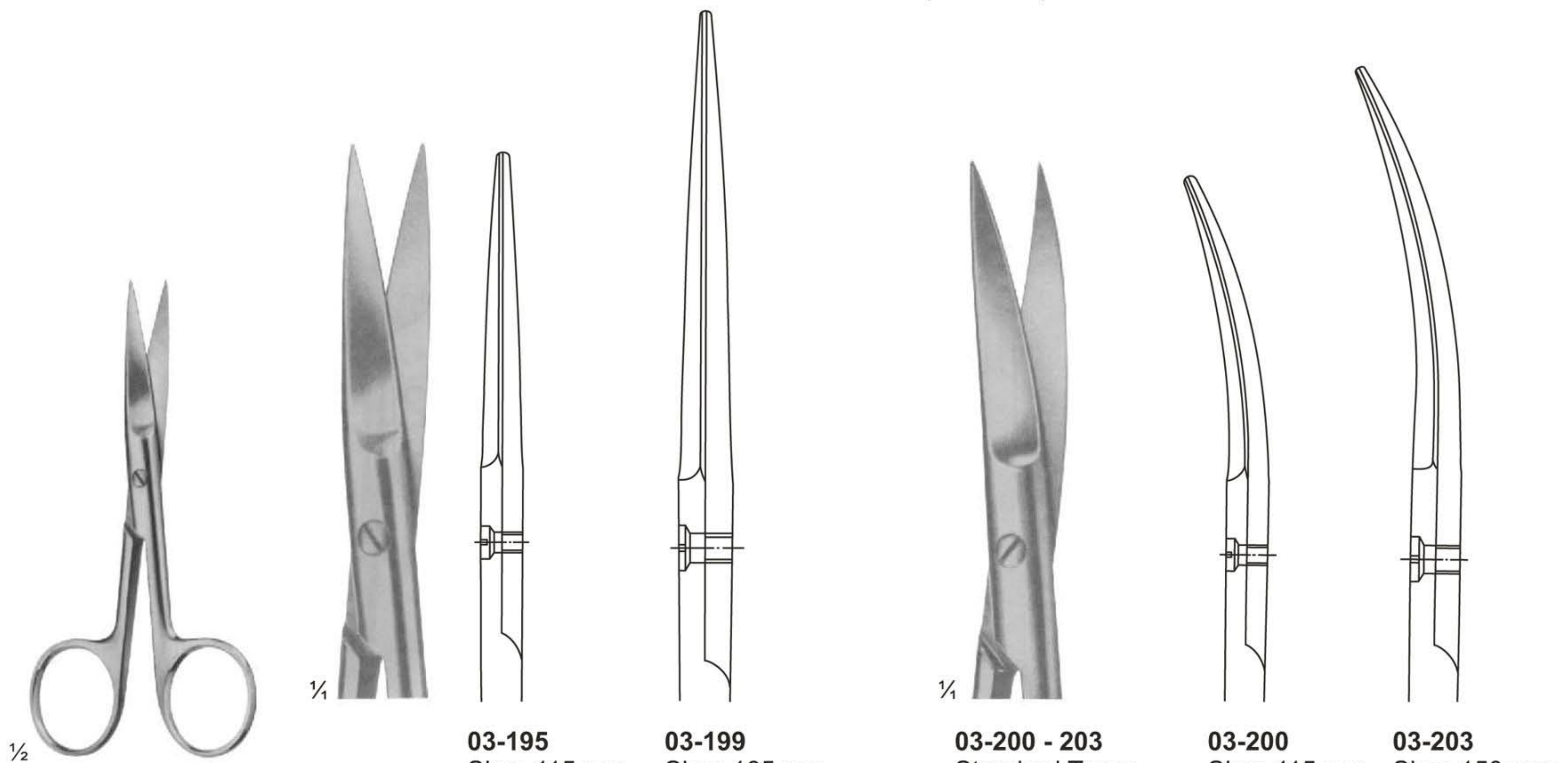

**03-195 - 199**  
 Standard Types  
**03-195** ( 115 mm )  
**03-196** ( 130 mm )  
**03-197** ( 145 mm )  
**03-198** ( 150 mm )  
**03-199** ( 165 mm )

**03-195**      **03-199**  
 Size: 115 mm    Size: 165 mm

**03-200 - 203**  
 Standard Types  
**03-200** ( 115 mm )  
**03-201** ( 130 mm )  
**03-202** ( 145 mm )  
**03-203** ( 150 mm )

**03-200**      **03-203**  
 Size: 115 mm    Size: 150 mm



**Surgical Scissors**

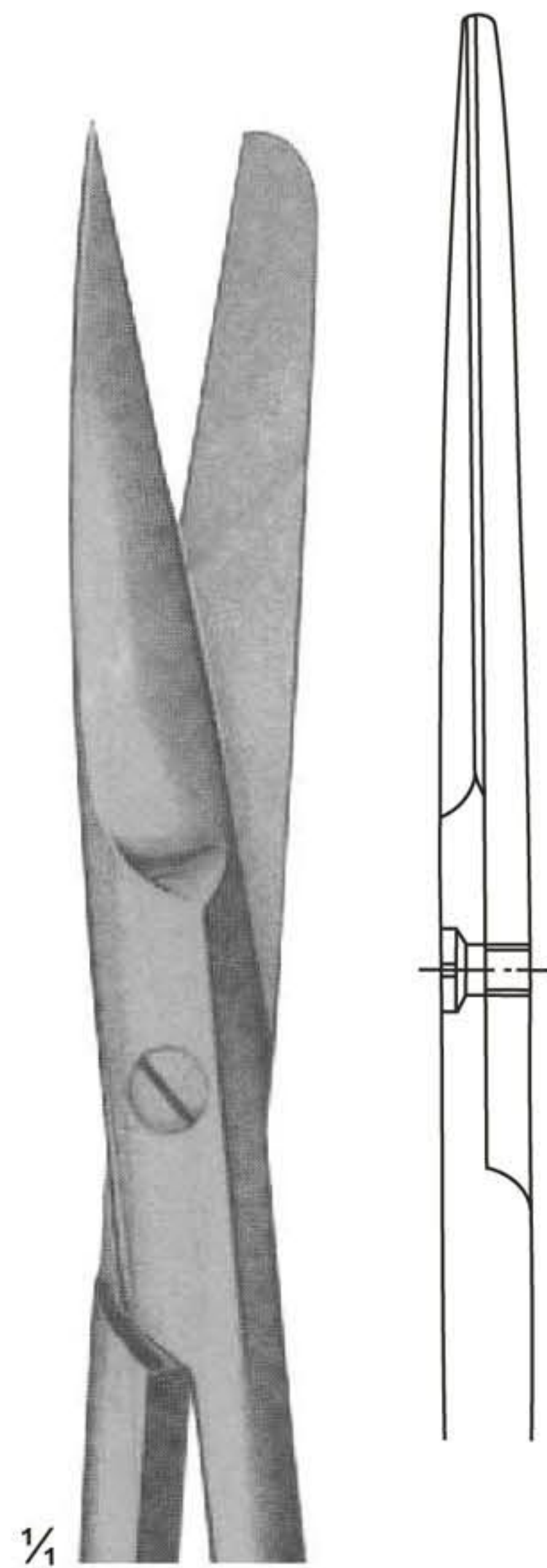
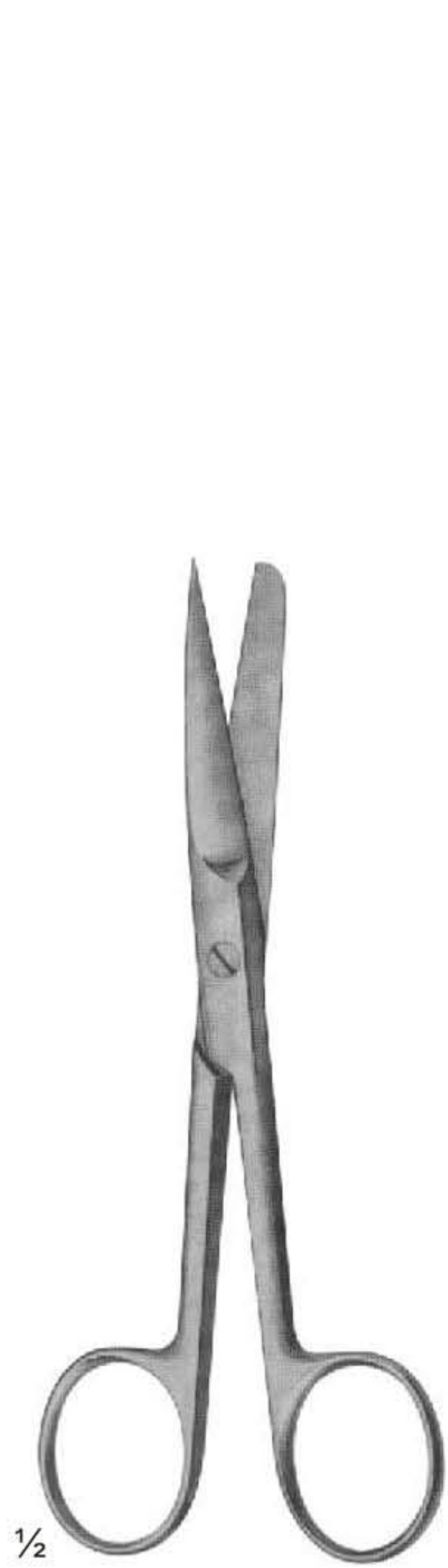

**03-204**  
Size: 145 mm

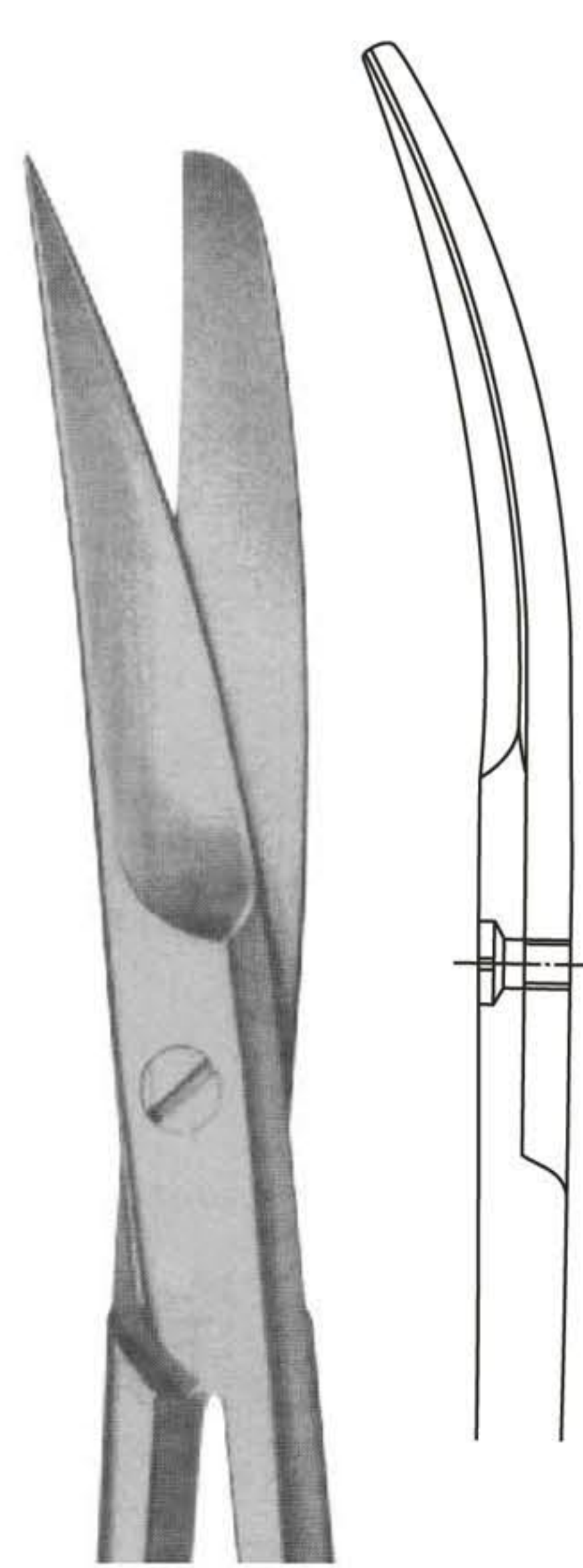

**03-205**  
Size: 145 mm

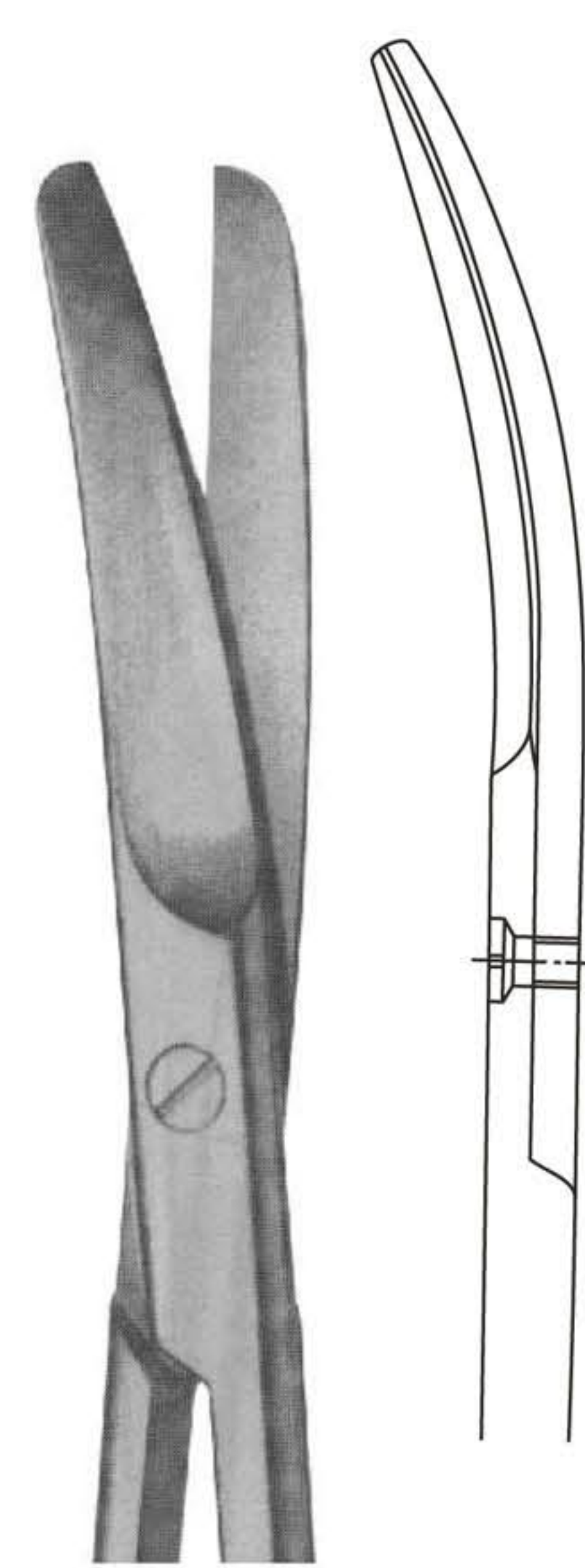

**03-206**  
Size: 145 mm

**03-204 - 206**  
DEAVER  
With flat lock

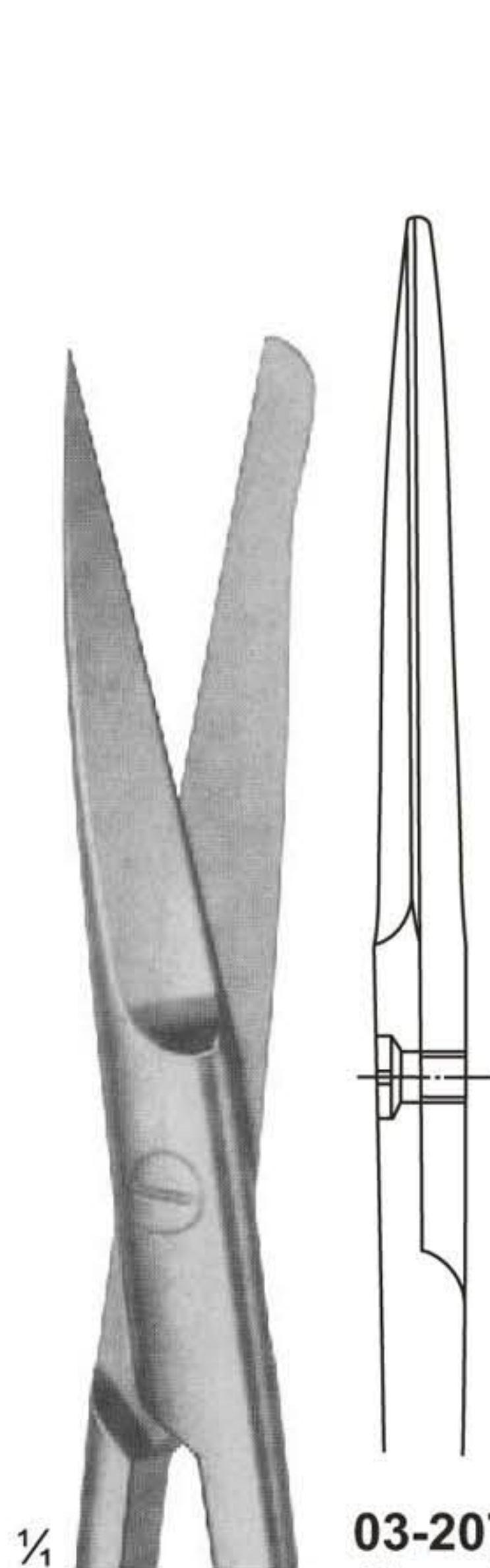

**03-207**  
Size: 130 mm

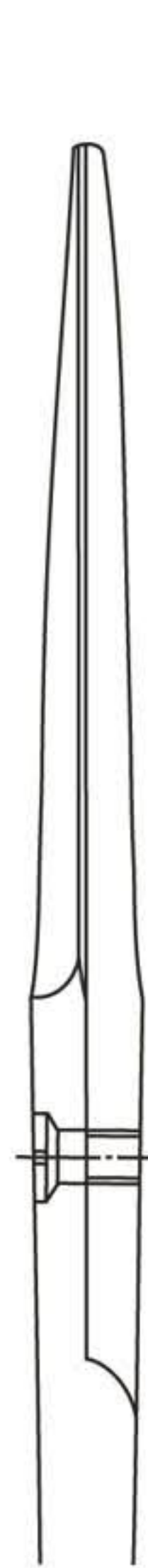

**03-208**  
Size: 145 mm



**03-209**  
Size: 165 mm

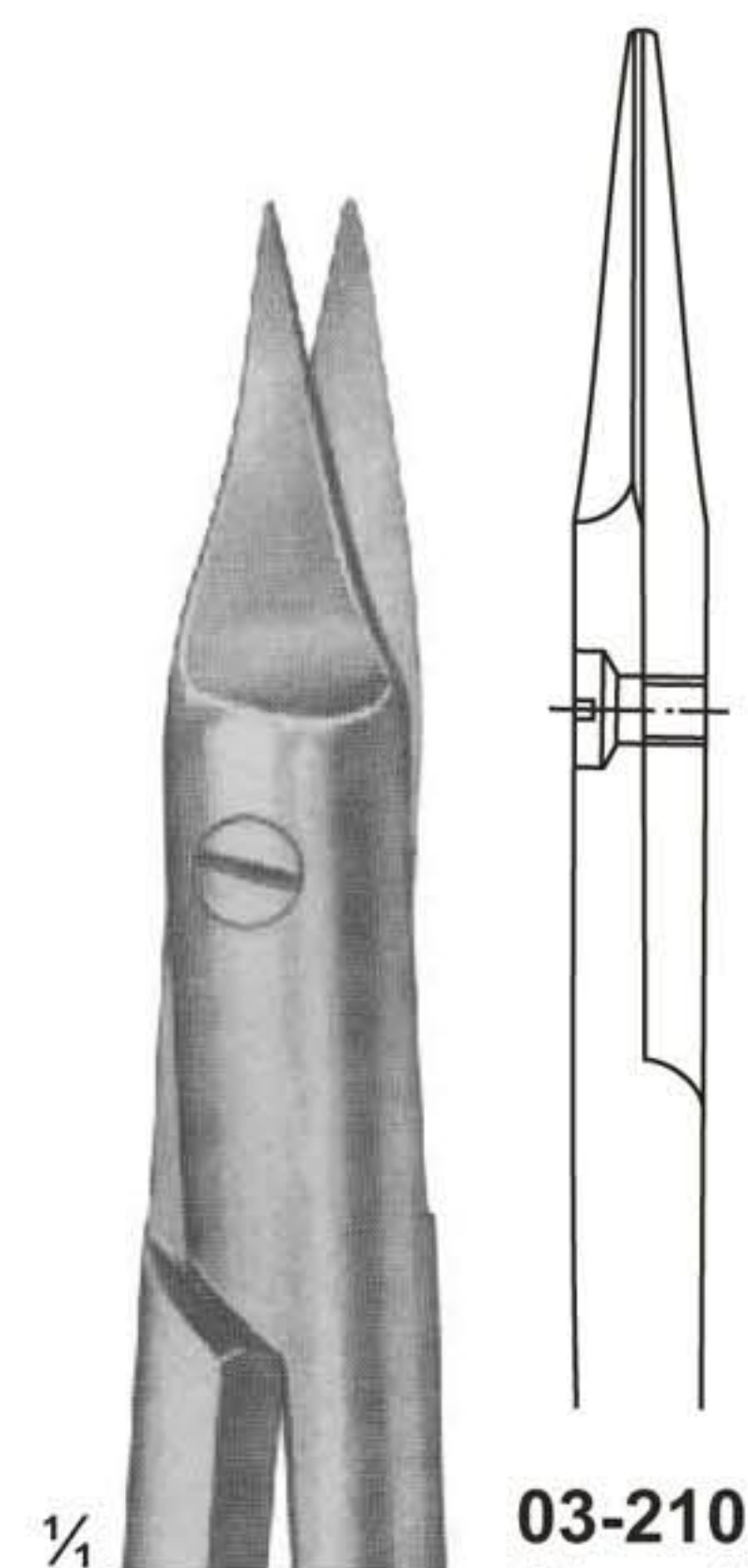
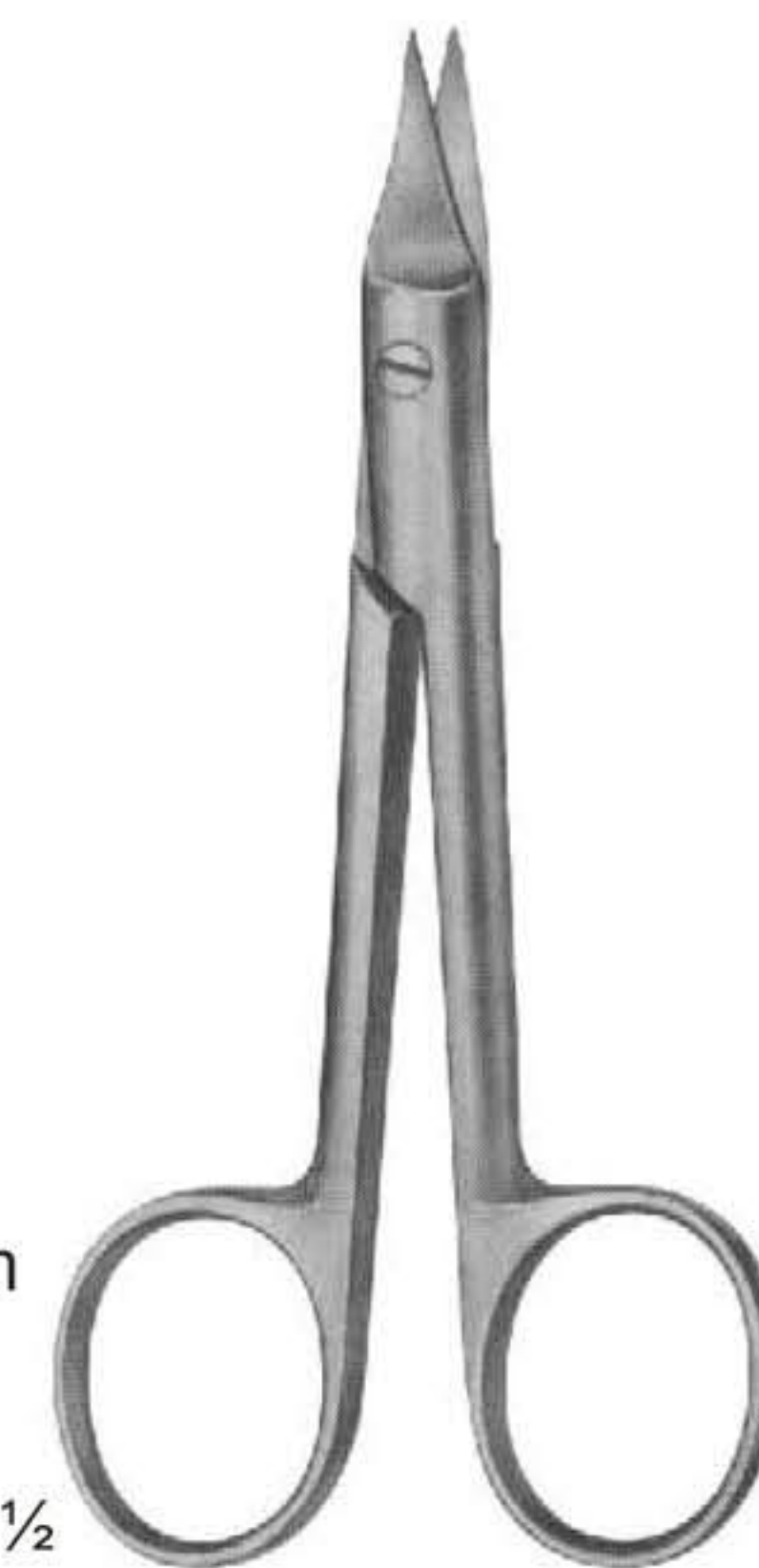

**03-210**  
Size: 130 mm

**03-207 - 209**  
Incision Scissors

**03-210**  
SYSTRUNK  
Nail Splitting Scissors



**Dissecting Scissors**

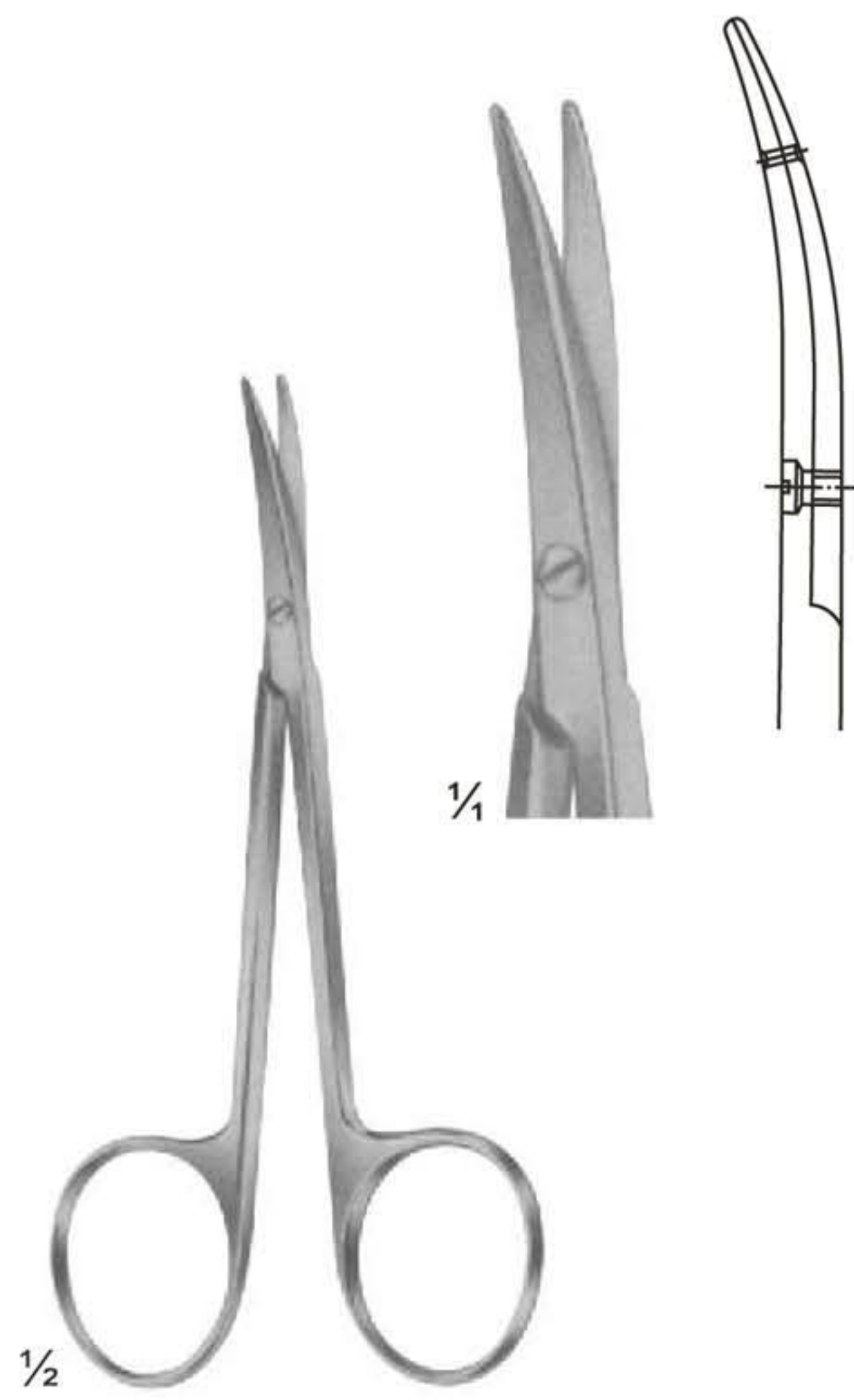

**03-211**  
**LITTLER**  
Dissecting Scissors  
Tips with eye for suture  
Size: 115 mm

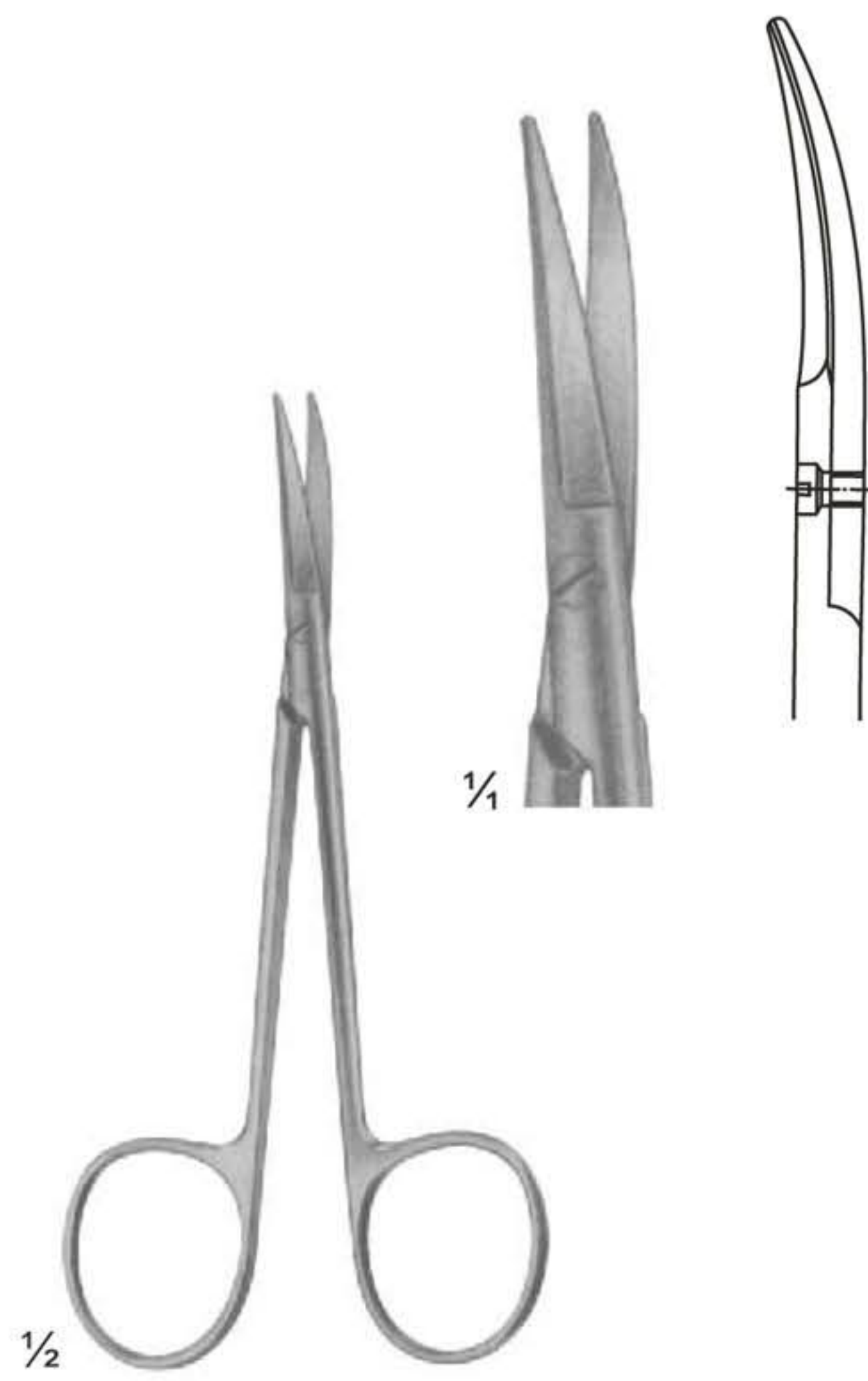

**03-212**  
**COTTLE**  
Bulldog Scissors  
Size: 115 mm

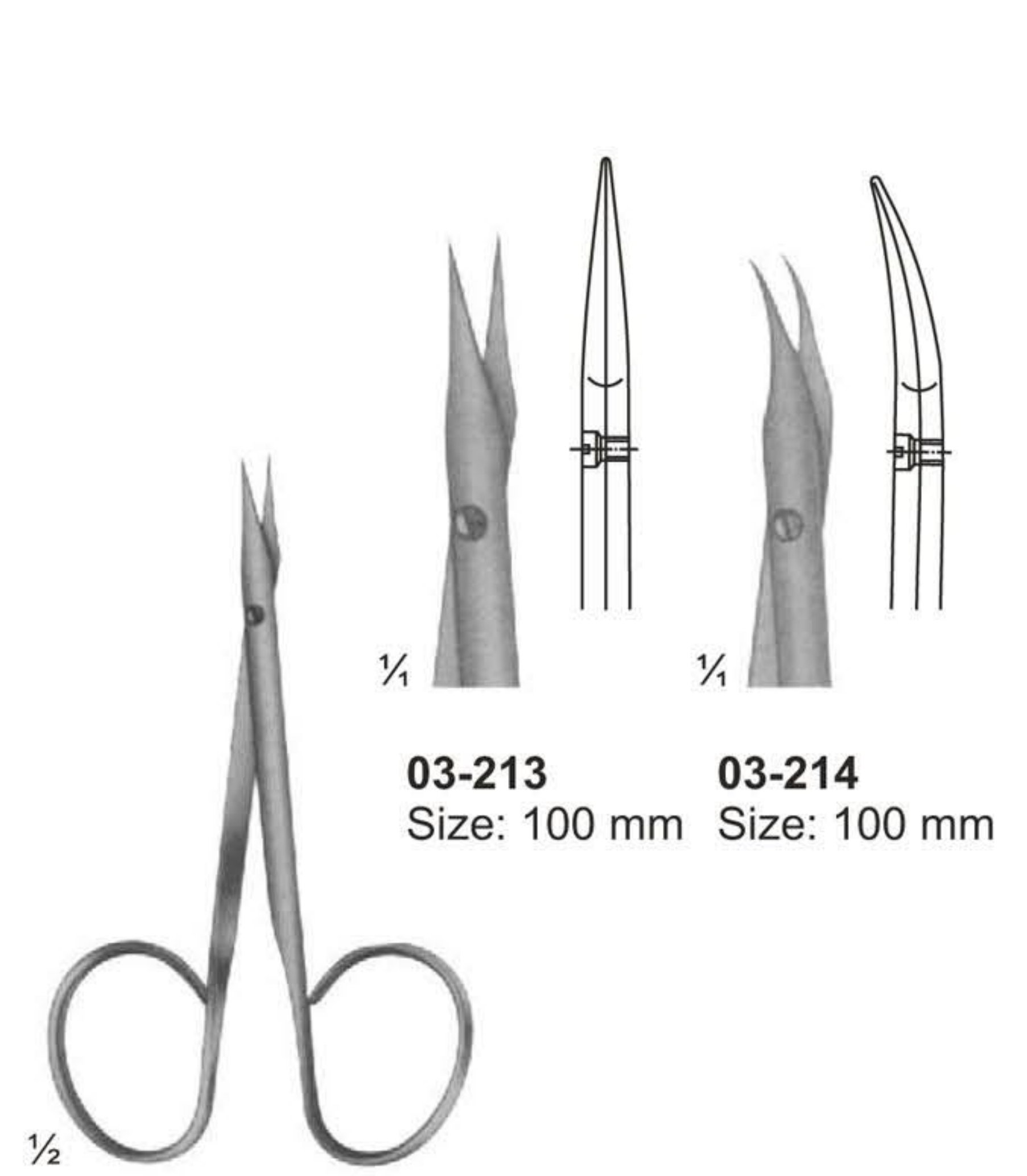

**03-213**      **03-214**  
Size: 100 mm    Size: 100 mm

**03-213 - 214**  
**STEVENS**  
Vessel and tendon Scissors  
Size: 100 mm

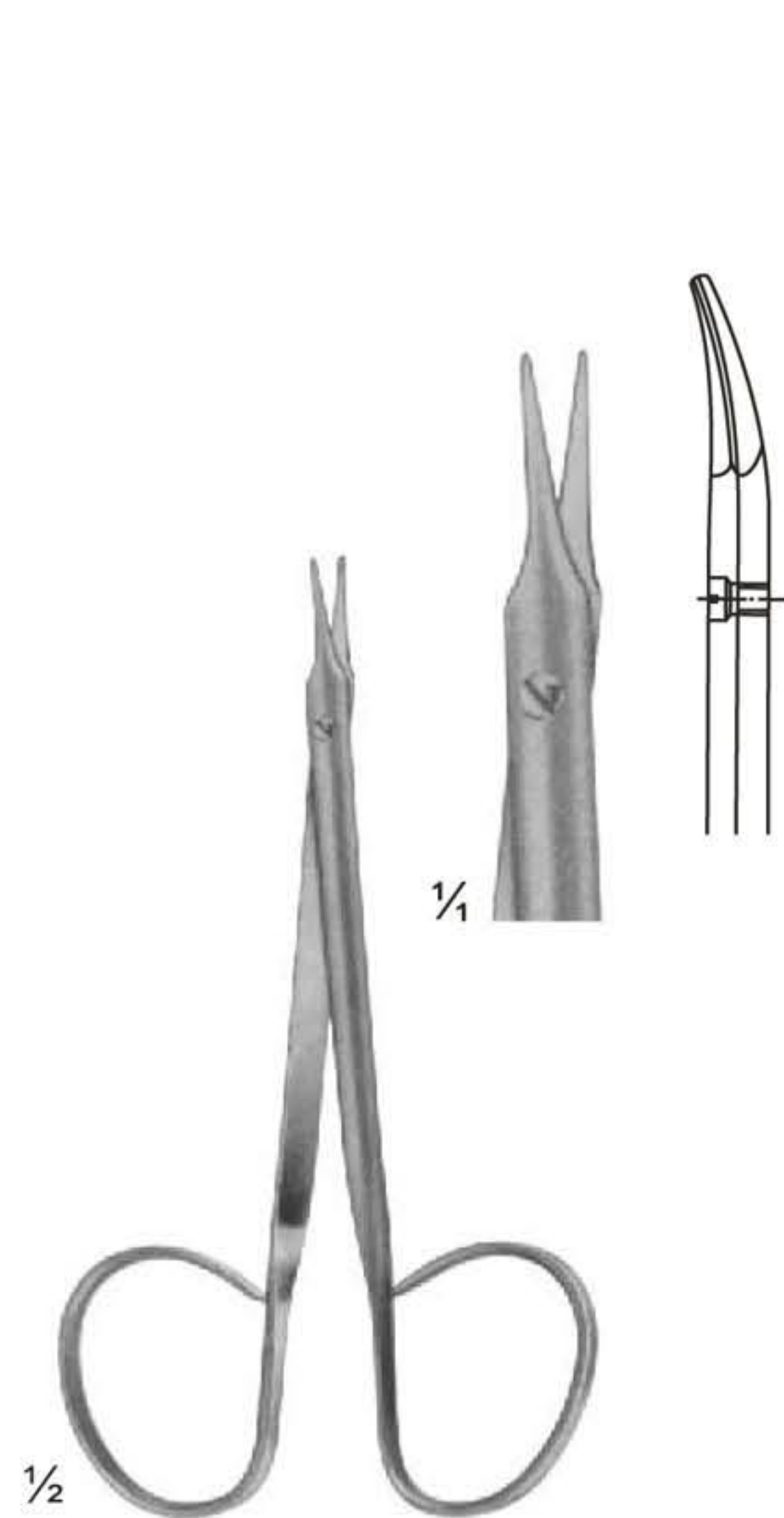

**03-215**  
**STEVENS**  
Fine Dissecting Scissors  
Size: 110 mm

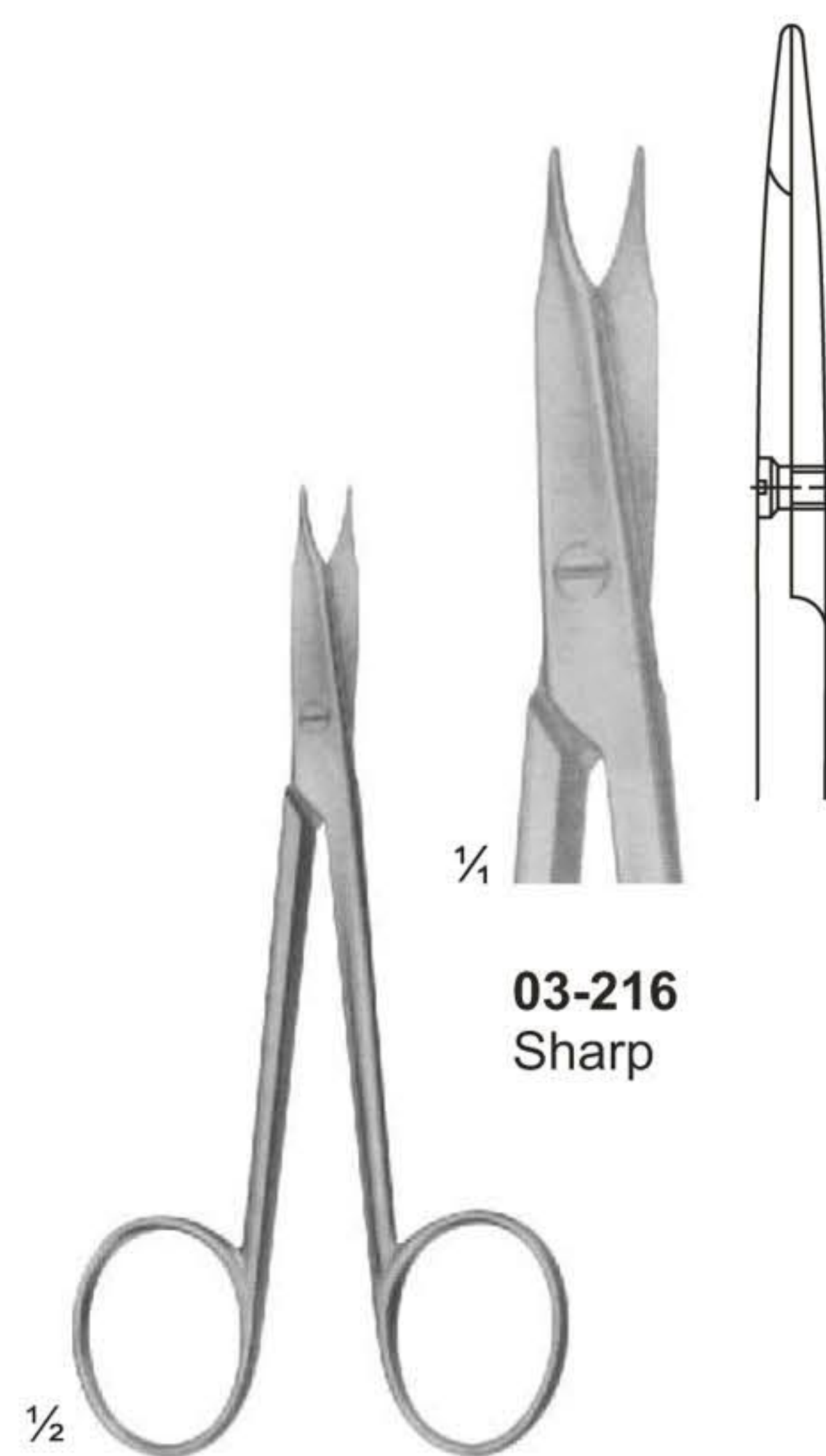

**03-216 - 219**  
**STEVENS**  
Vessel and tendon Scissors  
Size: 110 mm

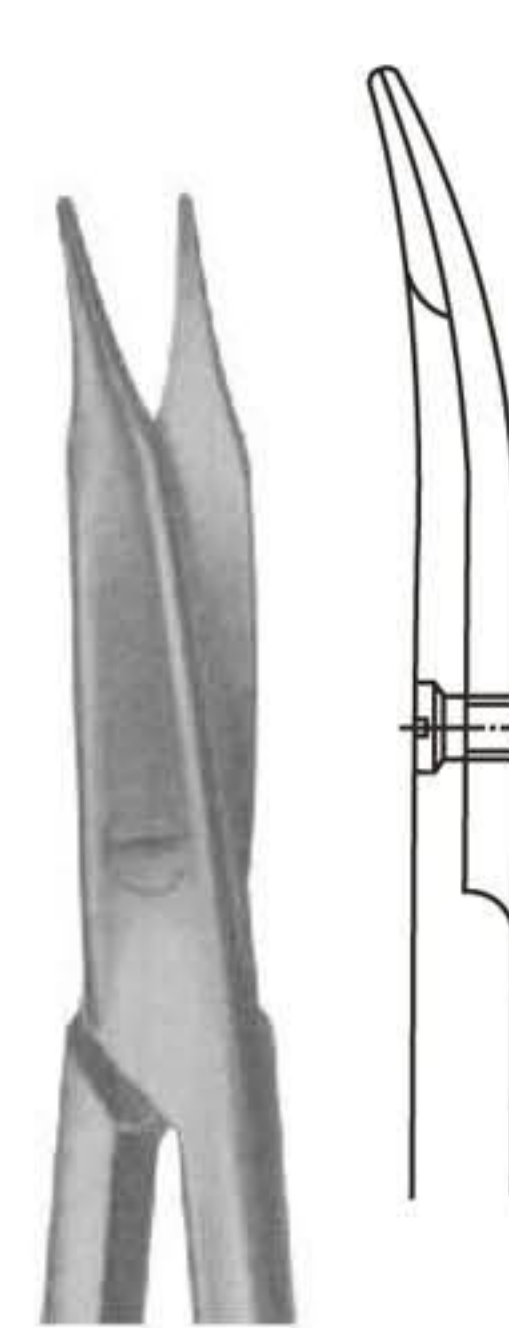

**03-217**  
Sharp

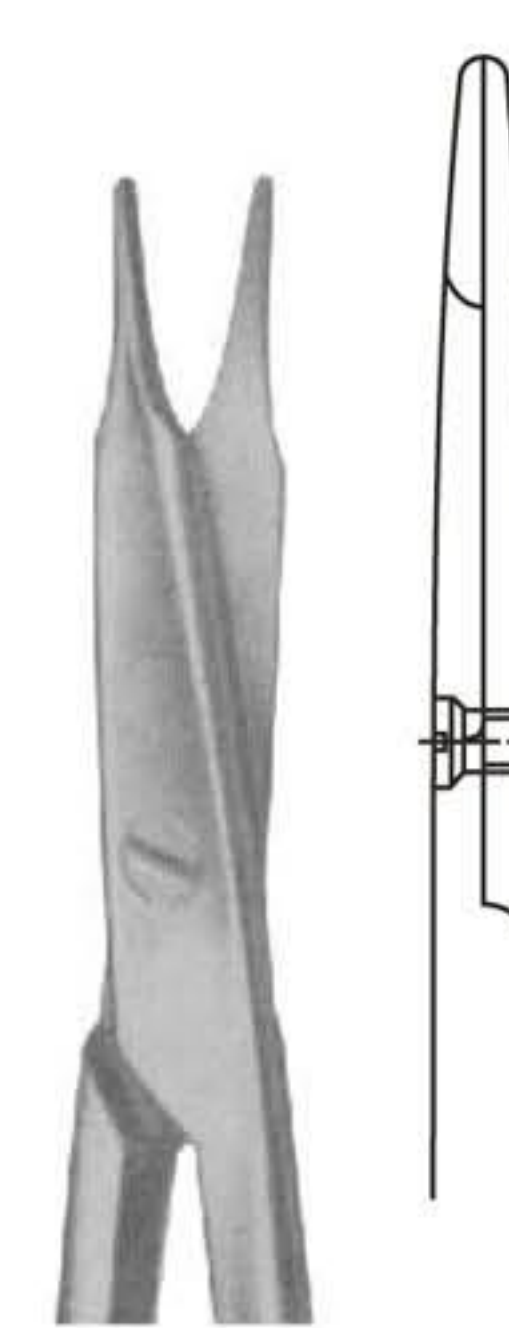

**03-218**  
Blunt

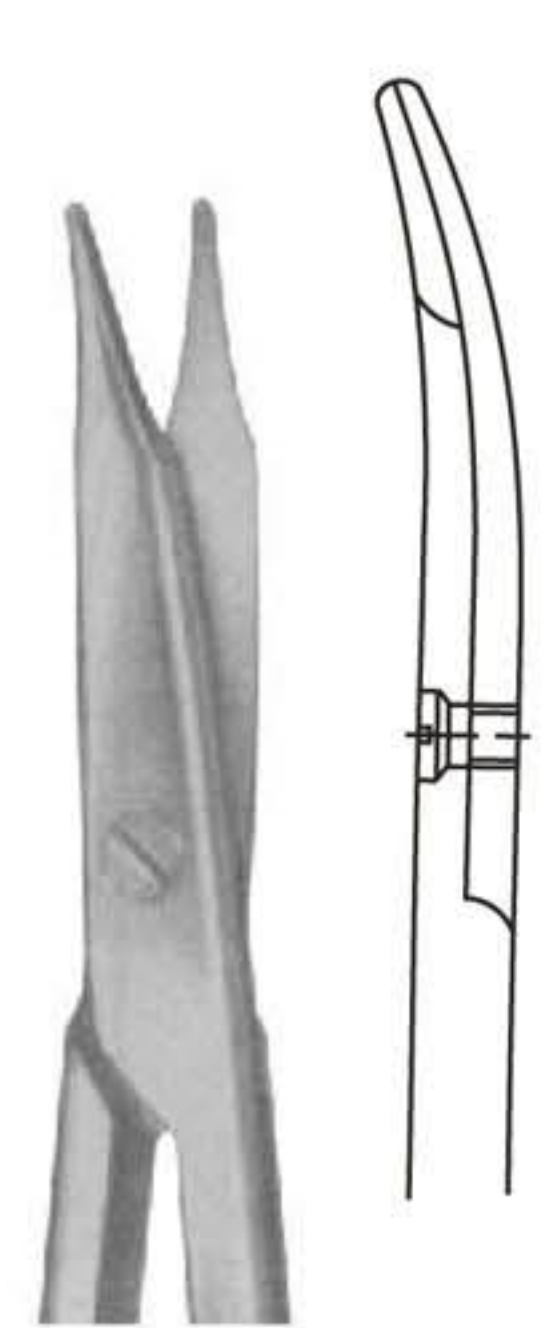

**03-219**  
Blunt



# Dissecting Scissors

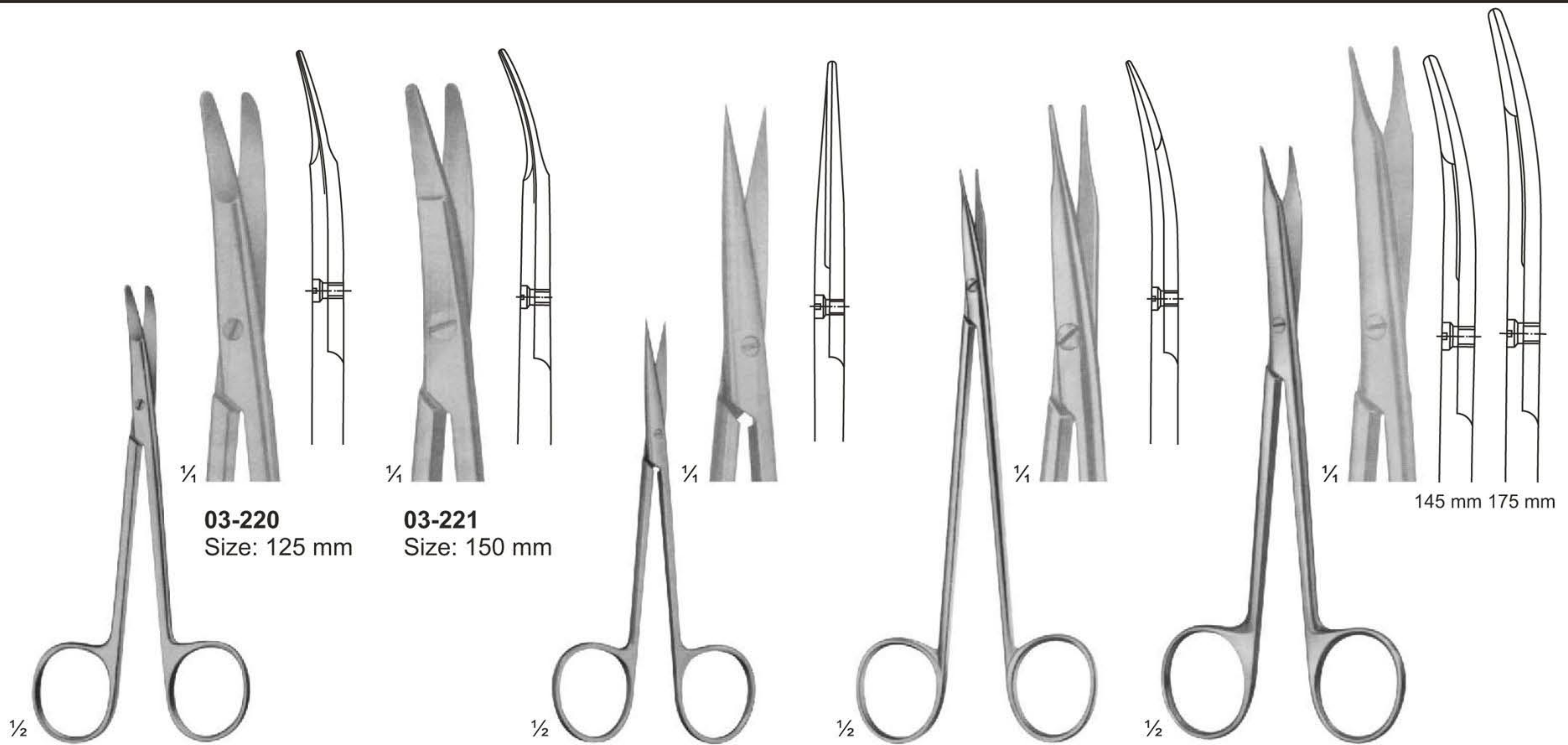

**03-220 - 221**  
KILNER  
Special flat points for dissecting and undermining the skin

**03-222**  
KILNER  
Fine dissecting scissors  
Size: 115 mm

**03-223**  
JAMESON  
Dissecting scissors  
Size: 150 mm

**03-224**  
REYNOLDS  
Dissecting scissors  
Size: 145 - 175 mm

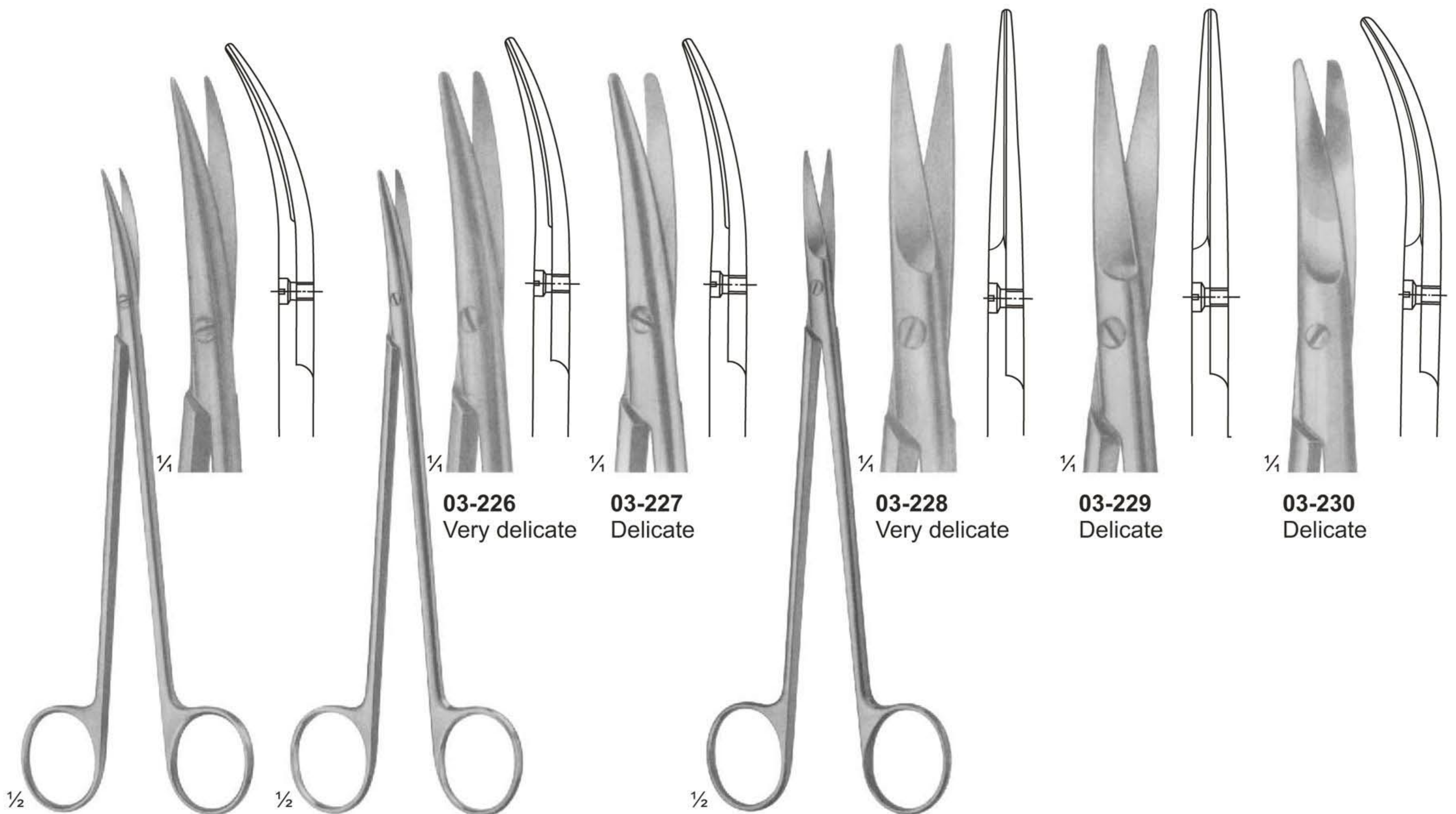

**03-225**  
DE BAKEY  
Ateriotomy scissors  
Size: 175 mm

**03-226 - 227**  
TOENNIS ADSON  
Dissecting scissors  
Size: 175 mm

**03-228 - 230**  
TOENNIS  
Dissecting scissors  
Size: 150 mm



# Dissecting & Surgical Scissors

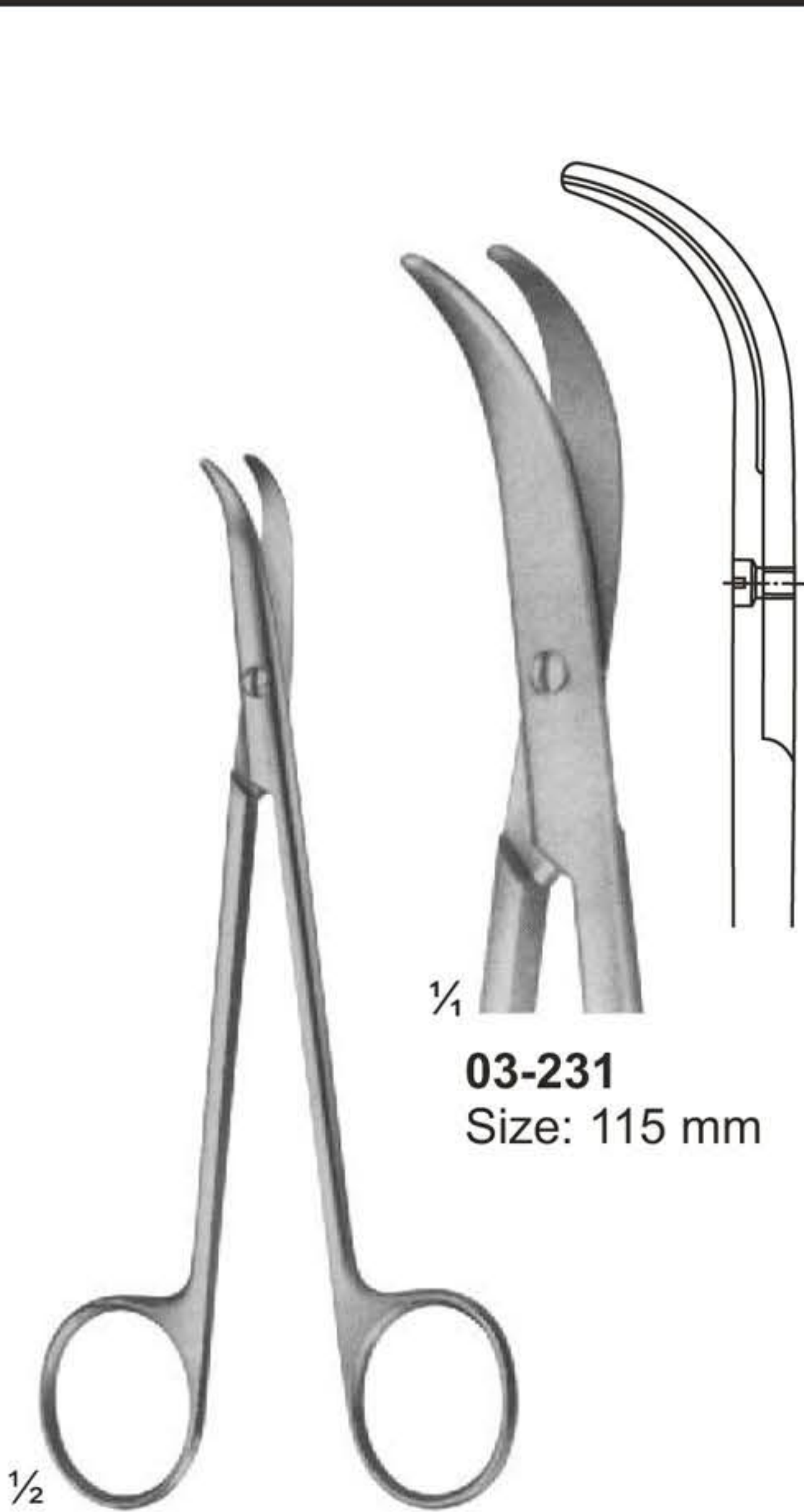

**03-231**  
Size: 115 mm

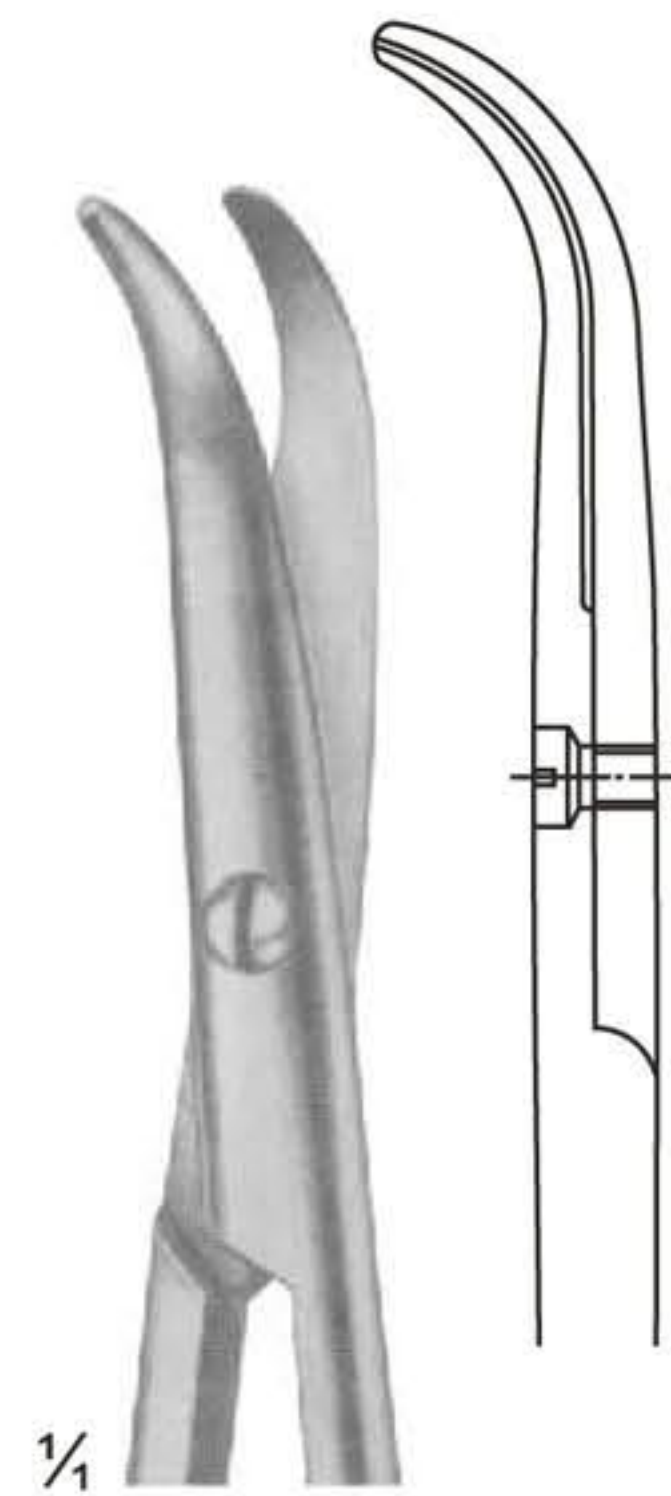

**03-232**  
Size: 135 mm

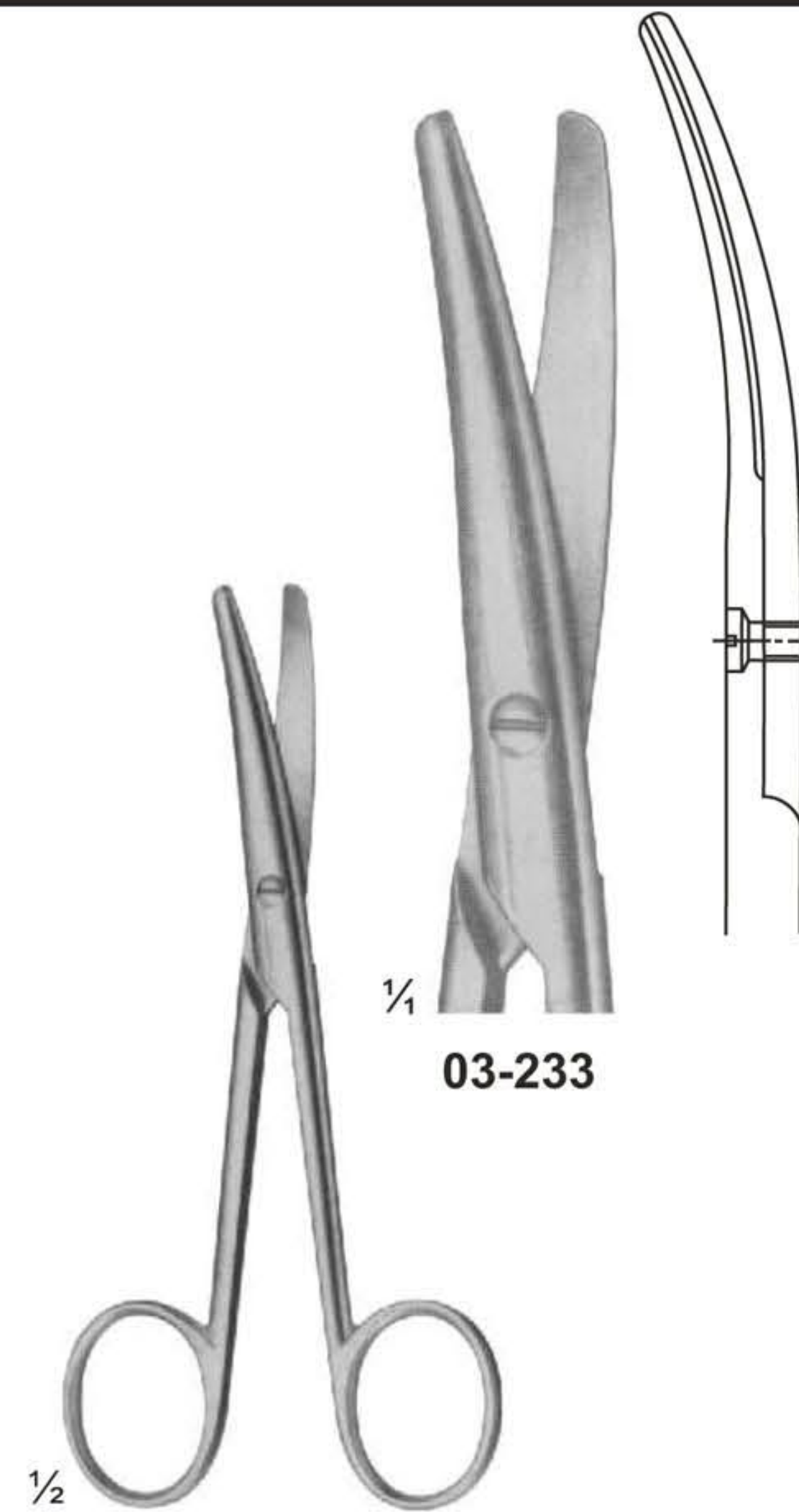

**03-233**

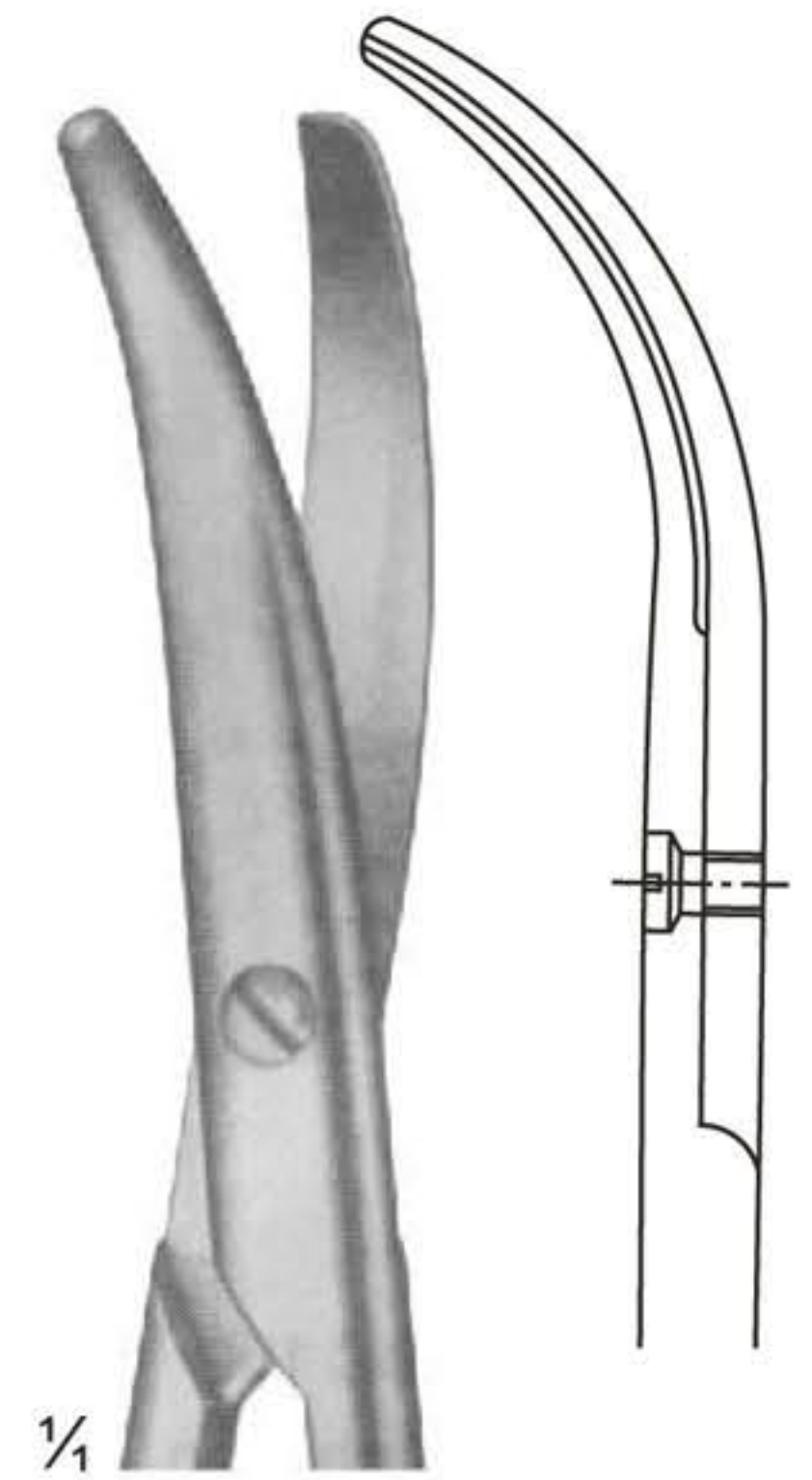

**03-234**

**03-231 - 232**  
FOMON  
Lower lateral scissors

**03-233 - 234**  
LANDOLT  
Enucleation scissors  
Size: 120 mm

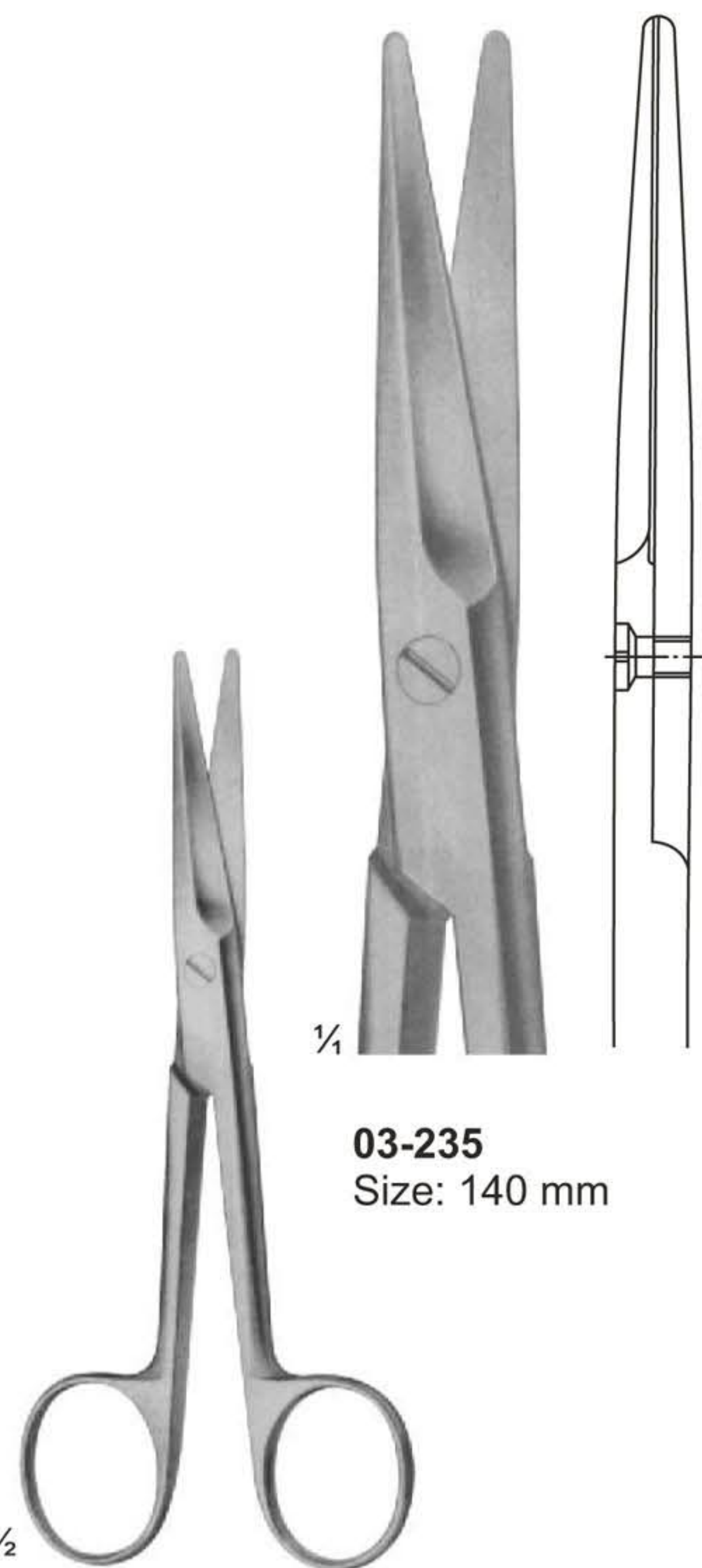

**03-235**  
Size: 140 mm

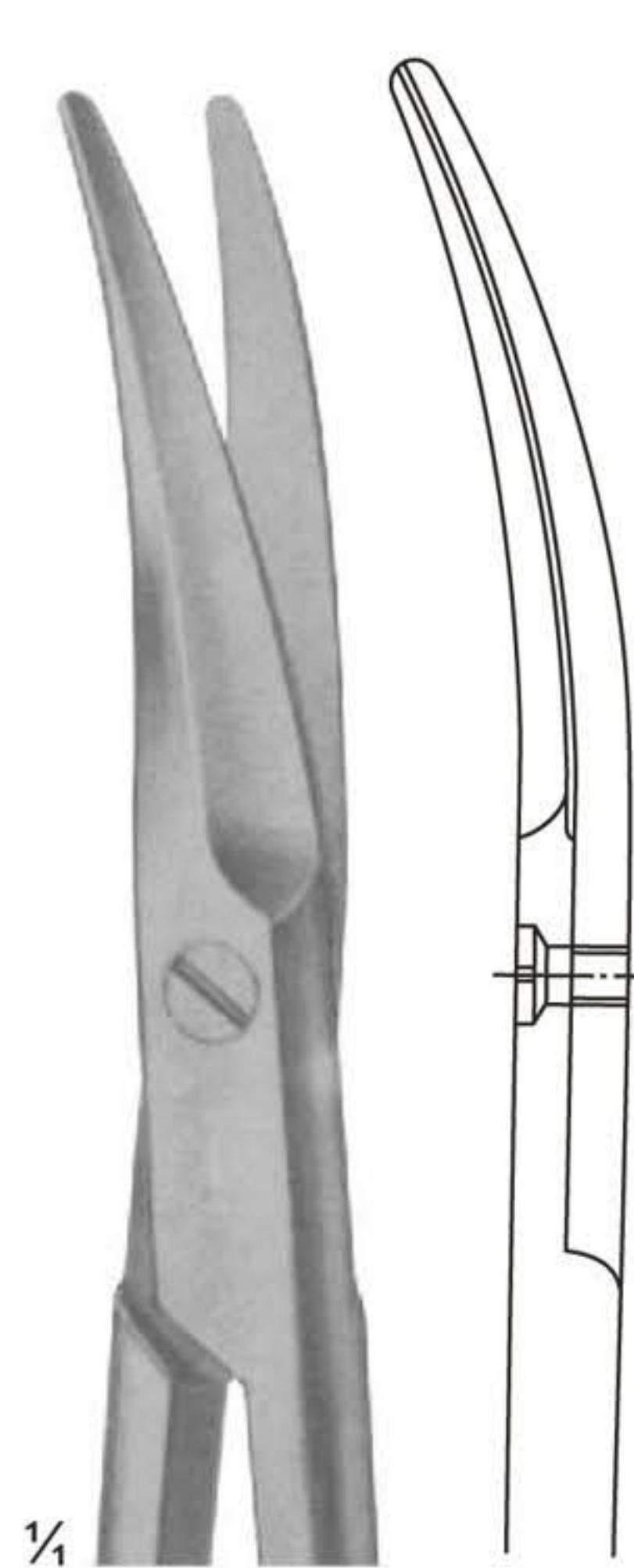

**03-238 - 240**  
MAYO  
**03-238** (140 mm)  
**03-239** (155 mm)  
**03-240** (170 mm)

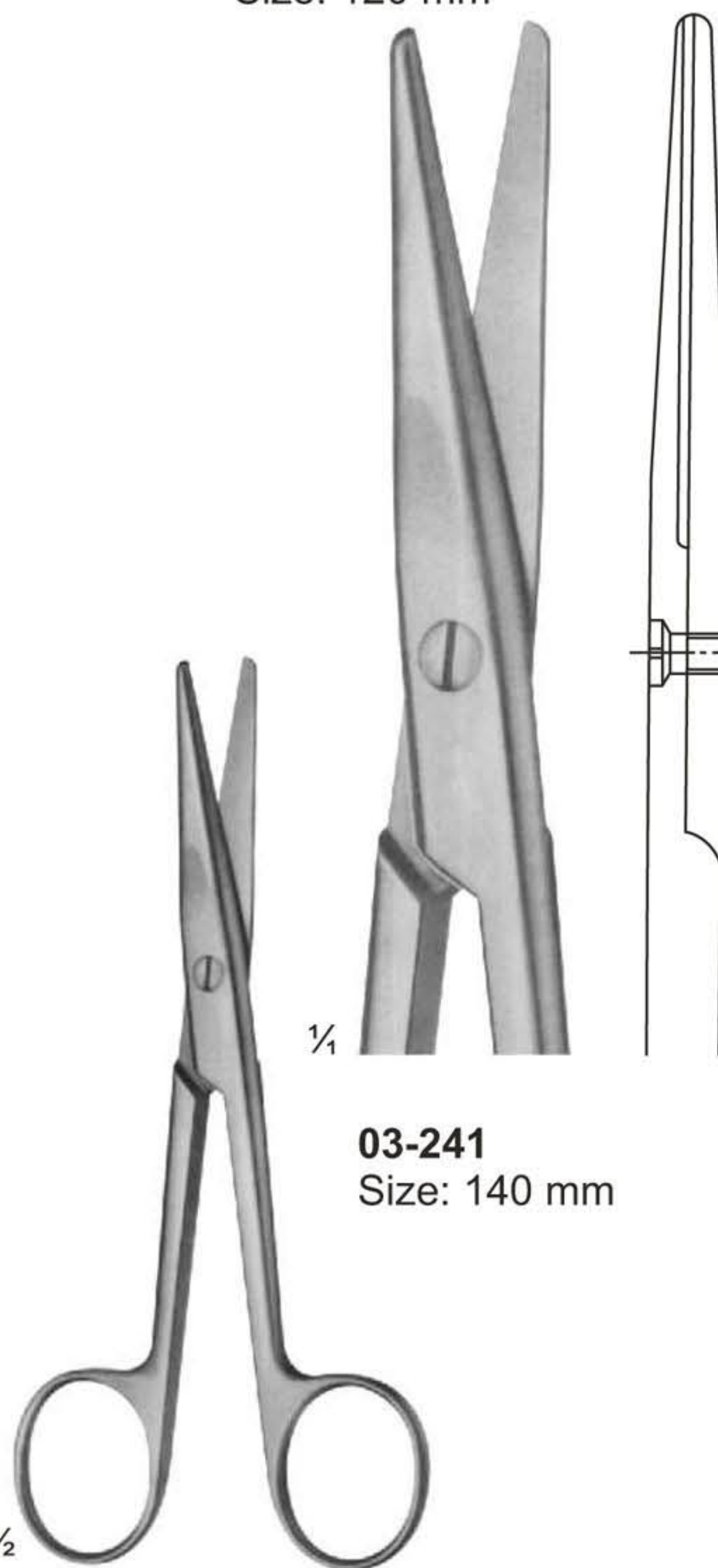

**03-241**  
Size: 140 mm

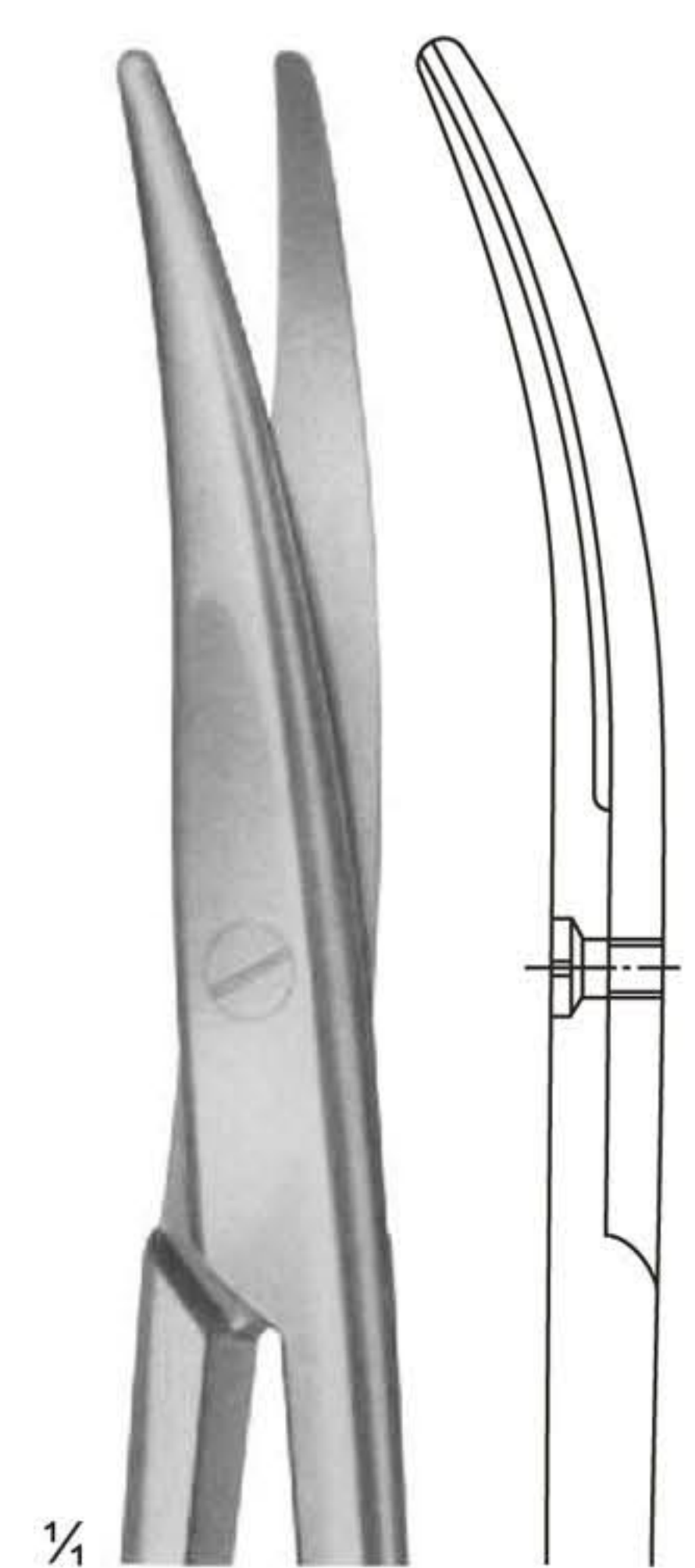

**03-243 - 244**  
MAYO-STILLE  
**03-243** (140 mm)  
**03-244** (170 mm)

**03-235 - 237**  
MAYO  
**03-235** (140 mm)  
**03-236** (155 mm)  
**03-237** (170 mm)

**03-241 - 242**  
MAYO-STILLE  
**03-241** (140 mm)  
**03-242** (170 mm)



# Dissecting Scissors

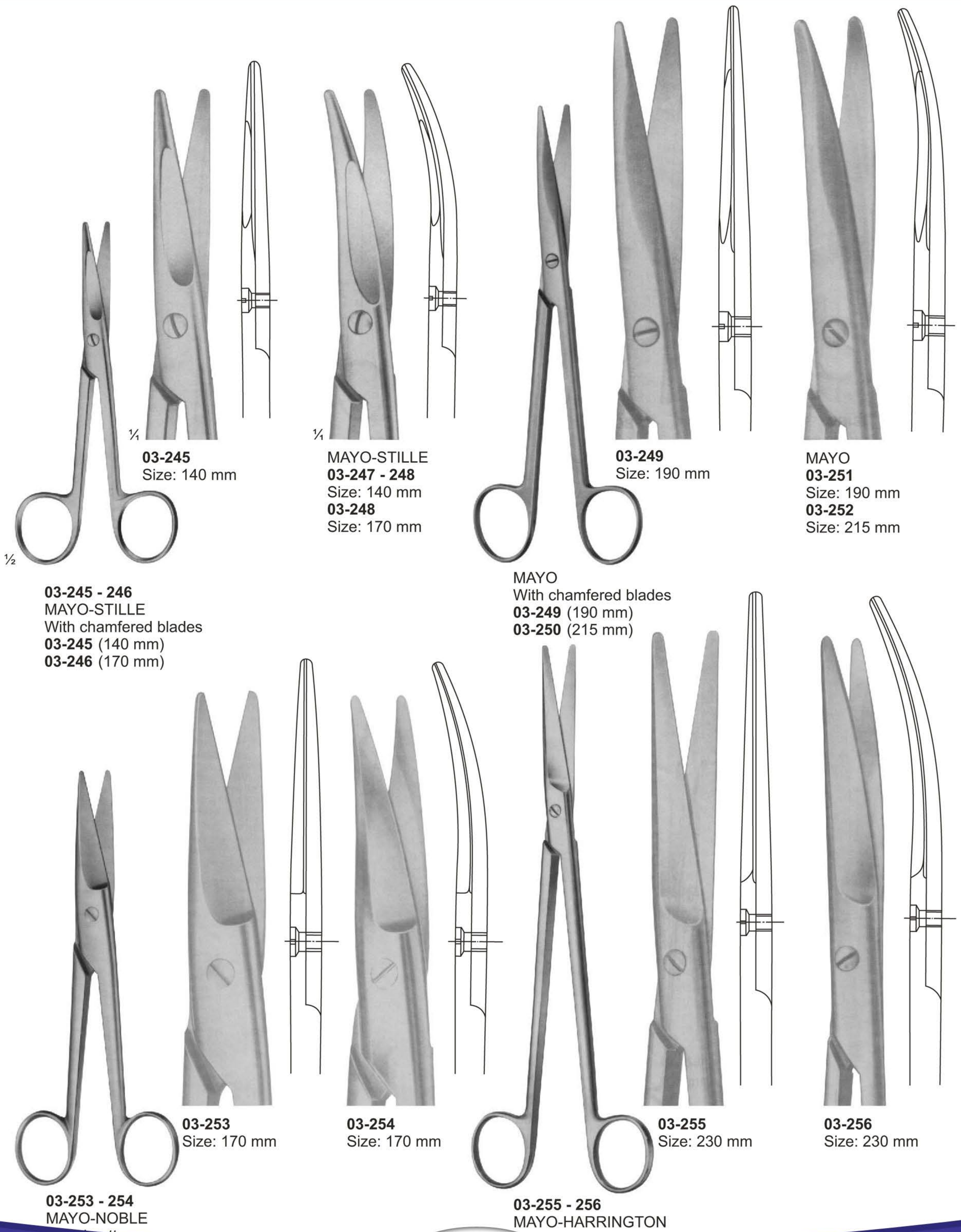



**Dissecting Scissors**

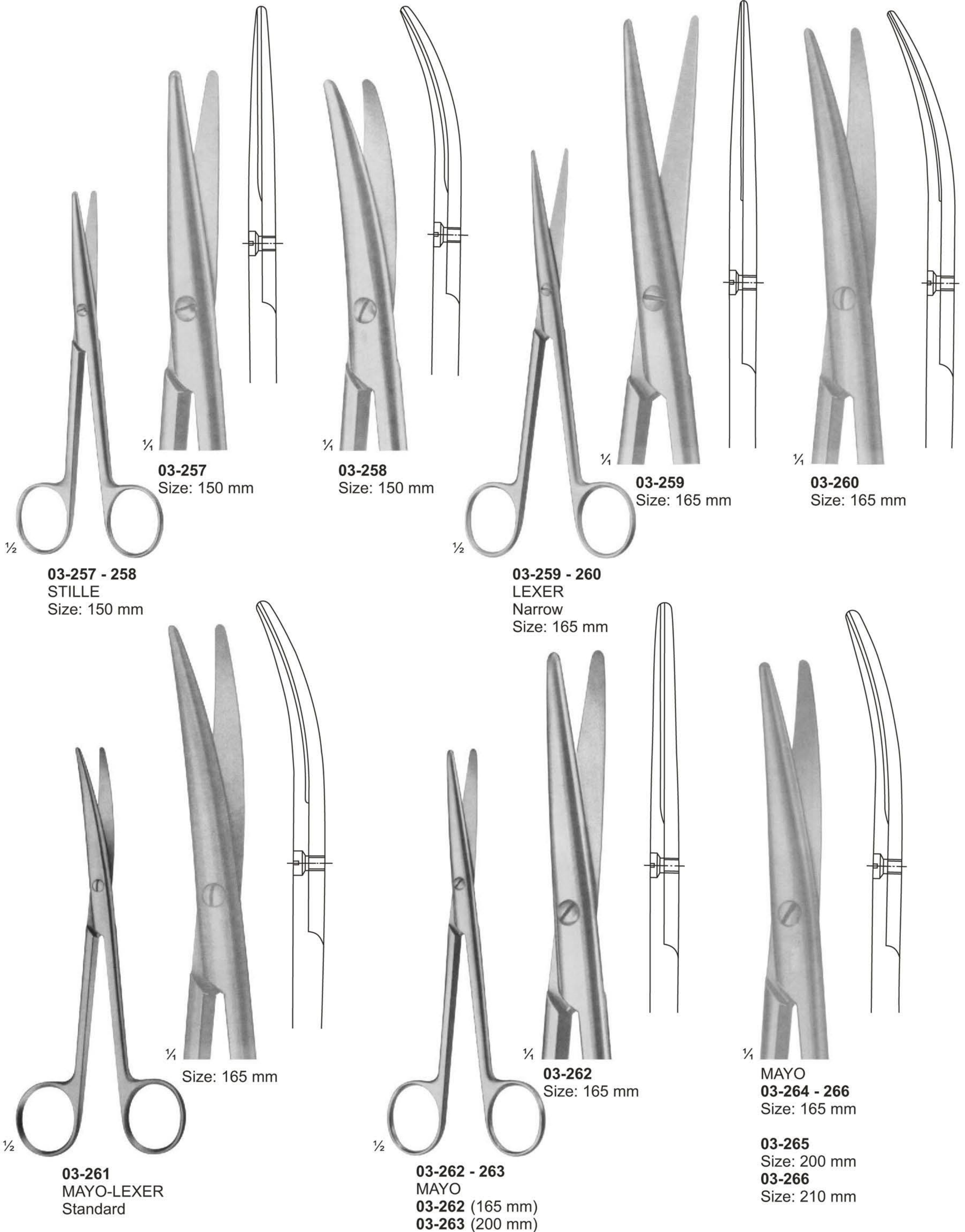



**Dissecting Scissors**

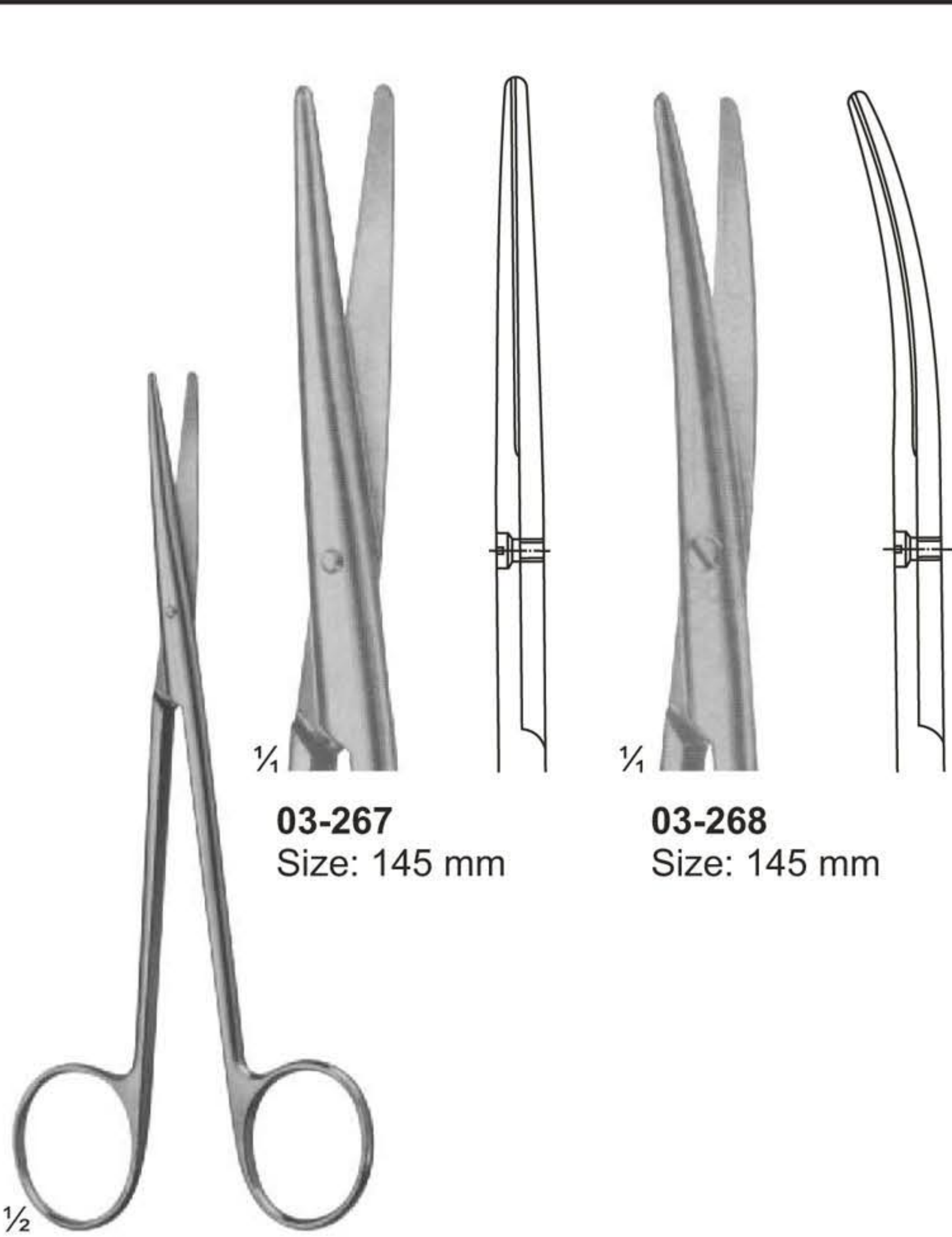

**03-267**  
Size: 145 mm

**03-268**  
Size: 145 mm

**03-267 - 268**  
BABY - METZENBAUM

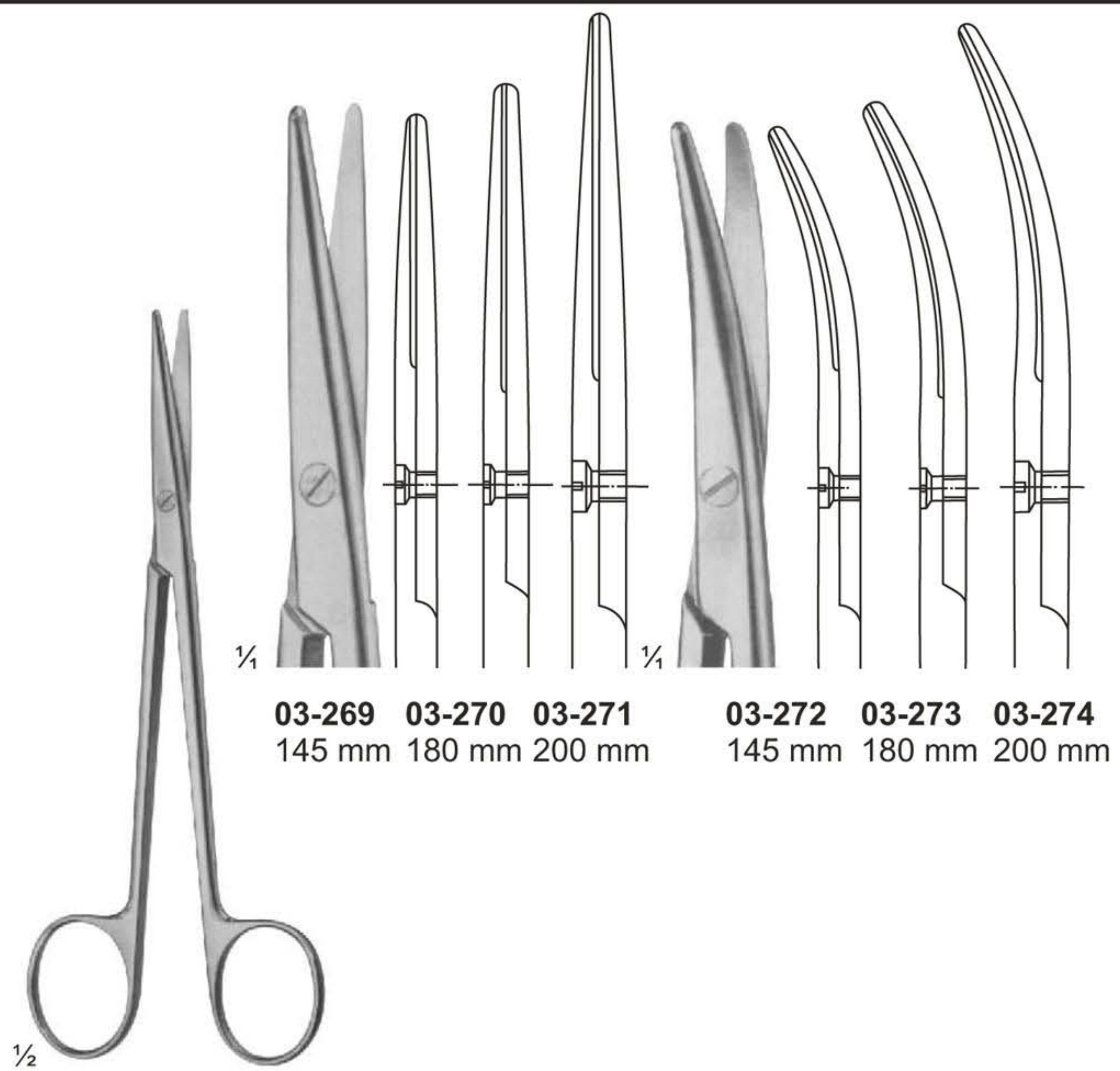

**03-269** 145 mm  
**03-270** 180 mm  
**03-271** 200 mm

**03-272** 145 mm  
**03-273** 180 mm  
**03-274** 200 mm

**03-269 - 274**  
METZENBAUM



**03-275 - 282**  
NELSON - METZENBAUM

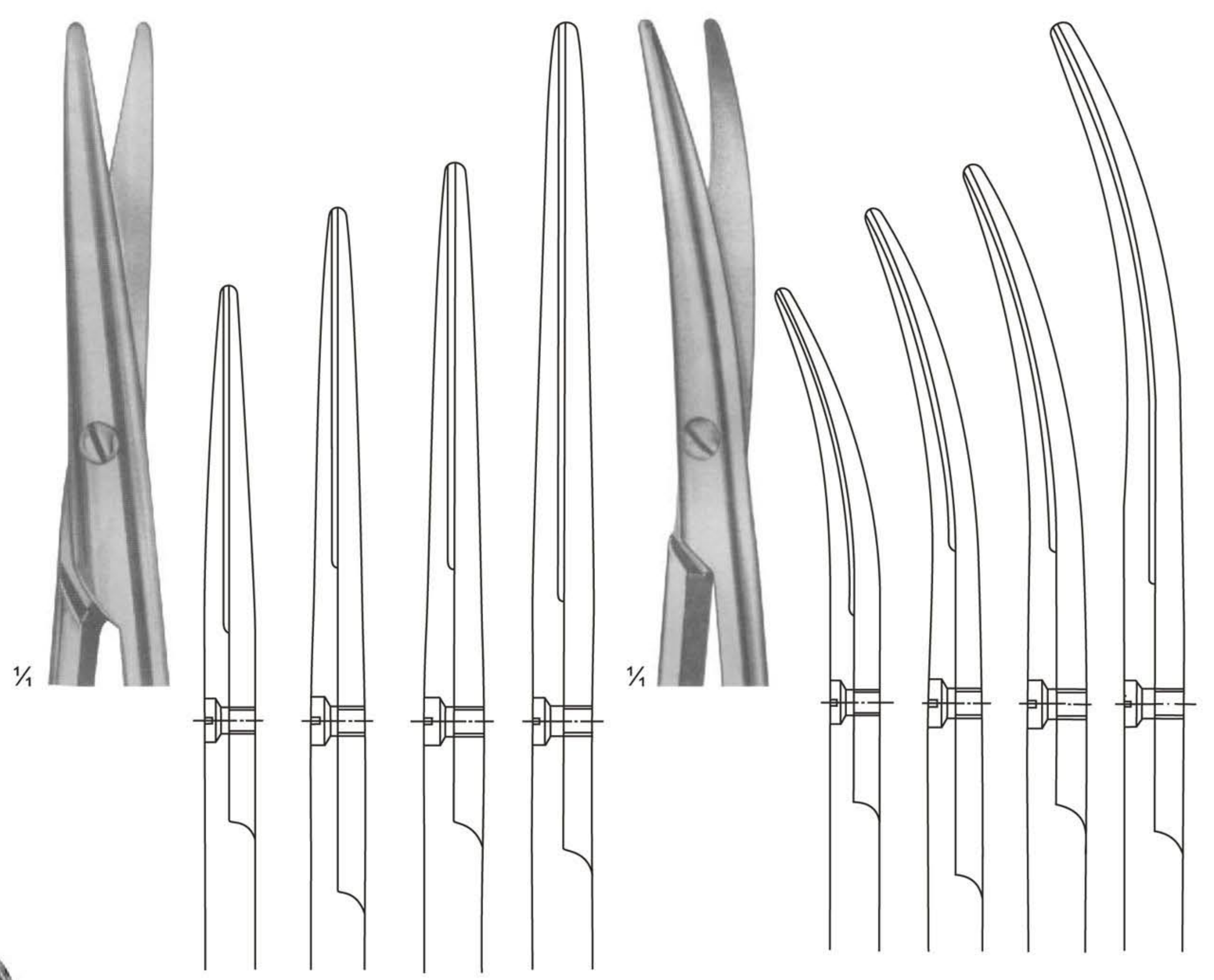

**03-275** 230 mm  
**03-276** 250 mm  
**03-277** 280 mm  
**03-278** 305 mm

**03-279** 230 mm  
**03-280** 250 mm  
**03-281** 280 mm  
**03-282** 305 mm



# Vessel Scissors

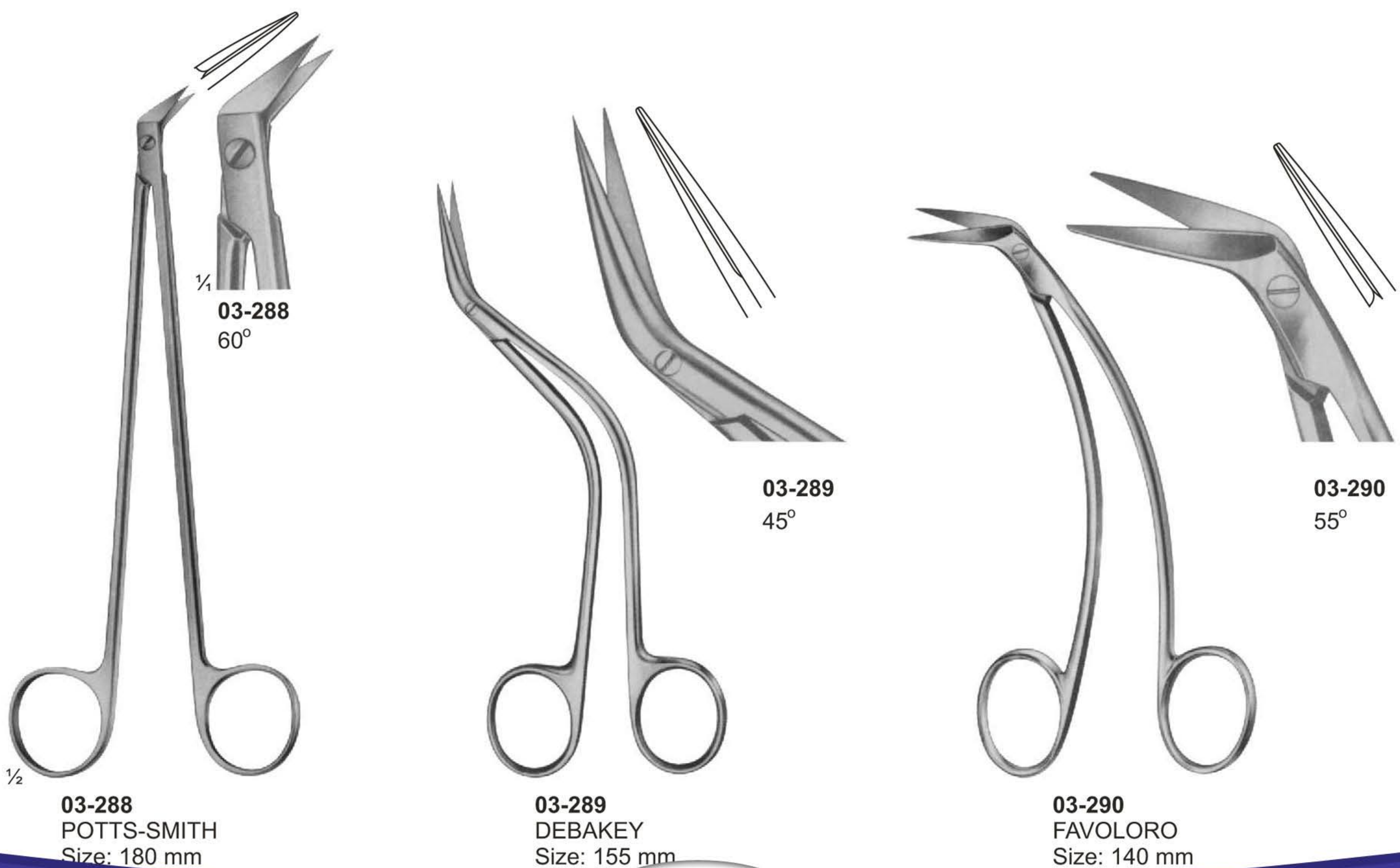
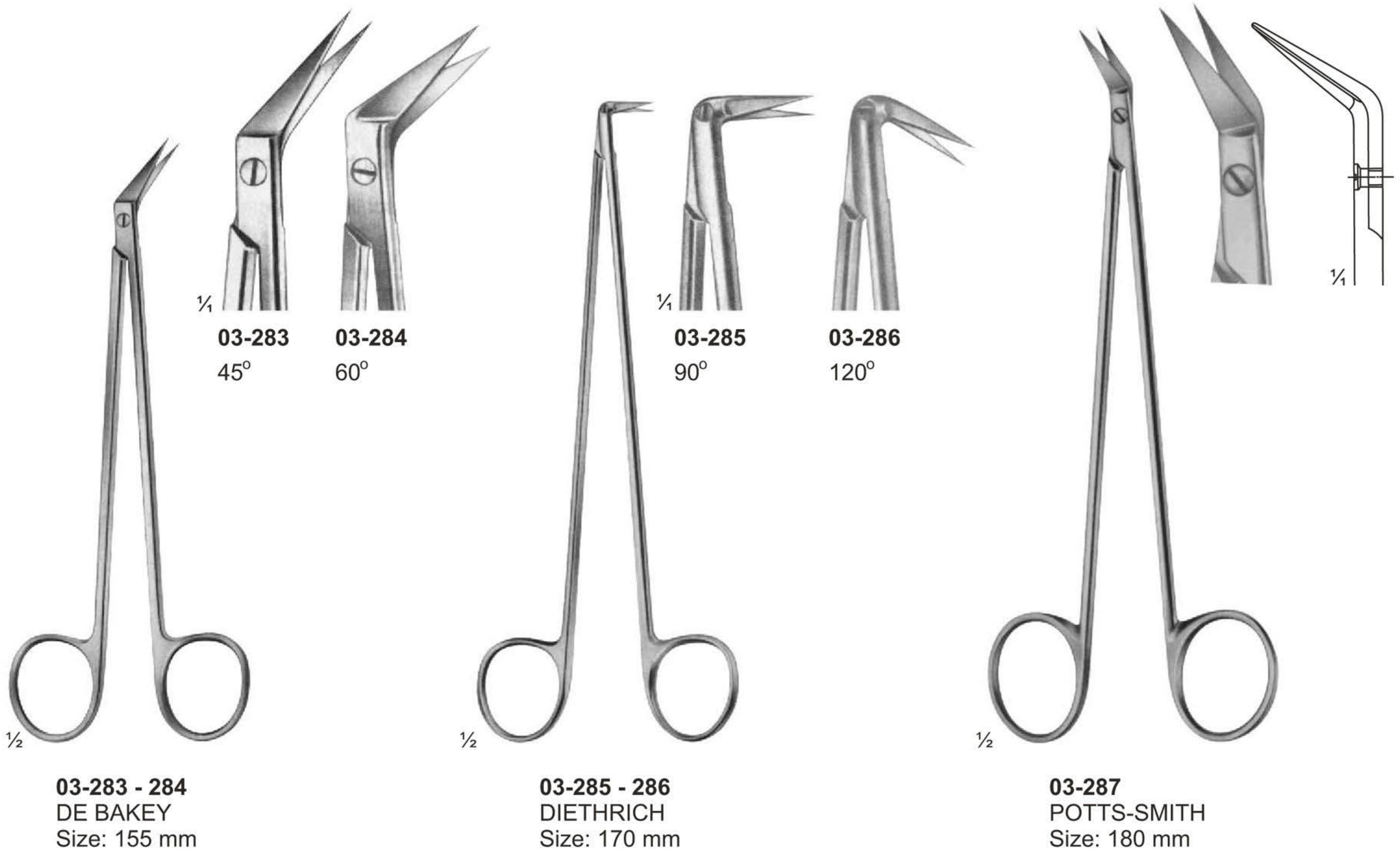



**Cardiovascular and Neuro-Surgery Scissors**



**03-291**  
OLIVECRONA  
Dura Scissors



**03-292**  
STRULLY  
Pointed  
Size: 220 mm

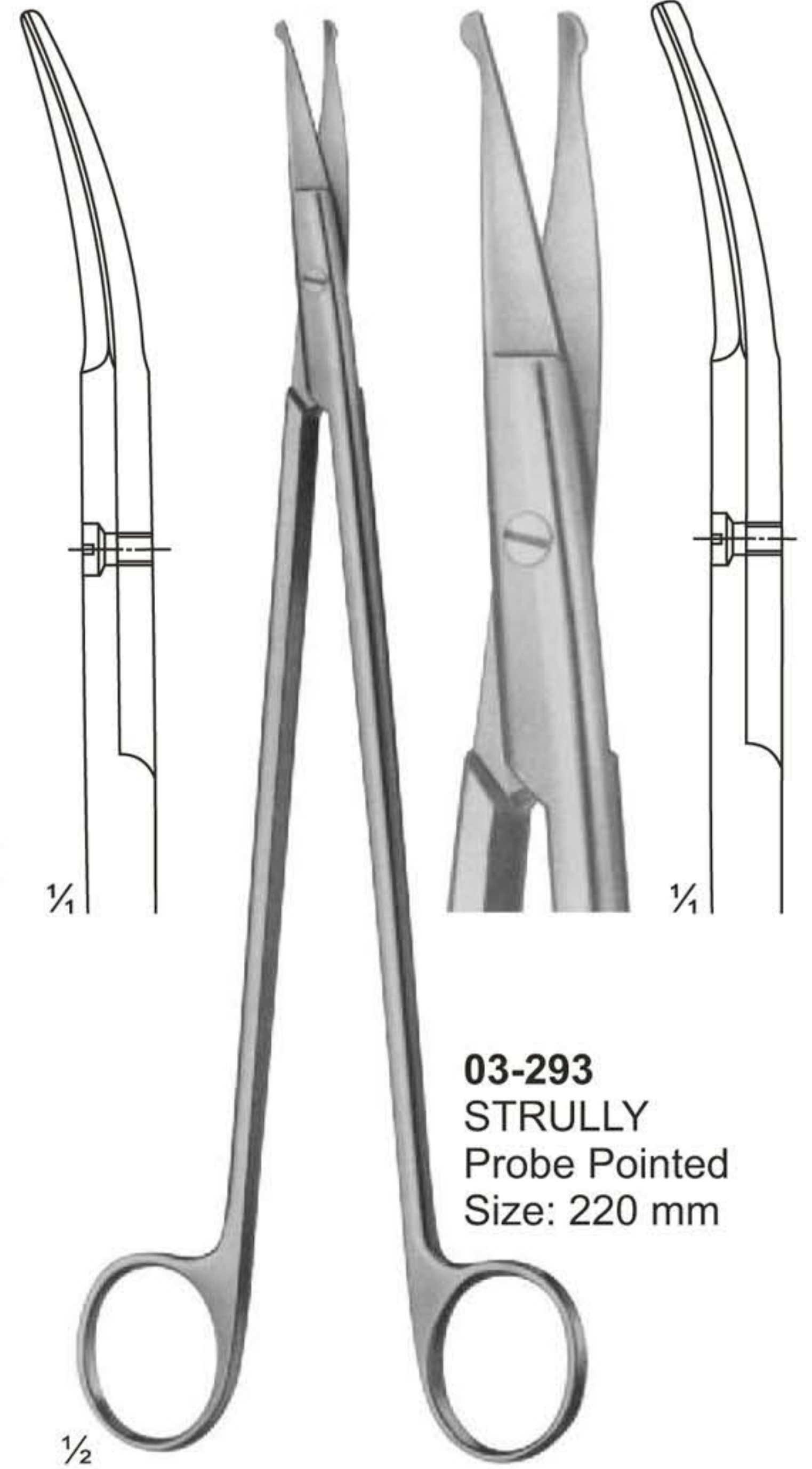

**03-293**  
STRULLY  
Probe Pointed  
Size: 220 mm

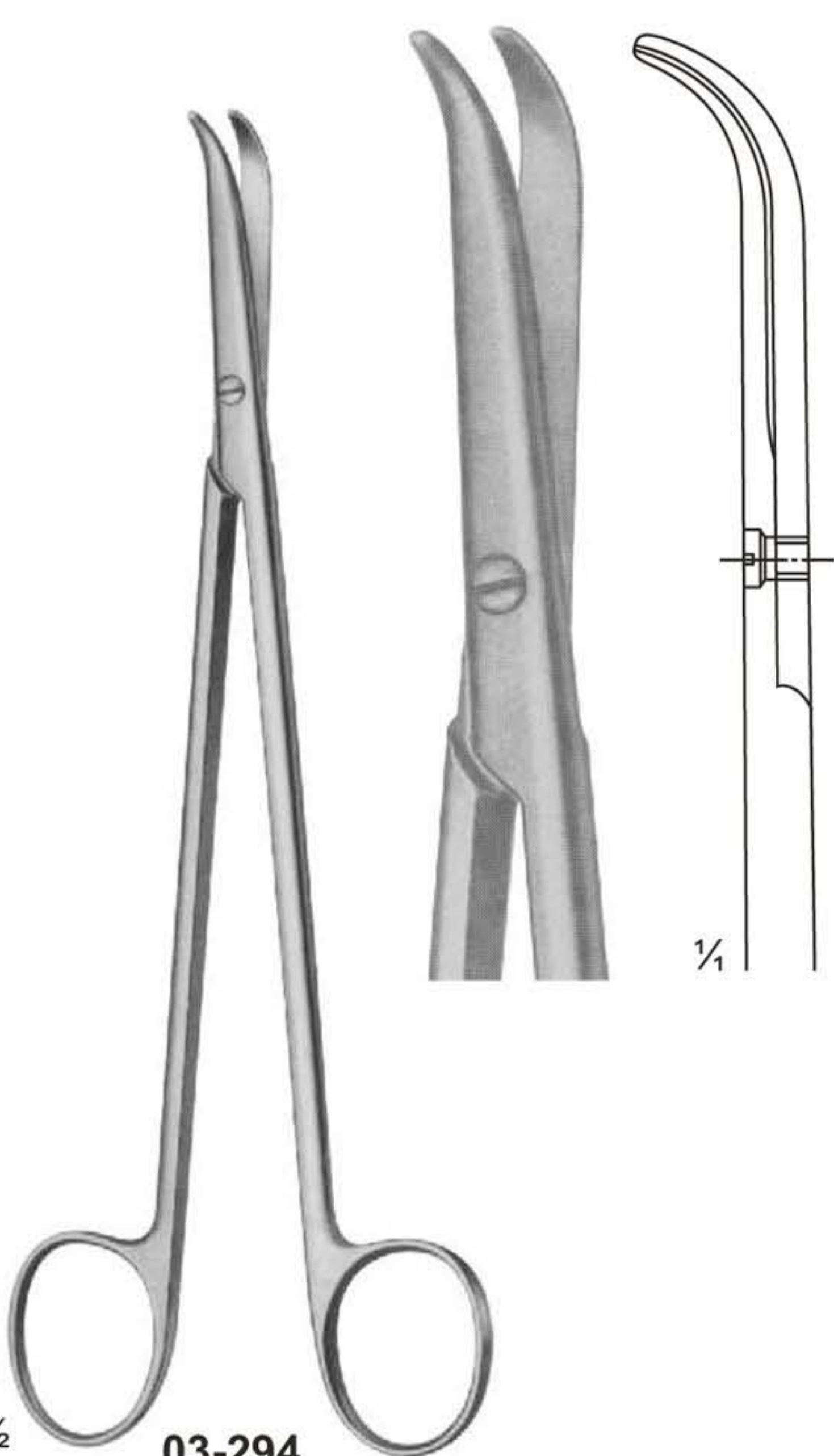

**03-294**  
THOREK  
Size: 180 mm

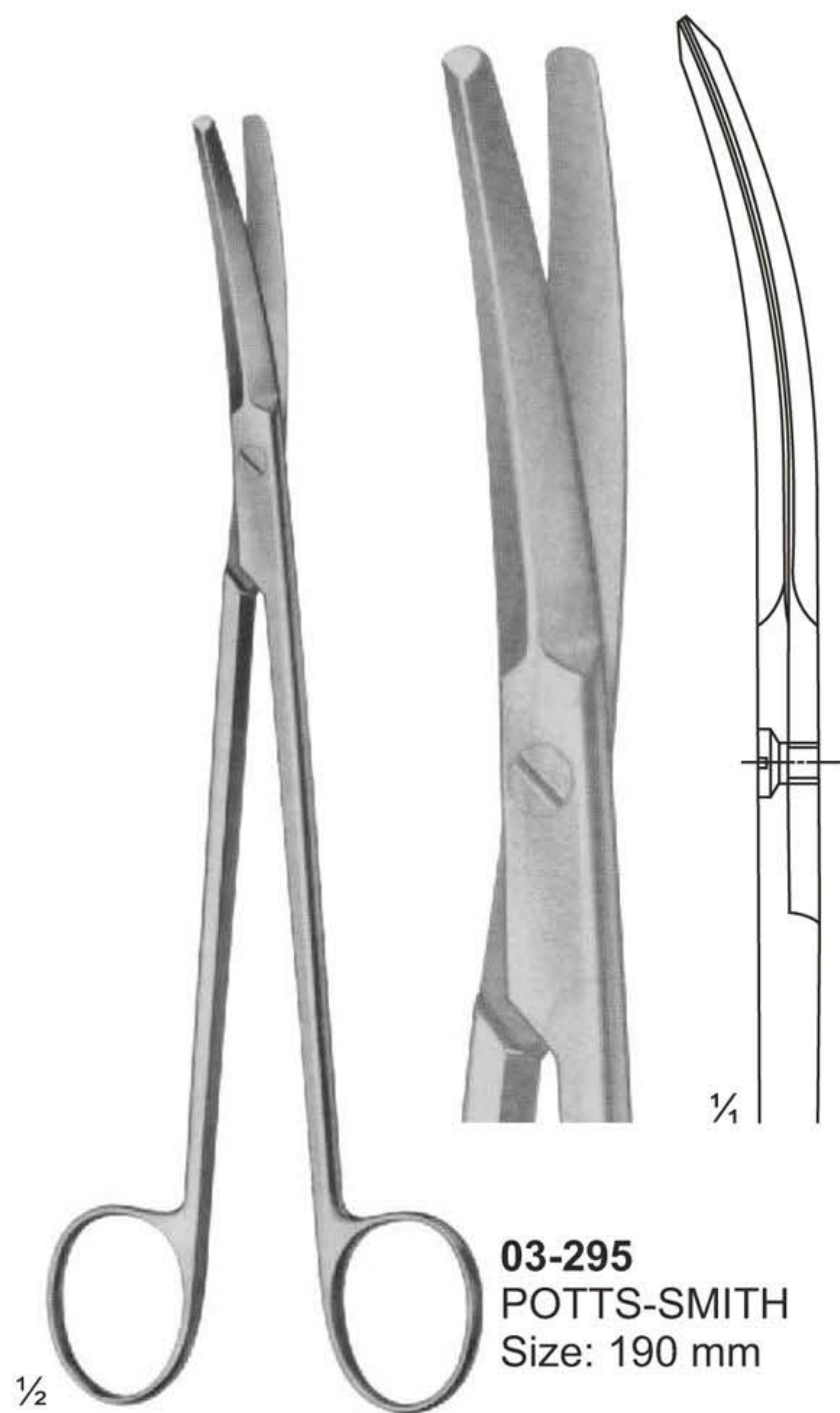

**03-295**  
POTTS-SMITH  
Size: 190 mm

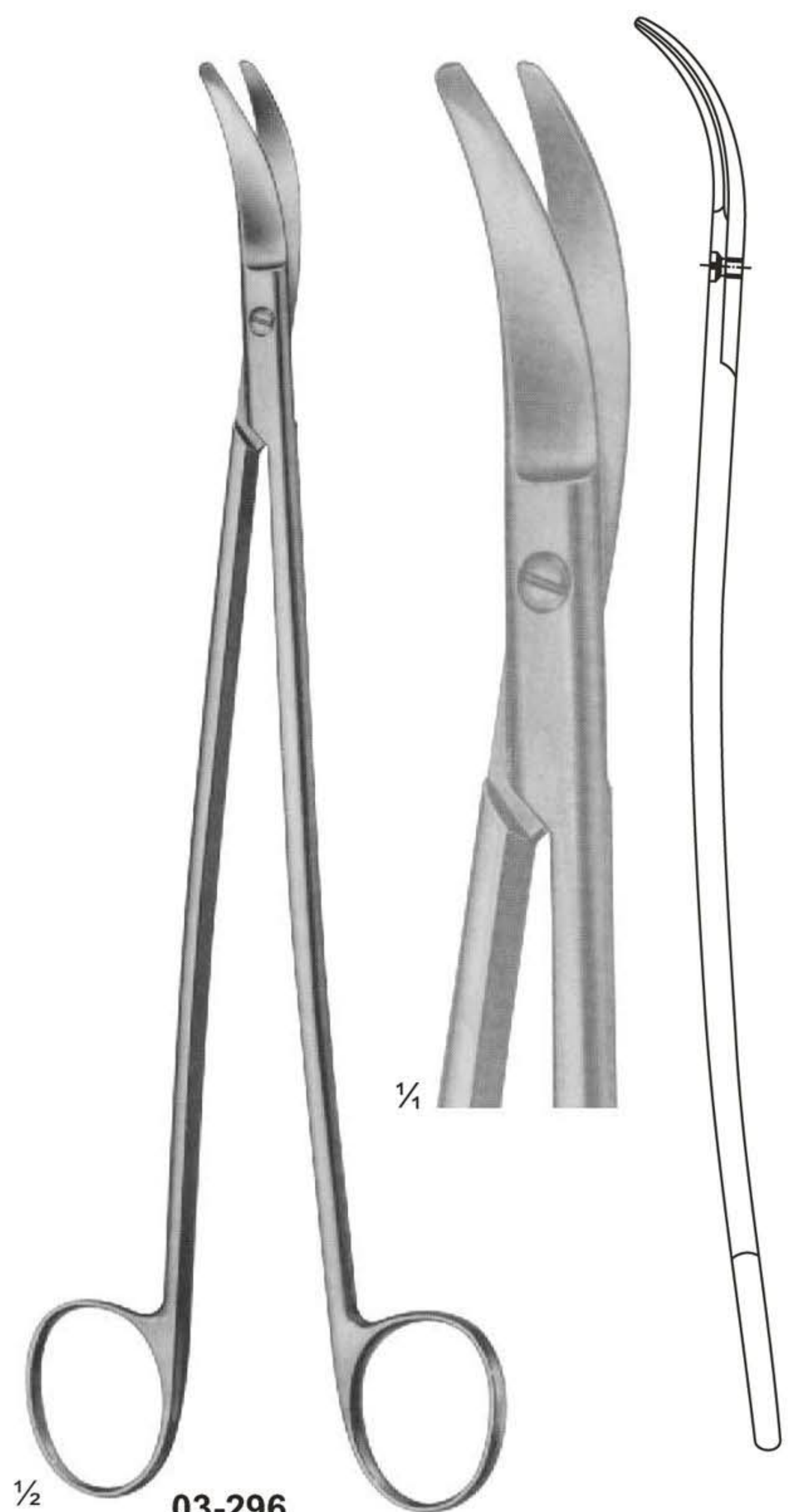

**03-296**  
SATINSKY  
Size: 245 mm



**Delicate, Nasal and Tonsil Scissors**

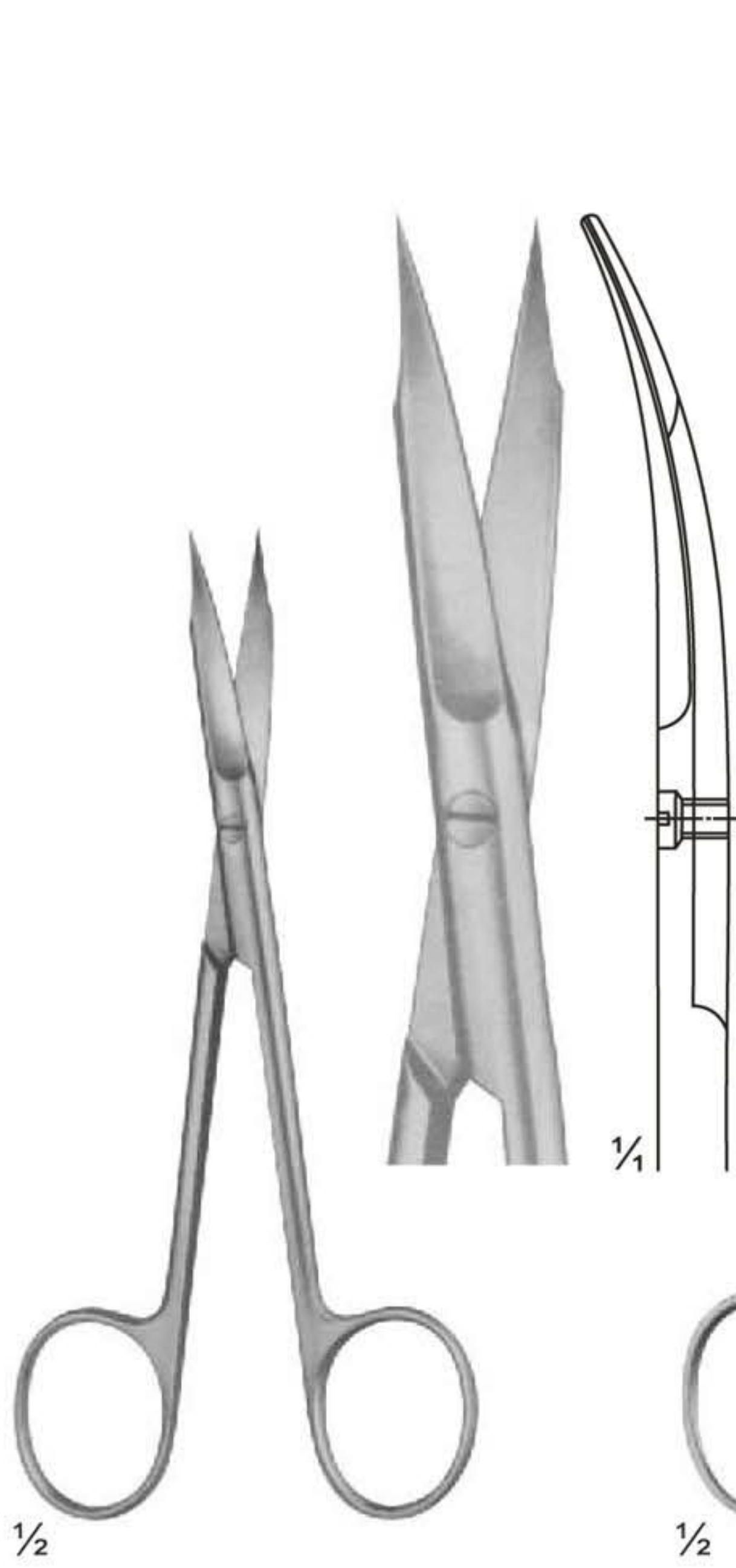

**03-297**  
1 Finely Toothed Blade  
Size: 130 mm

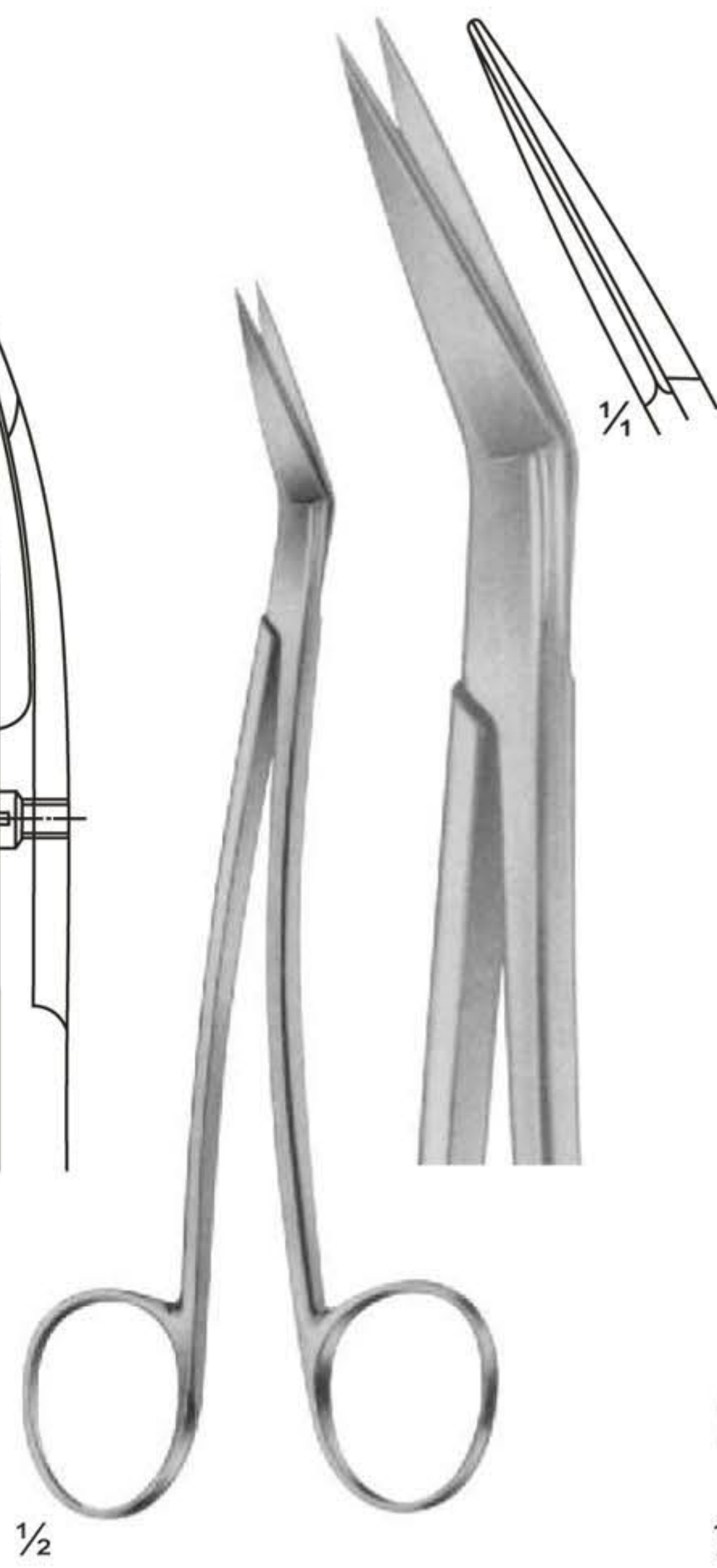

**03-298**  
LOCKLIN  
Curved Sideways,  
1 Toothed Blade  
Size: 155 mm

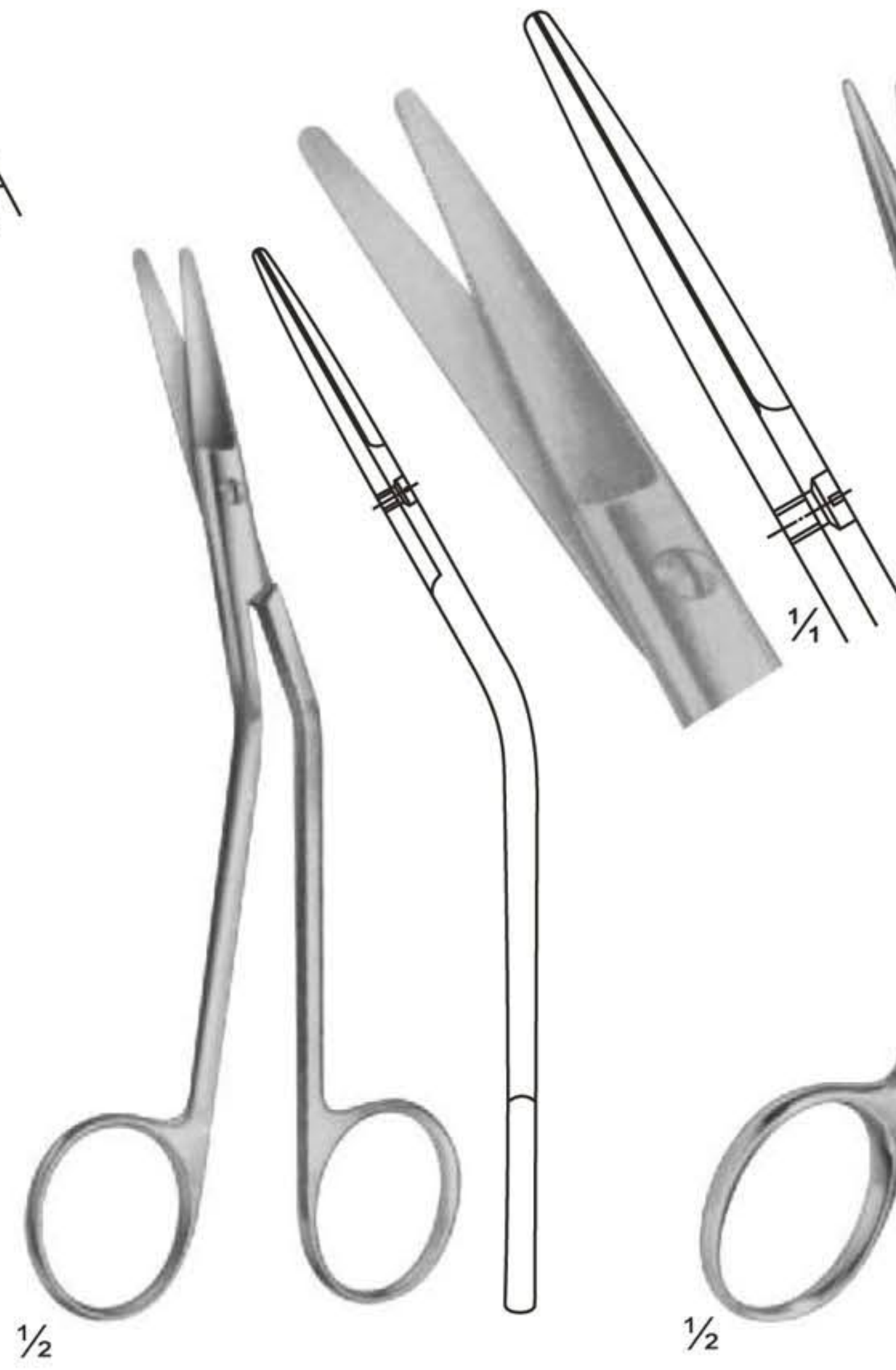

**03-299**  
FOMON  
Blades Serrated  
Size: 145 mm

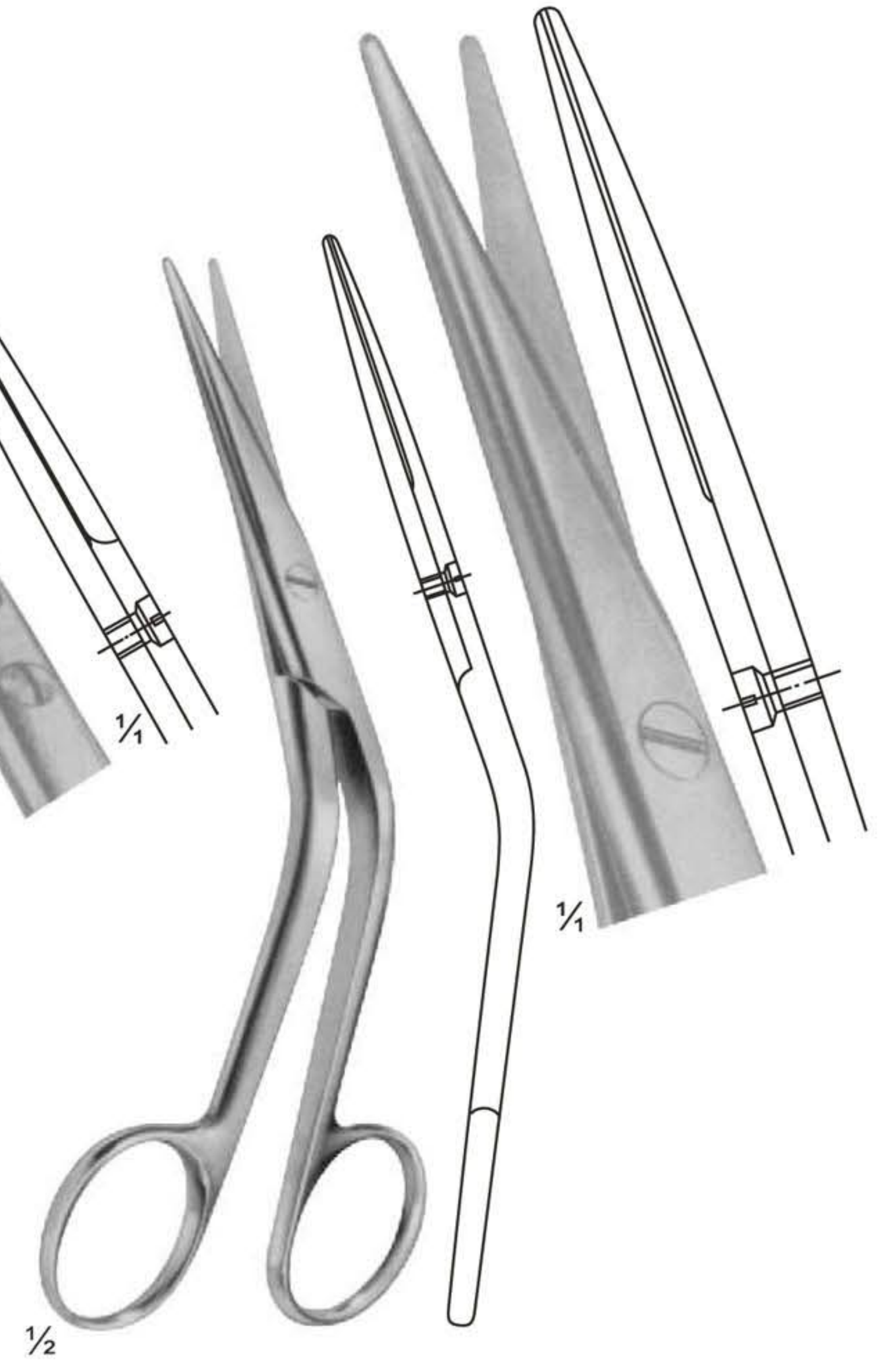

**03-300**  
COTTLE  
Size: 165 mm

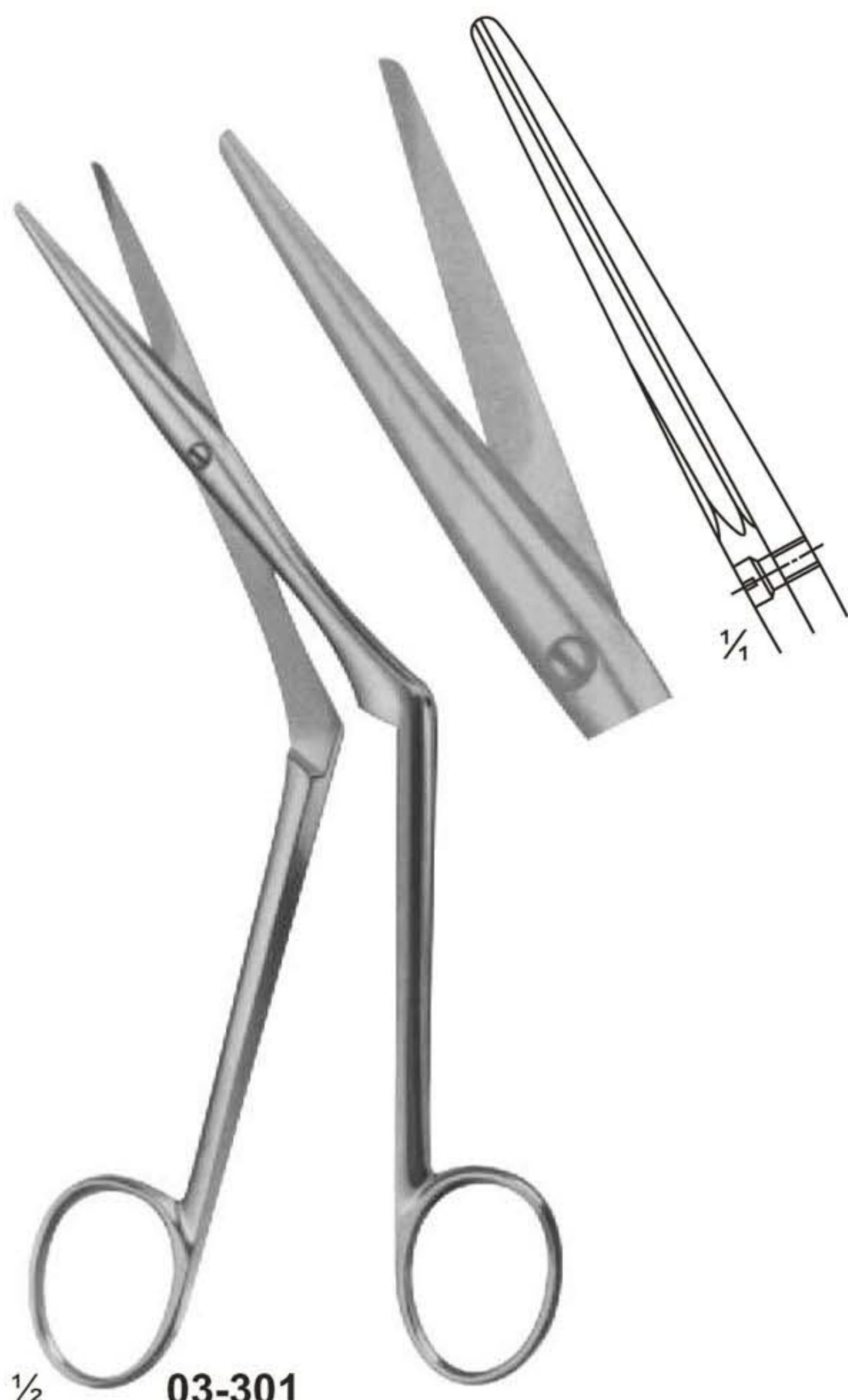

**03-301**  
HEYMANN-KNIGHT  
Size: 175 mm

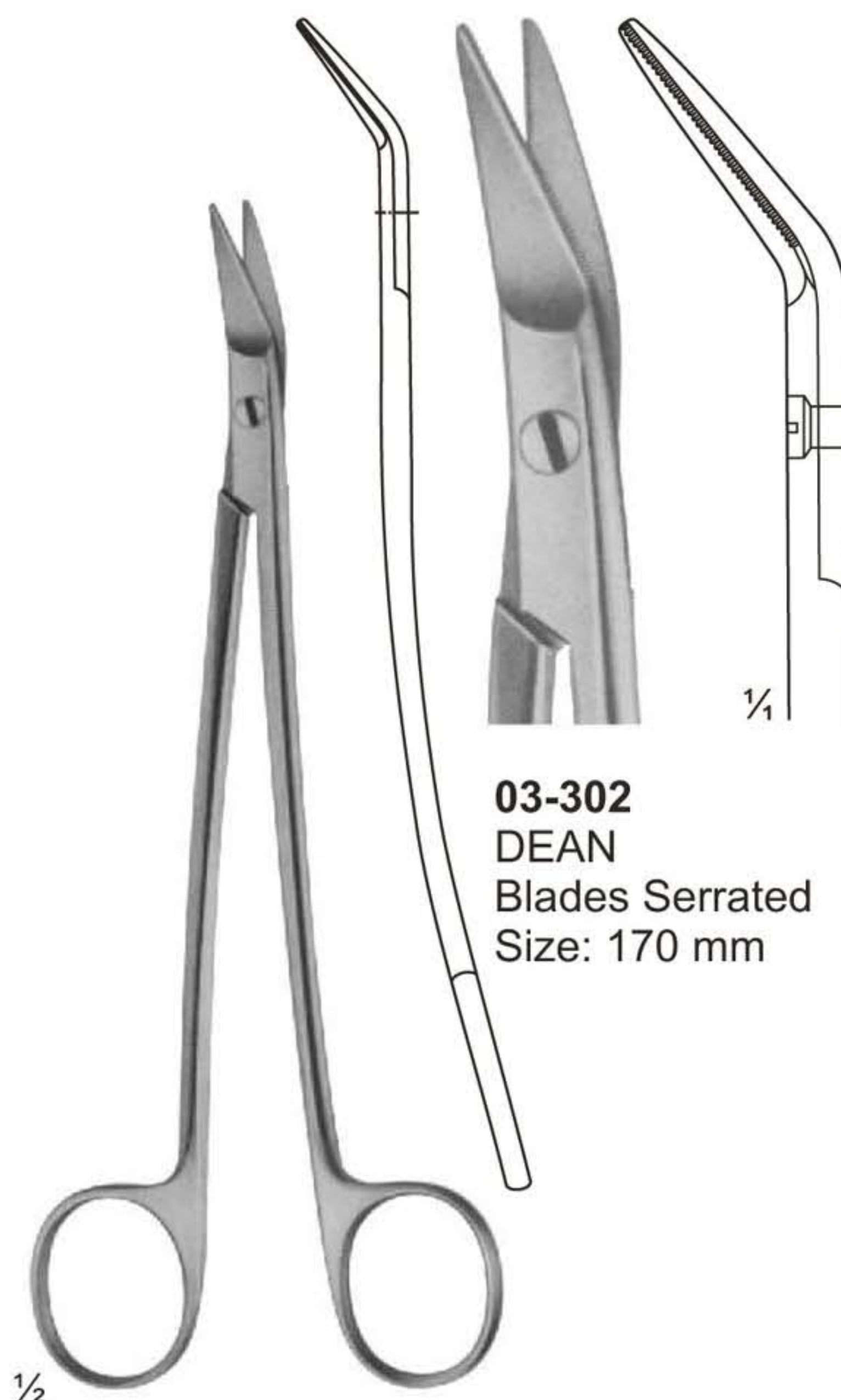

**03-302**  
DEAN  
Blades Serrated  
Size: 170 mm

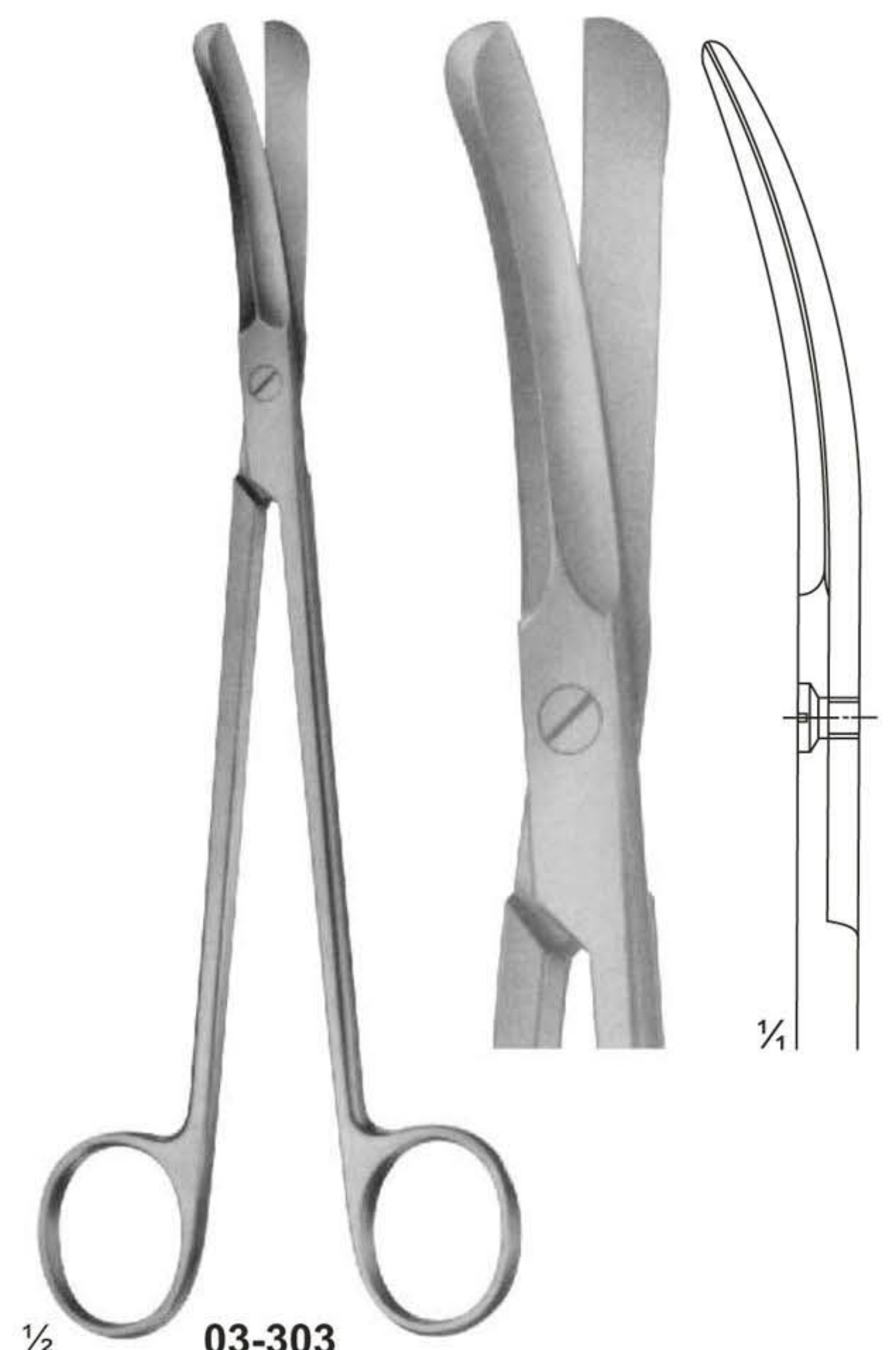

**03-303**  
GOOD  
Size: 195 mm



**Bone Shears**

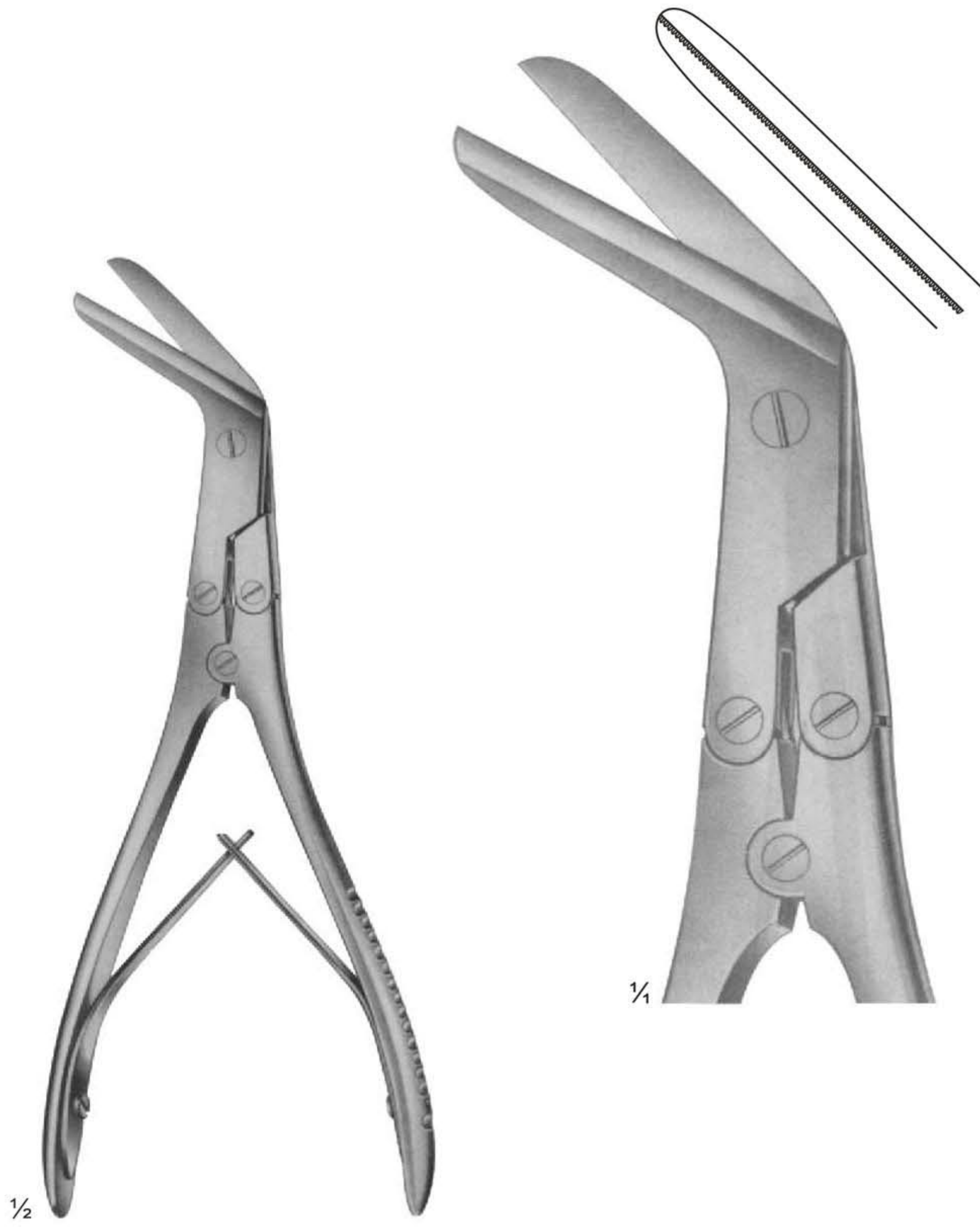

**03-304**  
KILLIAN  
Size: 200 mm

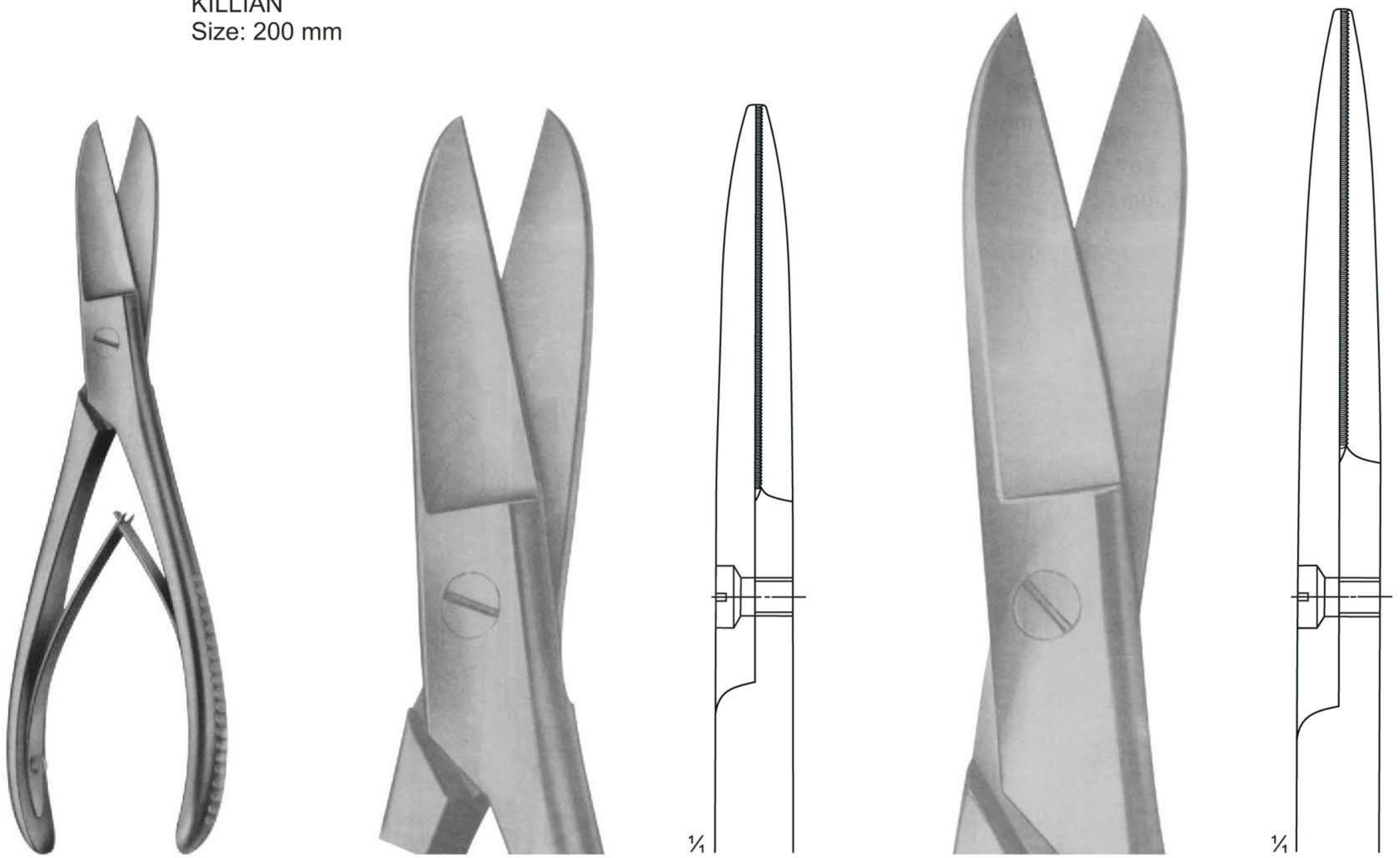

**03-305 - 306**

**03-305**  
195 mm

**03-306**  
225 mm



Operating and Gynaecology Scissors

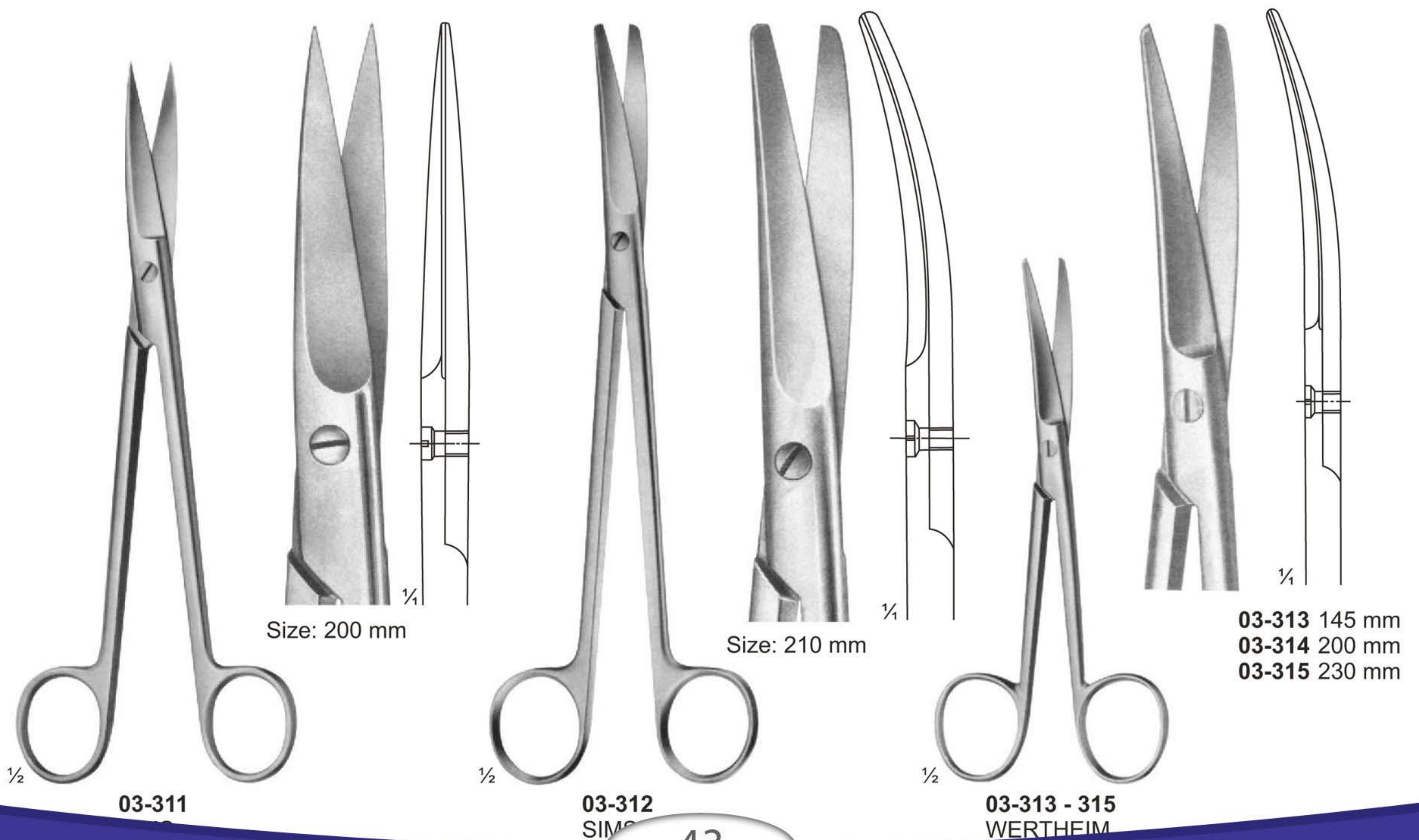
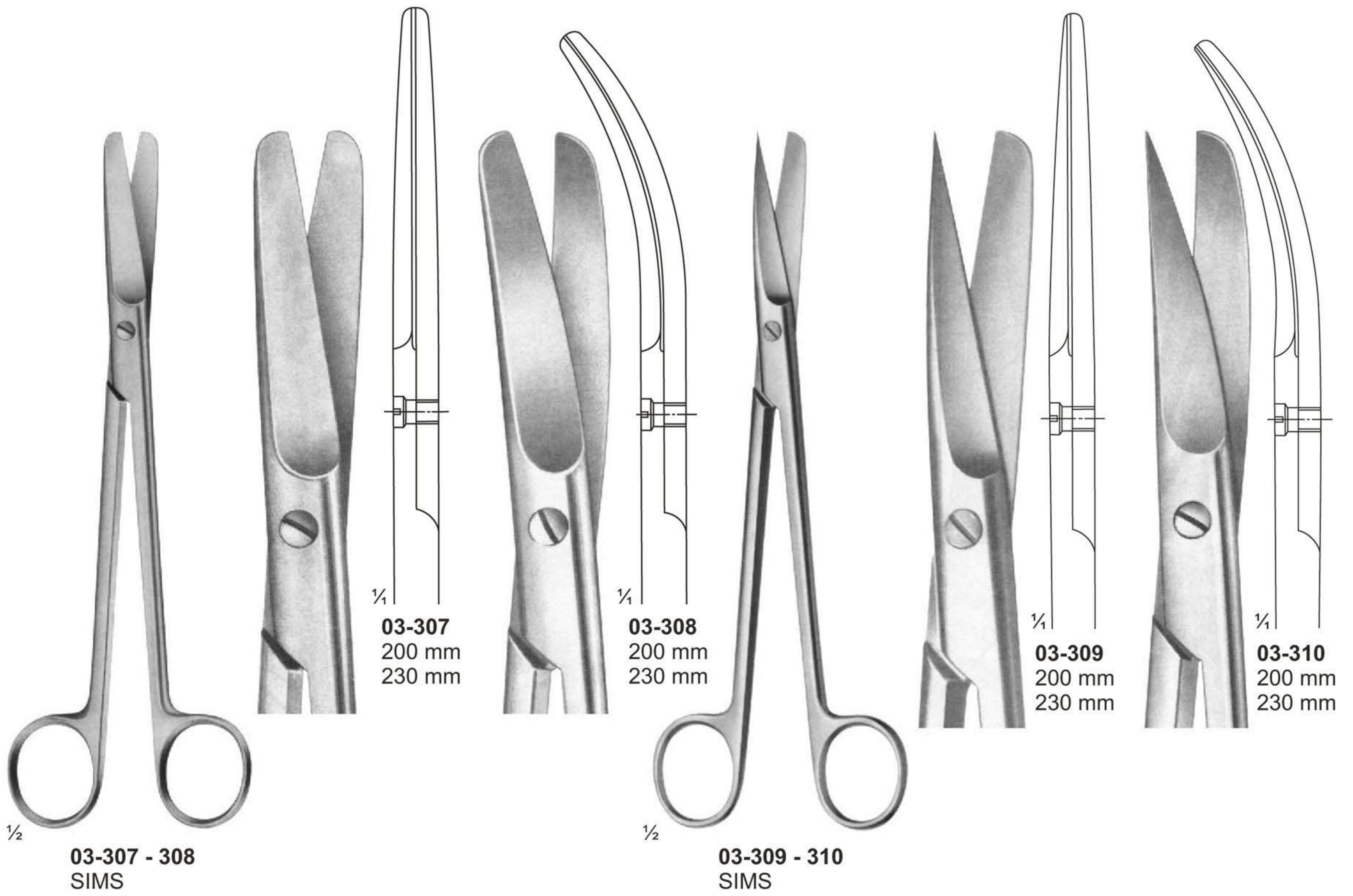



## Operating and Gynaecology Scissors

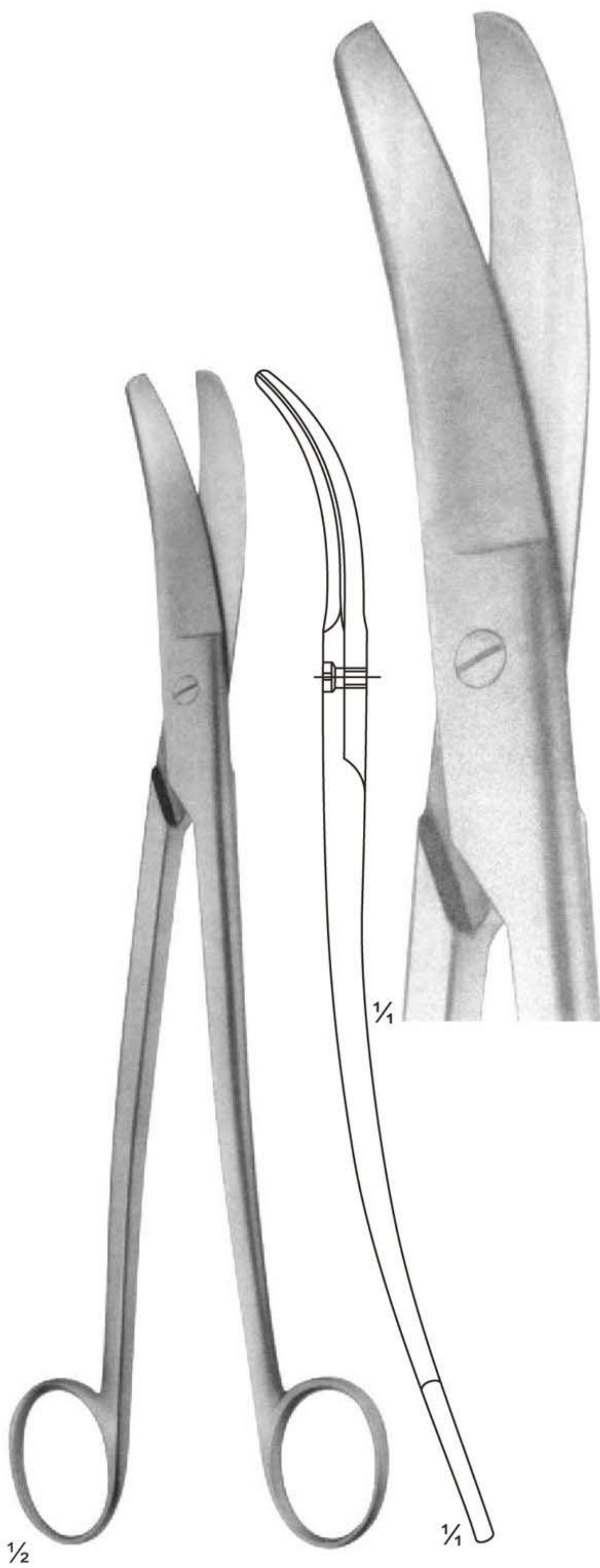

**03-316**  
SIEBOLD  
Uterine Scissors  
Size: 245 mm

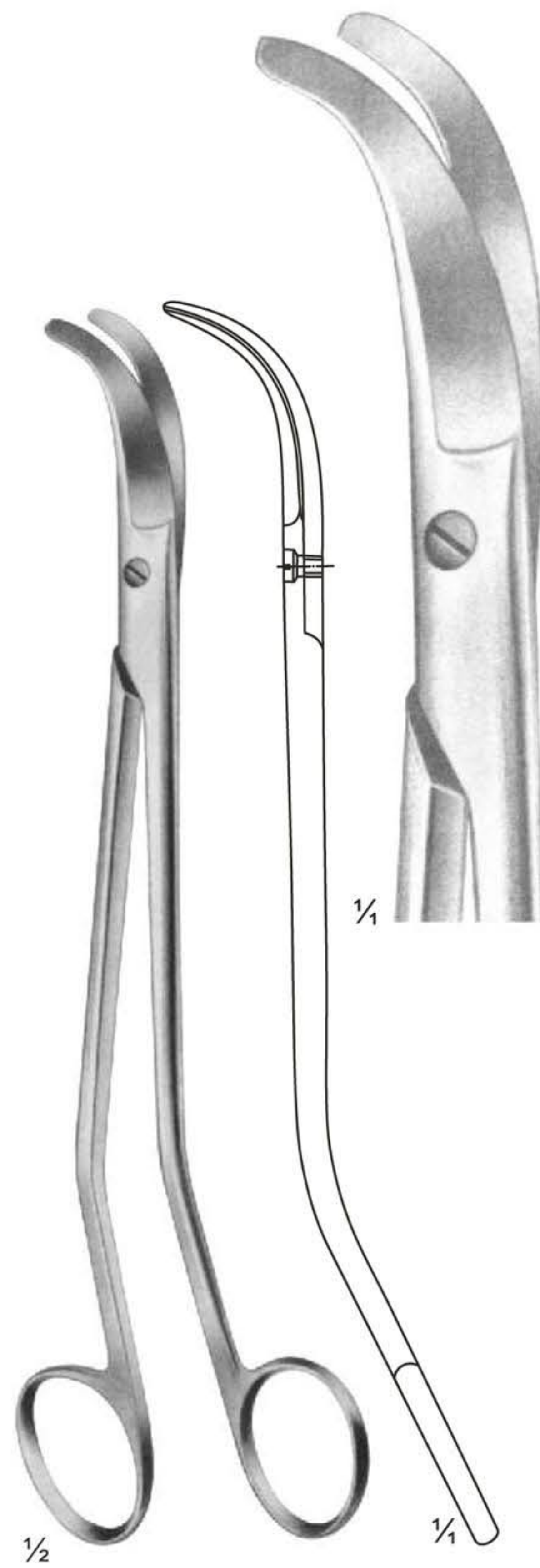

**03-317**  
BOZEMANN  
Uterine Scissors  
Size: 220 mm

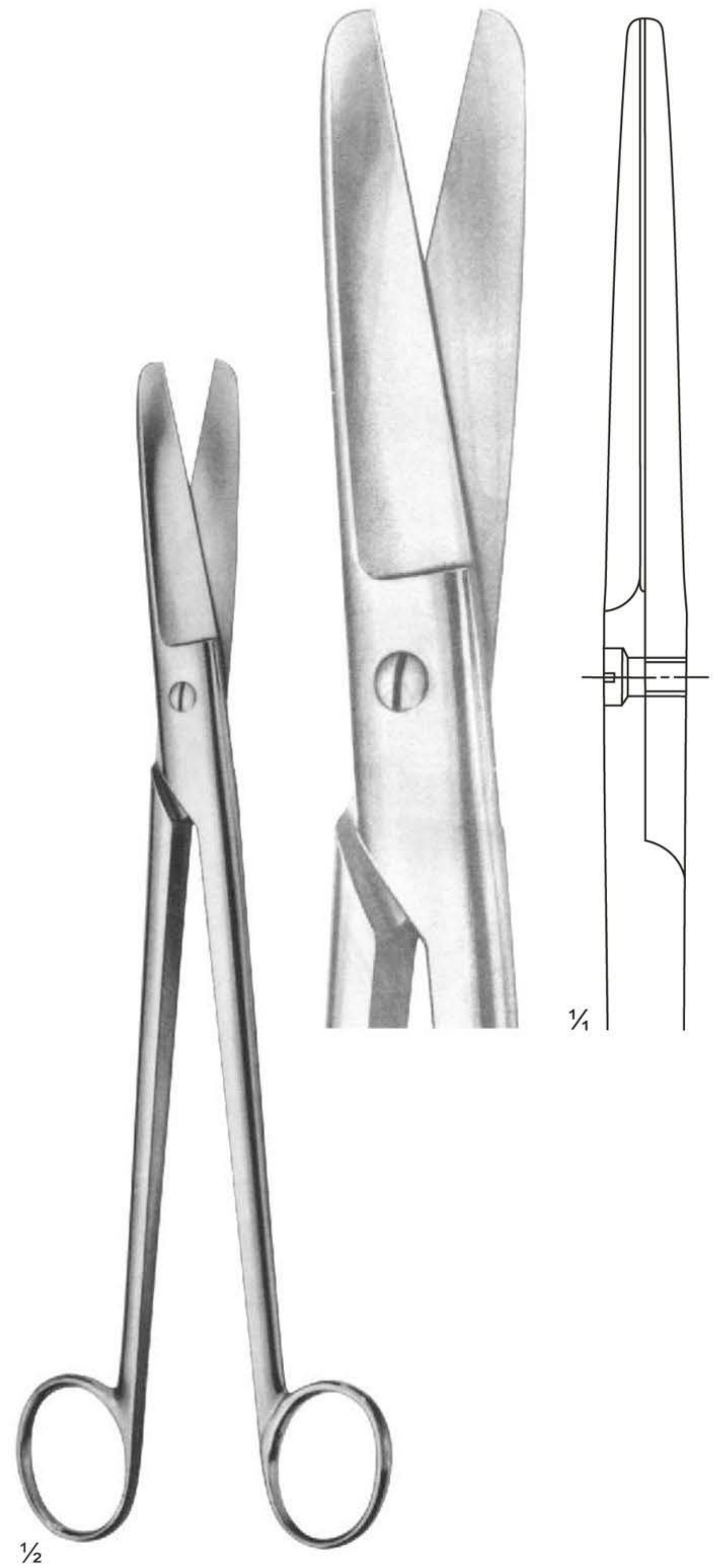

**03-318**  
SIMS-SIEBOLD  
Uterine Scissors  
Size: 250 mm



Operating and Gynaecology Scissors

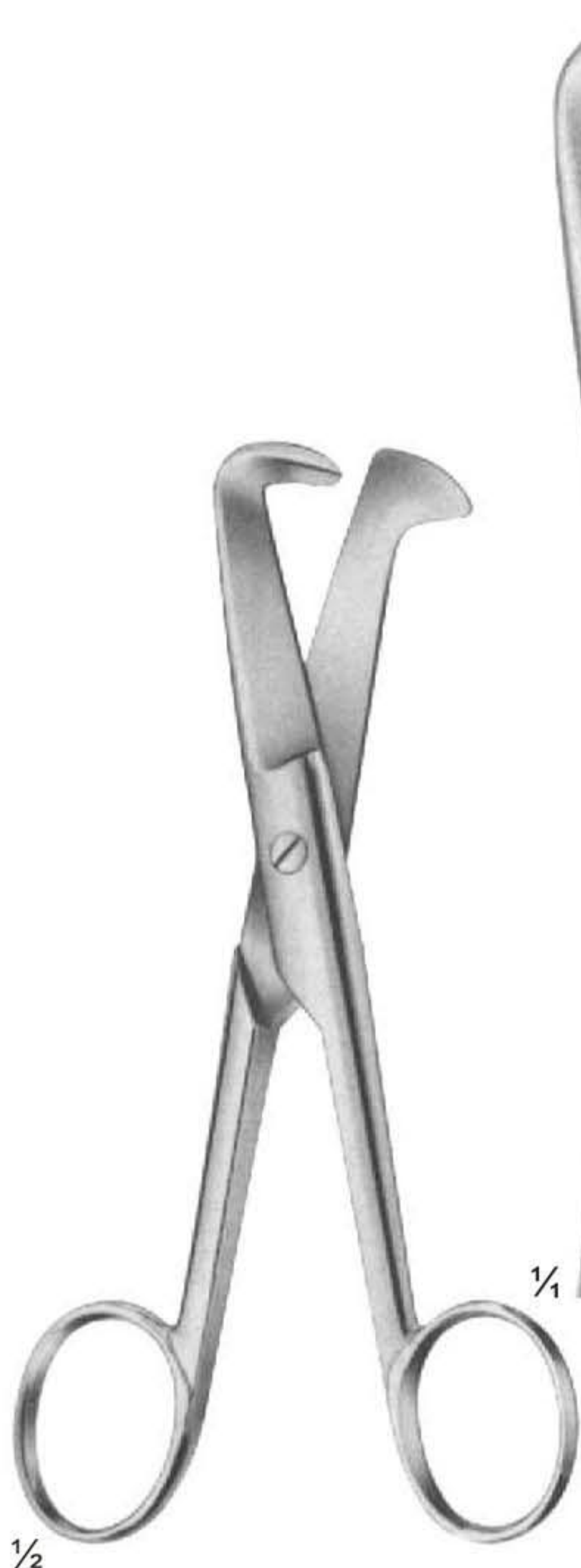

**03-319**  
SCHUMACHER  
Umbilical Cord Scissors  
Size: 155 mm



**03-320**  
Umbilical Cord Scissors  
Size: 105 mm



**03-321**  
Umbilical Cord Scissors

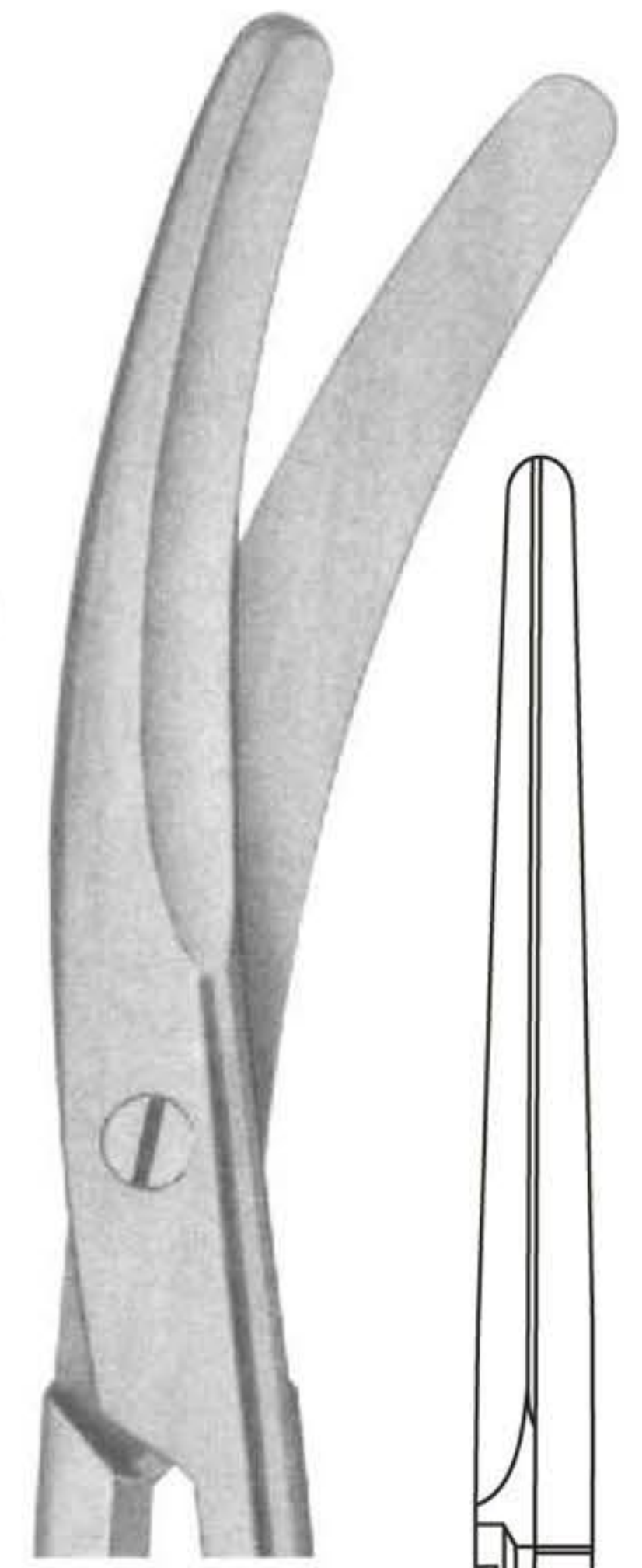

1/4  
135 mm



**03-322 - 323**  
BRAUN-STADLER  
Empisiotomy Scissors

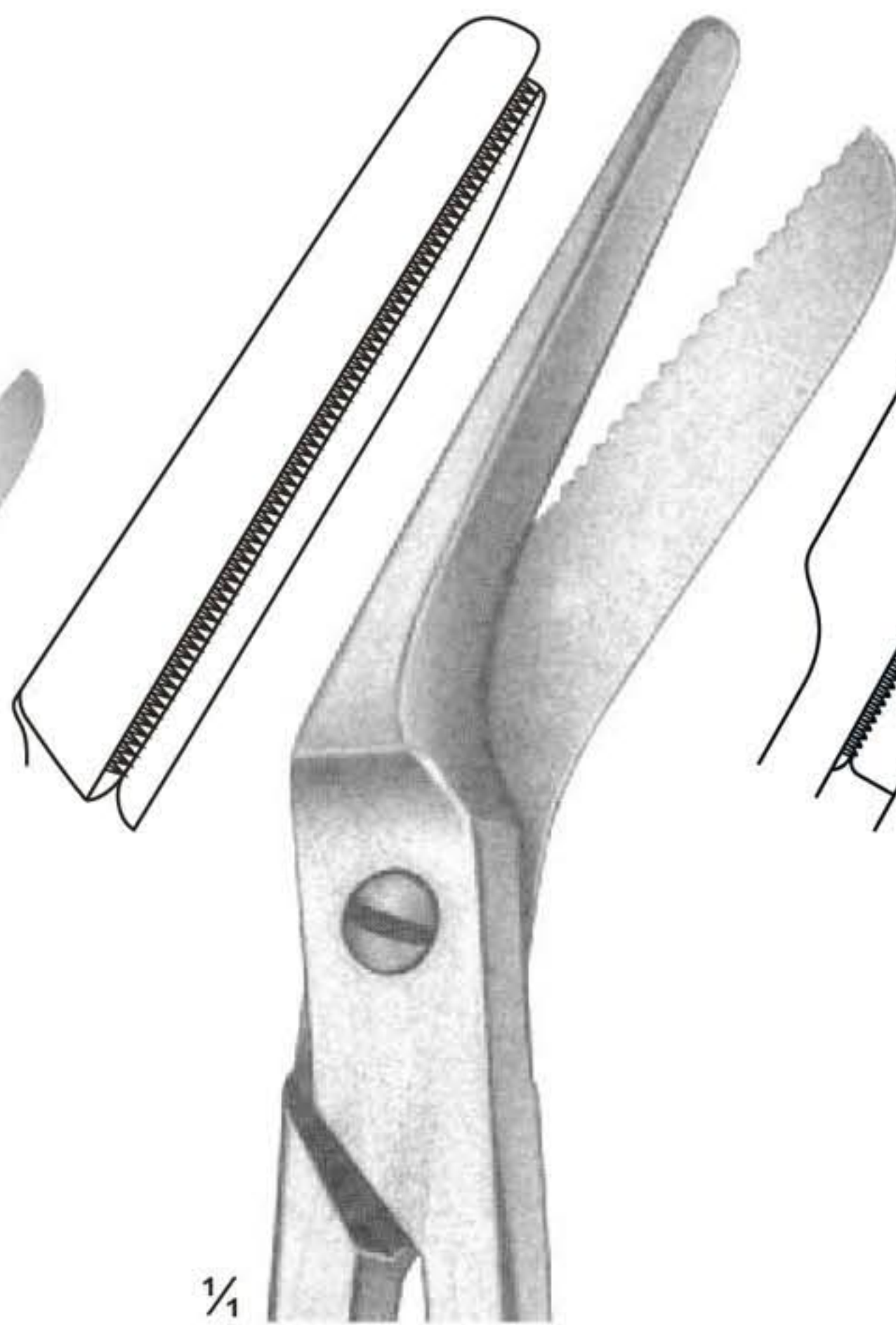

**03-322**  
145 mm

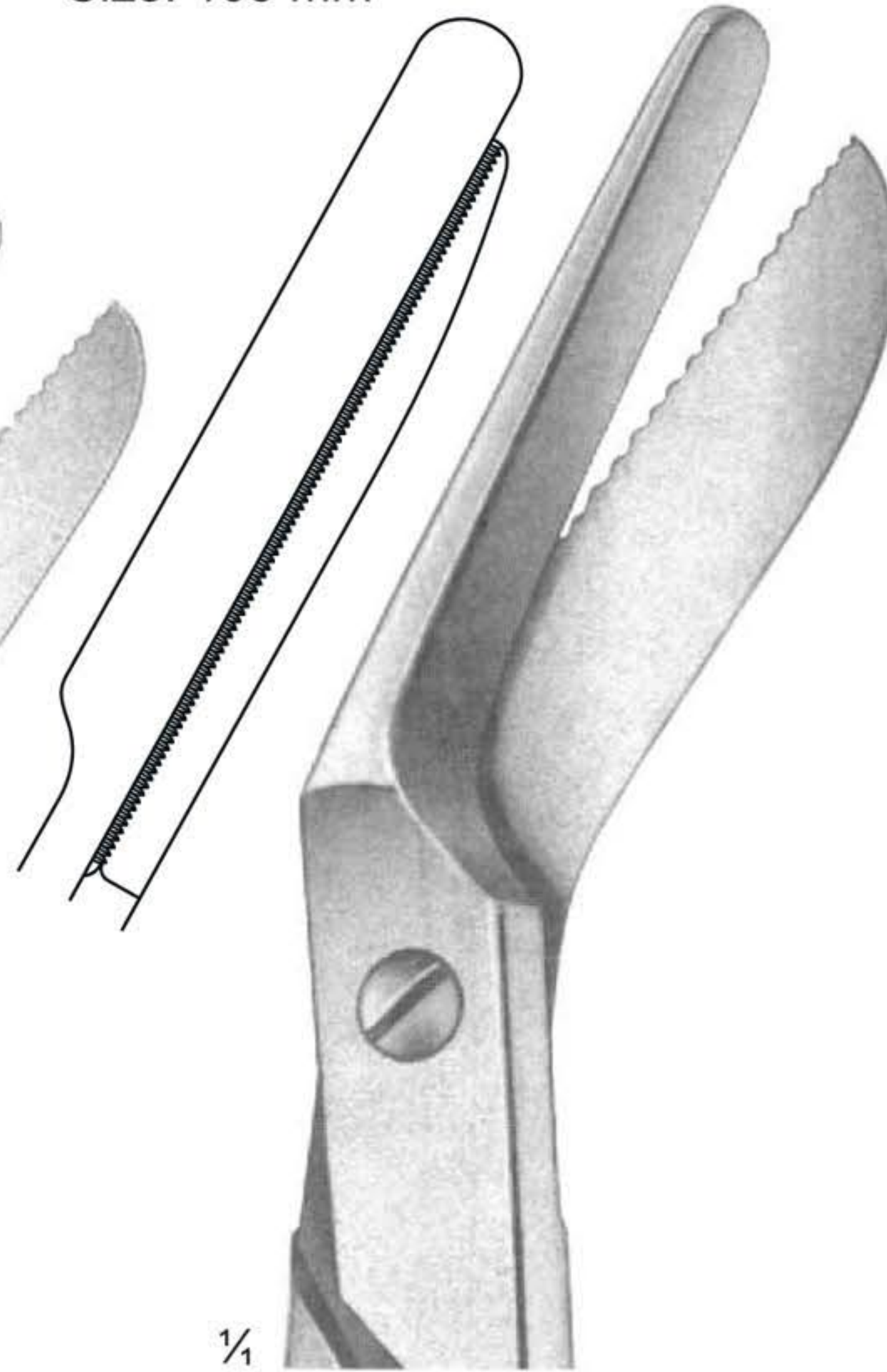

**03-323**  
200 mm

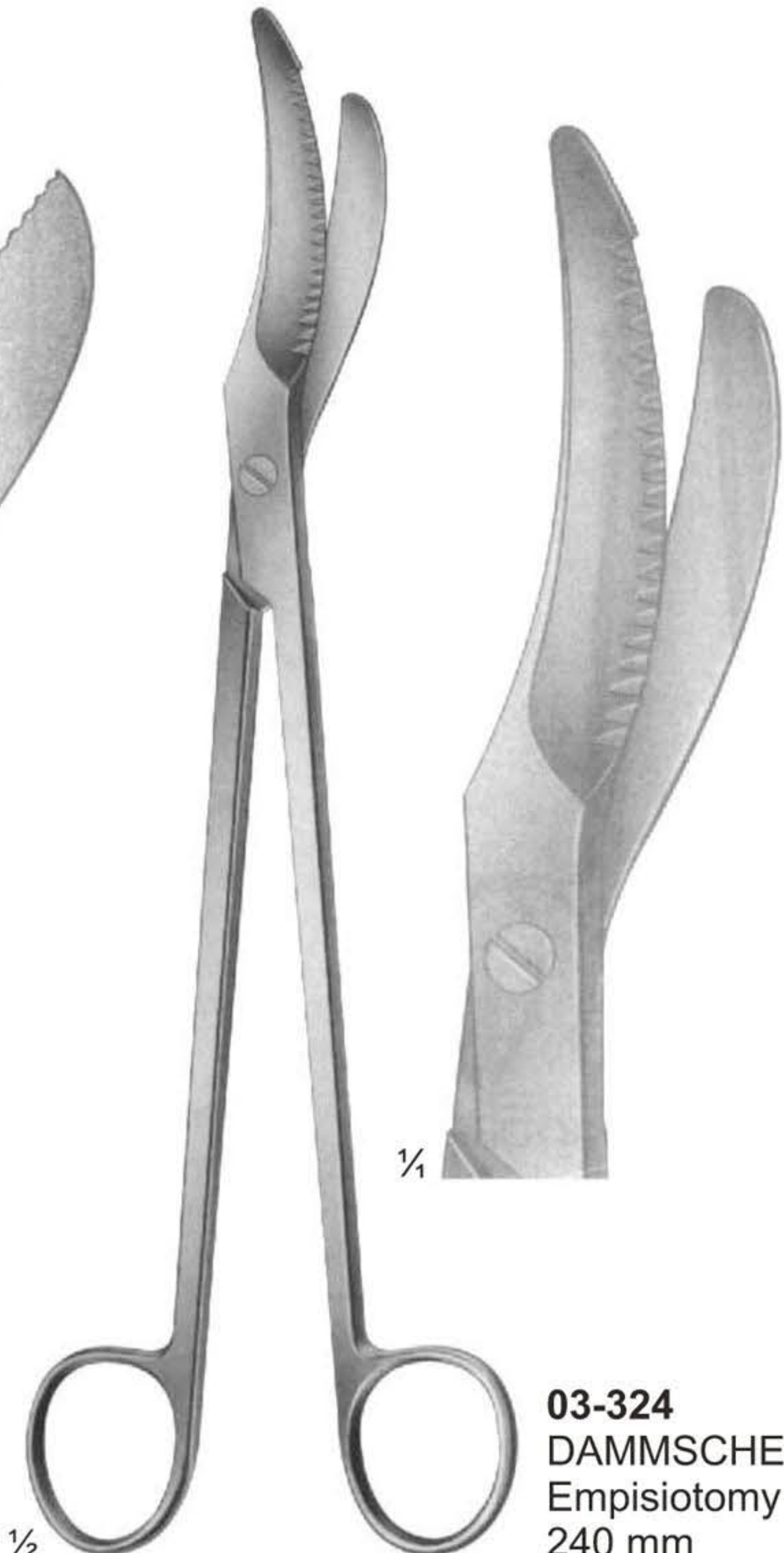

**03-324**  
DAMMSCHERE  
Empisiotomy Scissors  
240 mm

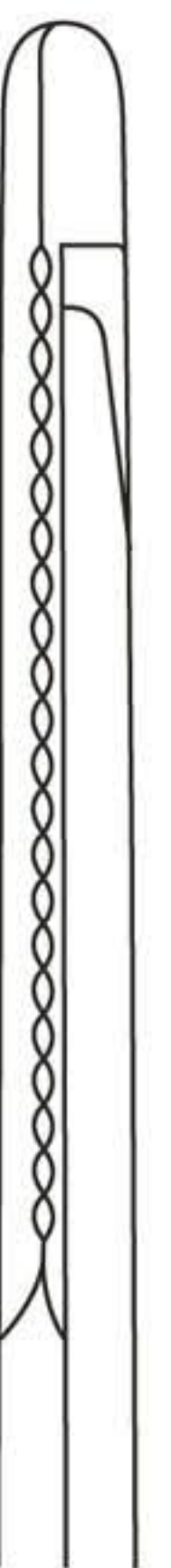



**Bowel Scissors, Cartilage Scissors**

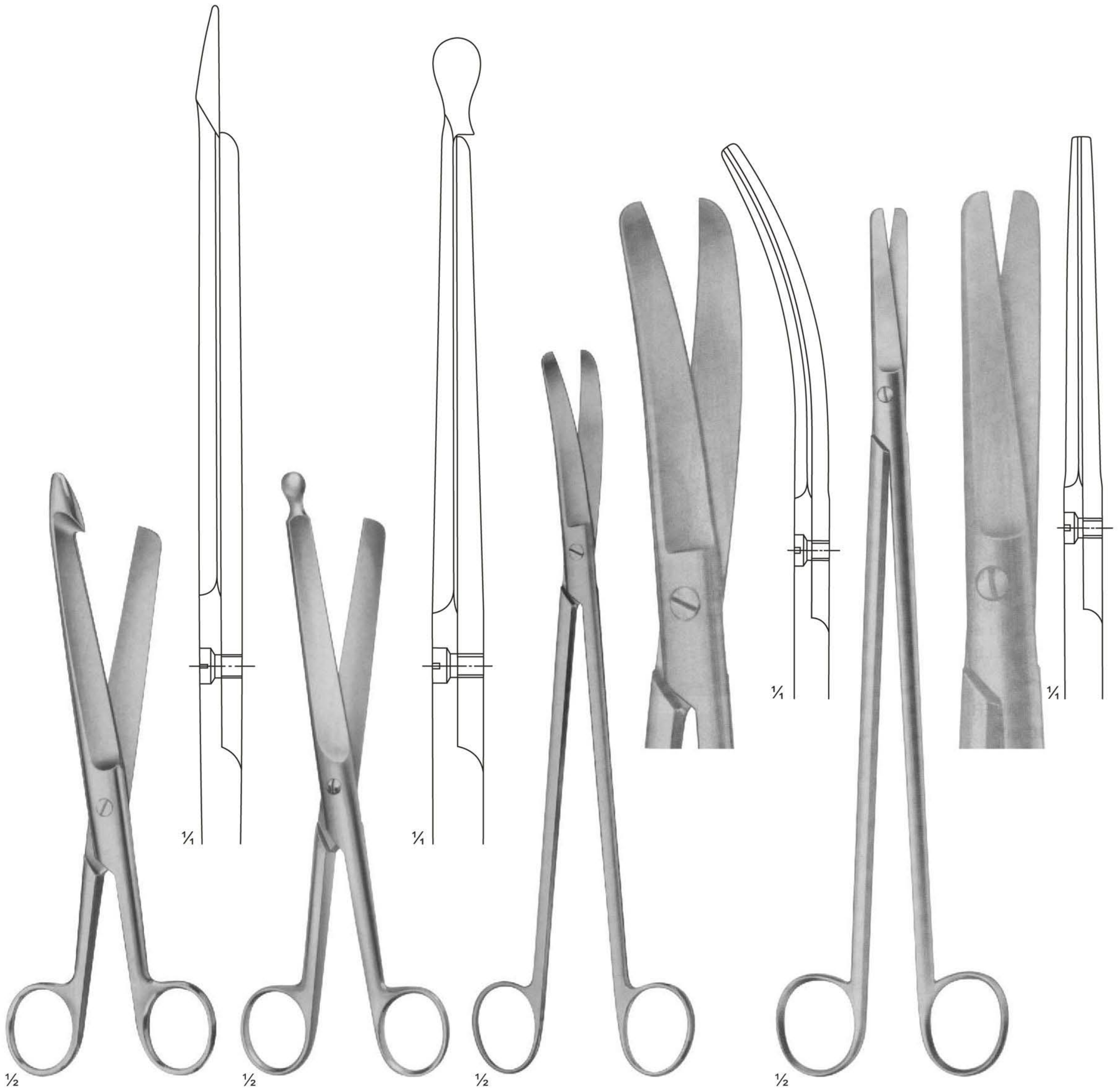

**03-325**  
DAMMSCHERE  
Bowel Scissors  
Size: 210 mm

**03-326**  
DAMMSCHERE  
Bowel Scissors  
Size: 210 mm

**03-327**  
LLOYD-DAVIES  
(GOLIGHER'S)  
Rectal Scissors  
Size: 255 mm

**03-328**  
STELZNER  
Rectal Scissors  
Size: 310 mm



# Ligature Scissors

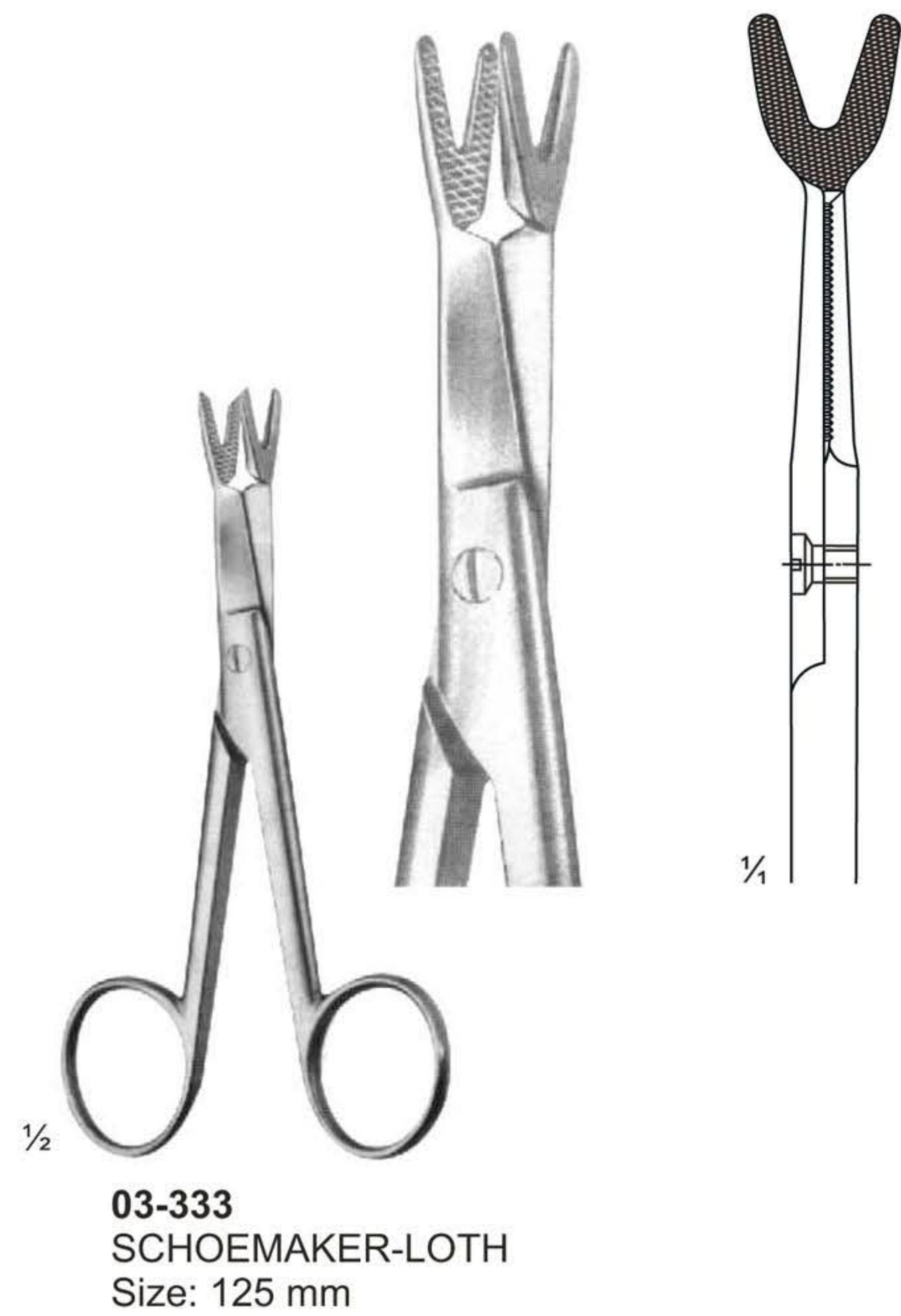
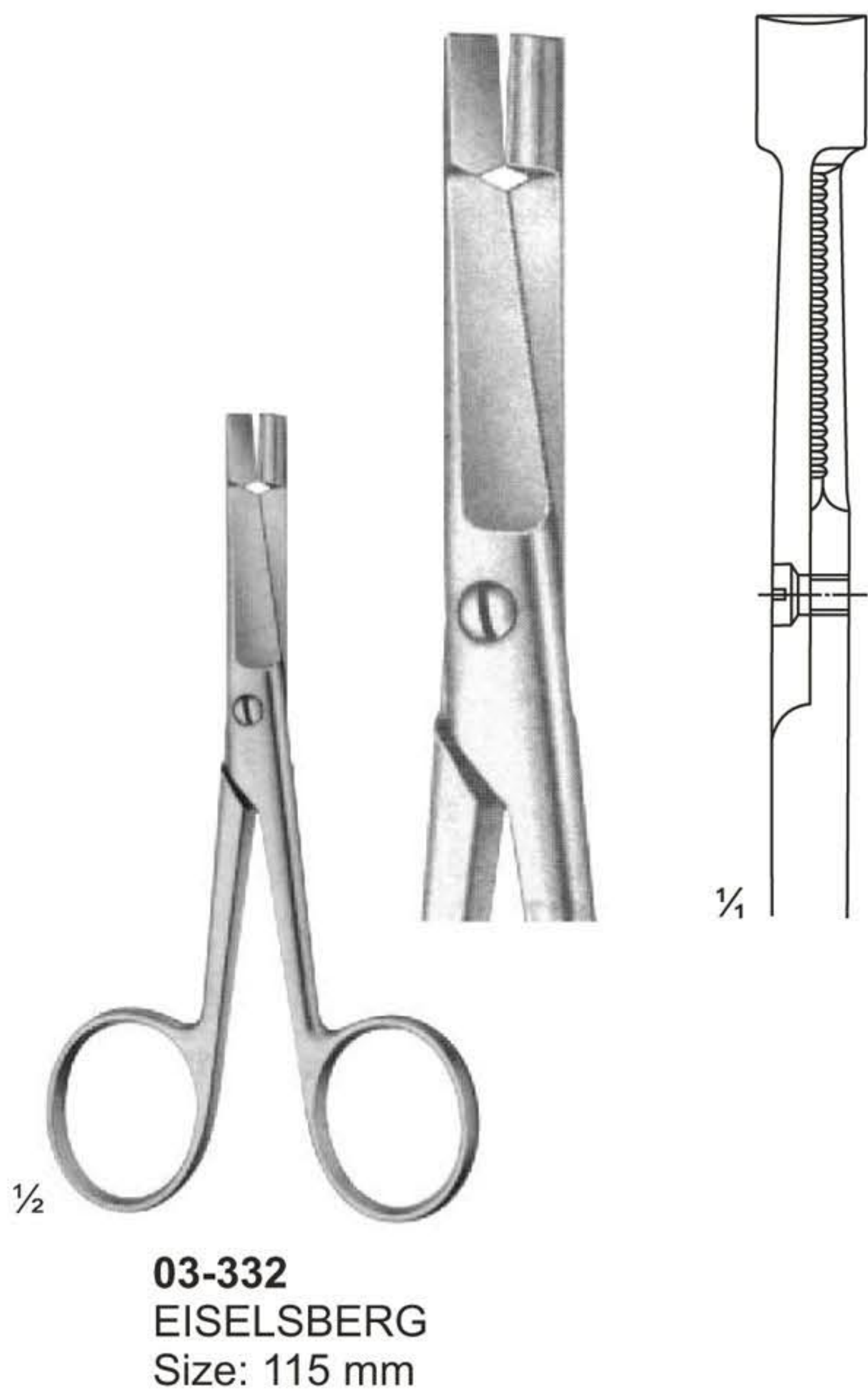
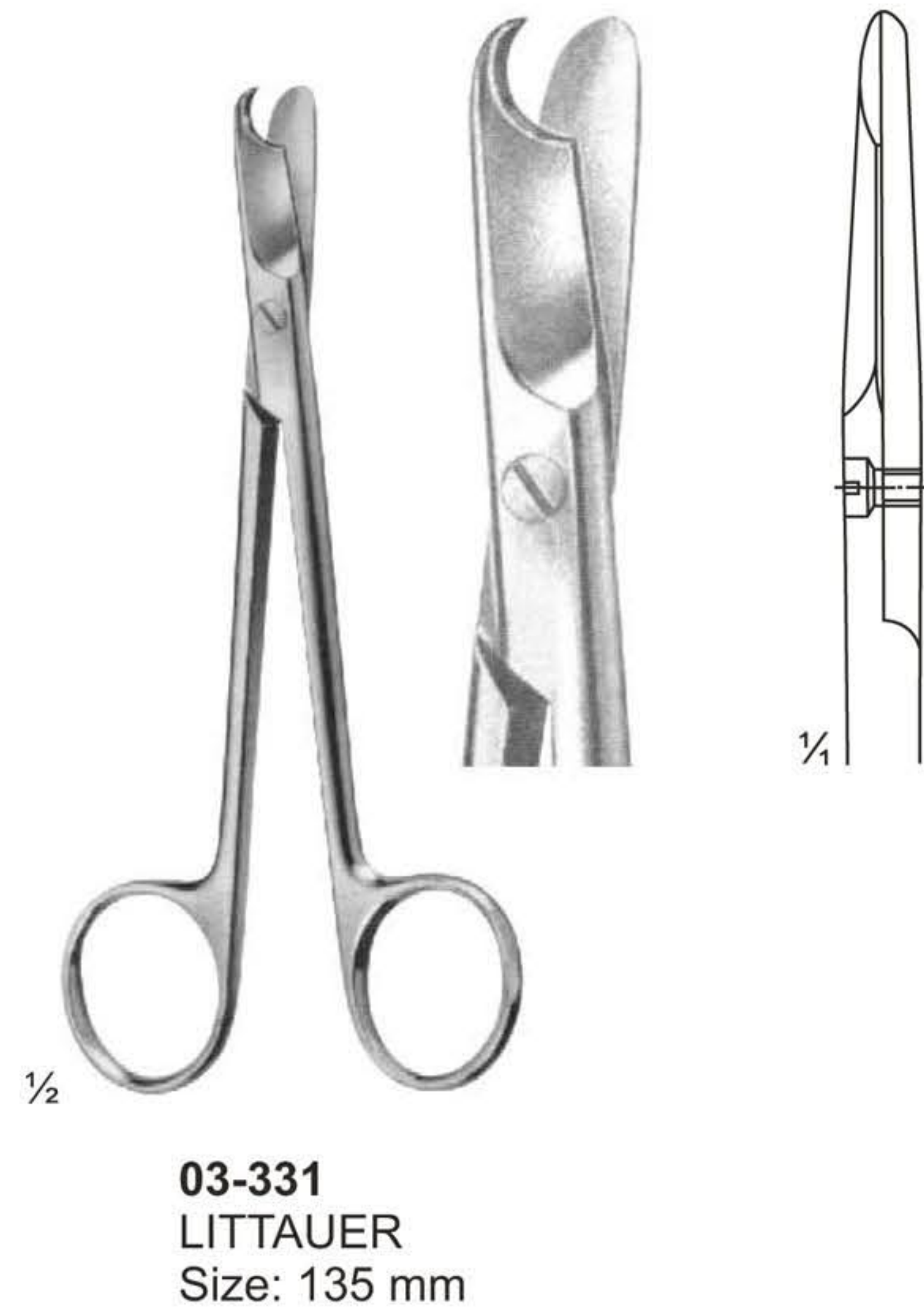
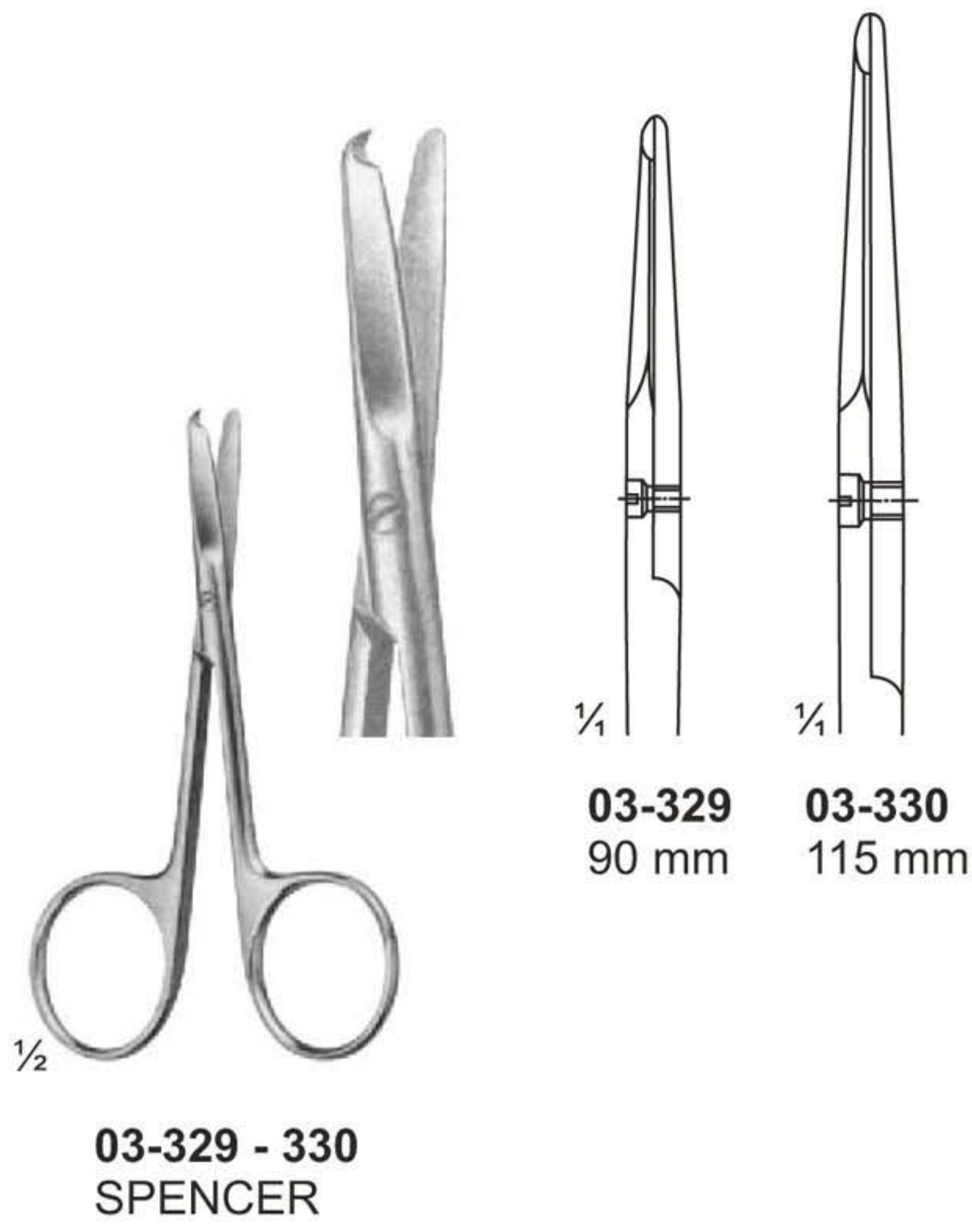



Wire and Plate Scissors



1/2

**03-334 - 338**  
BEEBE  
Size: 110 mm

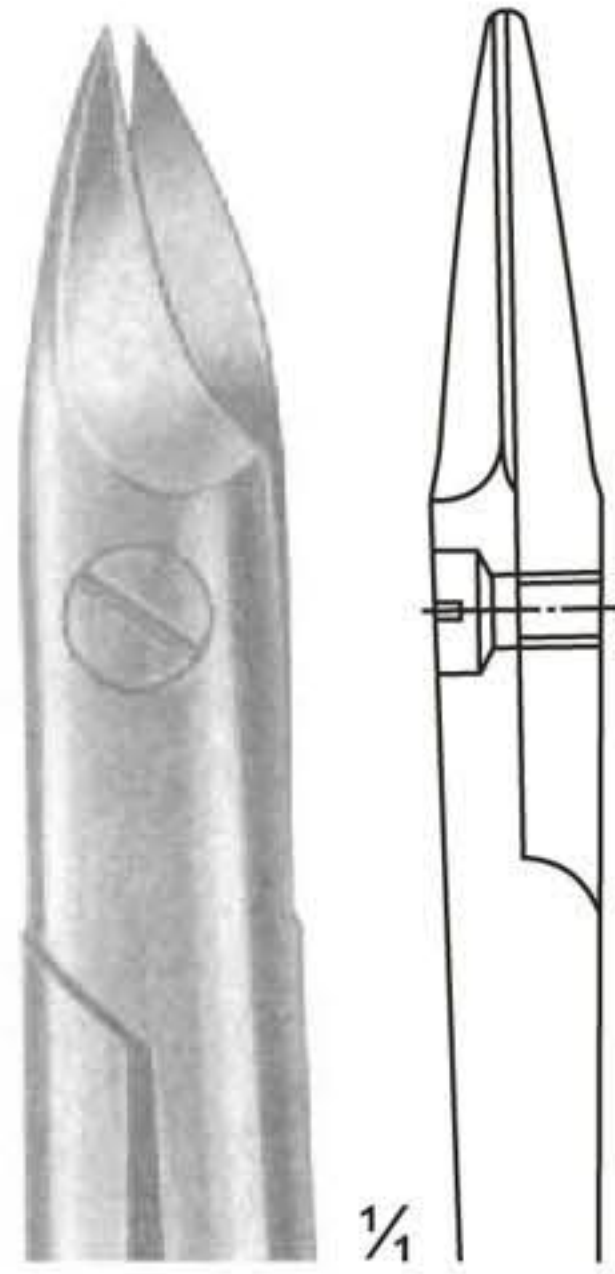

1/4

**03-334**

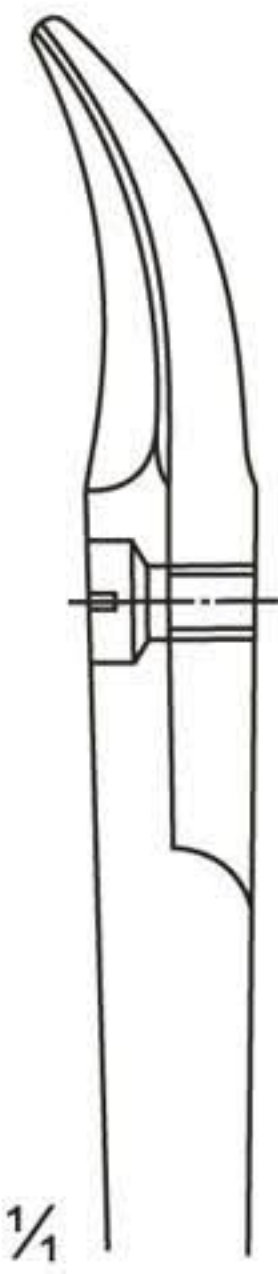

1/4

**03-335**

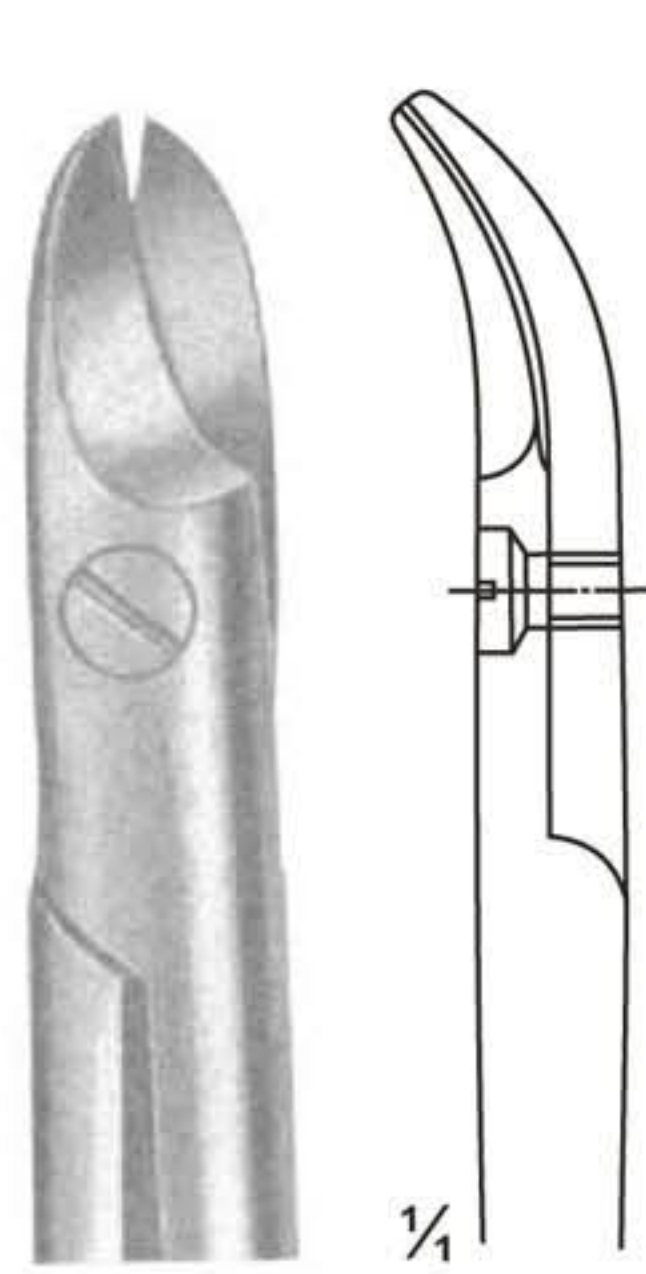

1/4

**03-336**  
Broad Blades

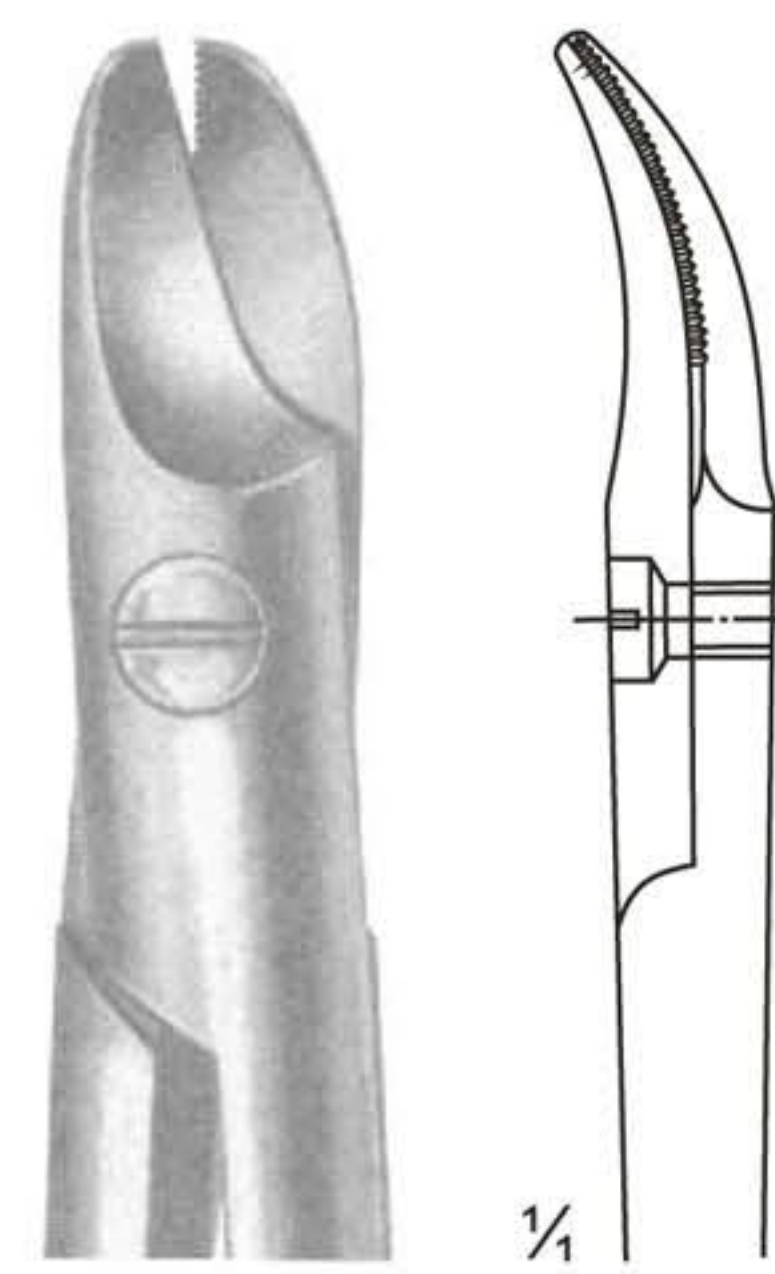

1/4

**03-337**  
1 Blade Serrated

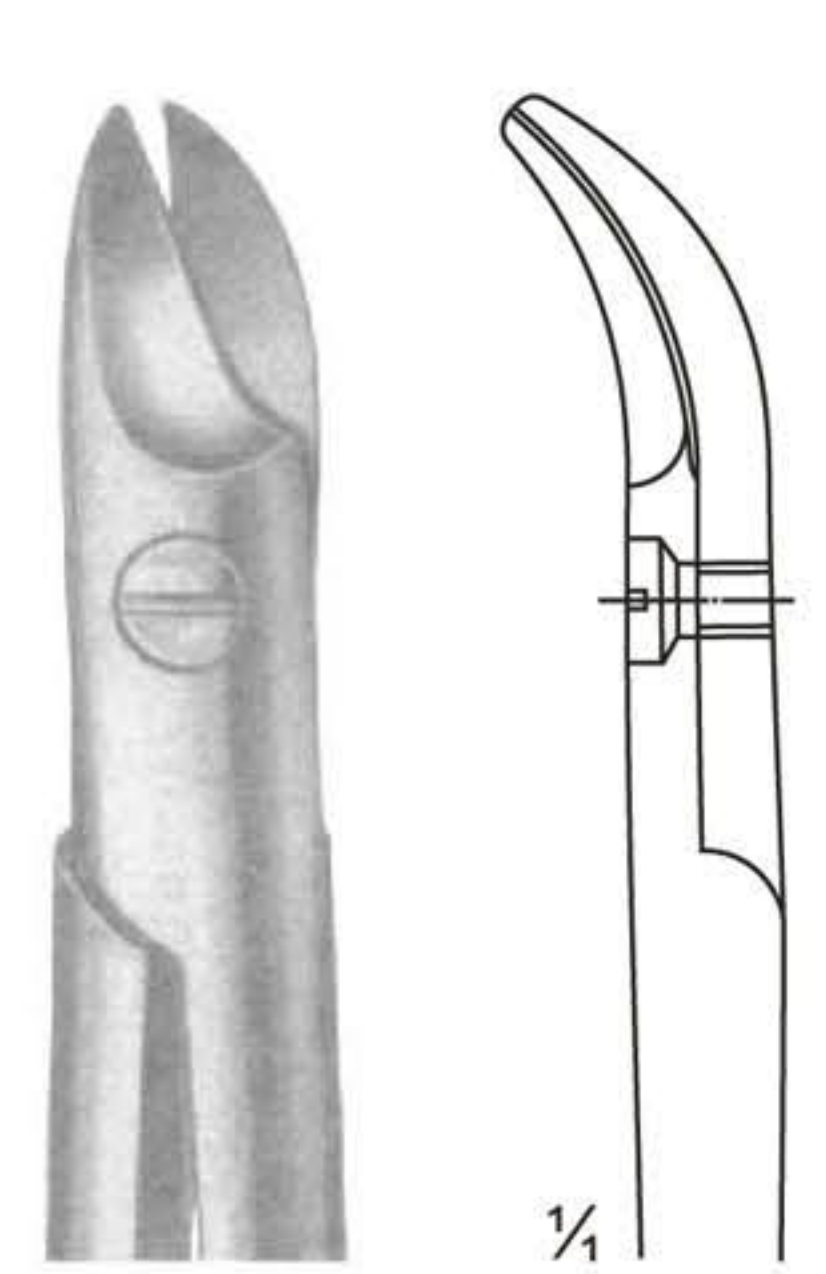

1/4

**03-338**  
NAUJOKS  
Strongly Curved

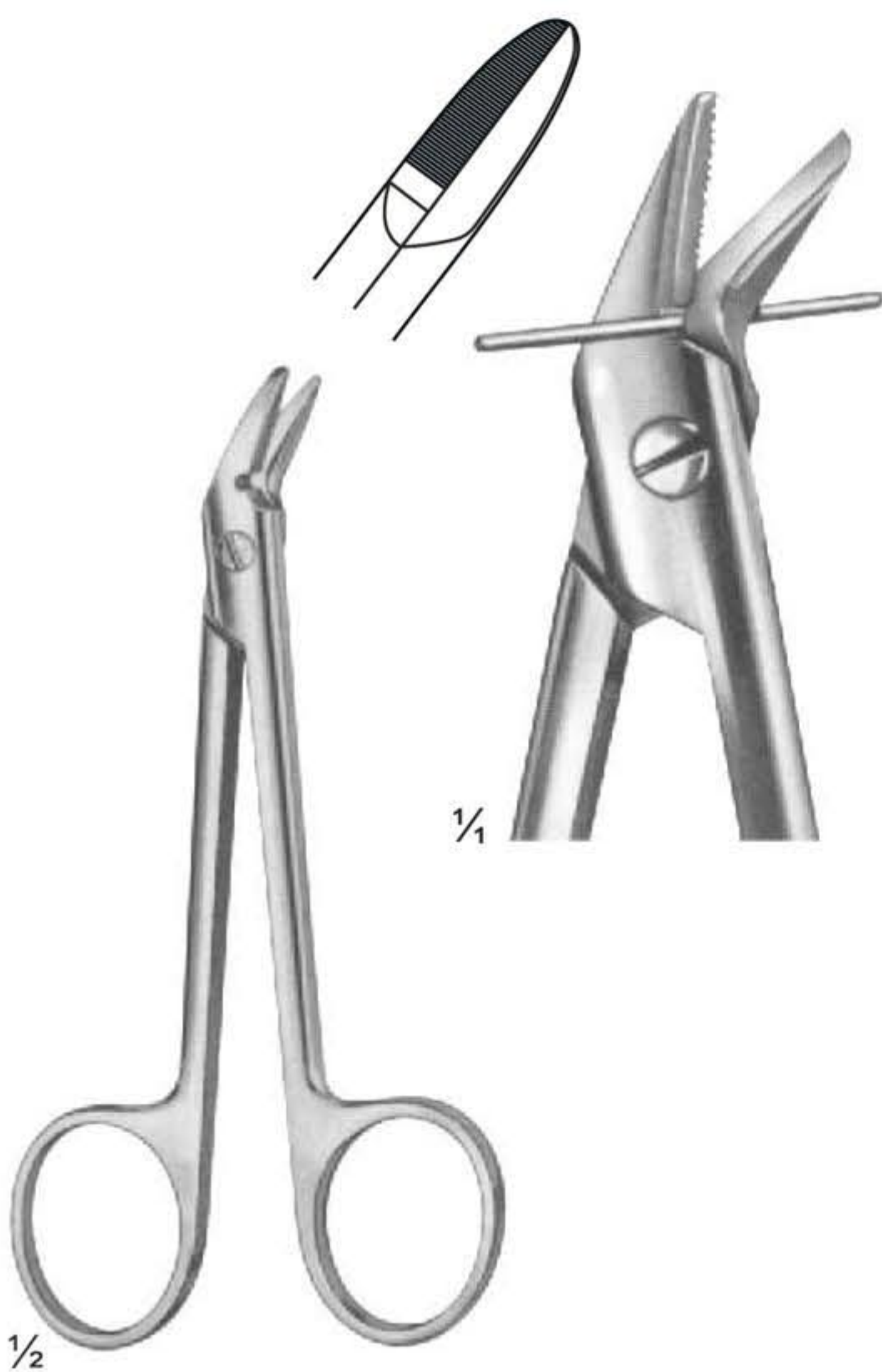

1/2

**03-339**  
1 Blade Serrated  
Size: 120 mm

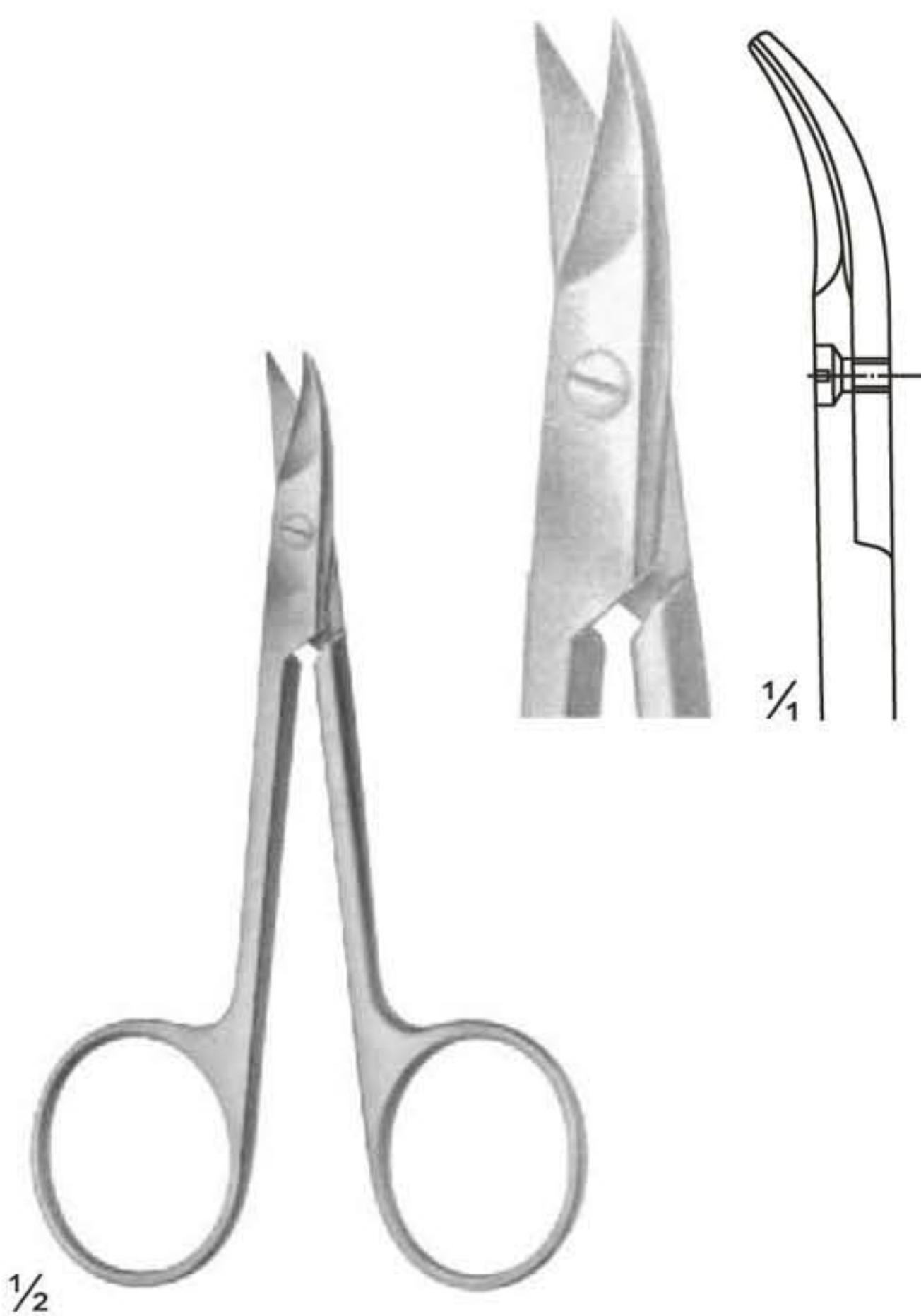

1/2

**03-340**  
STRACK  
Size: 100 mm

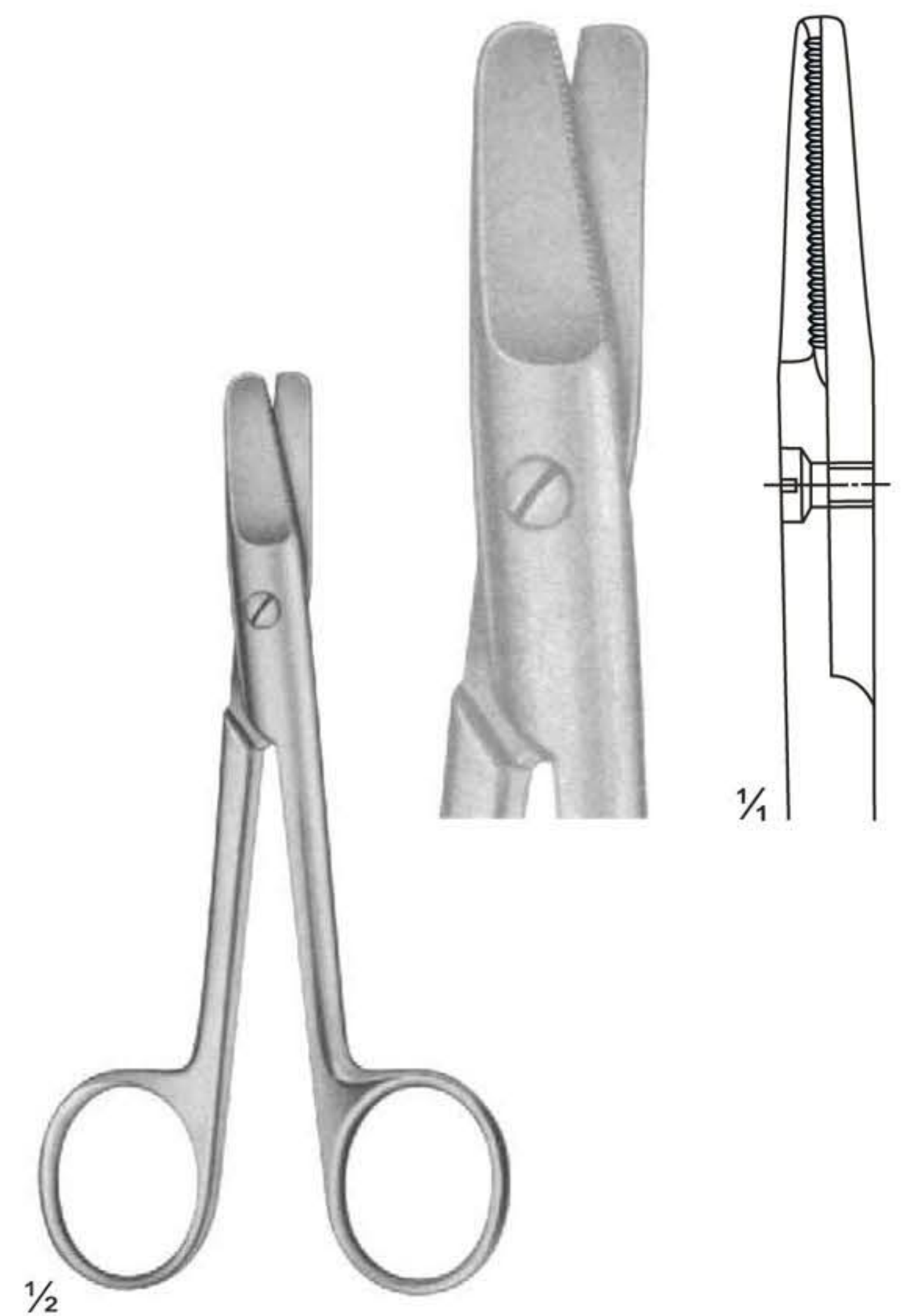

1/2

**03-341**  
HARVEY  
Size: 125 mm



**Wire and Plate Scissors**





**Bandage and Cloth Scissors**



**03-352**  
UNIVERSAL AND BANDAGE SCISSORS  
180 mm

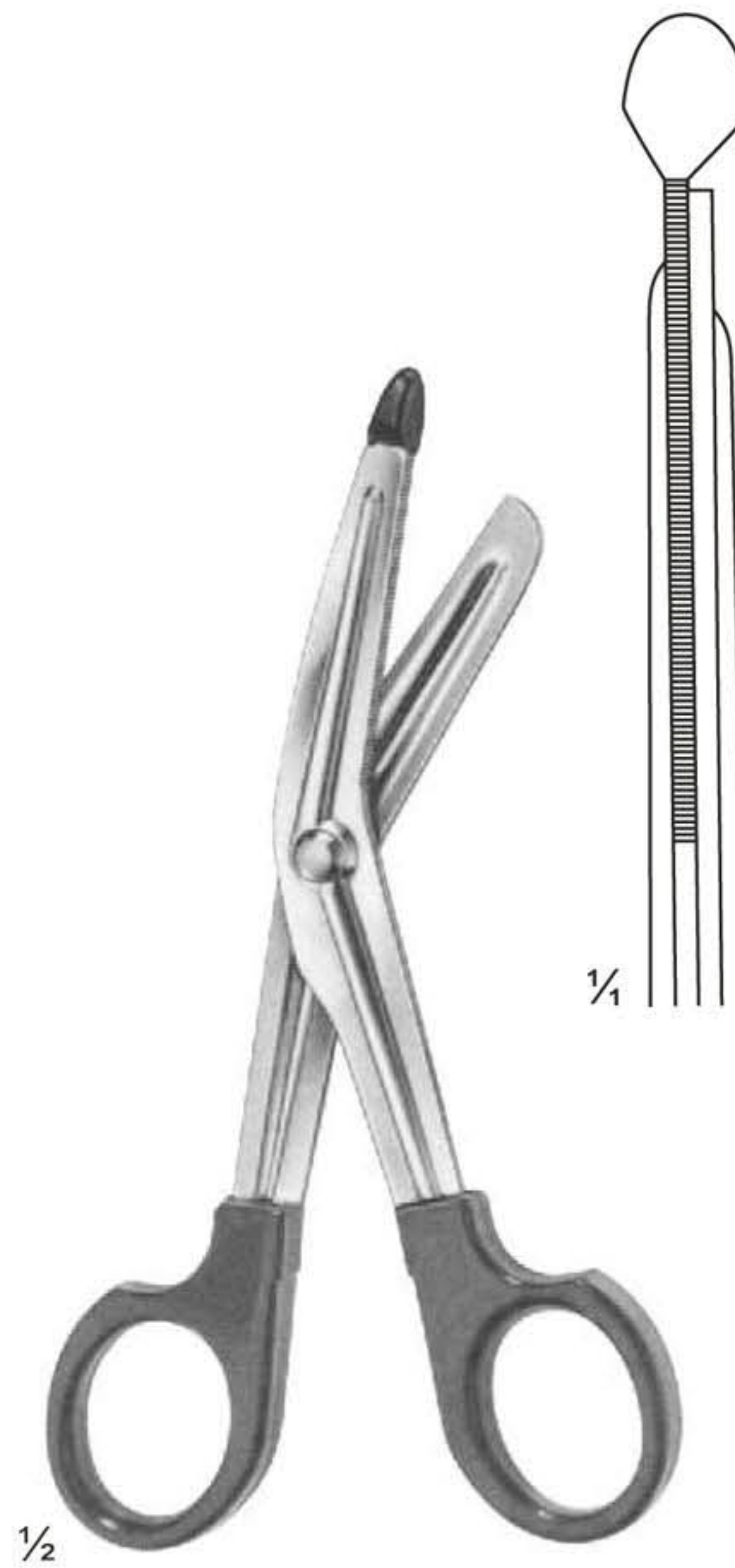

**03-353**  
LISTER  
Size: 145 mm

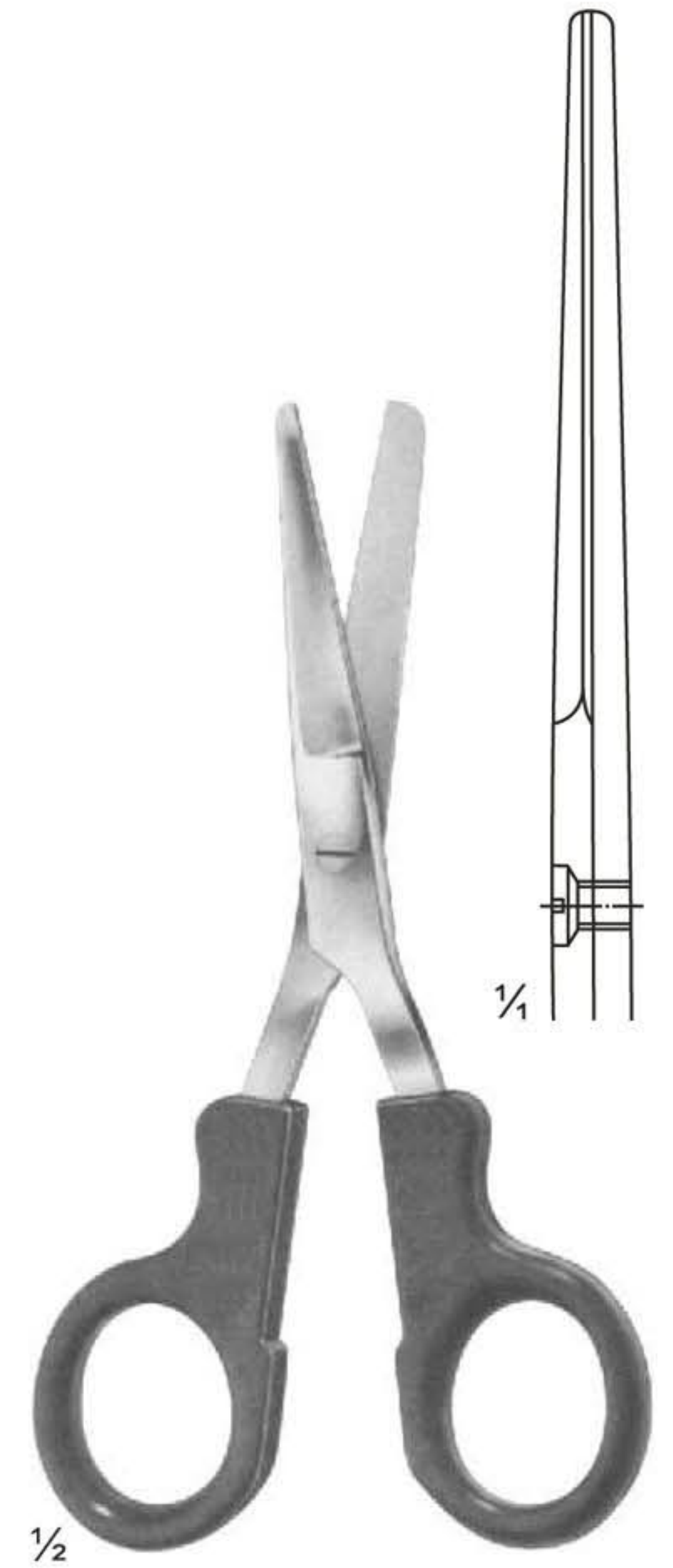

**03-354**  
LISTER  
Size: 145 mm

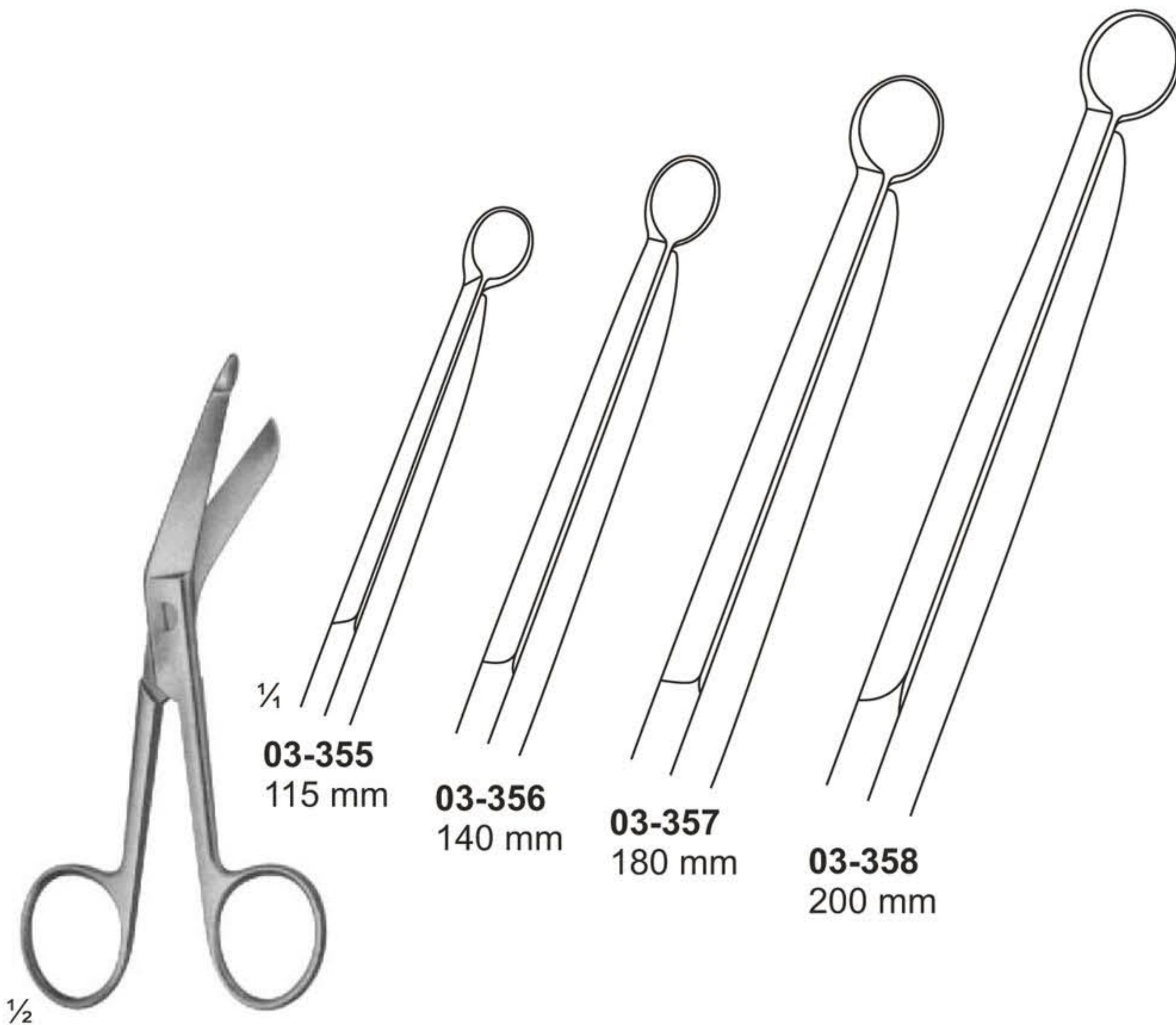

**03-355 - 358**  
LISTER

**03-355**  
115 mm

**03-356**  
140 mm

**03-357**  
180 mm

**03-358**  
200 mm

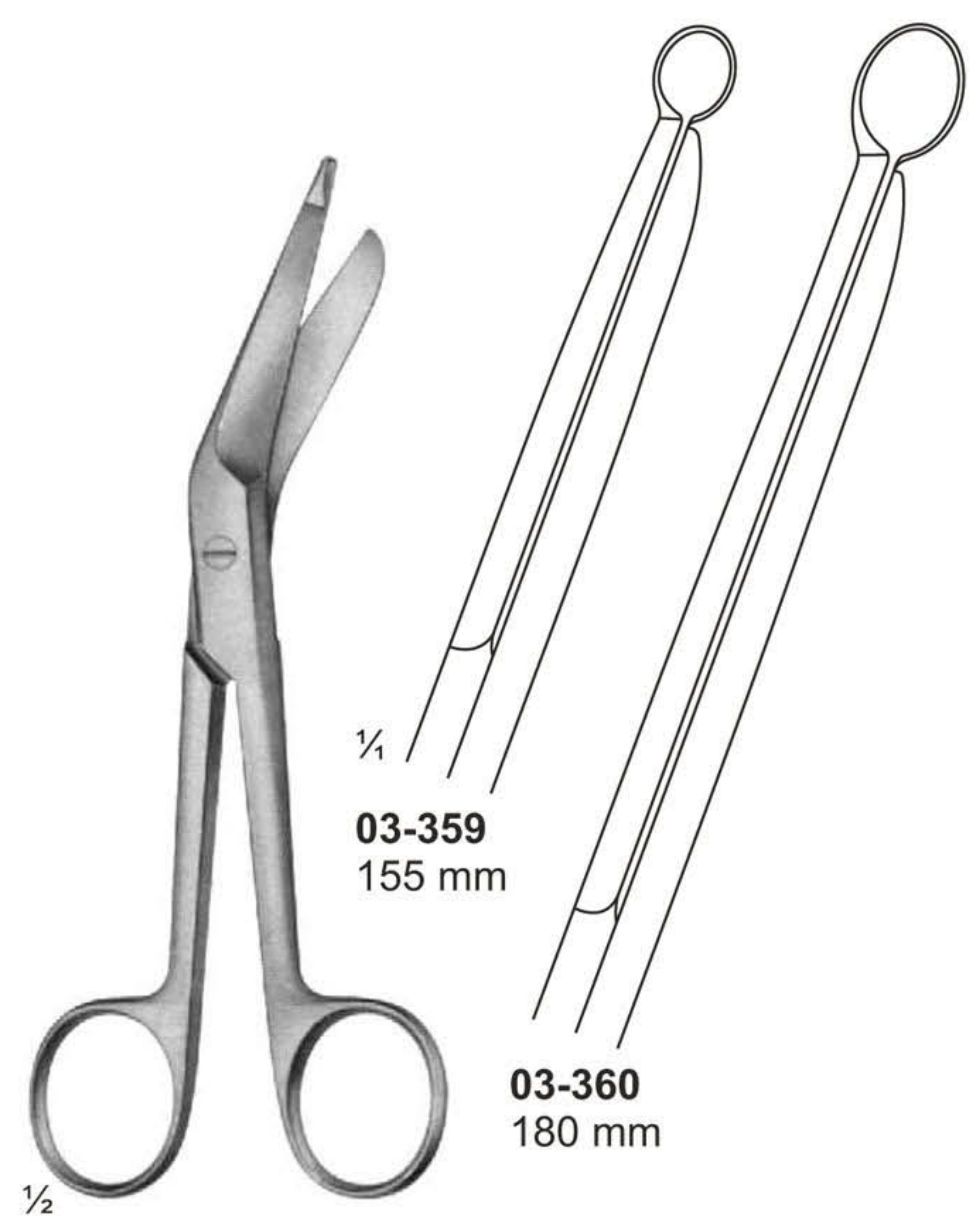

**03-359 - 360**  
LISTER

**03-359**  
155 mm

**03-360**  
180 mm



**Bandage, Cloth and Plaster Scissors**

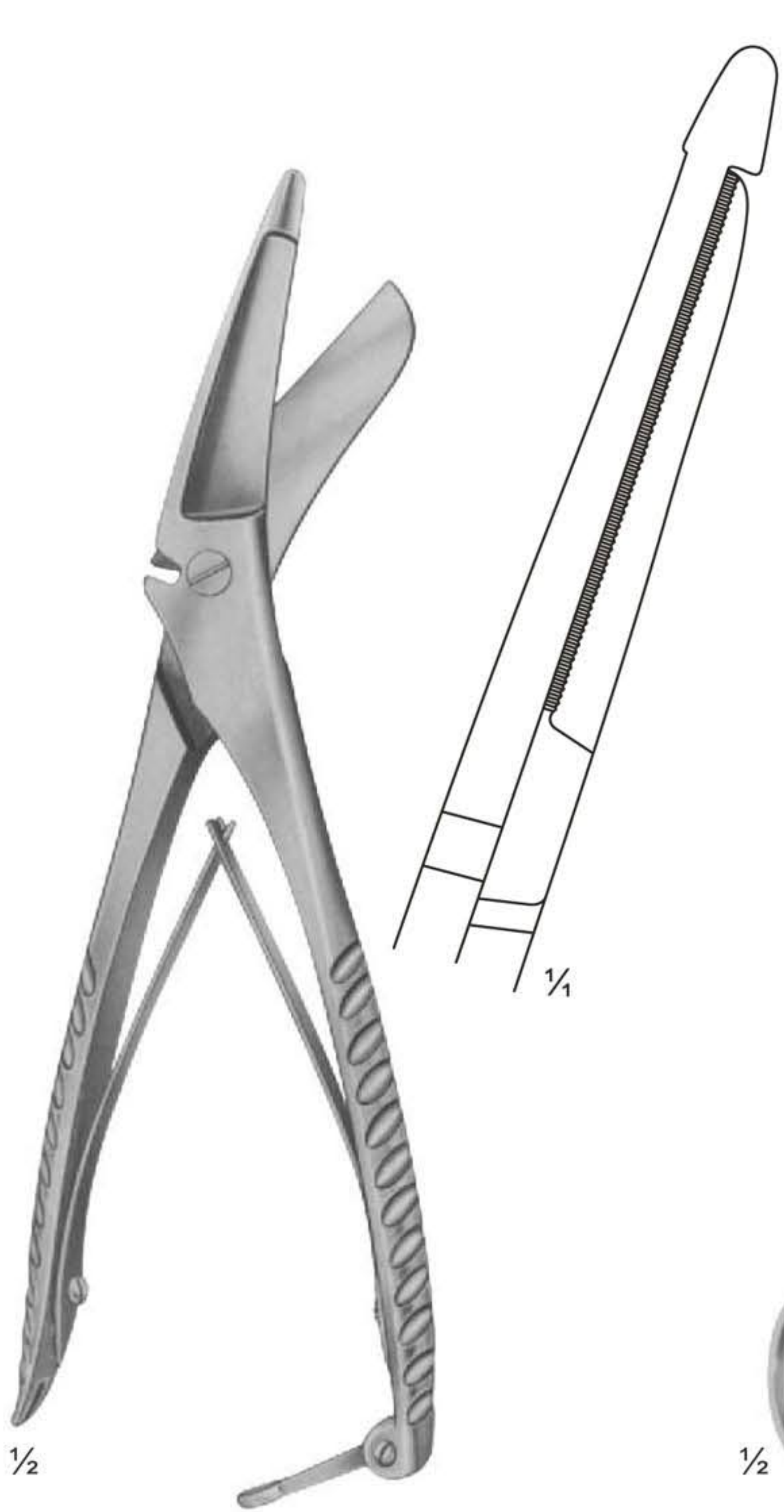

**03-361**  
CLOTH SCISSORS  
205 mm

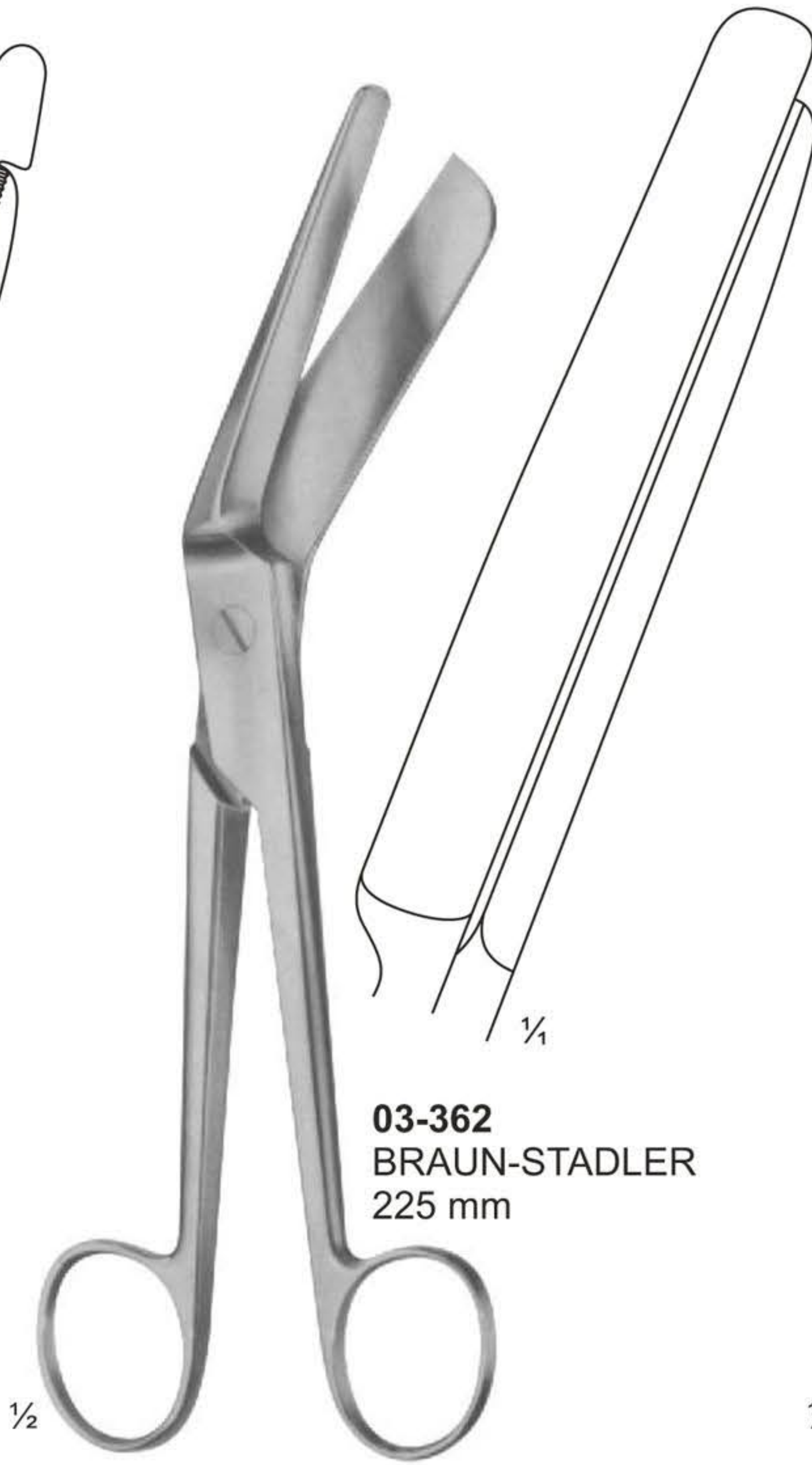

**03-362**  
BRAUN-STADLER  
225 mm



**03-363**  
SEUTIN  
230 mm

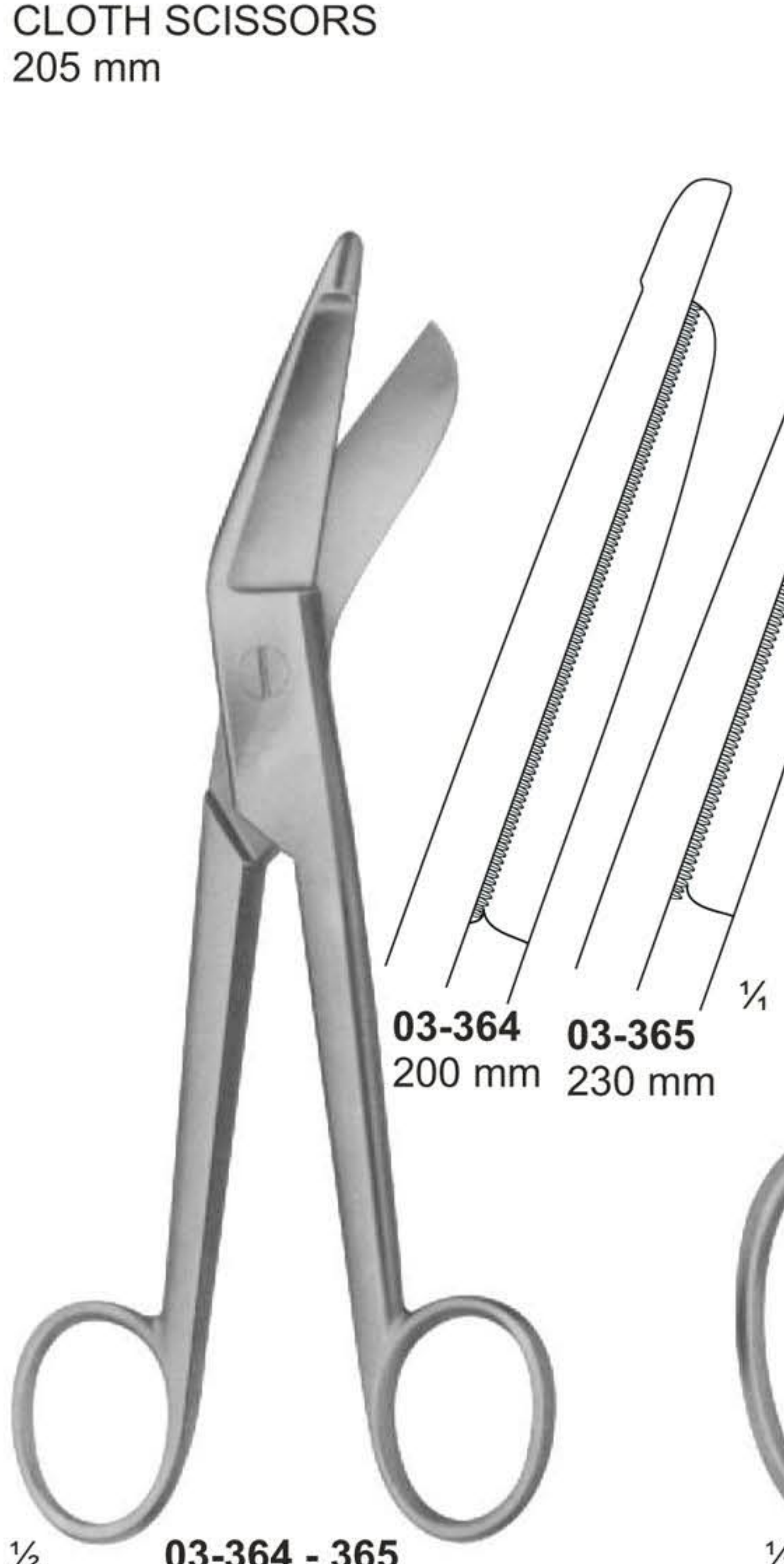

**03-364 - 365**  
ESMARCH

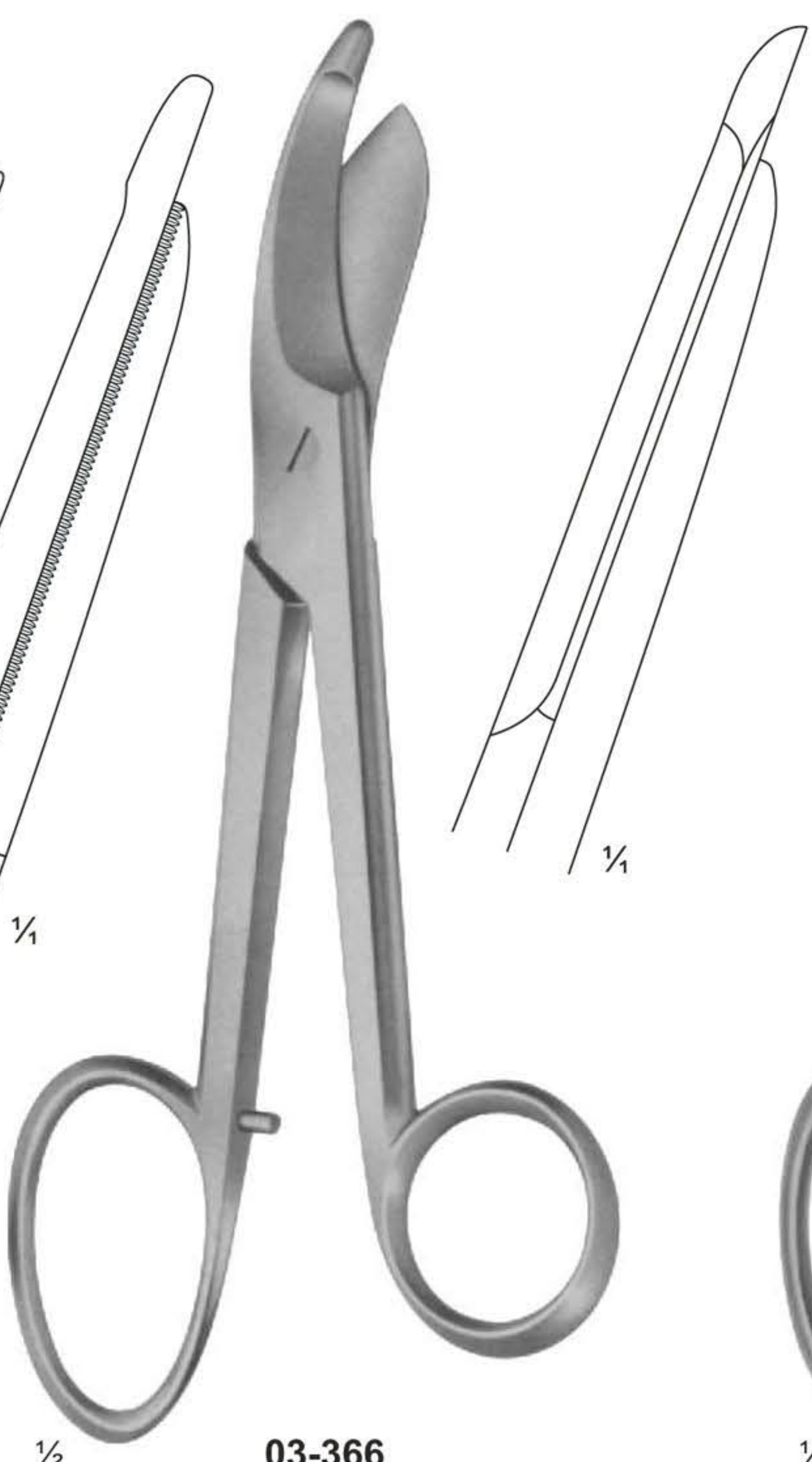

**03-366**  
BRUNS  
235 mm

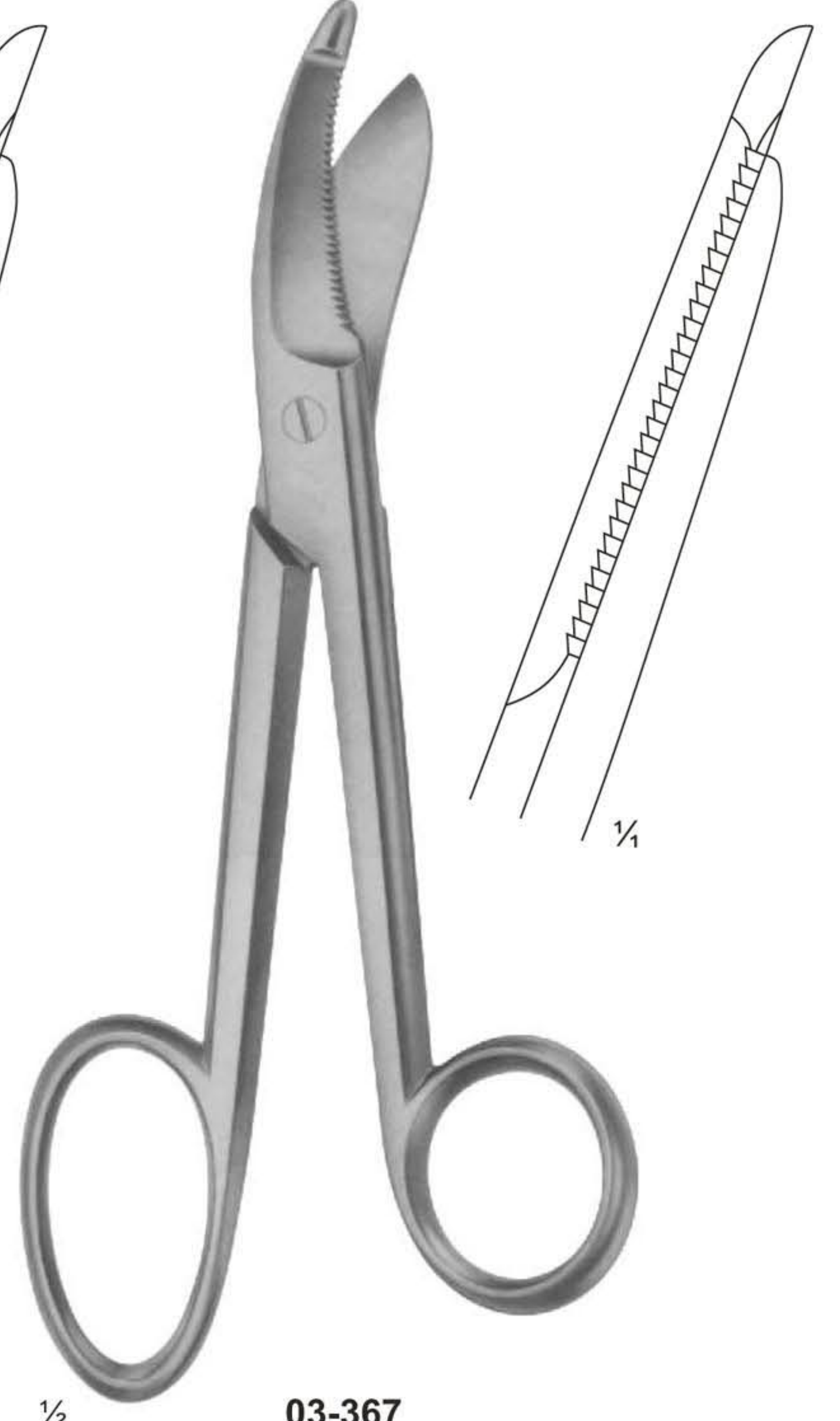

**03-367**  
BRUNS  
235 mm



# Micro Forceps, Jeweler Types

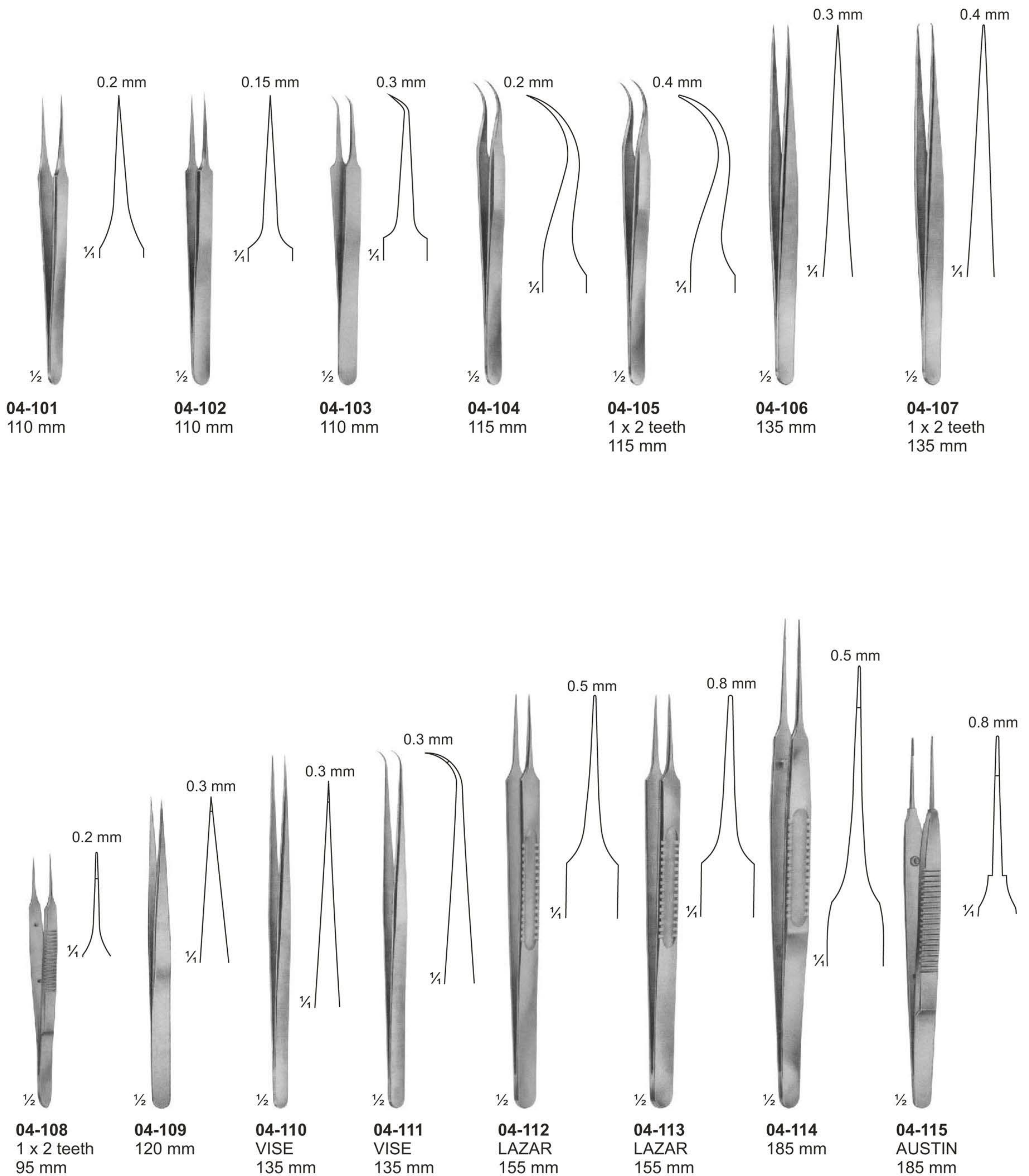



Ligature Forceps, Micro Forceps (Light Patterns)

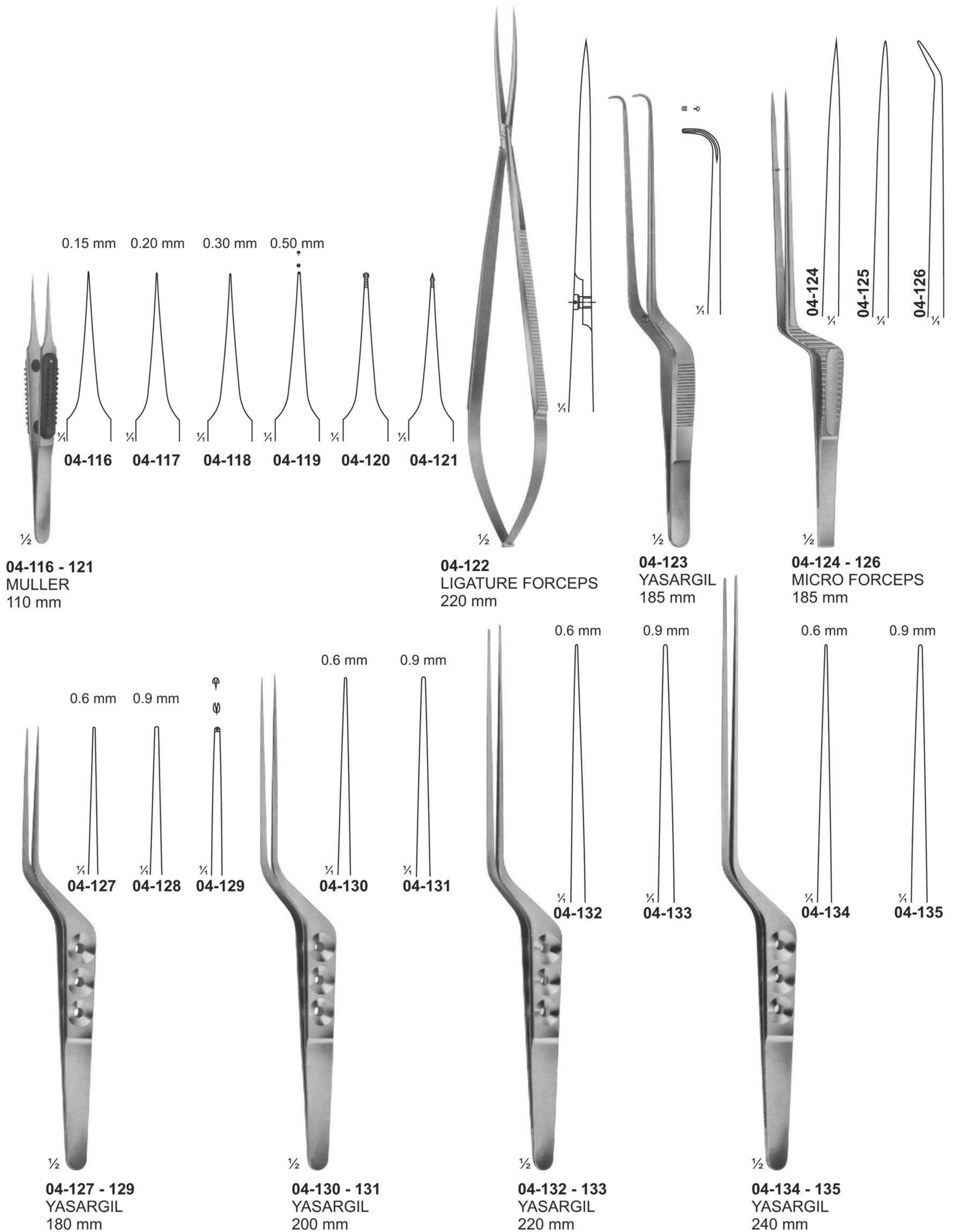



## Forceps for Grasping Tissue, Tumors

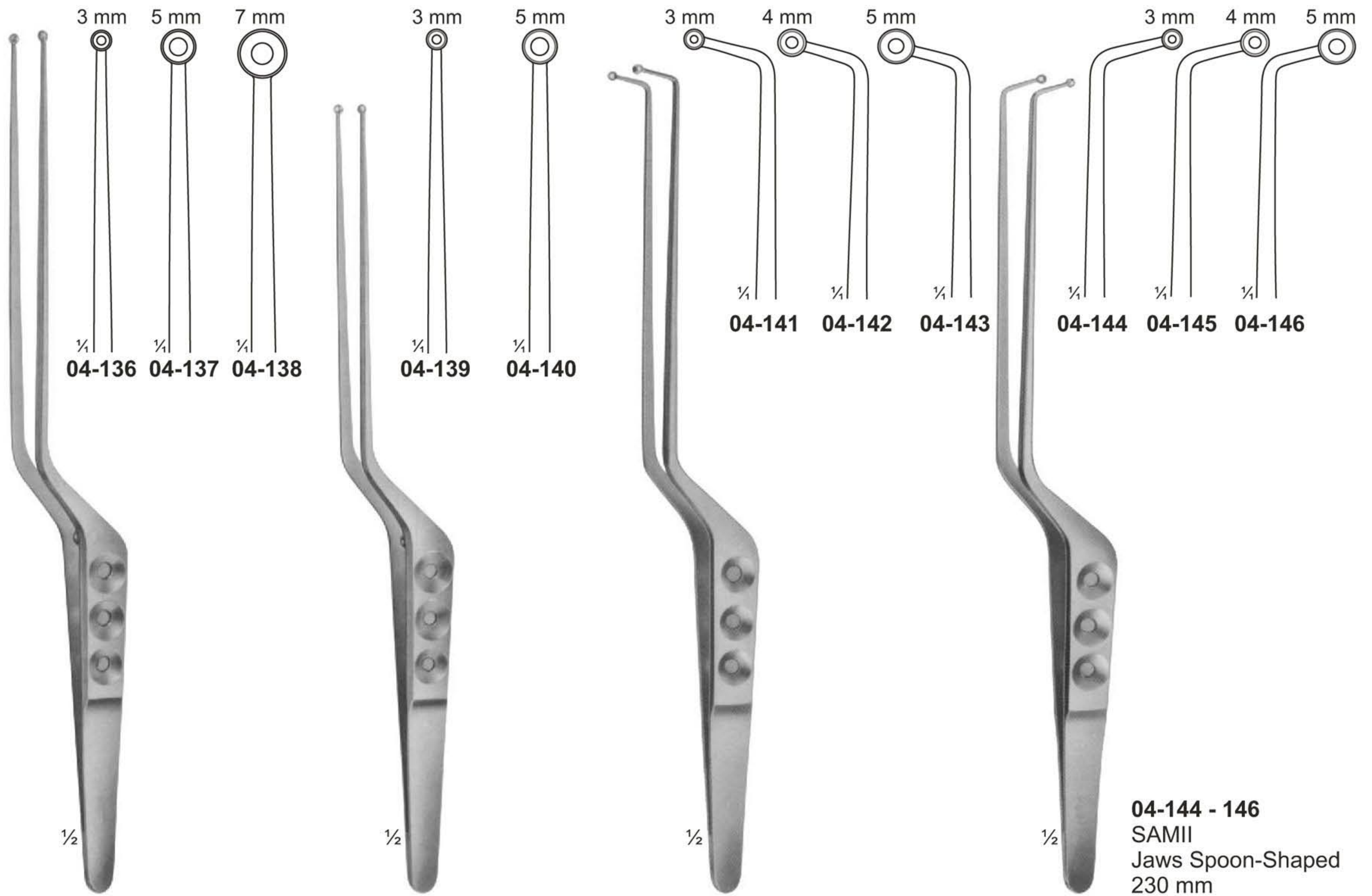

**04-136 - 138**  
 YASARGIL-SAMI  
 Jaws Spoon-Shaped  
 240 mm

**04-139 - 140**  
 YASARGIL  
 Jaws Spoon-Shaped  
 220 mm

**04-141 - 143**  
 SAMII  
 Jaws Spoon-Shaped  
 230 mm

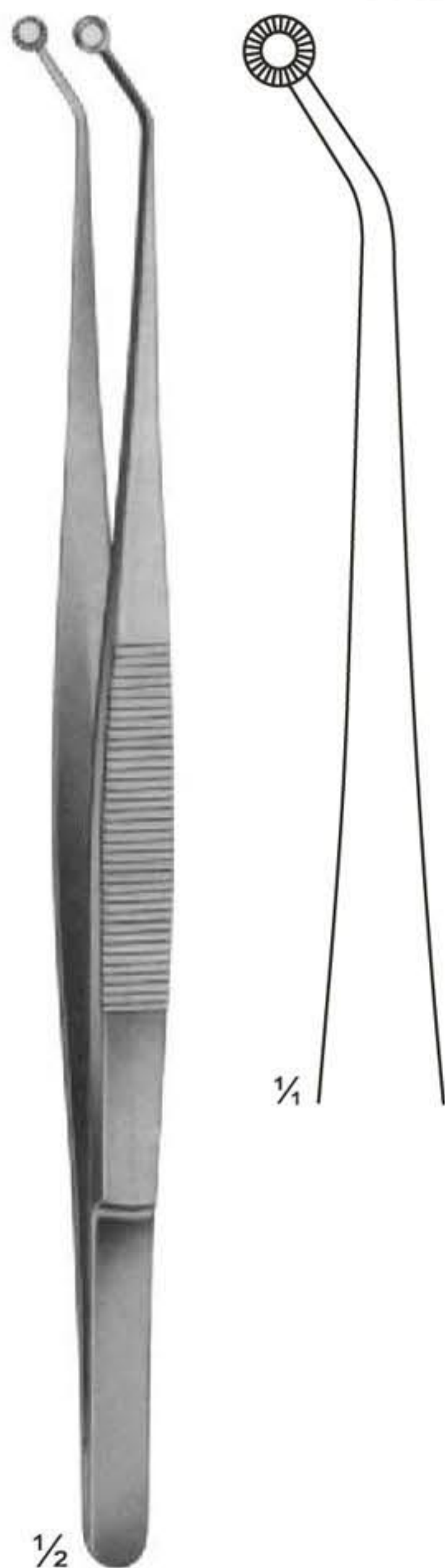

**04-147**  
 HUNT  
 Tumor-and Vessel Forceps  
 200 mm

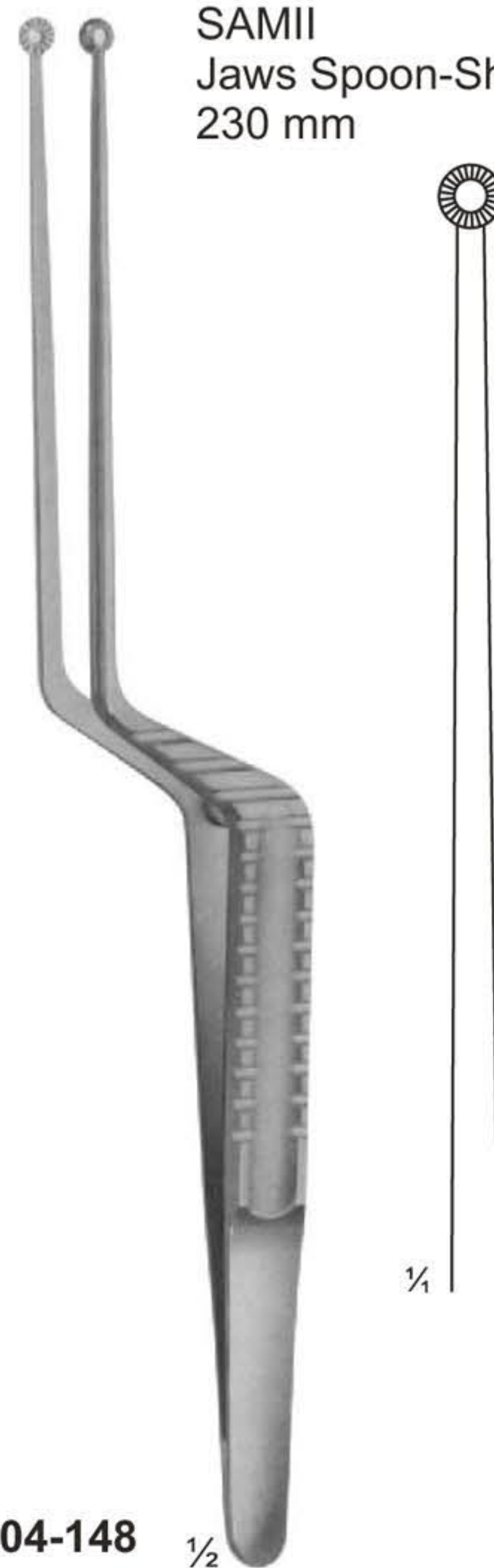

**04-148**  
 HUNT  
 Tumor-and Vessel Forceps  
 200 mm

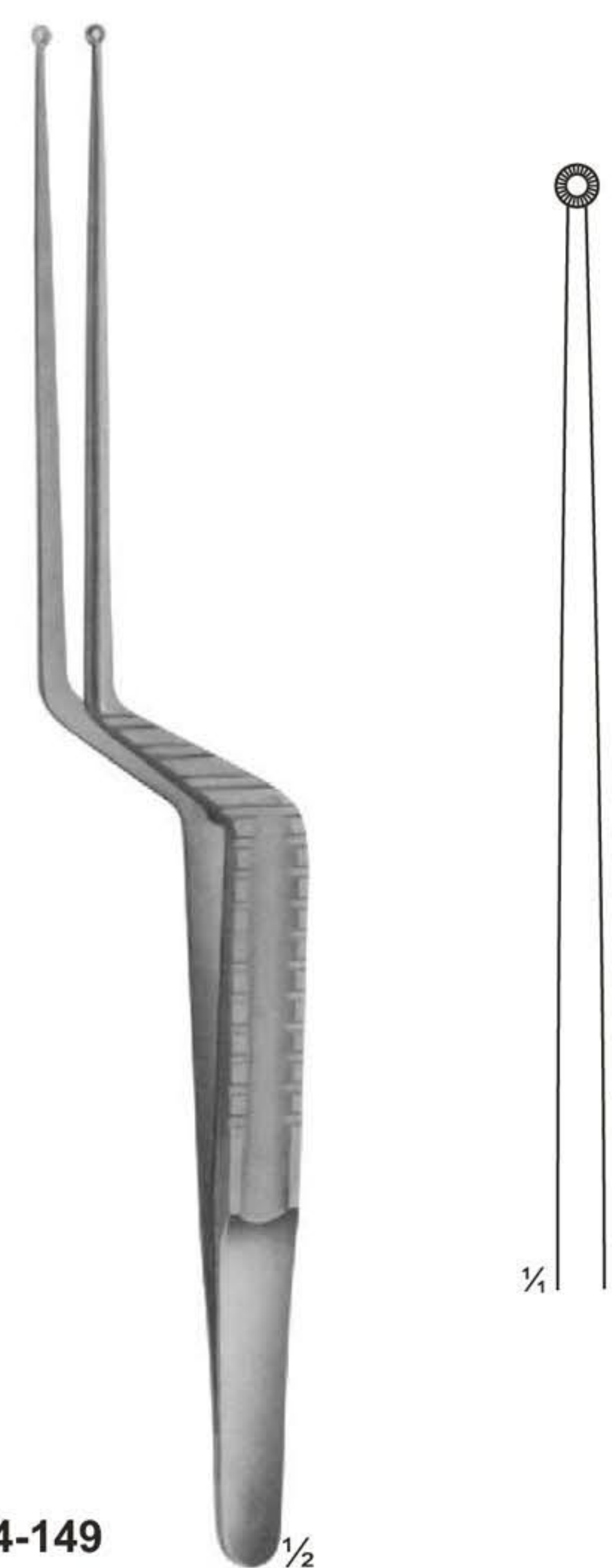

**04-149**  
 YASARGIL  
 Tumor-and Vessel Forceps  
 200 mm



# Delicate Dissecting, Microscopic, Sterilizing Forceps

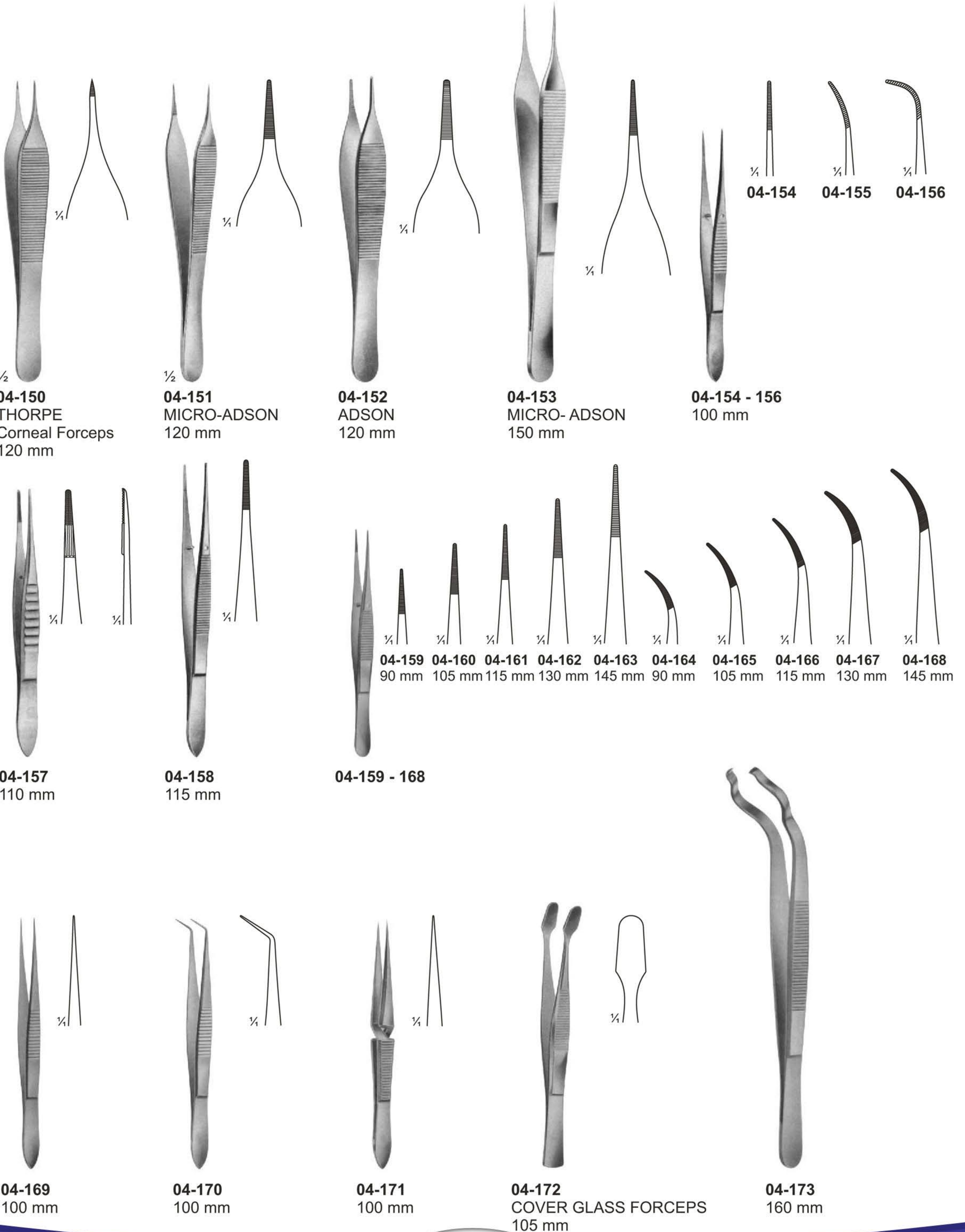



# Delicate Dissecting Forceps

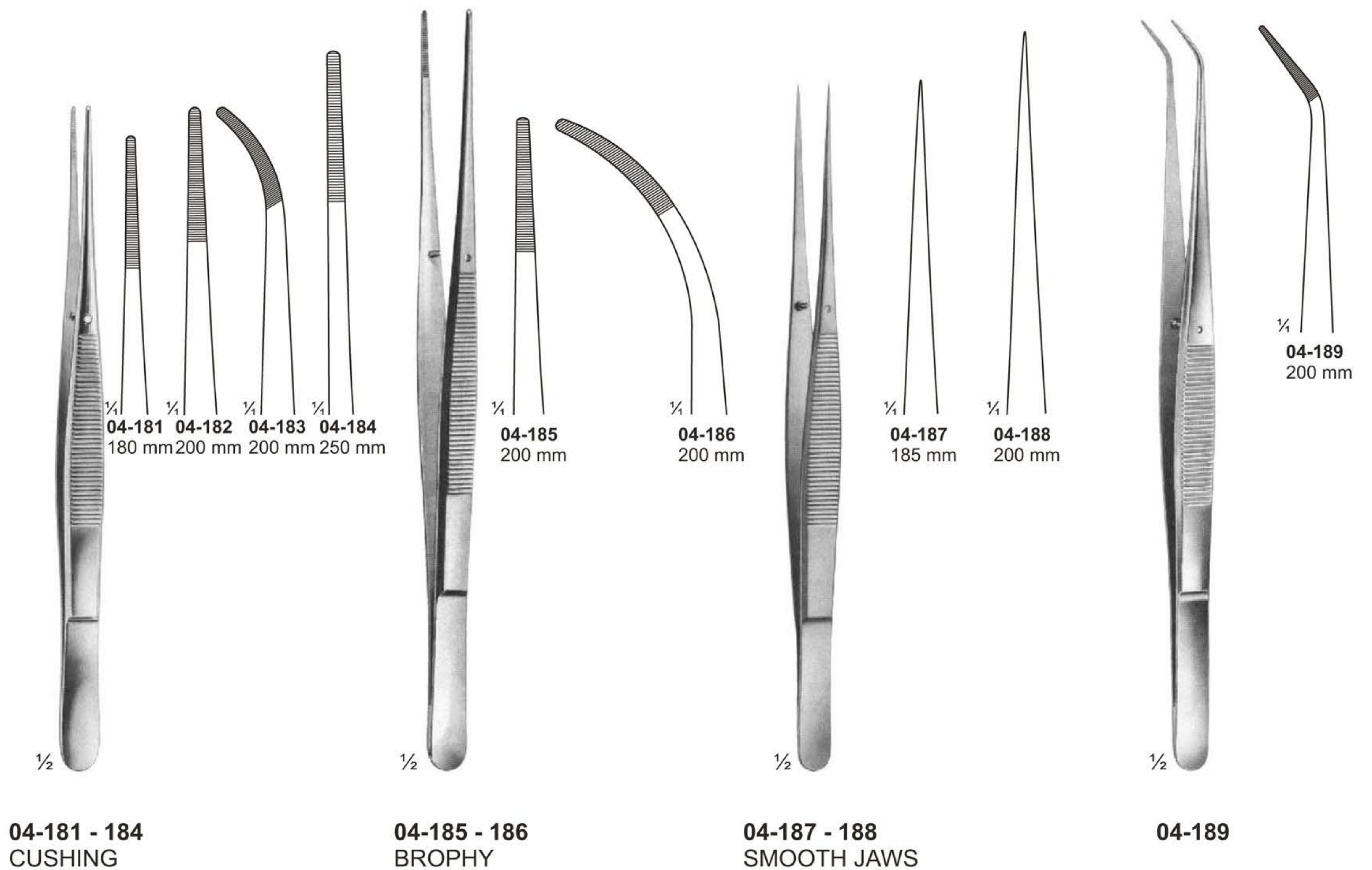
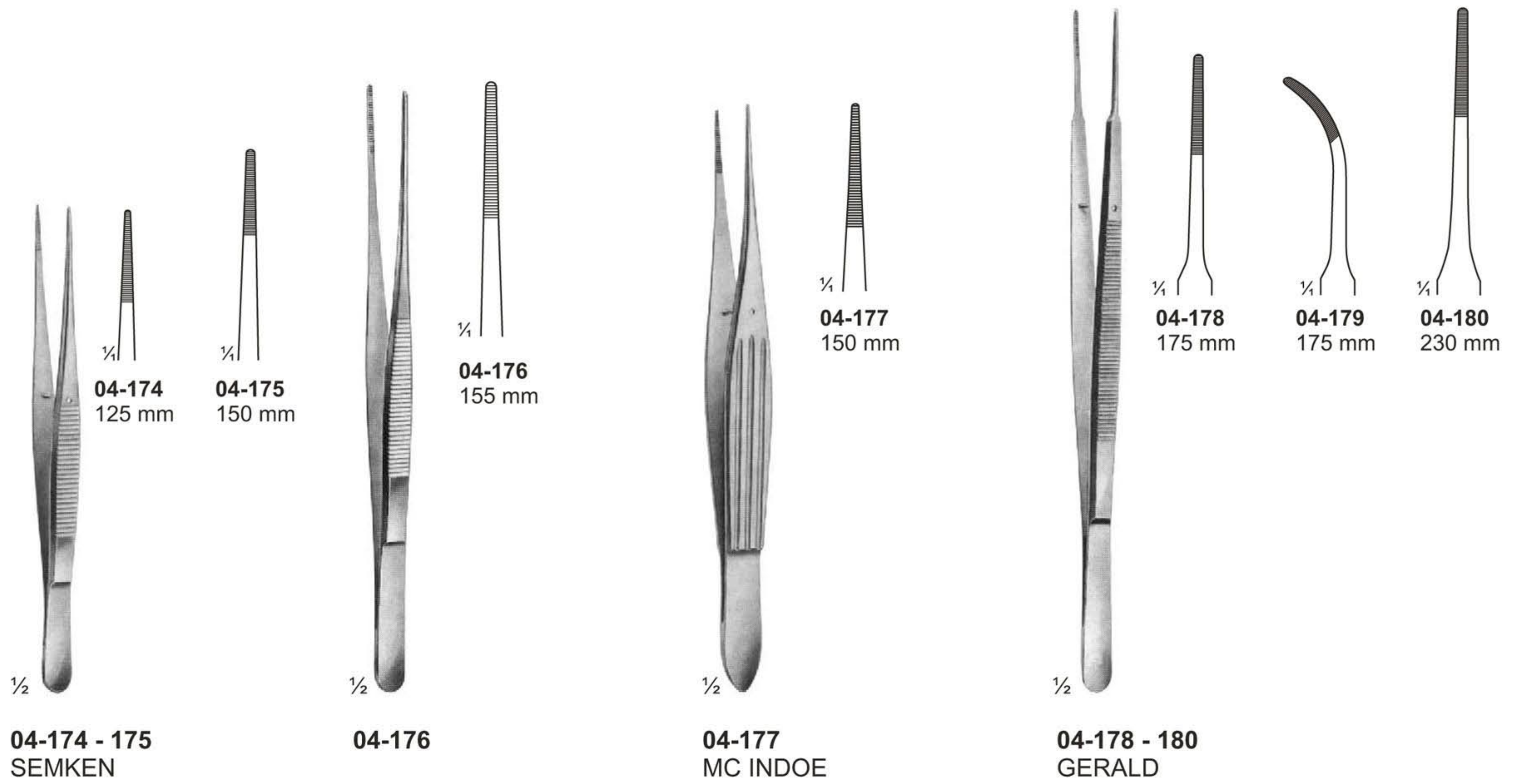



# Dissecting Forceps

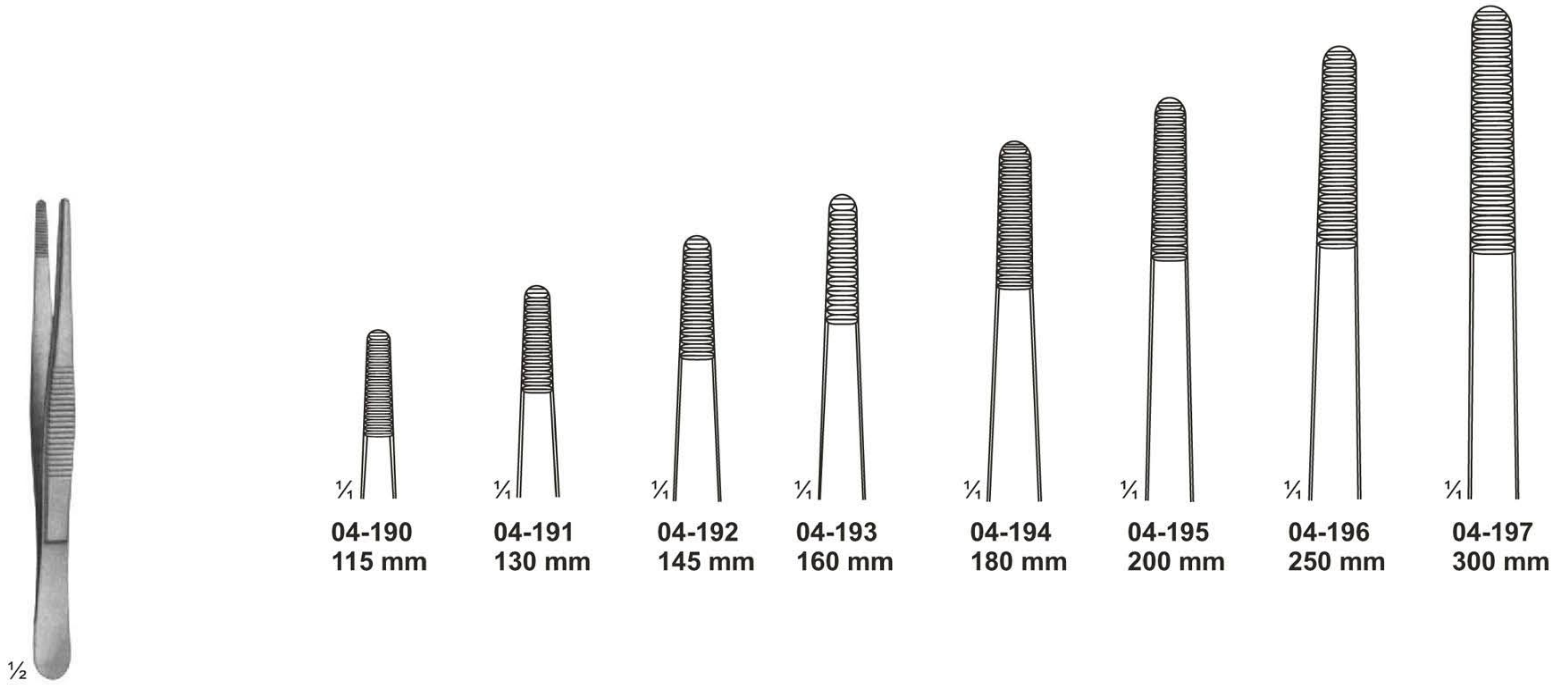

**04-190 - 197**  
STANDARD

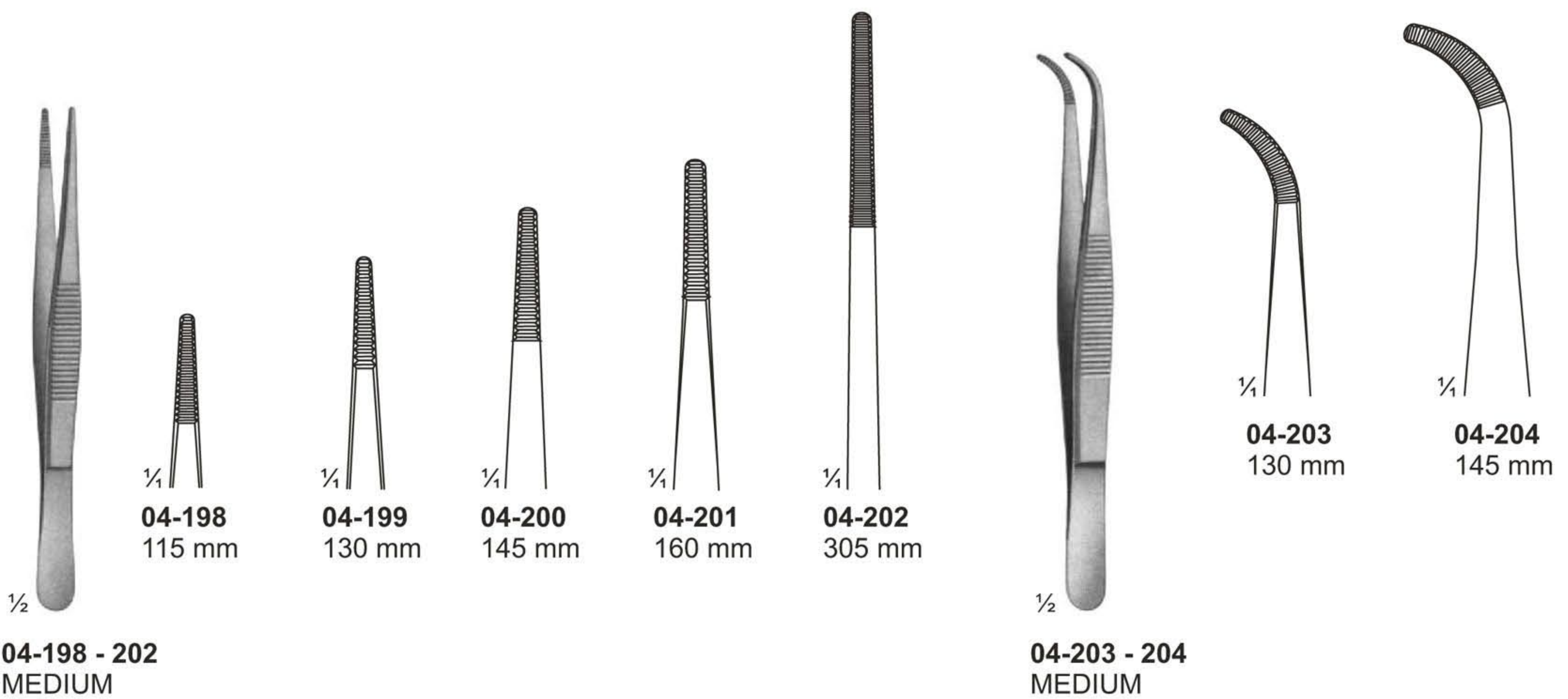

**04-198 - 202**  
MEDIUM

**04-203 - 204**  
MEDIUM



# Dissecting Forceps

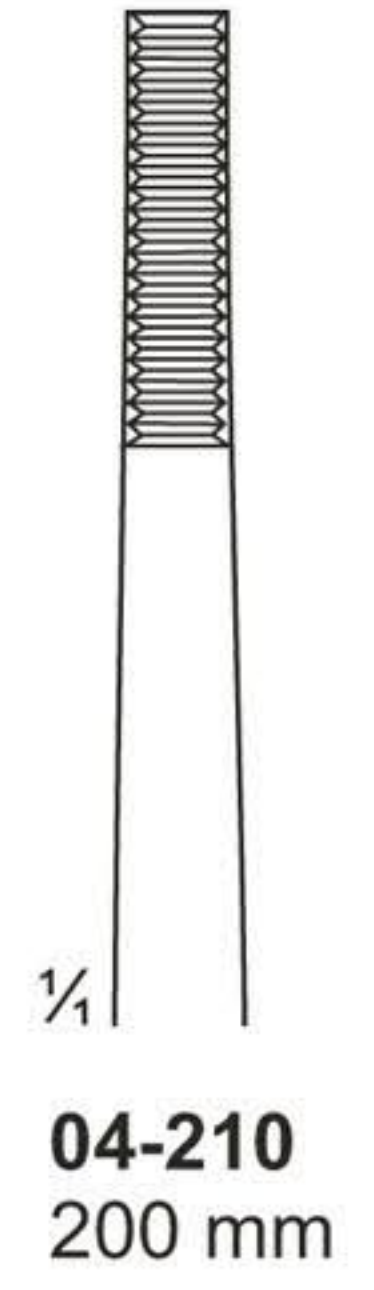
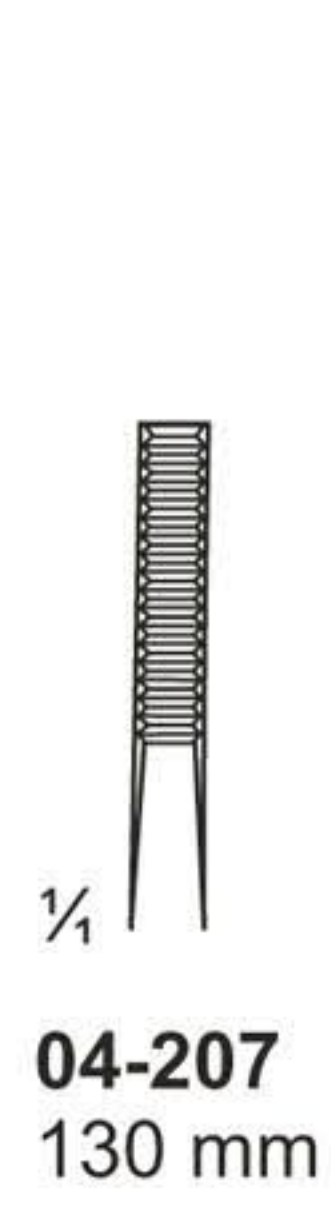

**04-205 - 206**

**04-207 - 210**



**04-211**  
OCHSNER

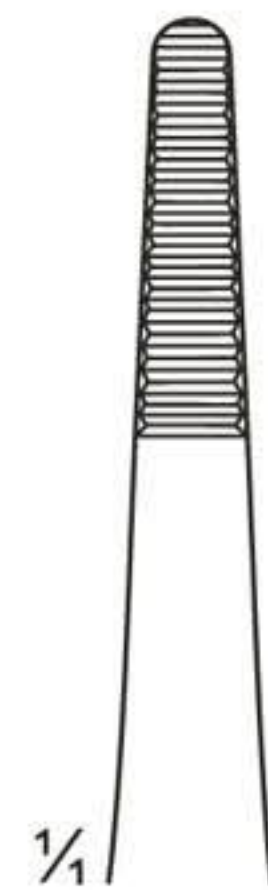

**04-212**  
FRICKE

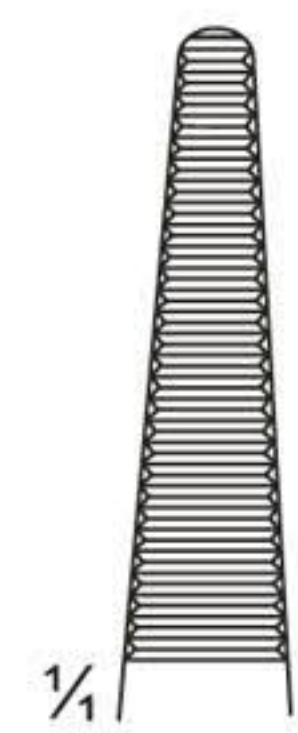
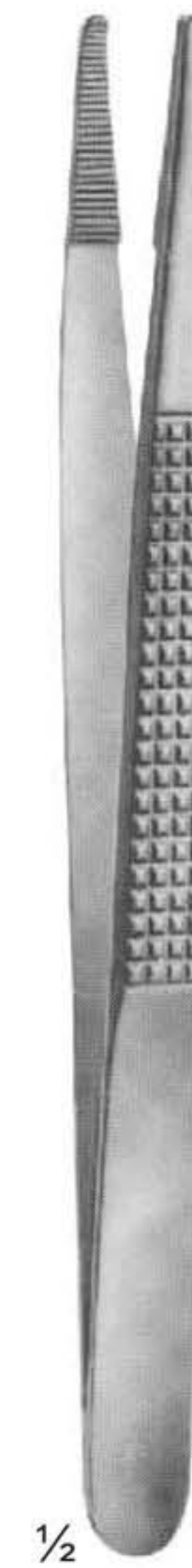

**04-213**  
BONNEY



# Ultra-Light Forceps

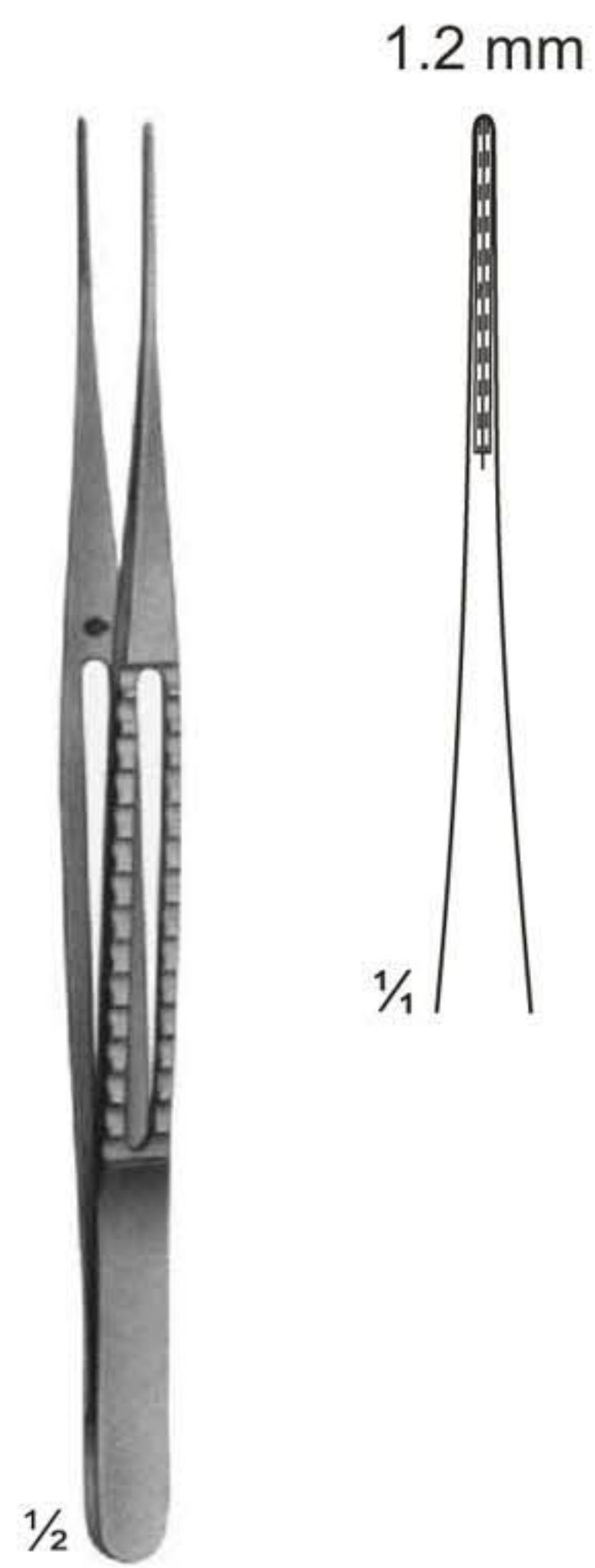

**04-214**  
150 mm

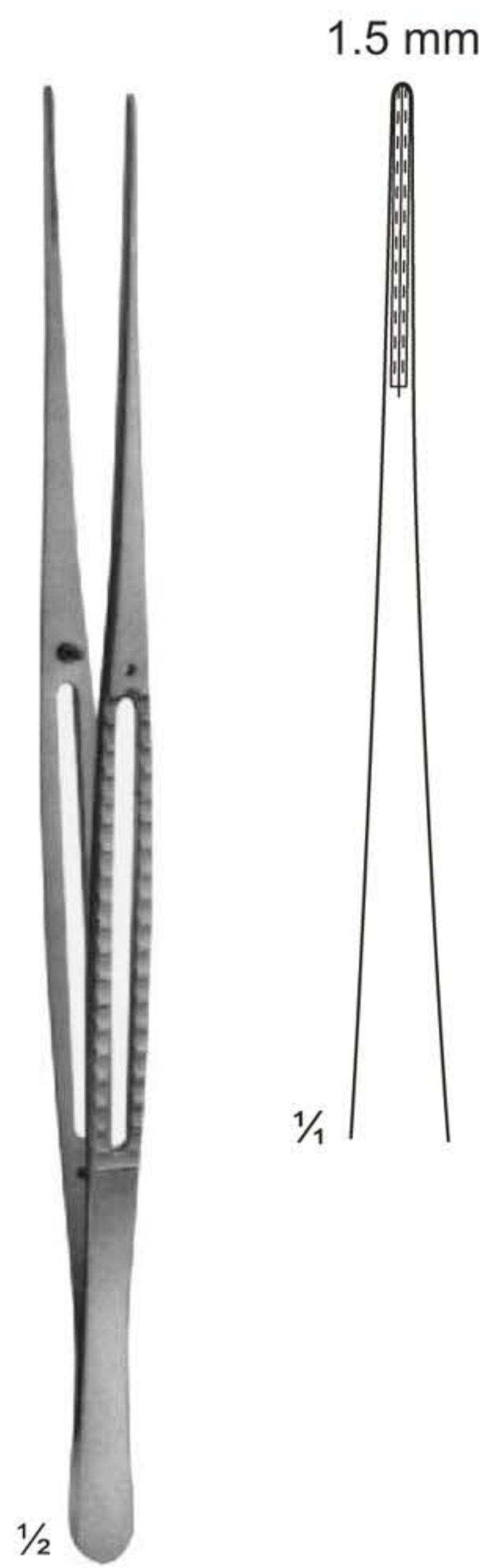

**04-215**  
200 mm

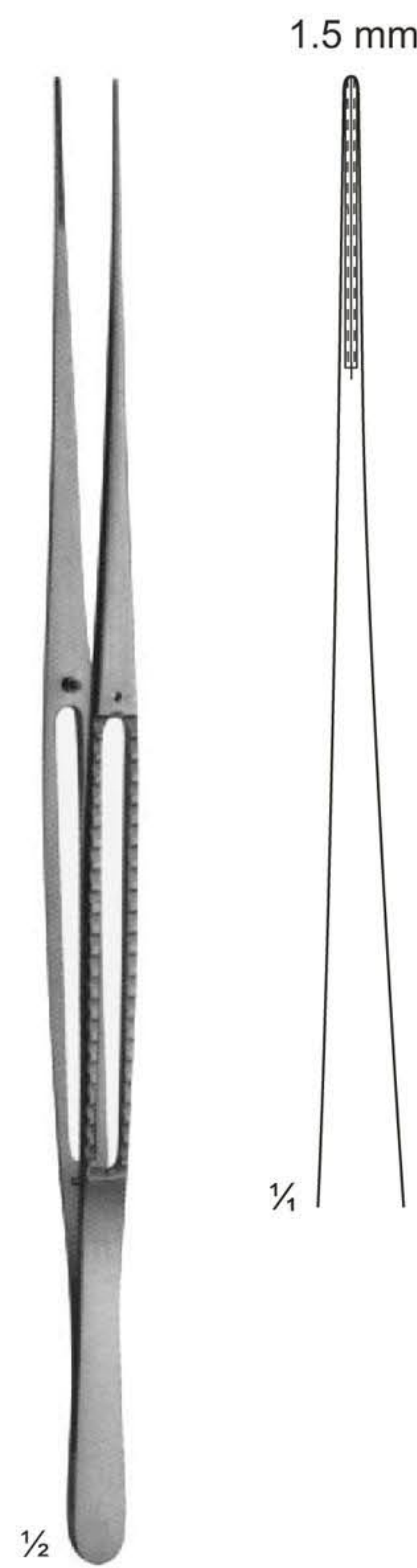

**04-216**  
240 mm

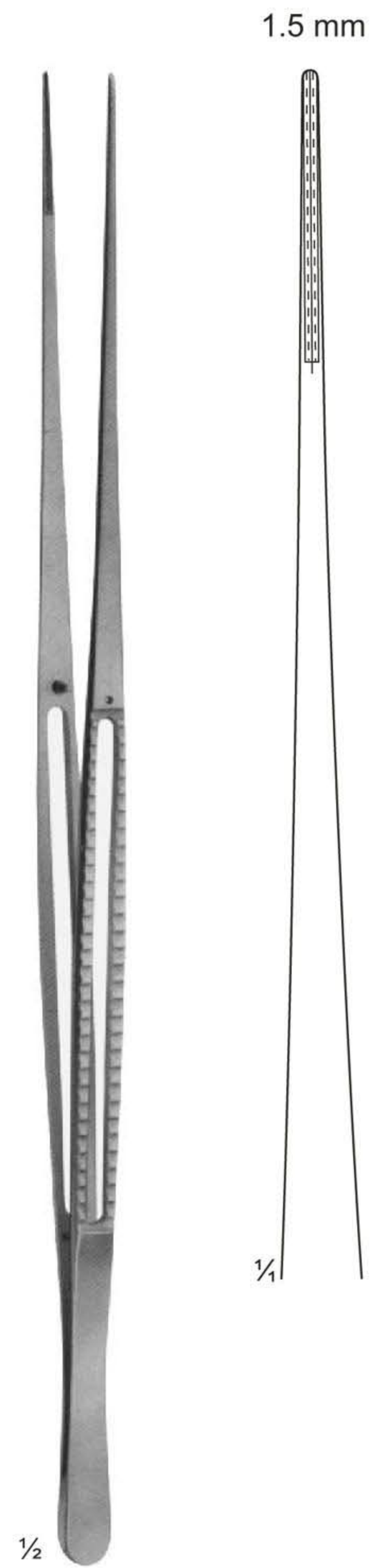

**04-217**  
300 mm



**Forceps**

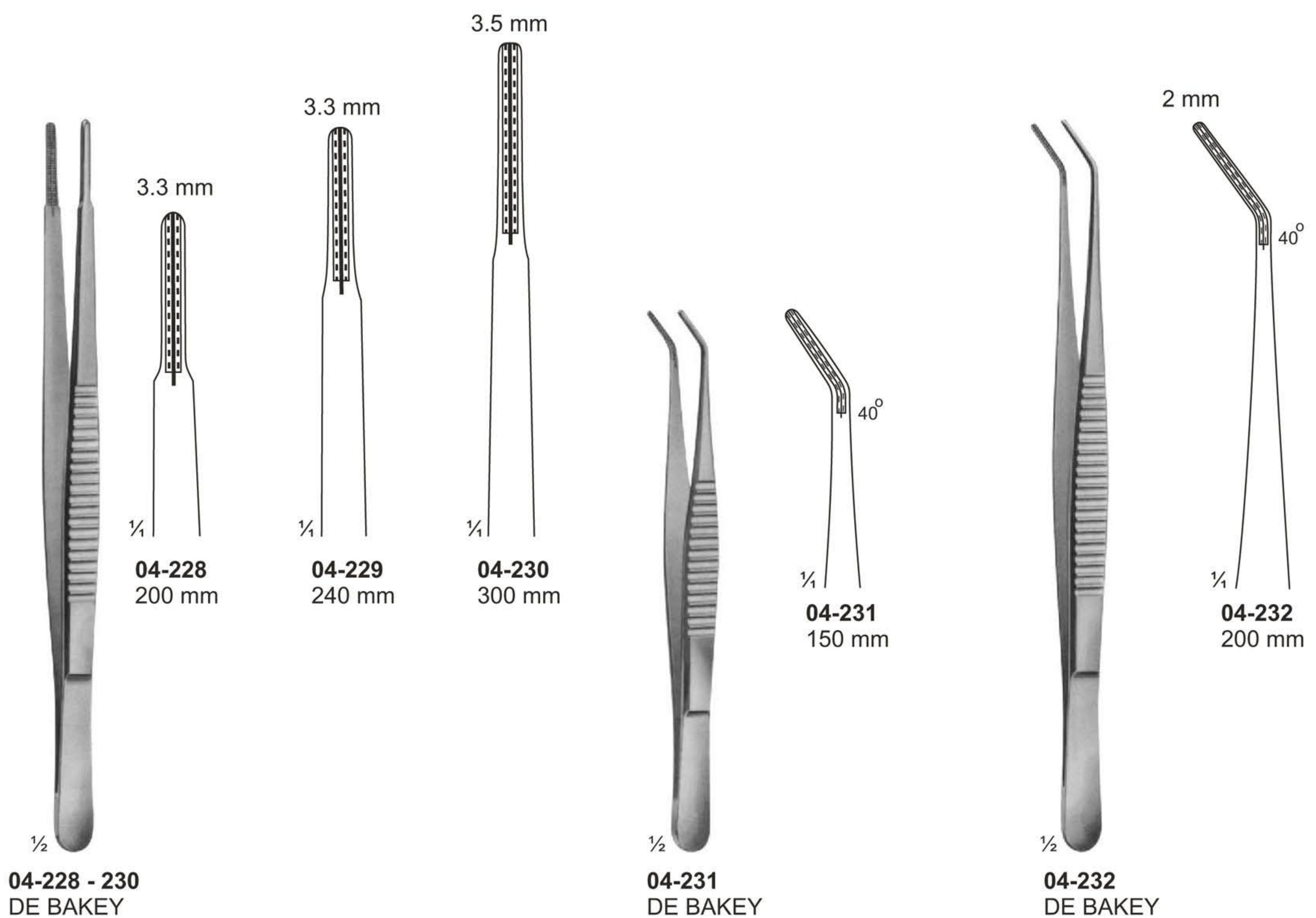
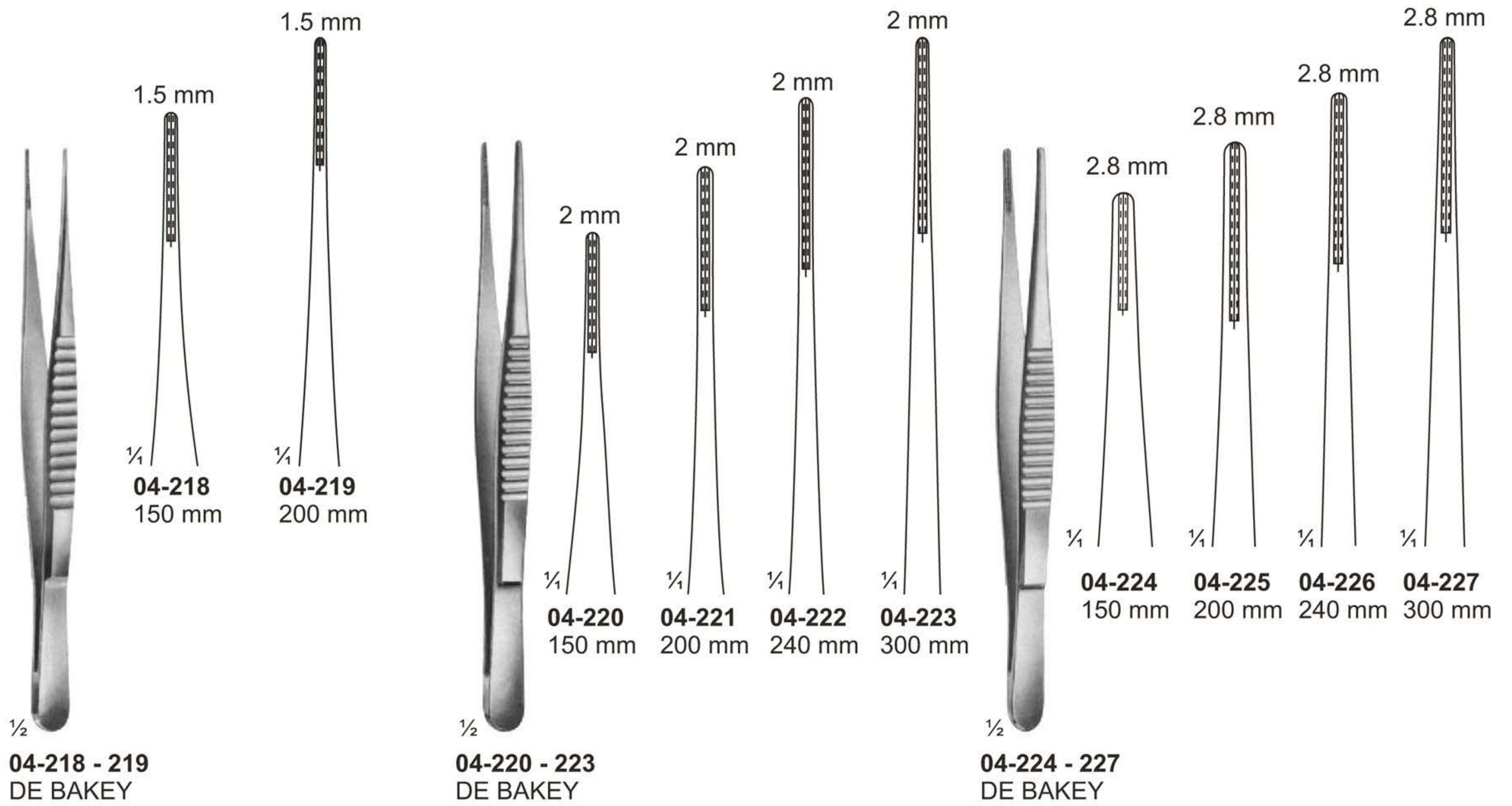

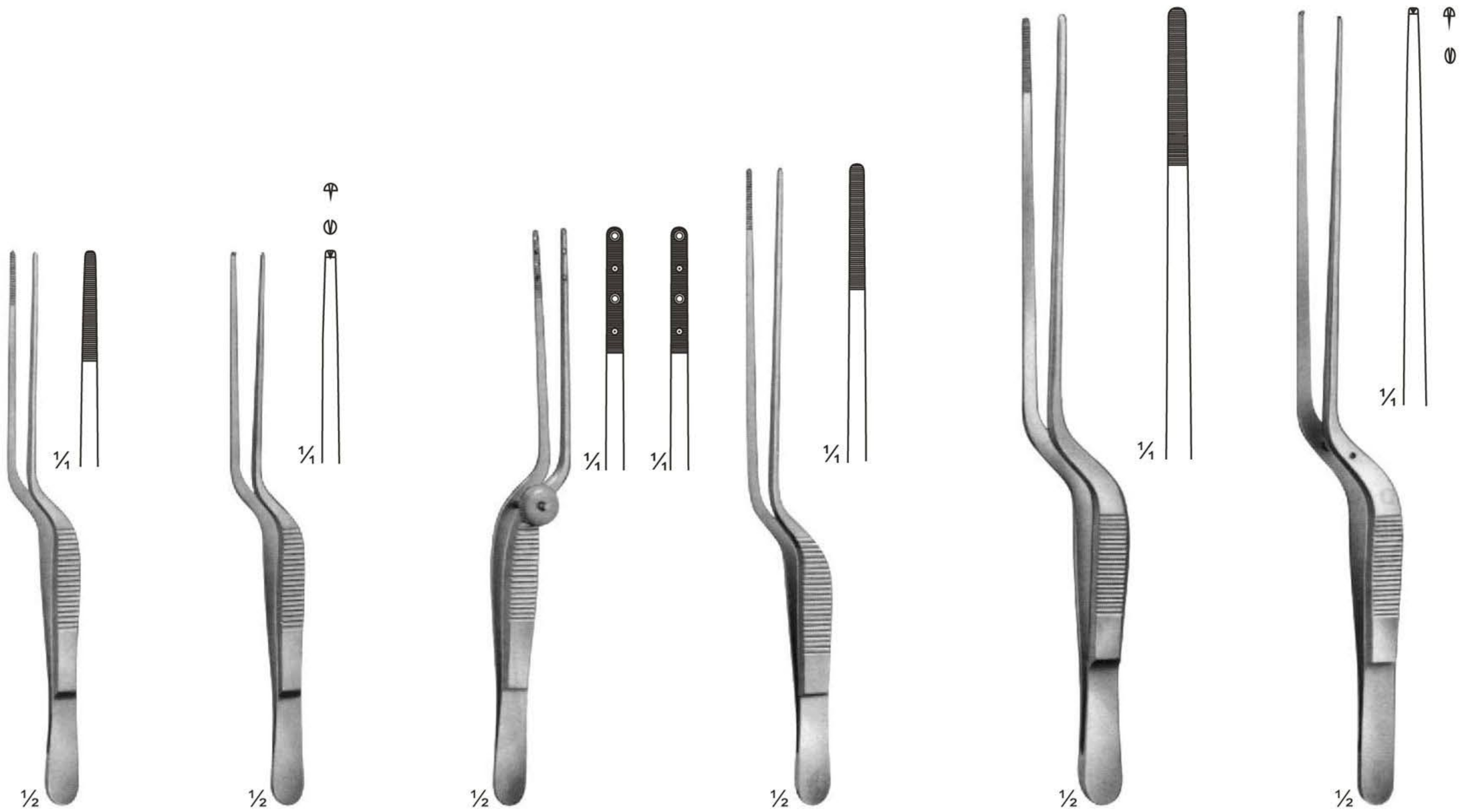

**Forceps, Bayonet - Shaped**

**04-233**  
 LUCAE  
 140 mm

**04-234**  
 LUCAE  
 1x2 teeth  
 140 mm

**04-235**  
 COTTLE  
 Forceps with  
 jaws toothed  
 and serrated  
 140 mm

**04-236**  
 JANSEN  
 160 mm

**04-237**  
 GRUENWALD  
 200 mm

**04-238**  
 1x2 teeth  
 200 mm

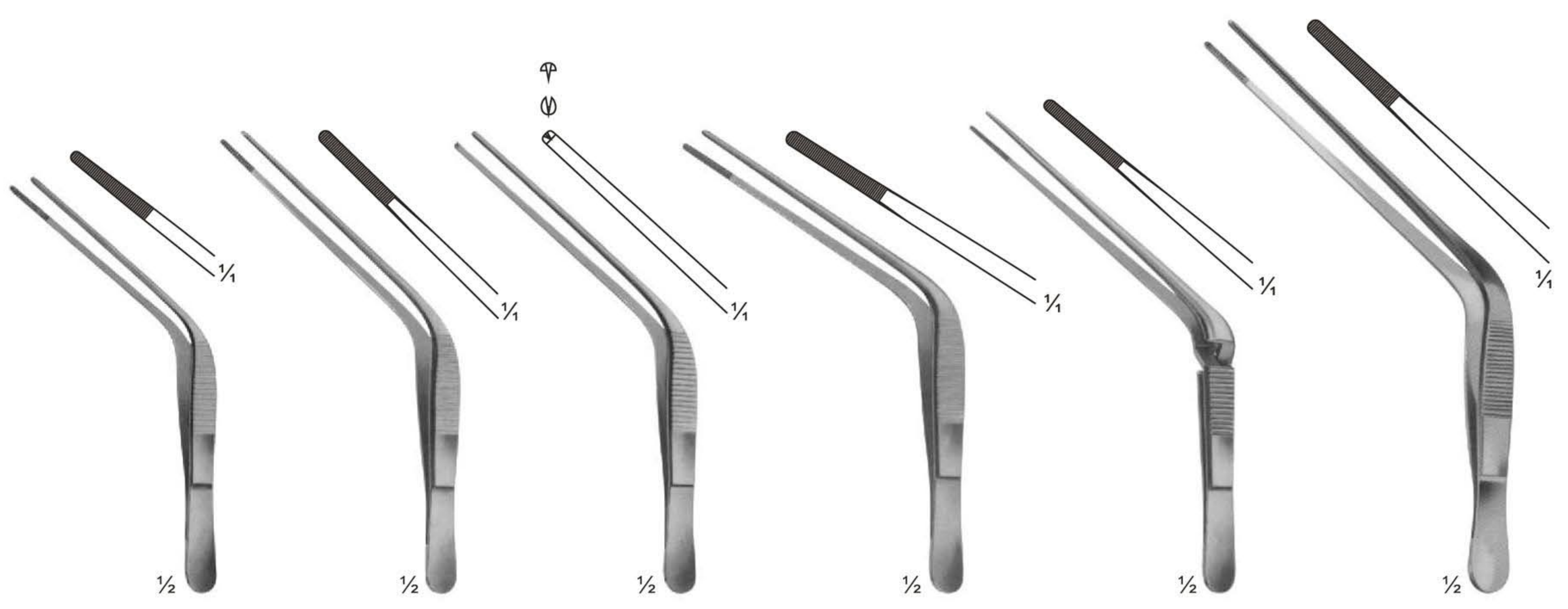

**04-239**  
 TROELTSCH  
 100 mm

**04-240**  
 TROELTSCH  
 115 mm

**04-241**  
 TROELTSCH  
 1X2 teeth  
 115 mm

**04-242**  
 WILDE  
 115 mm

**04-243**  
 TROELTSCH  
 Cross action  
 120 mm

**04-244**  
 TROELTSCH  
 140 mm



# Delicate Tissue Forceps

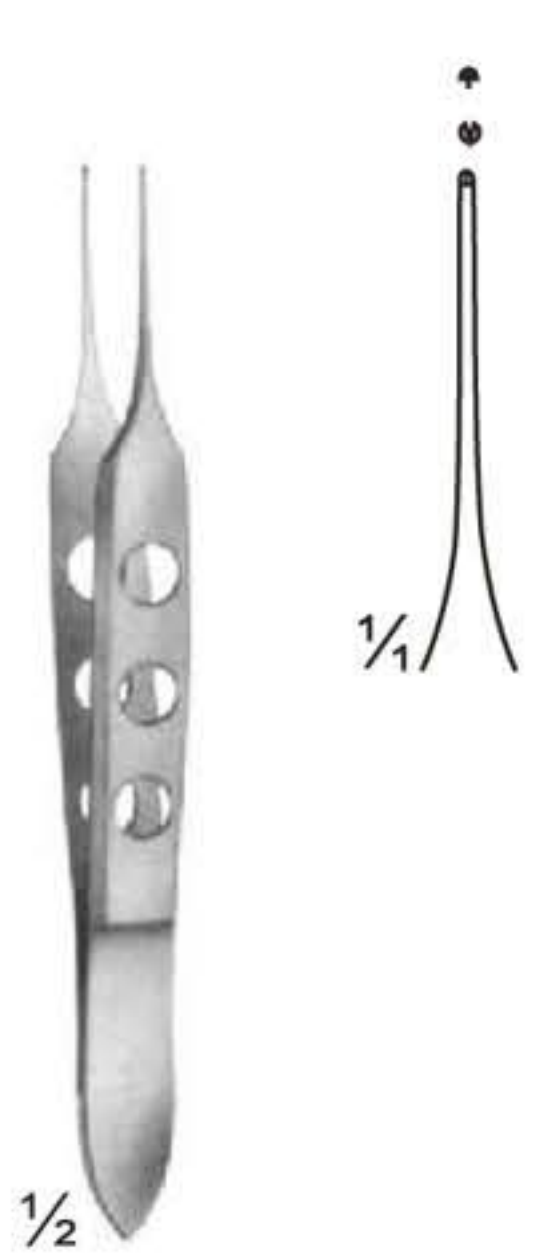

**04-245**  
BISHOP-HARMON  
85 mm

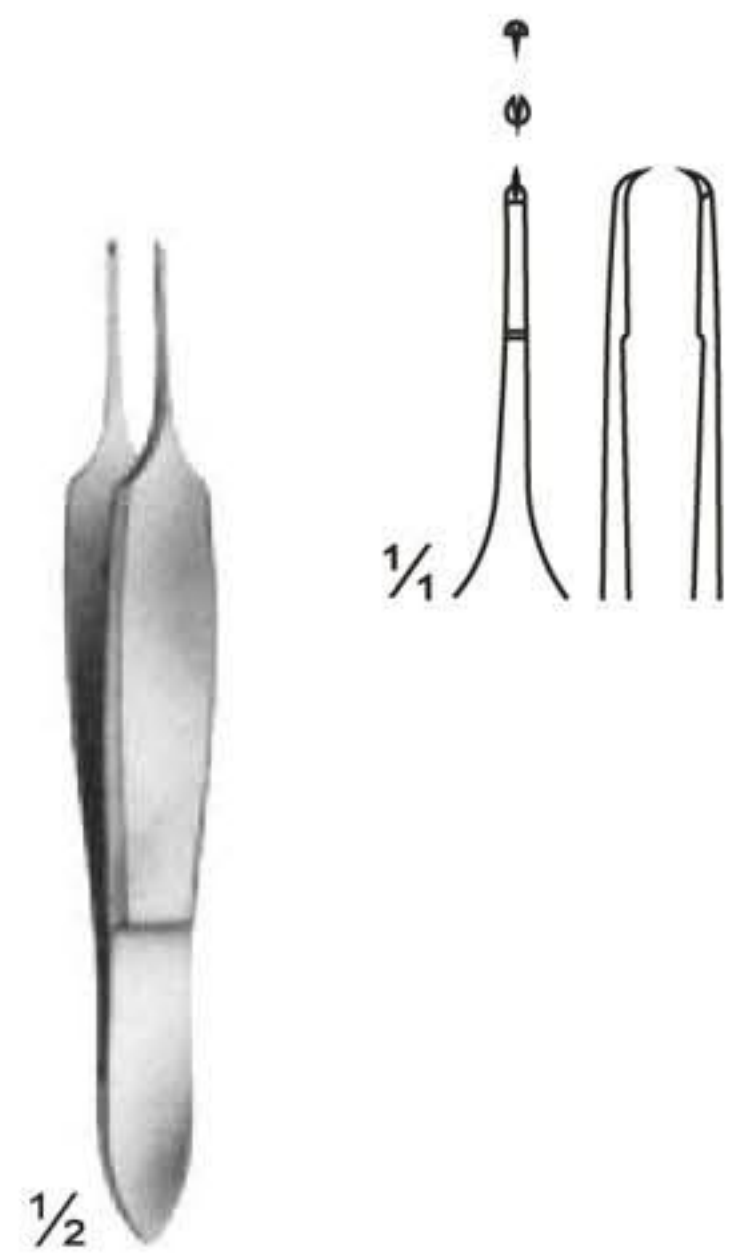

**04-246**  
ST.MARTIN  
80 mm

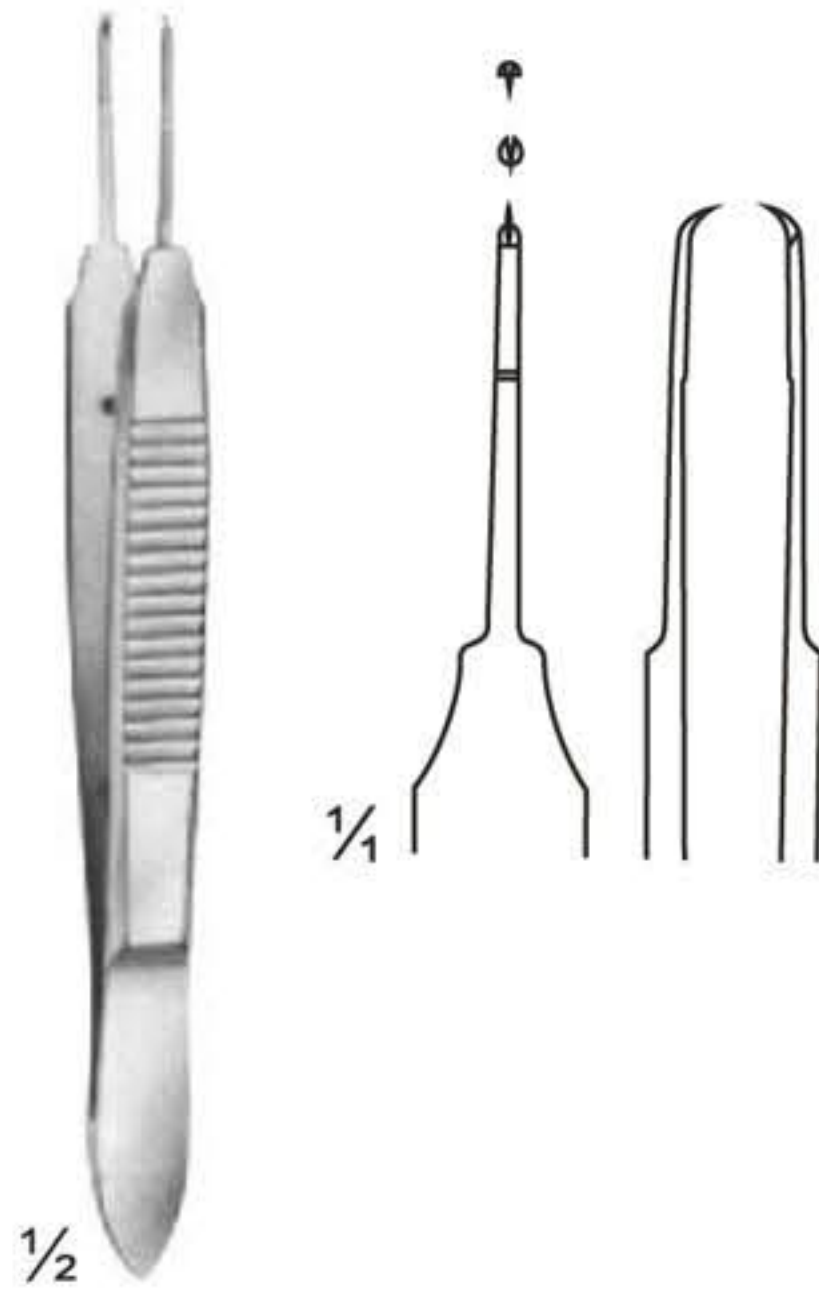

**04-247**  
CASTROVIEJO  
teeth 0.9 mm  
100 mm

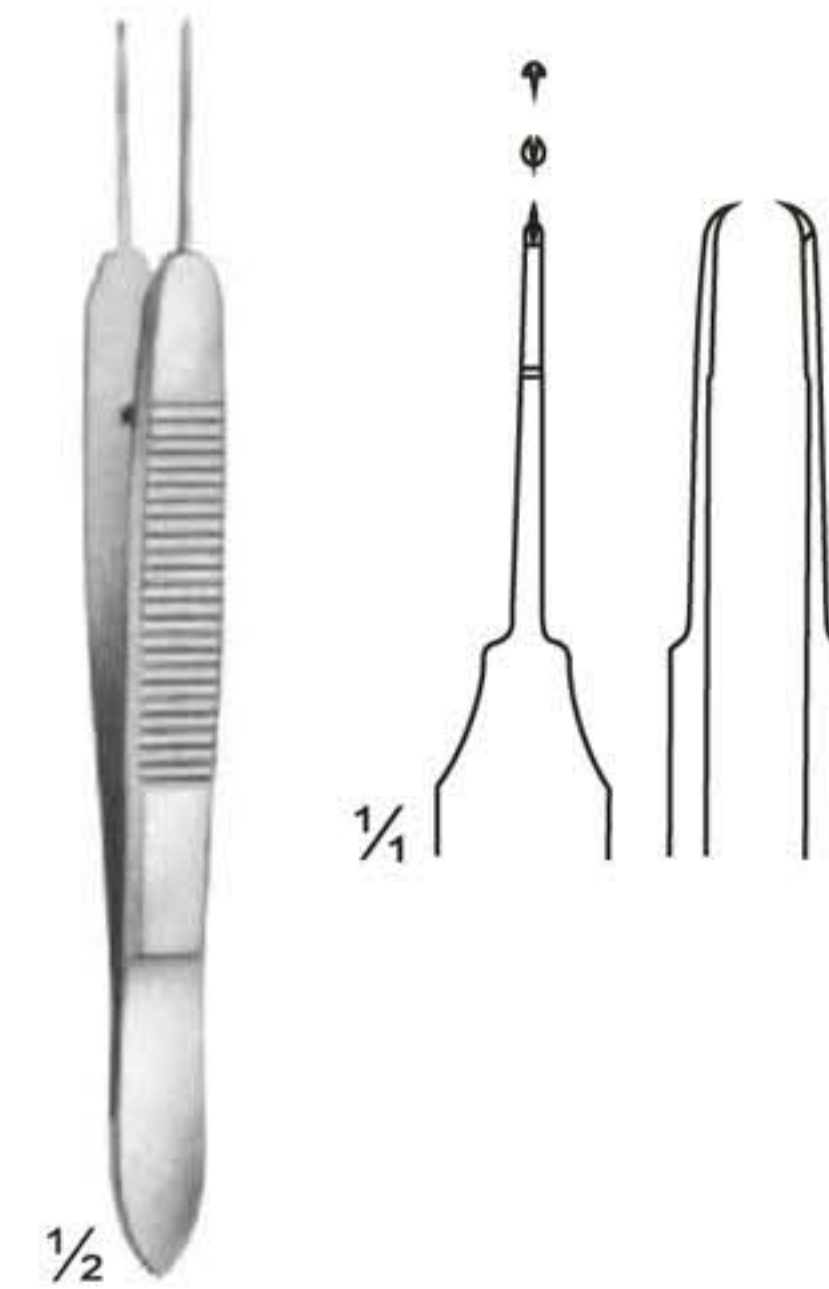

**04-248**  
CASTROVIEJO  
teeth 0.5 mm  
100 mm

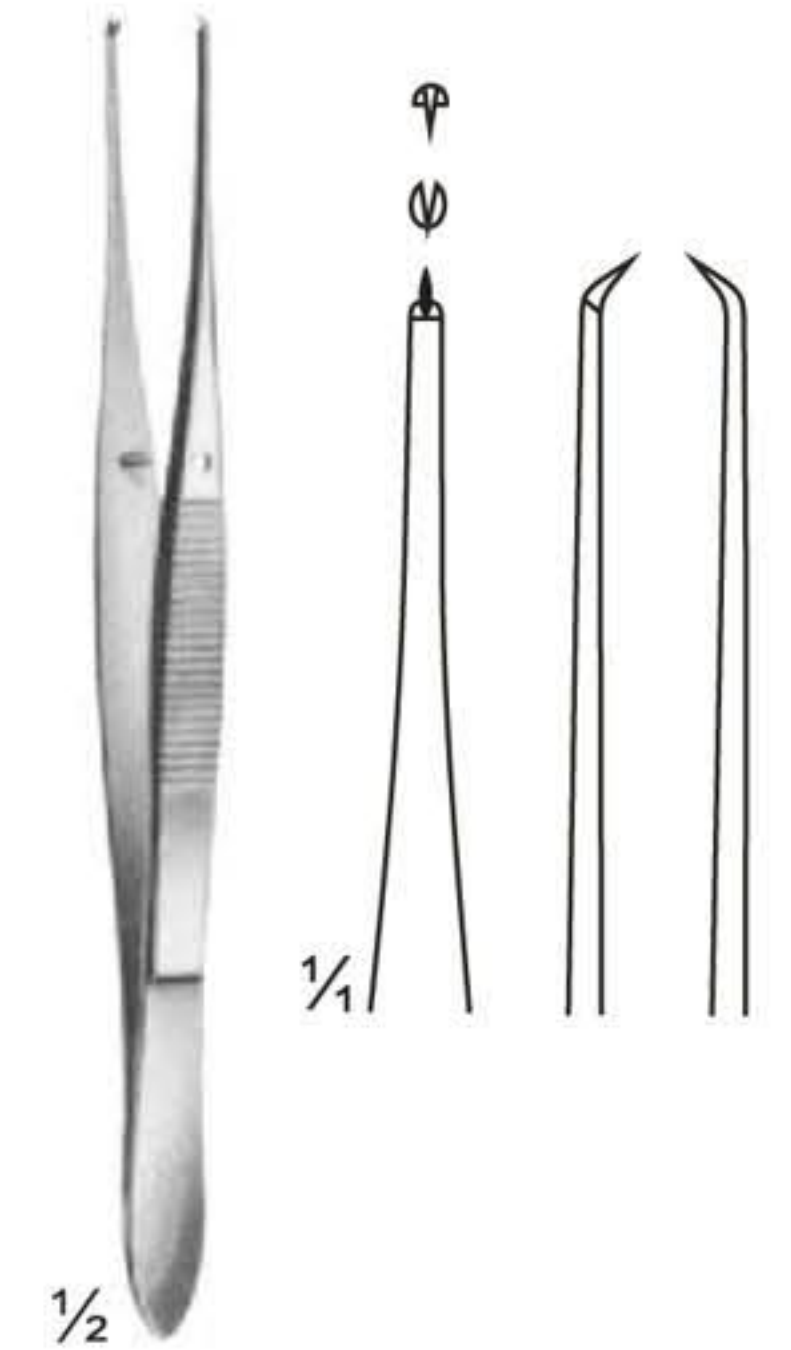

**04-249**  
ELSCHING  
110 mm

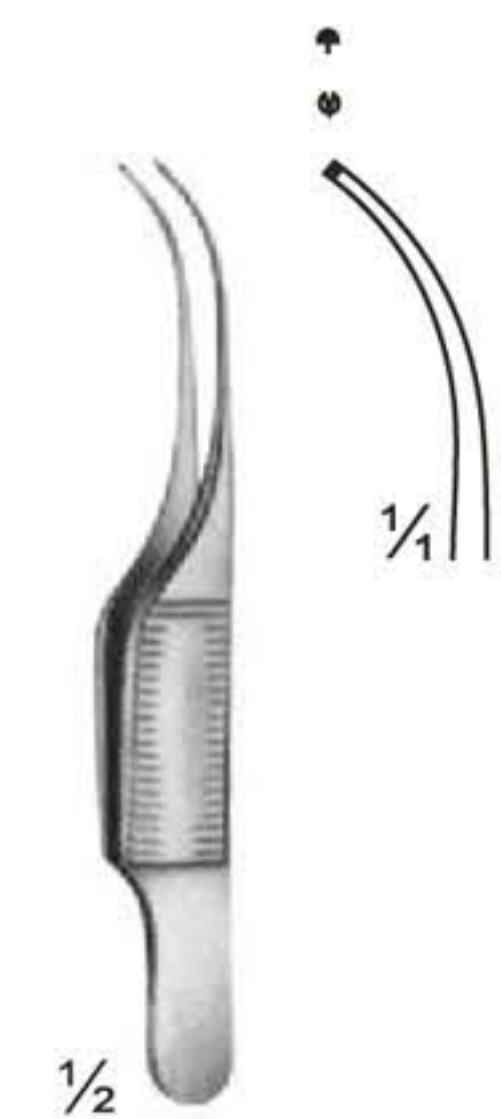

**04-250**  
GILL  
75 mm

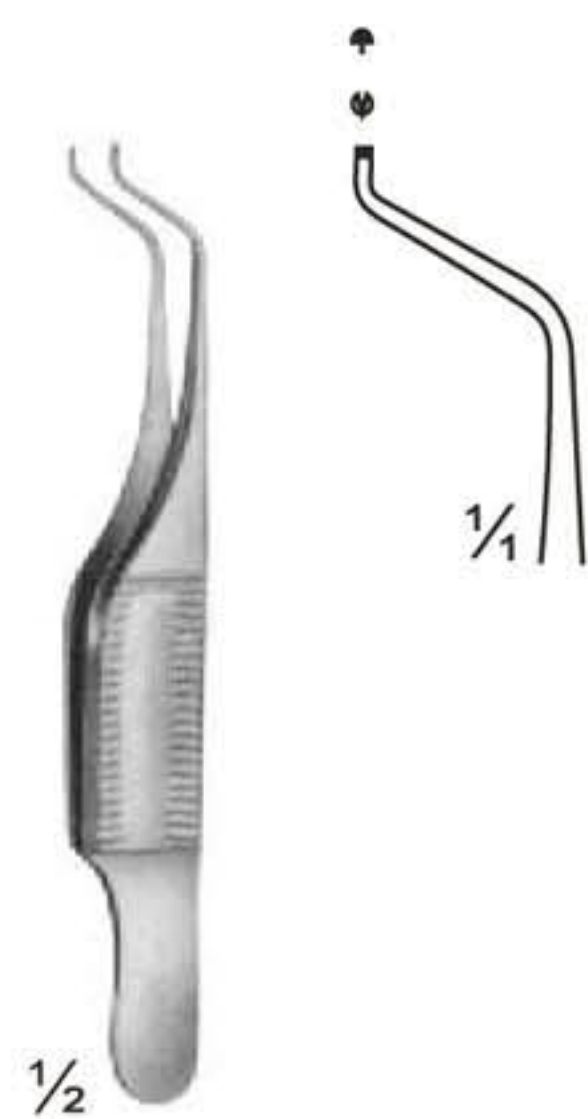

**04-251**  
GILL - HESS  
75 mm

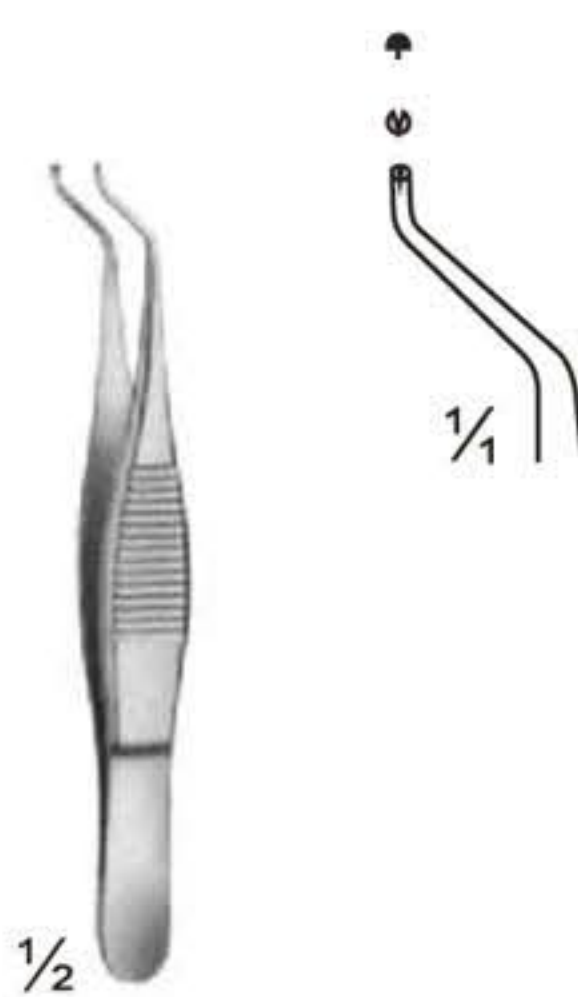

**04-252**  
HESS  
70 mm

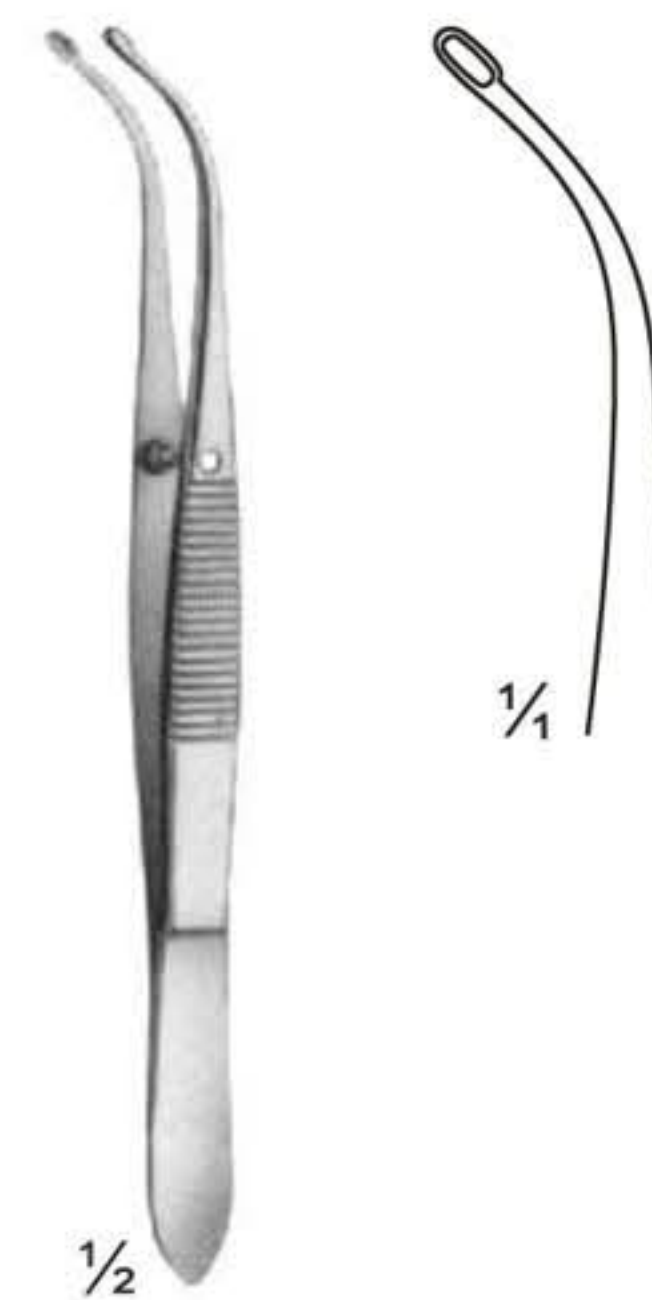

**04-253**  
ARRUGA  
100 mm

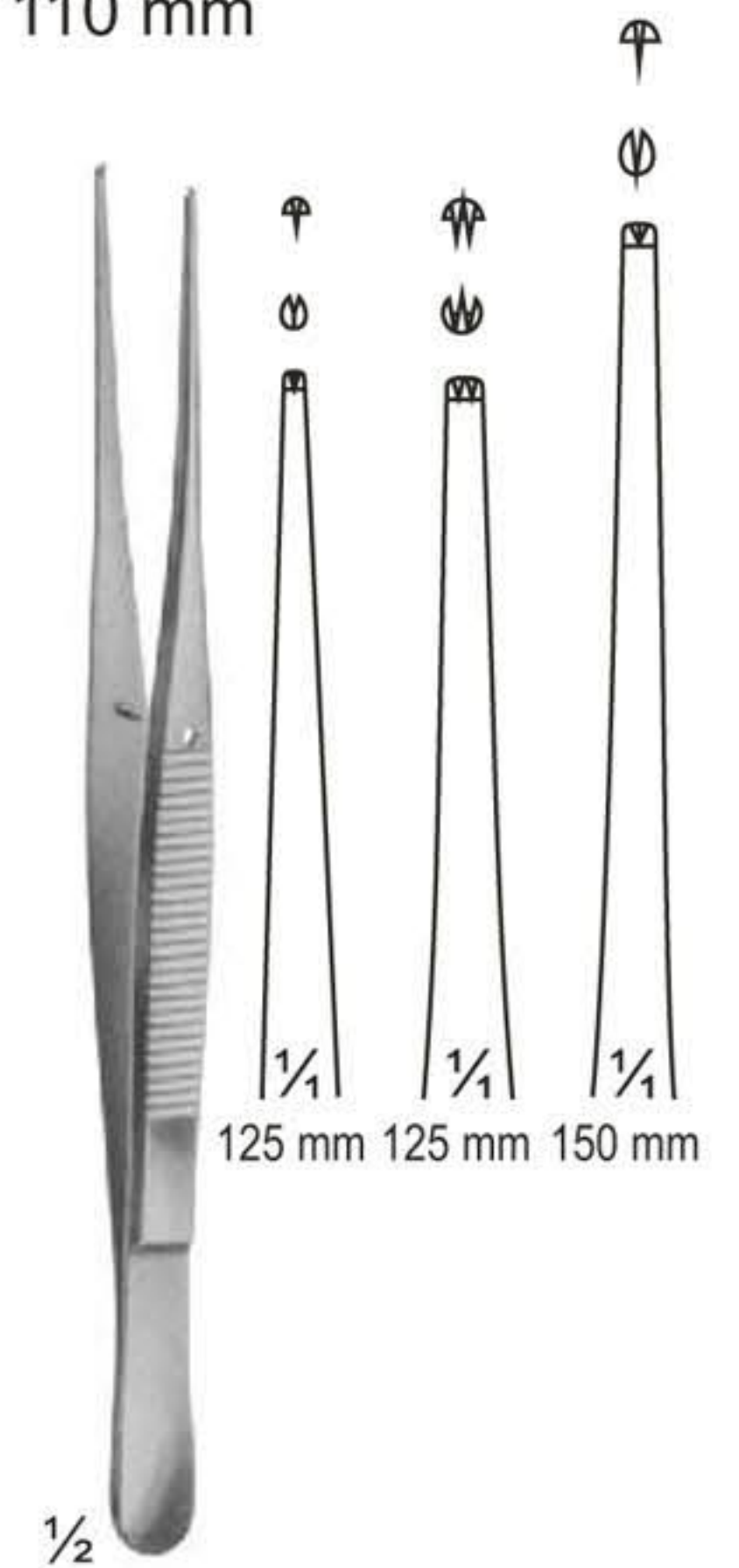

**04-254**  
SEMKEN

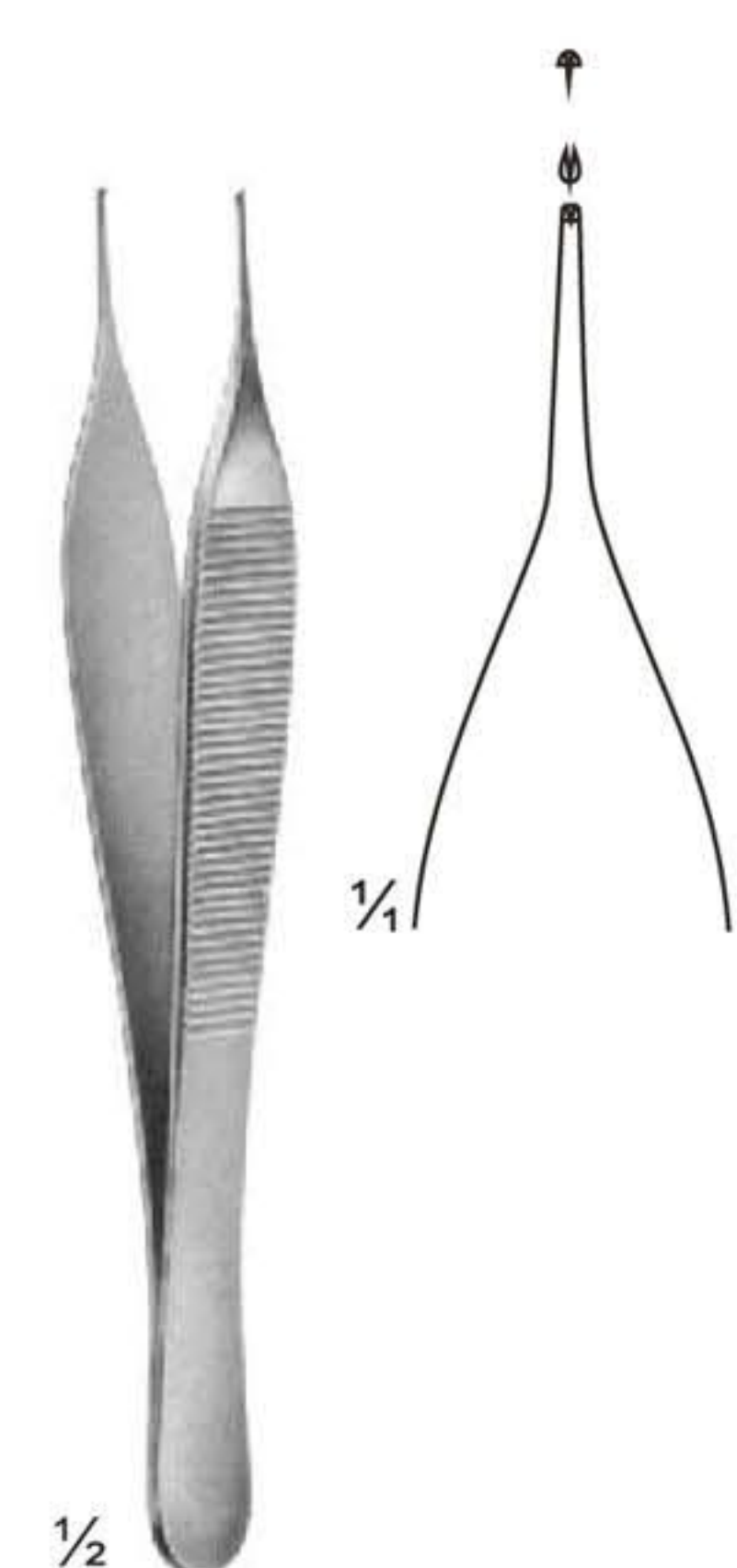

**04-255**  
MICRO-ADSON  
120 mm

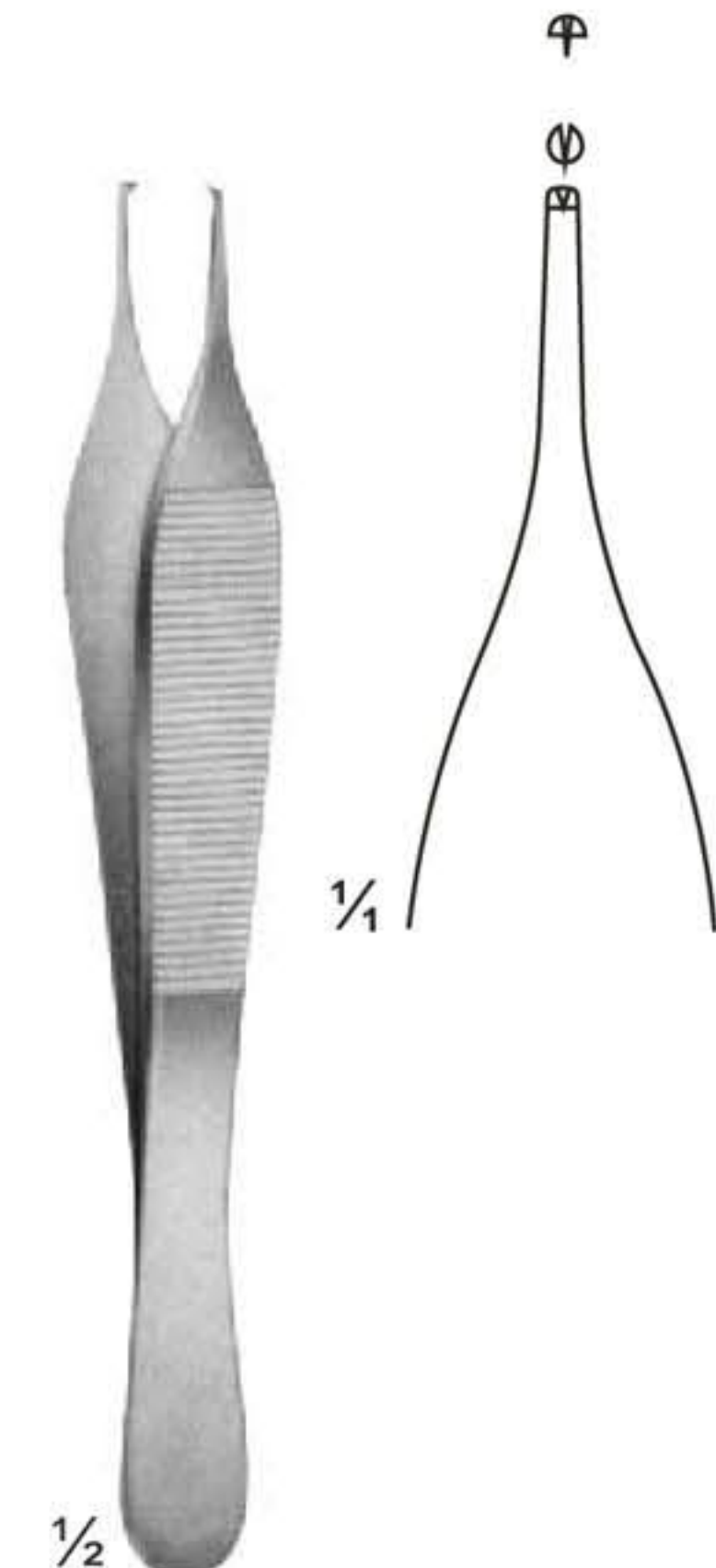

**04-256**  
ADSON  
120 mm

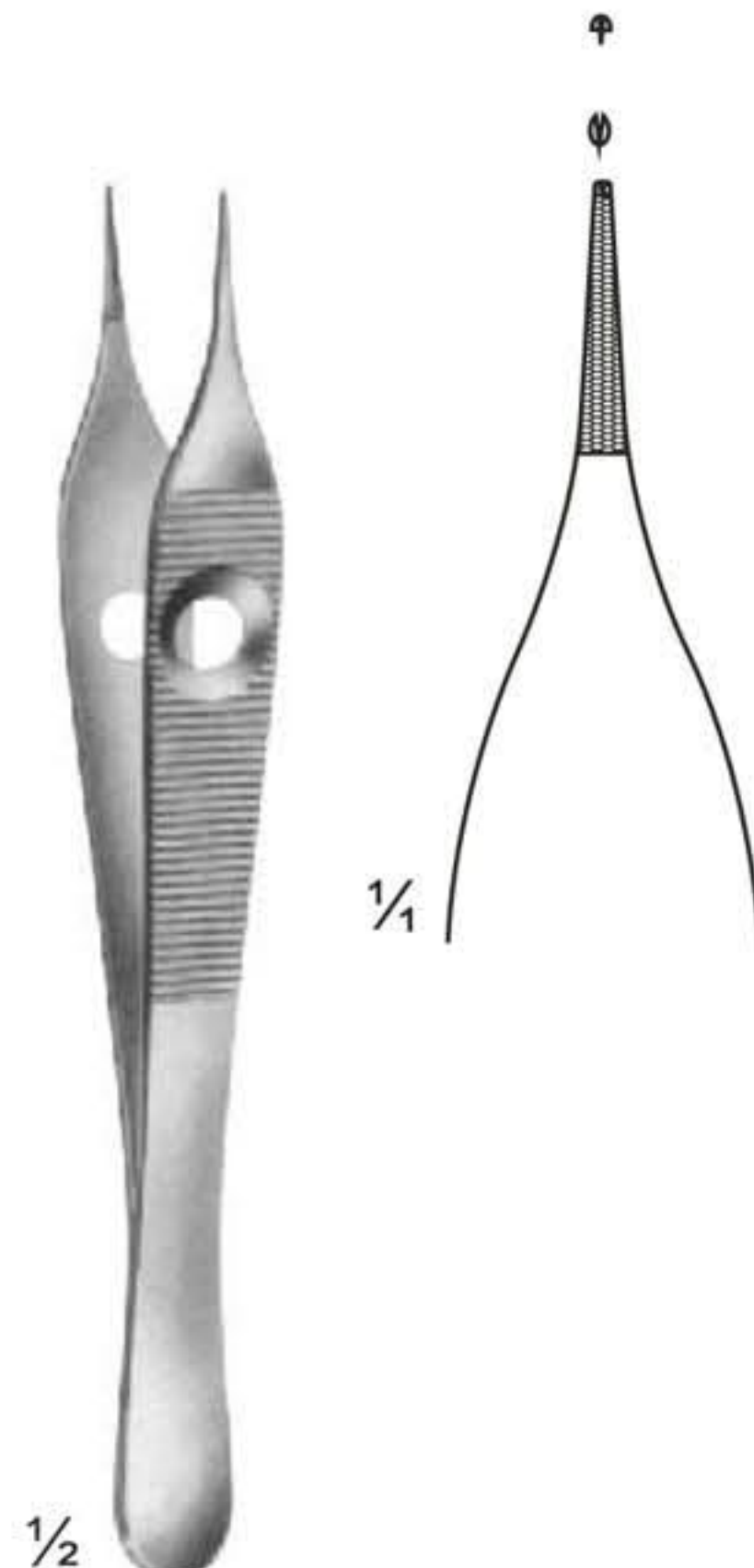

**04-257**  
ADSON  
120 mm



**04-258**  
ADSON  
120 mm

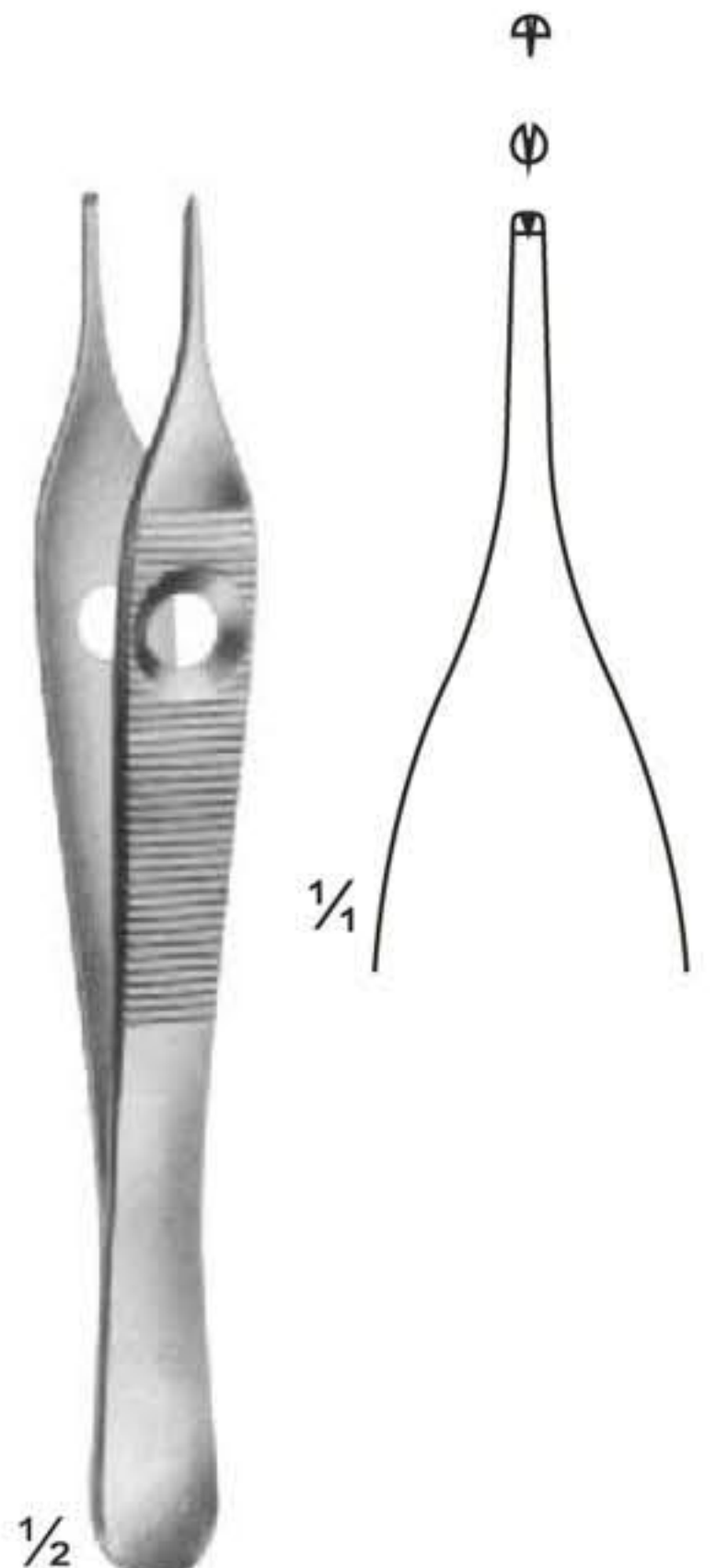

**04-259**  
ADSON  
150 mm



# Tissue Forceps

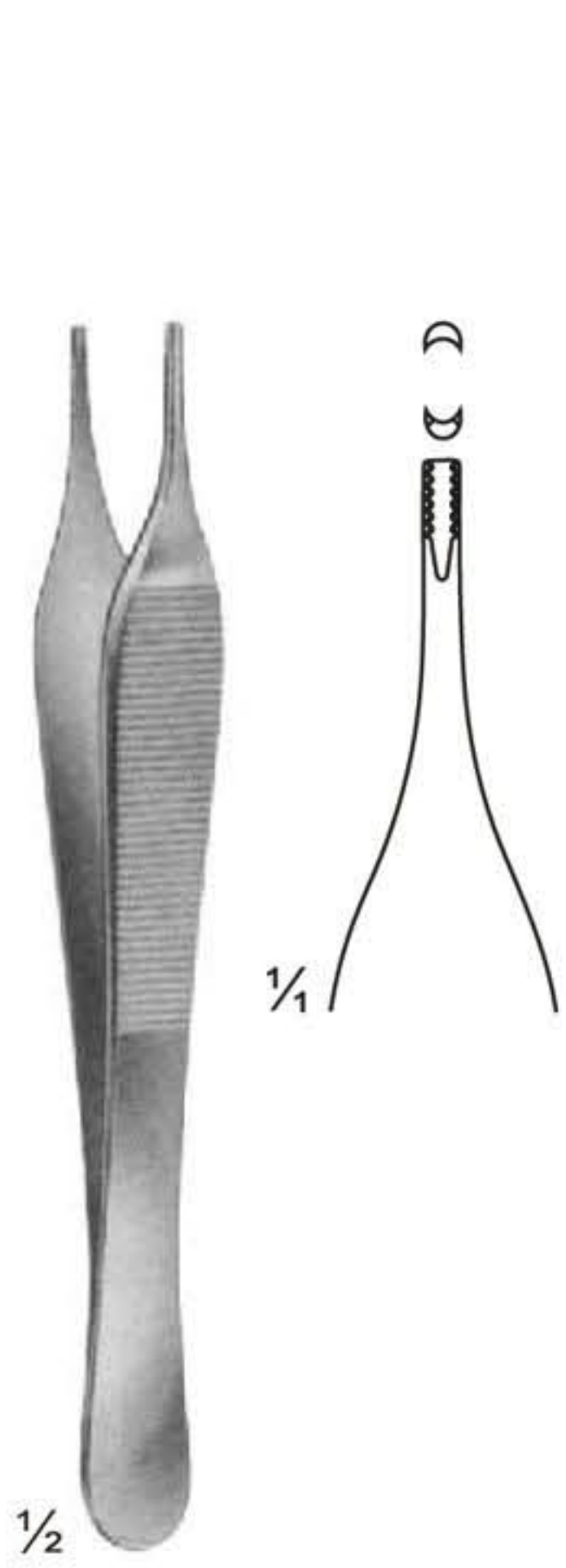

**04-260**  
**ADSON - BROWN**  
Non-traumatic  
120 mm

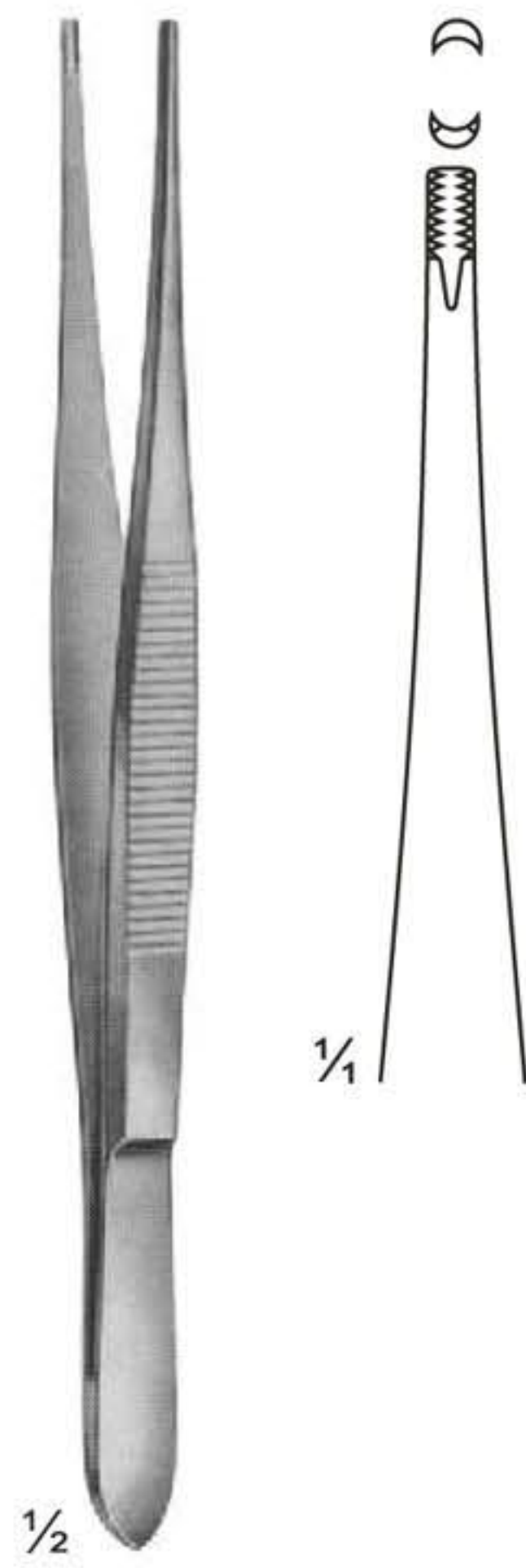

**04-261**  
**BROWN**  
120 mm

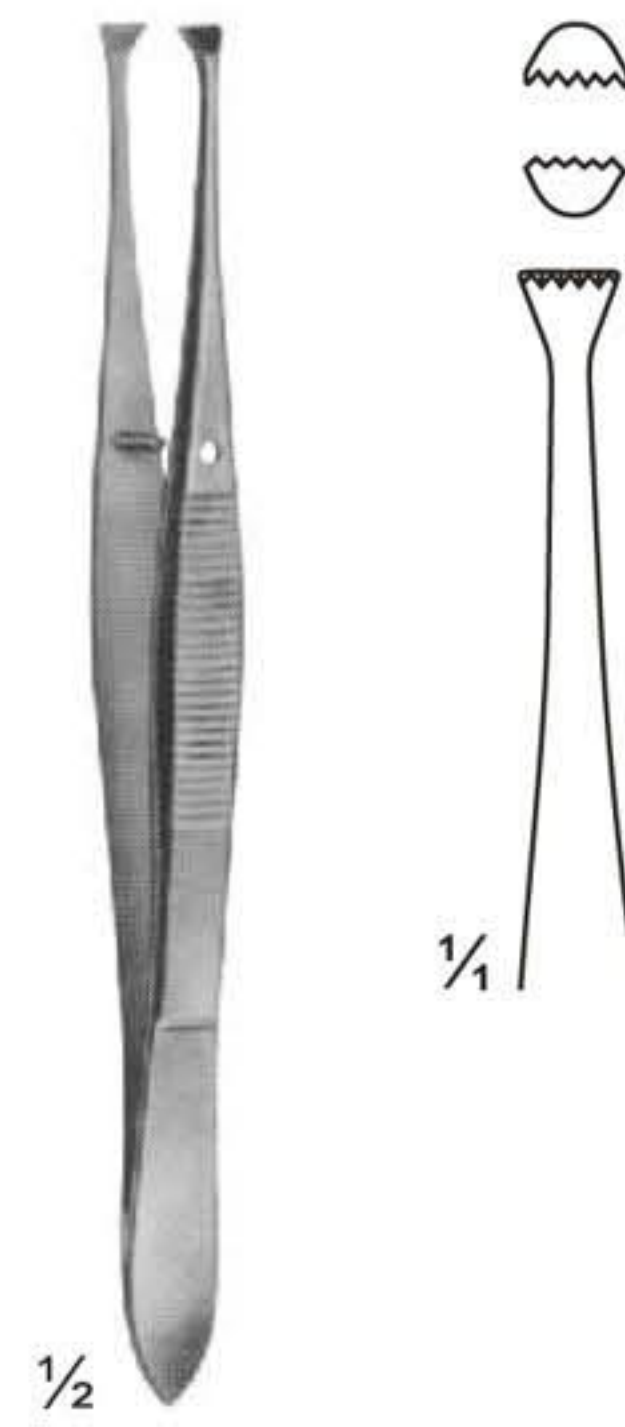

**04-262**  
**GRAEFE**  
110 mm

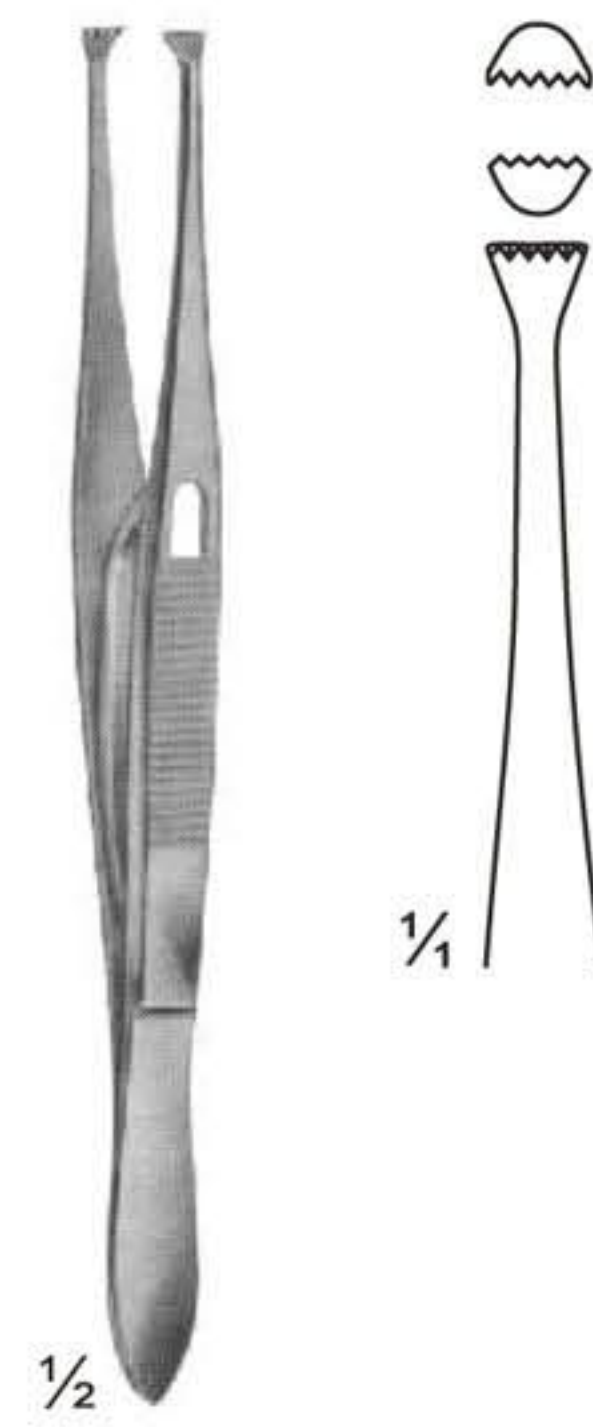

**04-263**  
**GRAEFE**  
With Catch  
110 mm

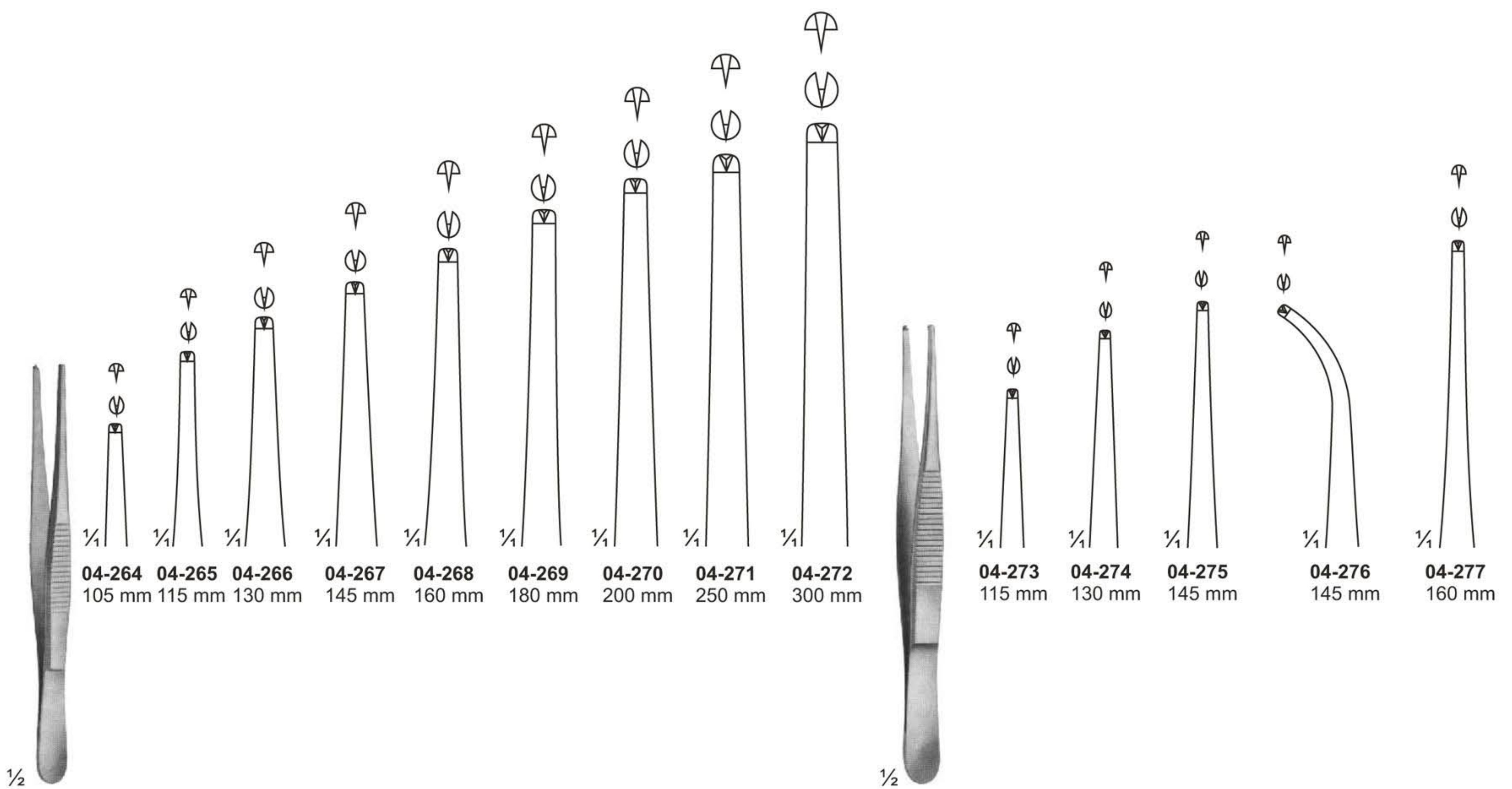

**04-264 - 272**  
**STANDARD**

**04-273 - 277**  
**GRAEFE**  
110 mm



# Tissue Forceps

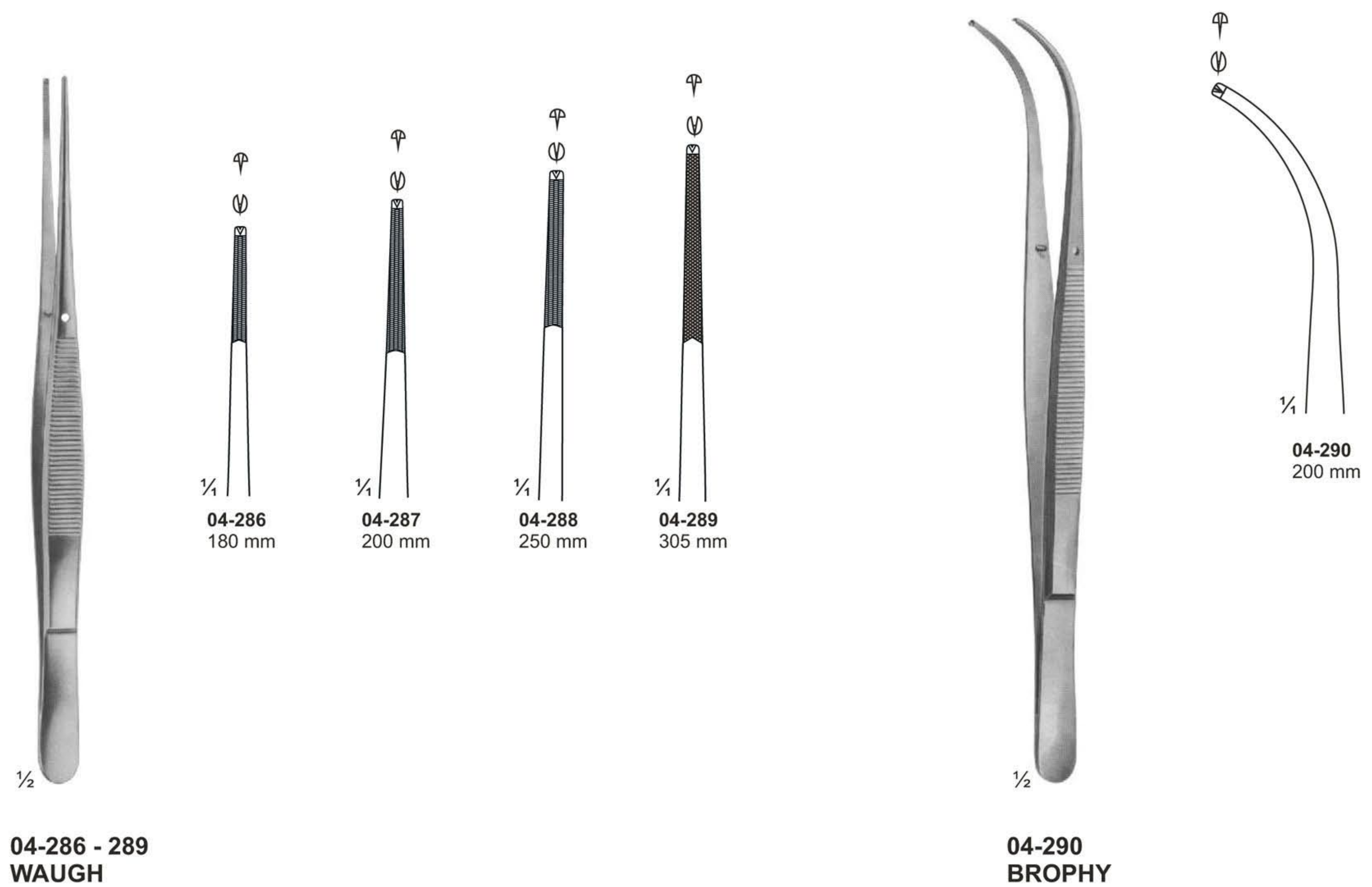
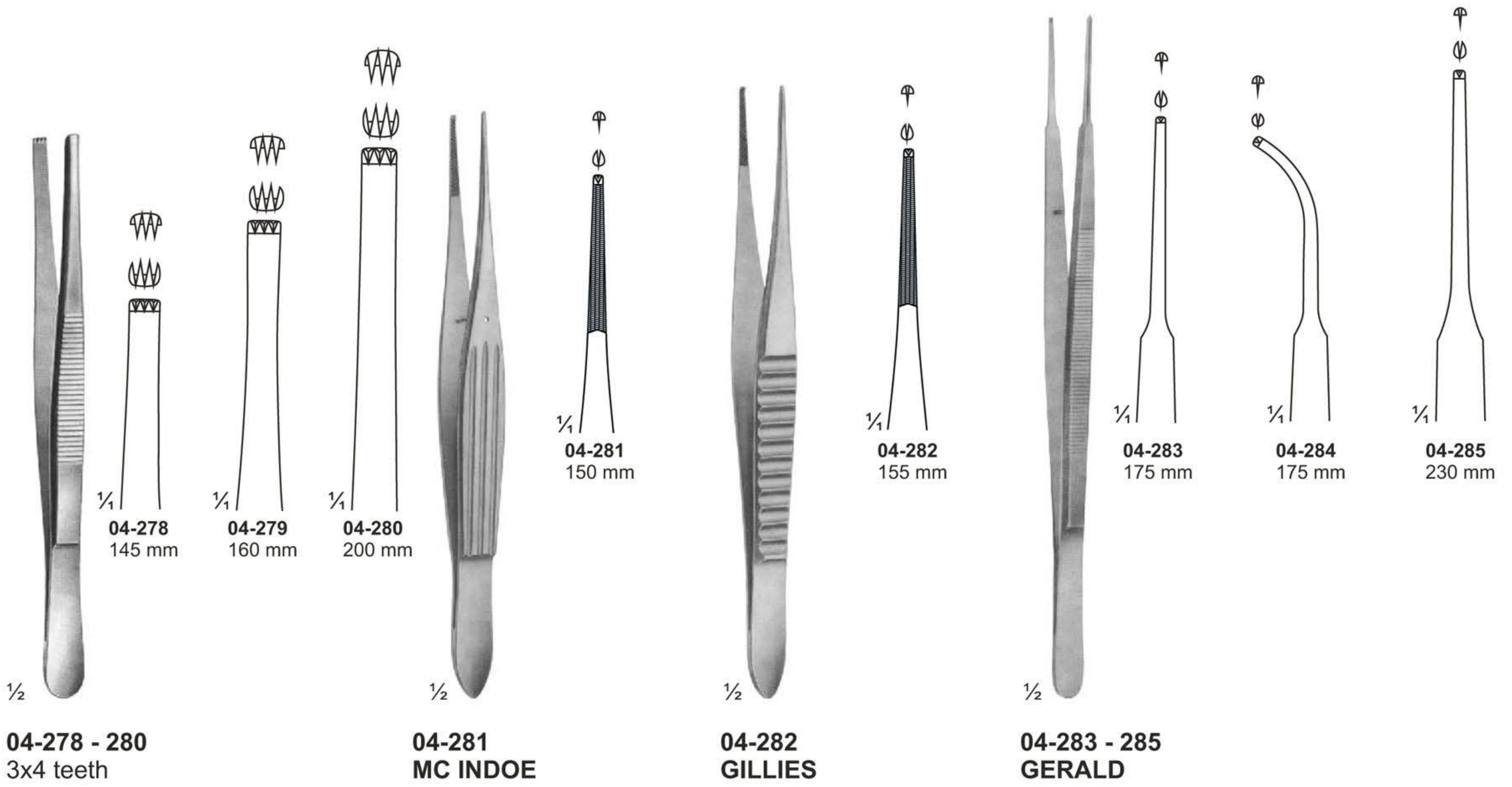



# Tissue Forceps, Lung Dissecting Forceps

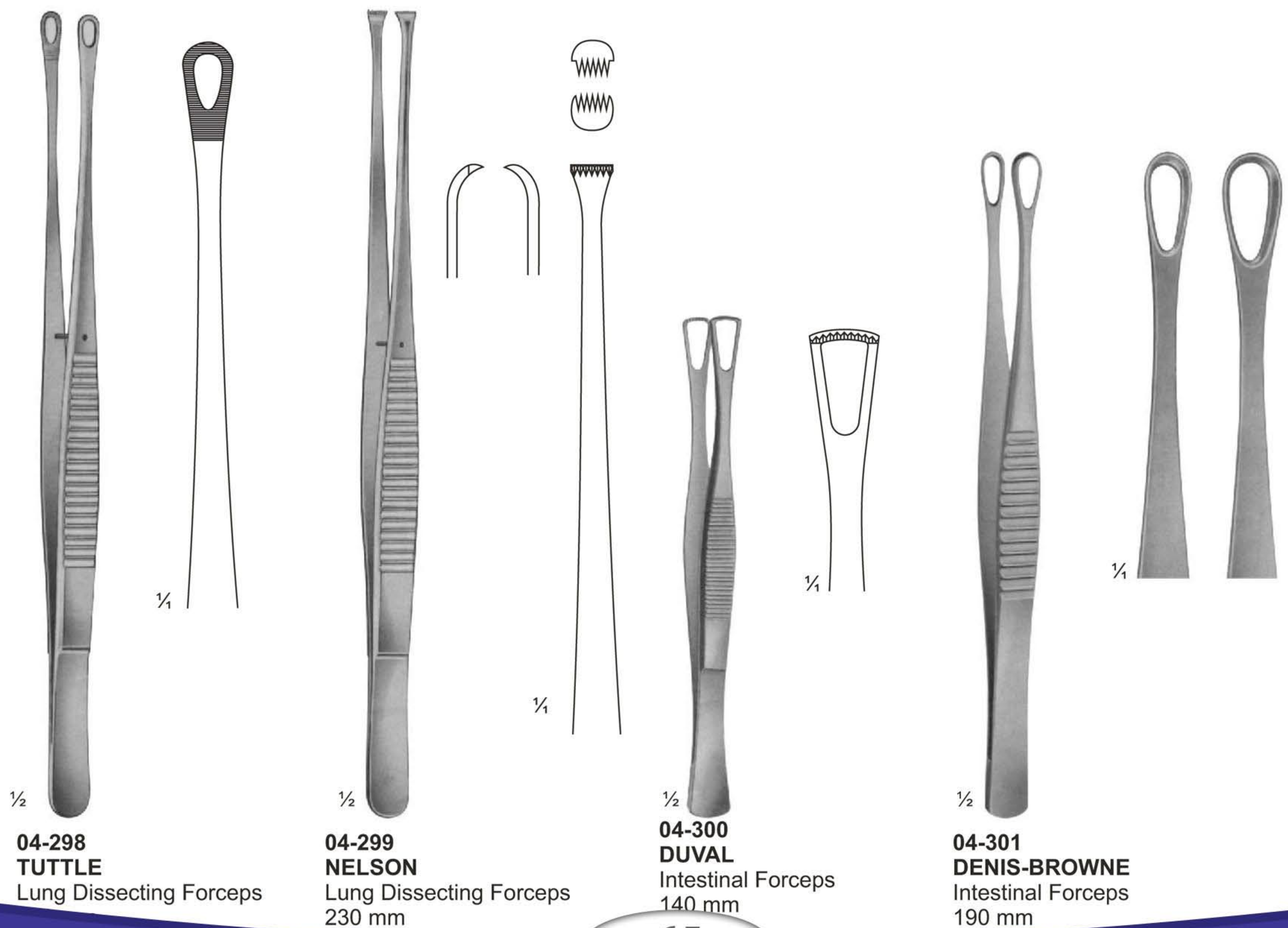
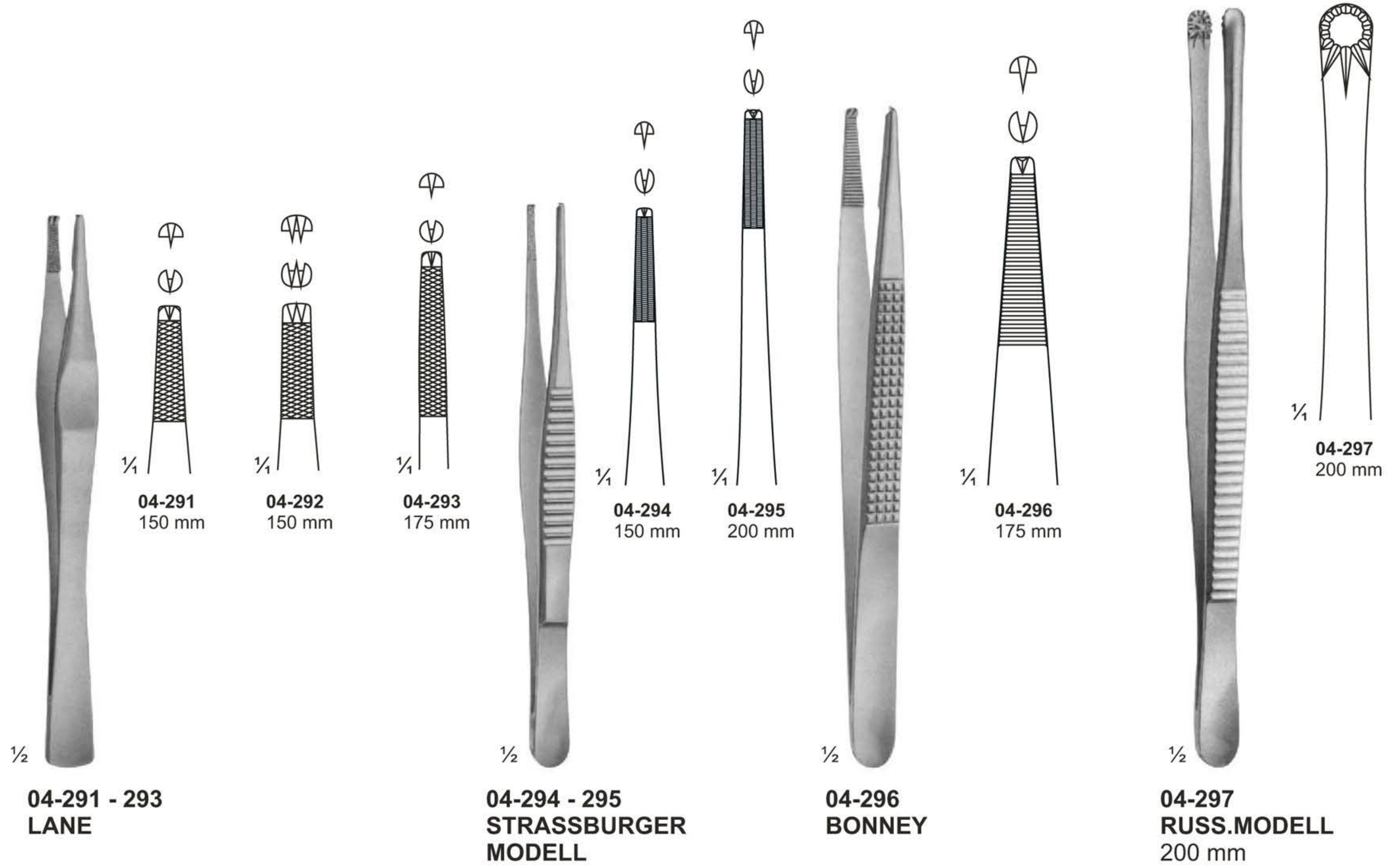



# Splinter and Cilia Forceps

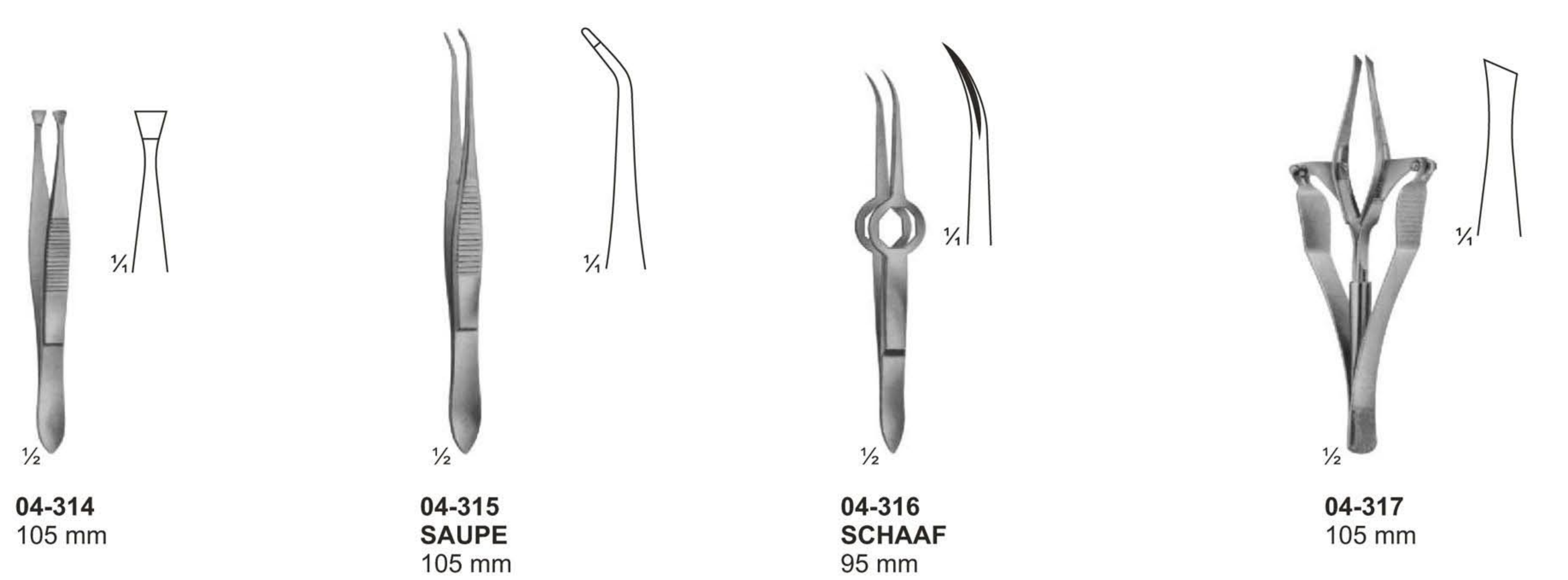
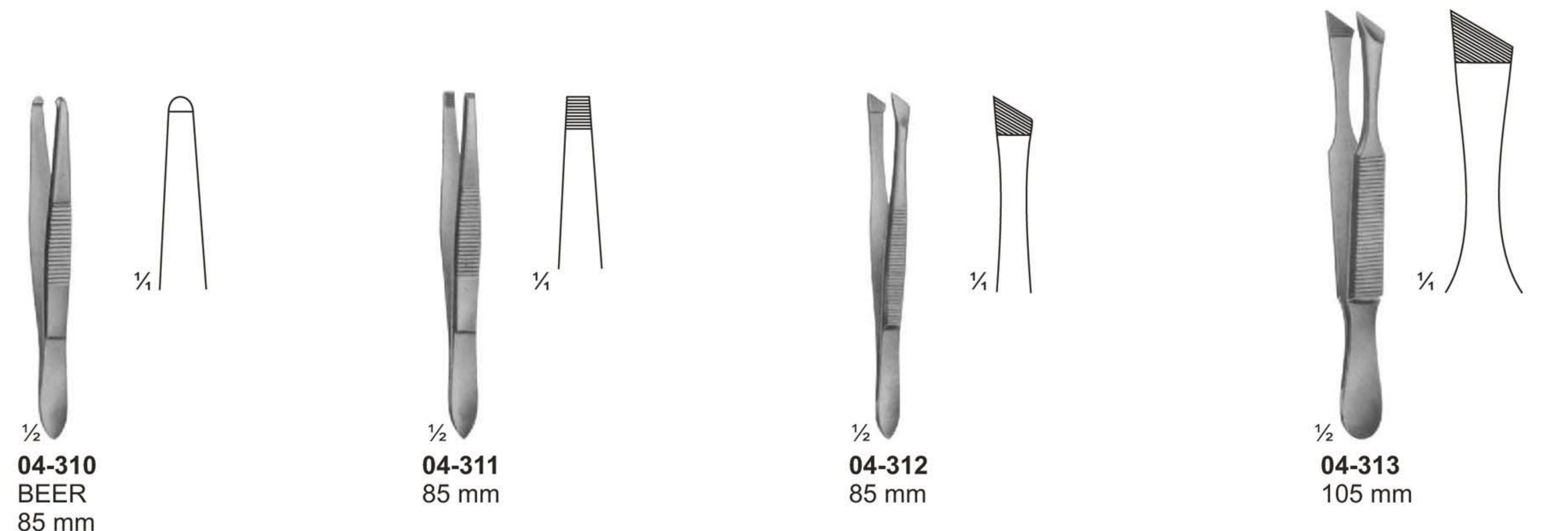
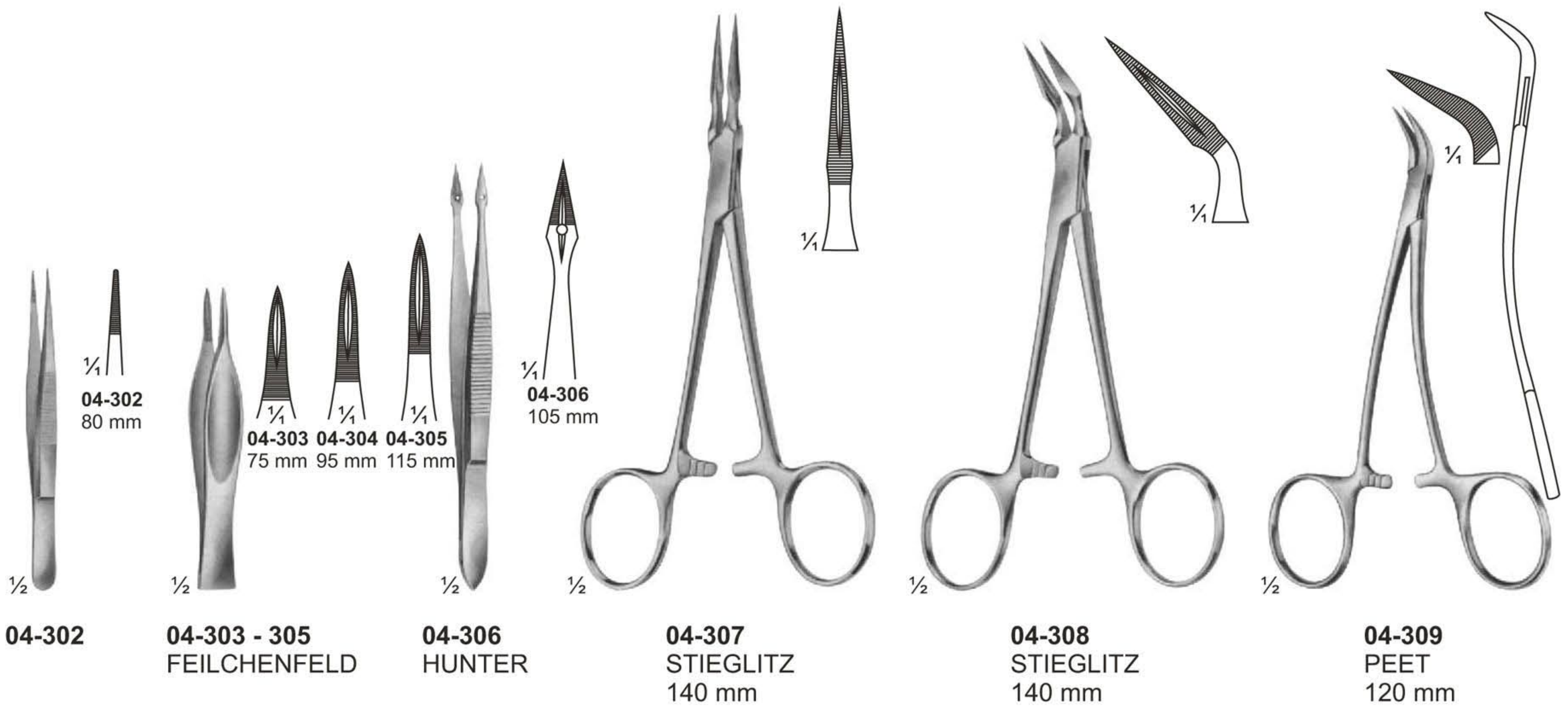



Sponge and Dressing Forceps

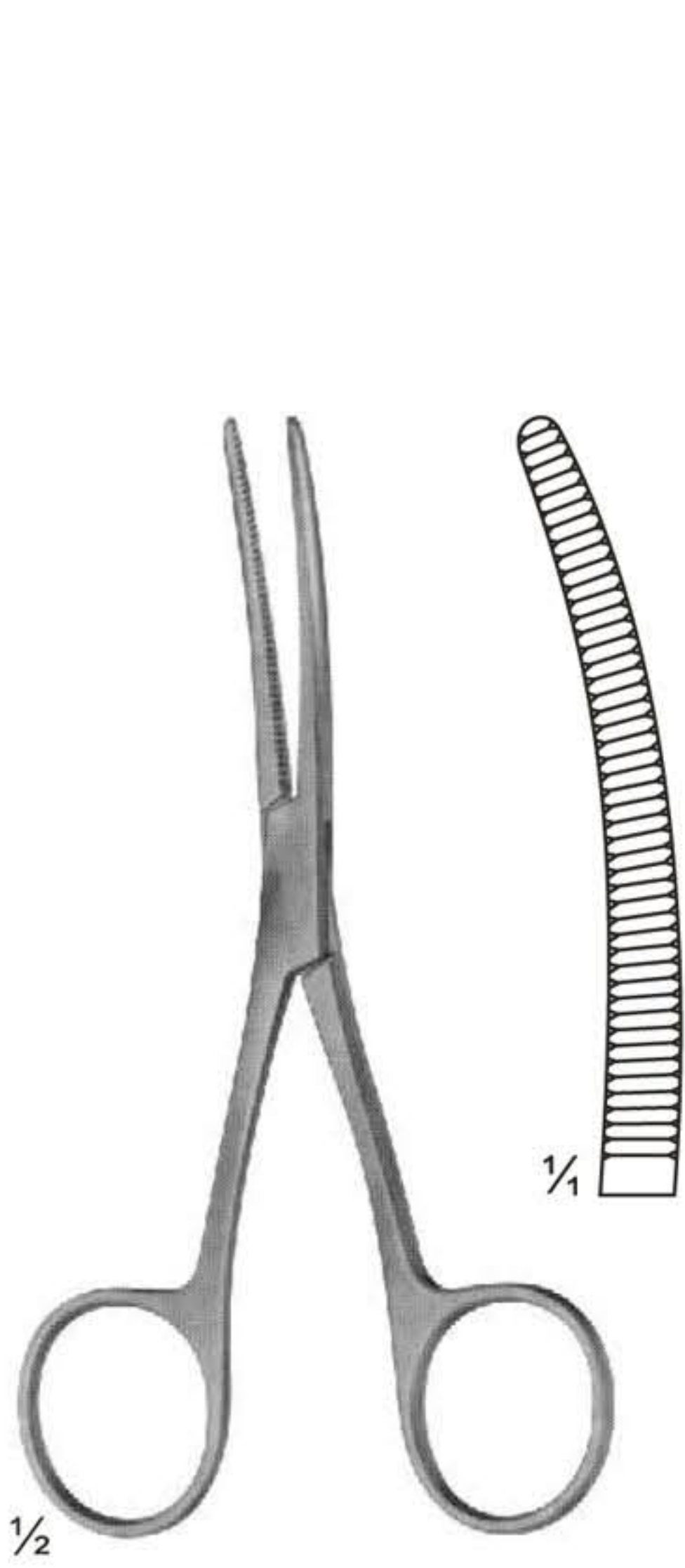

**04-318**  
BRYANT  
130 mm

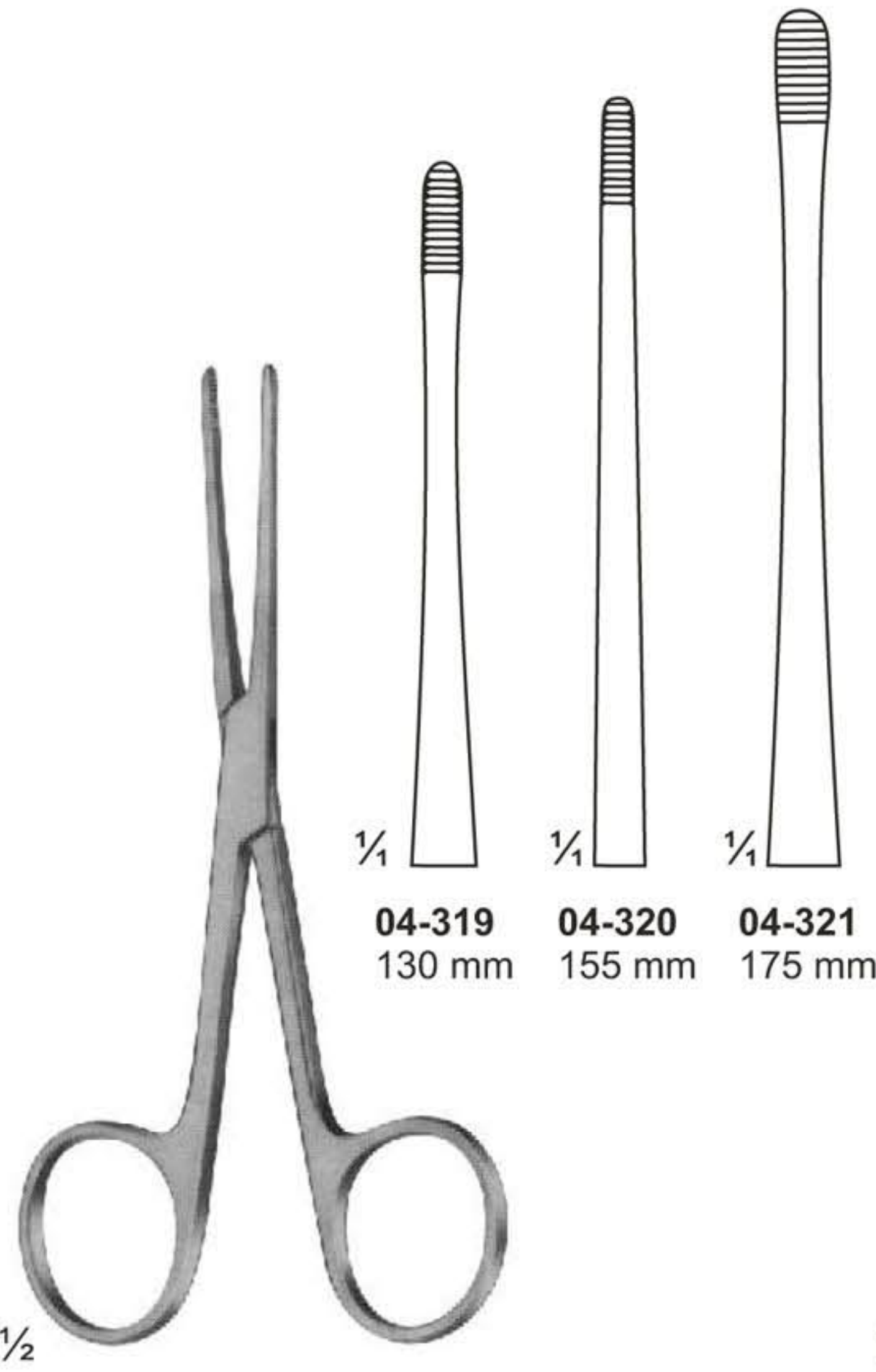

**04-319 - 321**  
LISTER  
Sinus Forceps

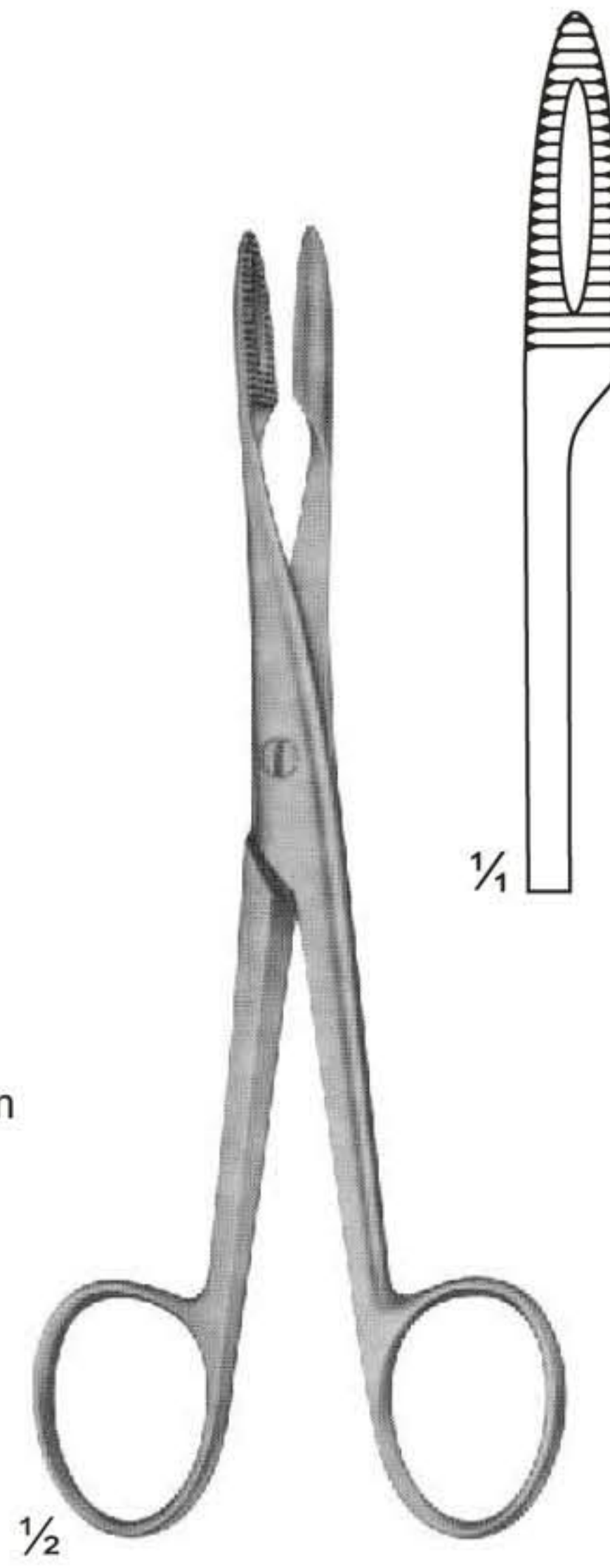

**04-322**  
Without Ratchet  
145 mm

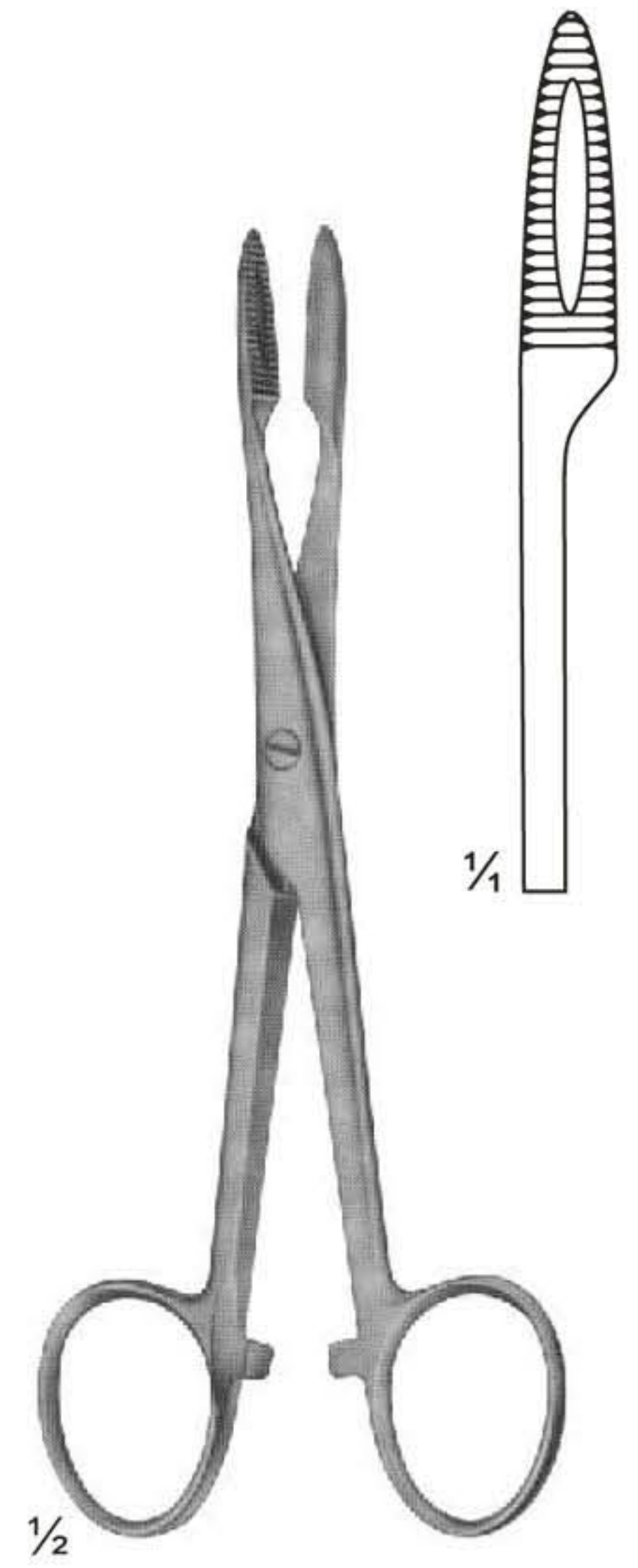

**04-323**  
With Ratchet  
145 mm

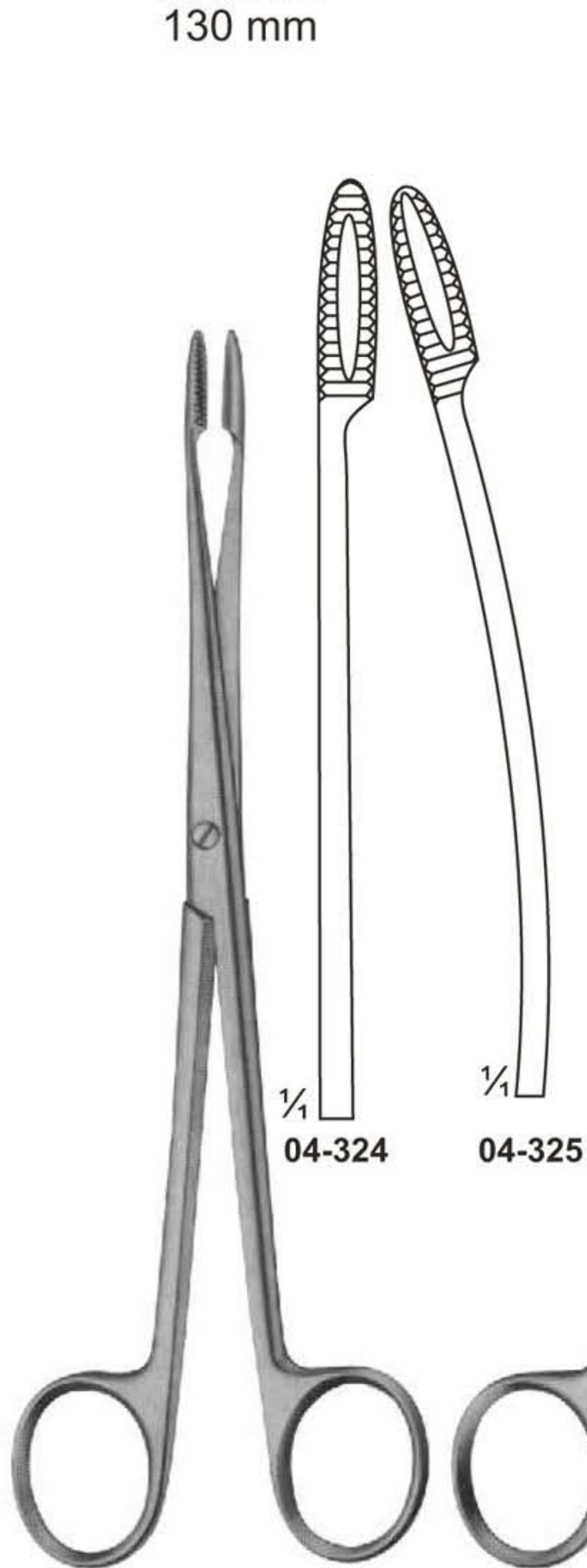

**04-324 - 325**  
GROSS  
Without Ratchet  
200 mm

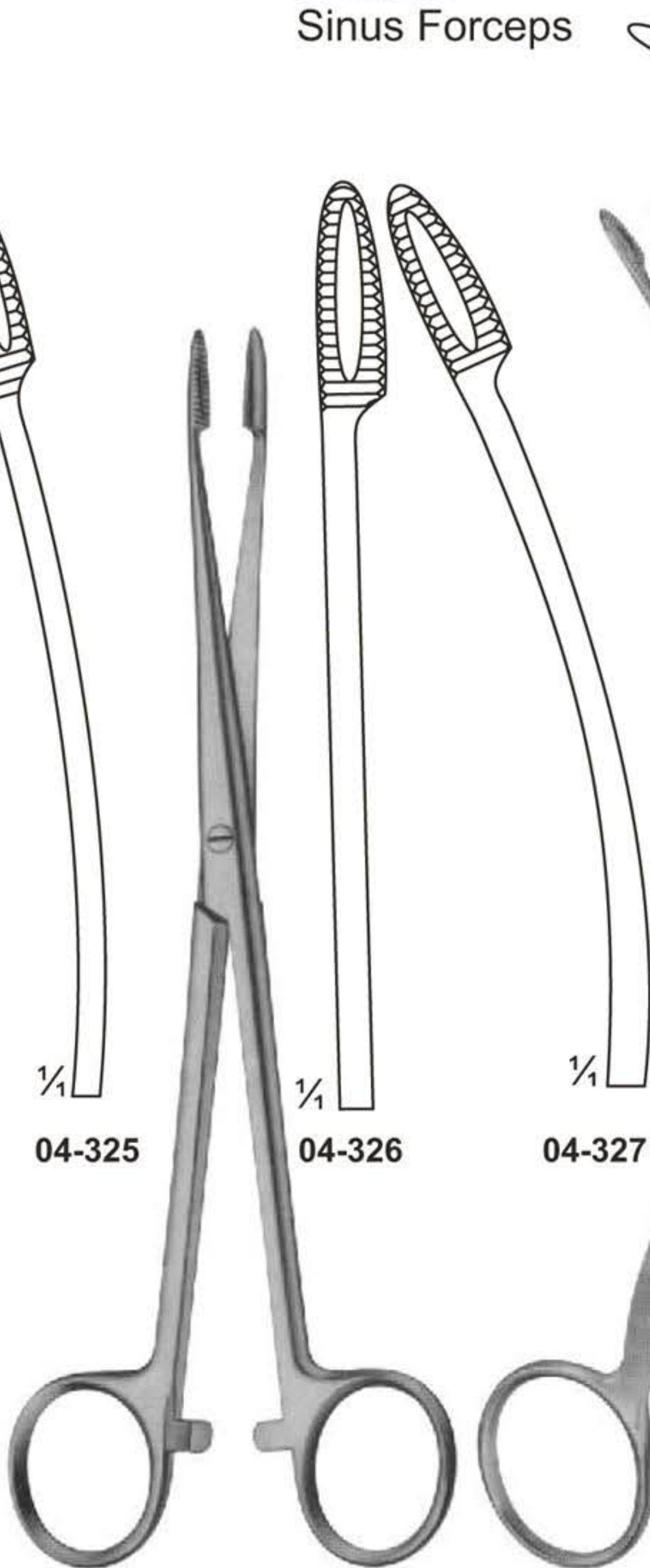

**04-326 - 327**  
GROSS  
With Ratchet  
180 mm

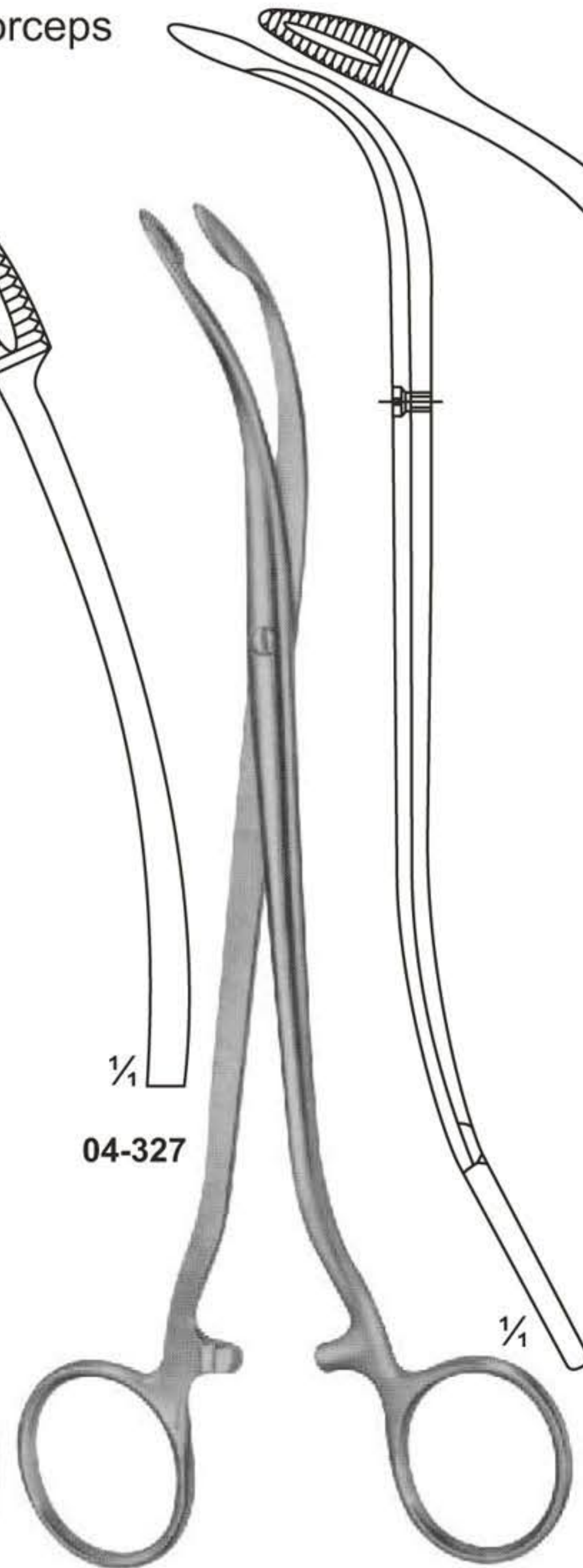

**04-328**  
DUPLAY  
190 mm

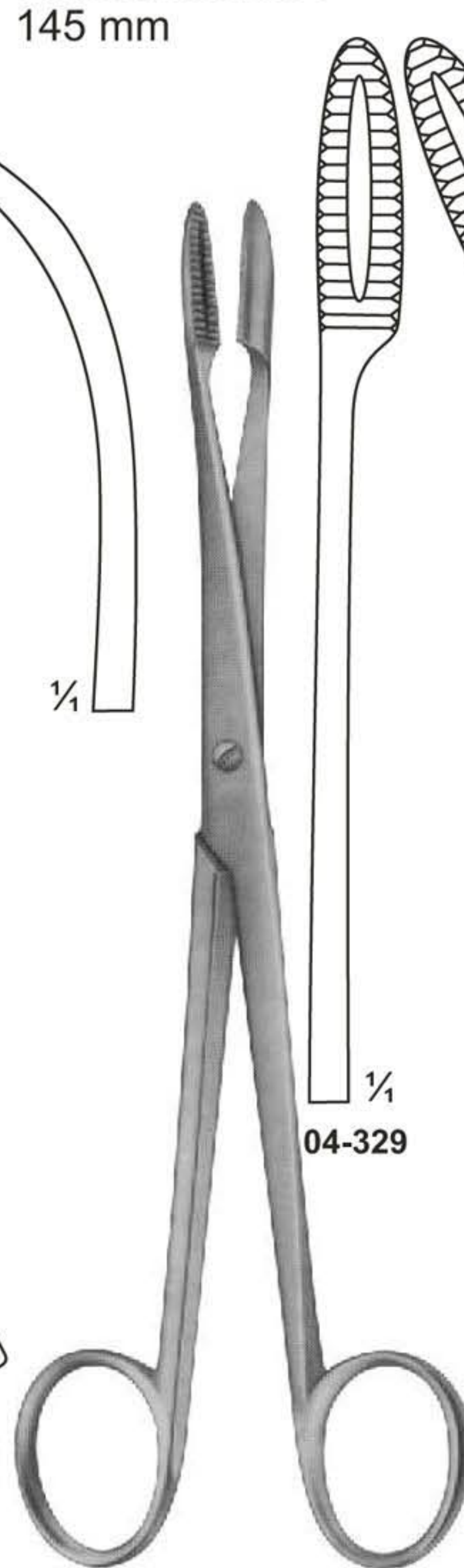

**04-329 - 330**  
GROSS  
Without Ratchet  
200 mm

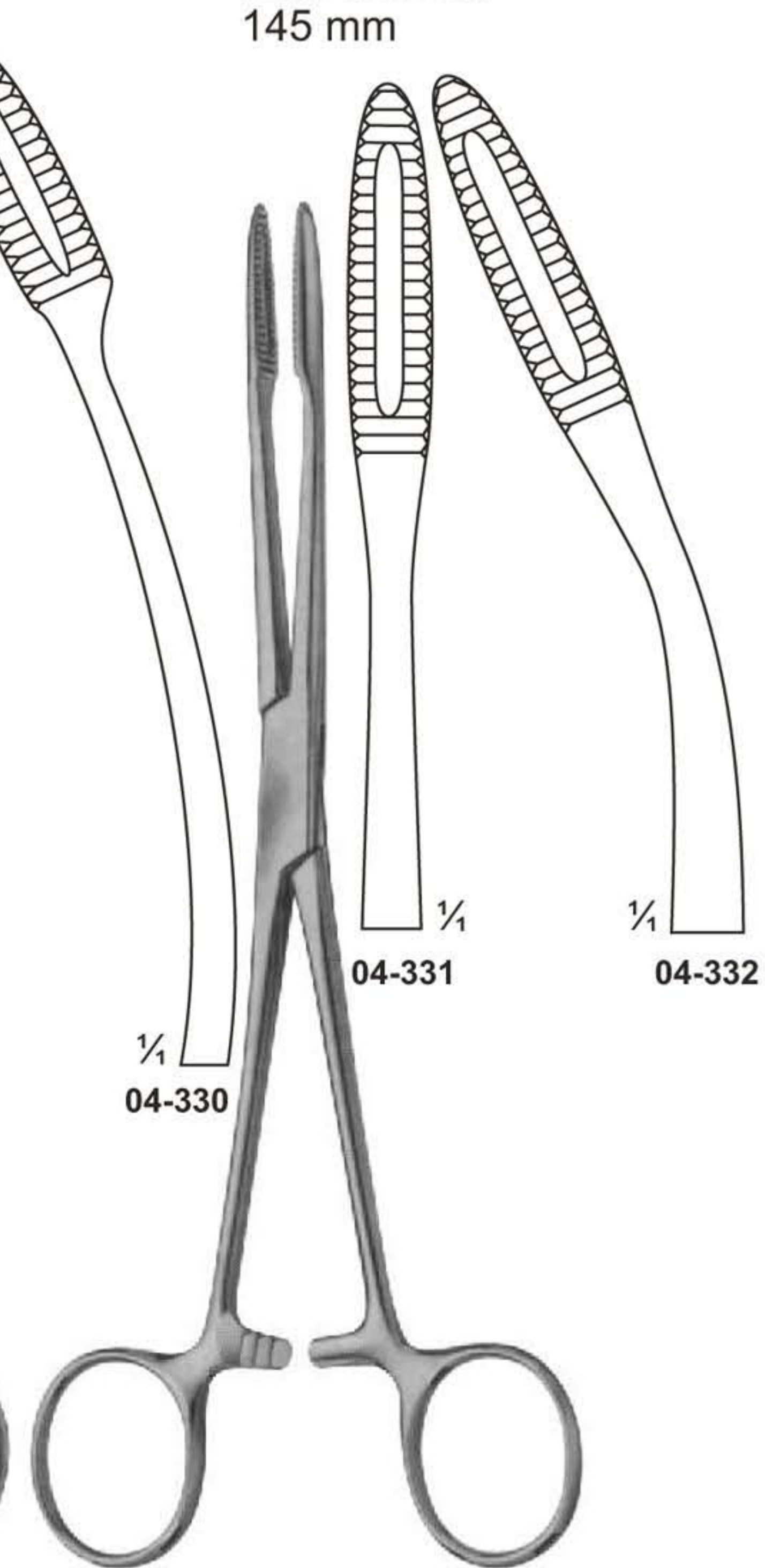

**04-331 - 332**  
GROSS  
With Ratchet  
200 mm



Sponge and Dressing Forceps

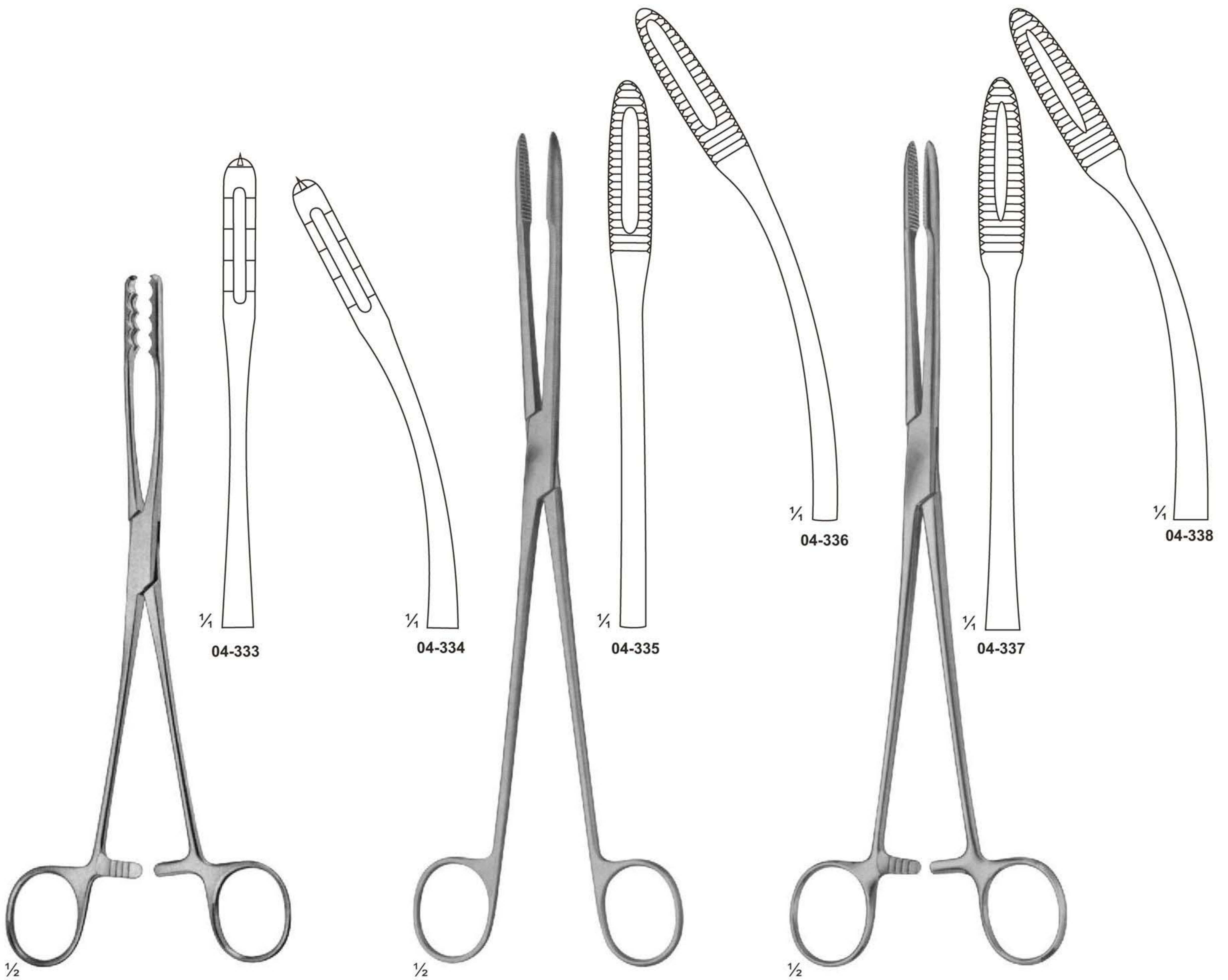

**04-333 - 334**  
AESCULAP  
220 mm

**04-335 - 336**  
MAIER  
Without Ratchet  
265 mm

**04-337 - 338**  
MAIER  
With Ratchet  
265 mm



# Sponge and Dressing Forceps

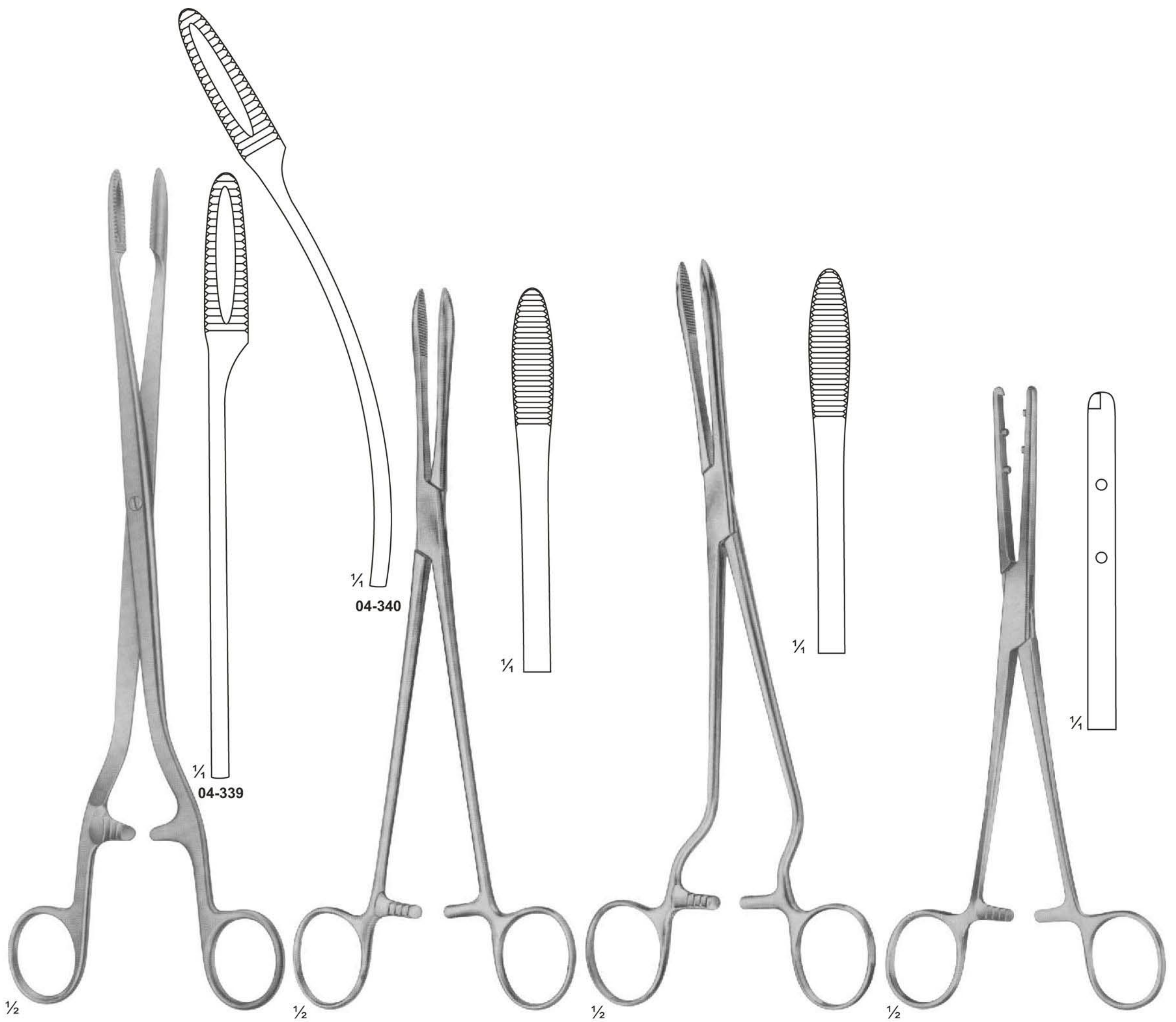

**04-339 - 340**  
SIMS-MAIER  
280 mm

**04-341**  
COLLIN  
240 mm

**04-342**  
CHERON  
Handles Laterally Angled  
240 mm

**04-343**  
EMMET  
210 mm



**Dressing, Sponge holding, Organ and Tissue Grasping Forceps**

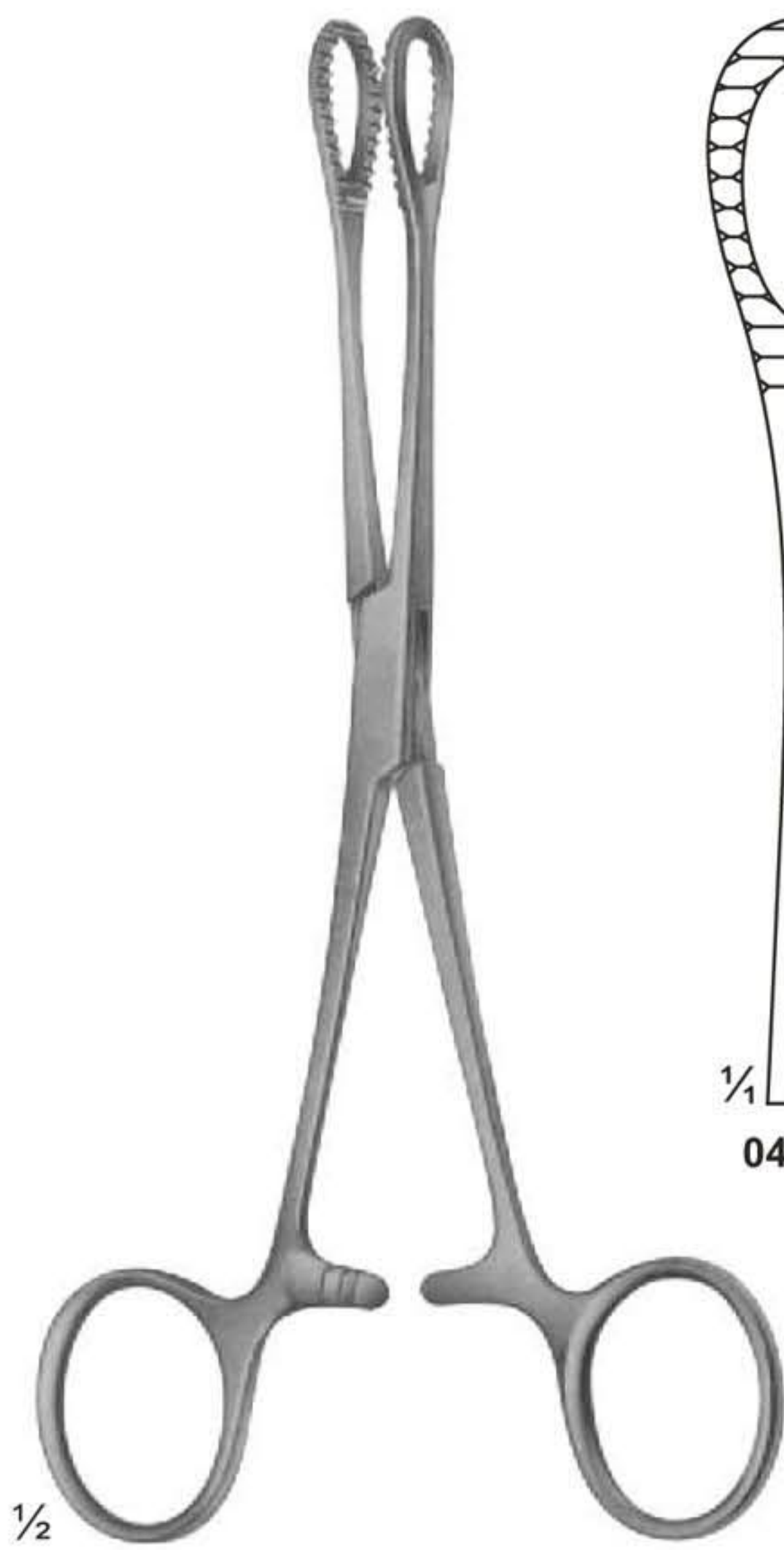

**04-344 - 345**  
FOERSTER-BALLENGER  
180 mm

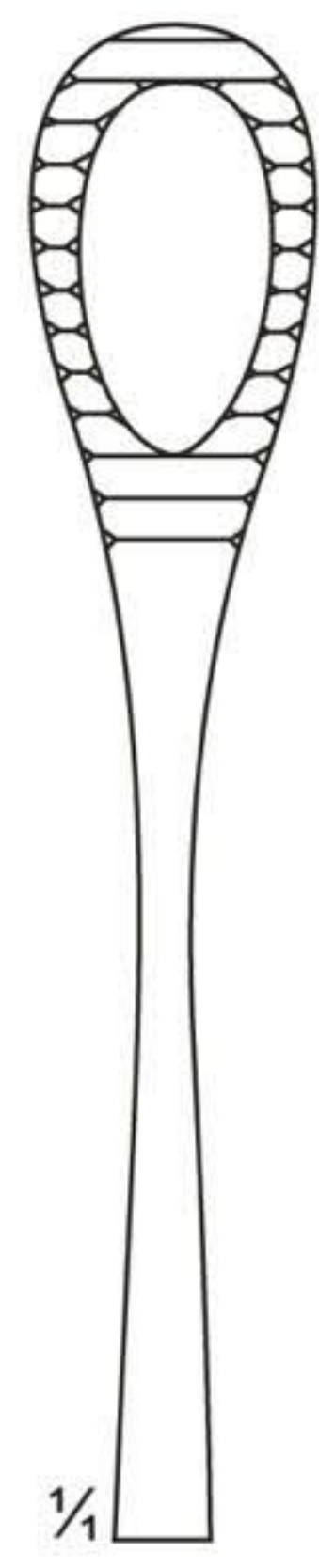

**04-344**



**04-345**



**04-346 - 347**  
RAMPLEY



**04-346**  
180 mm

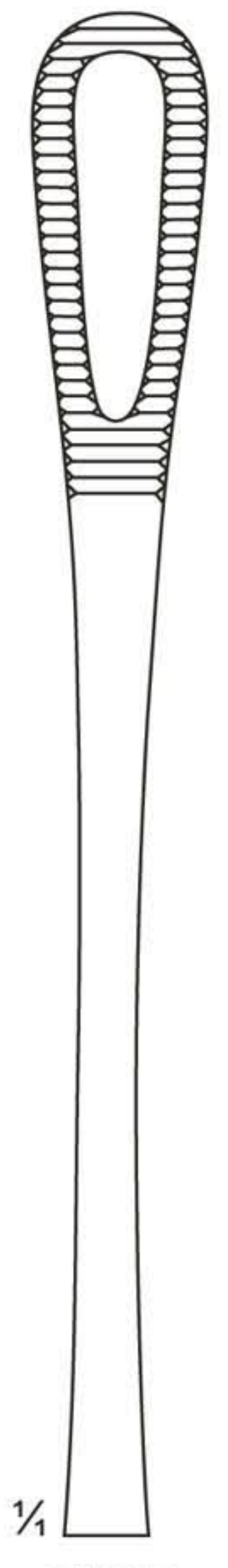

**04-347**  
250 mm

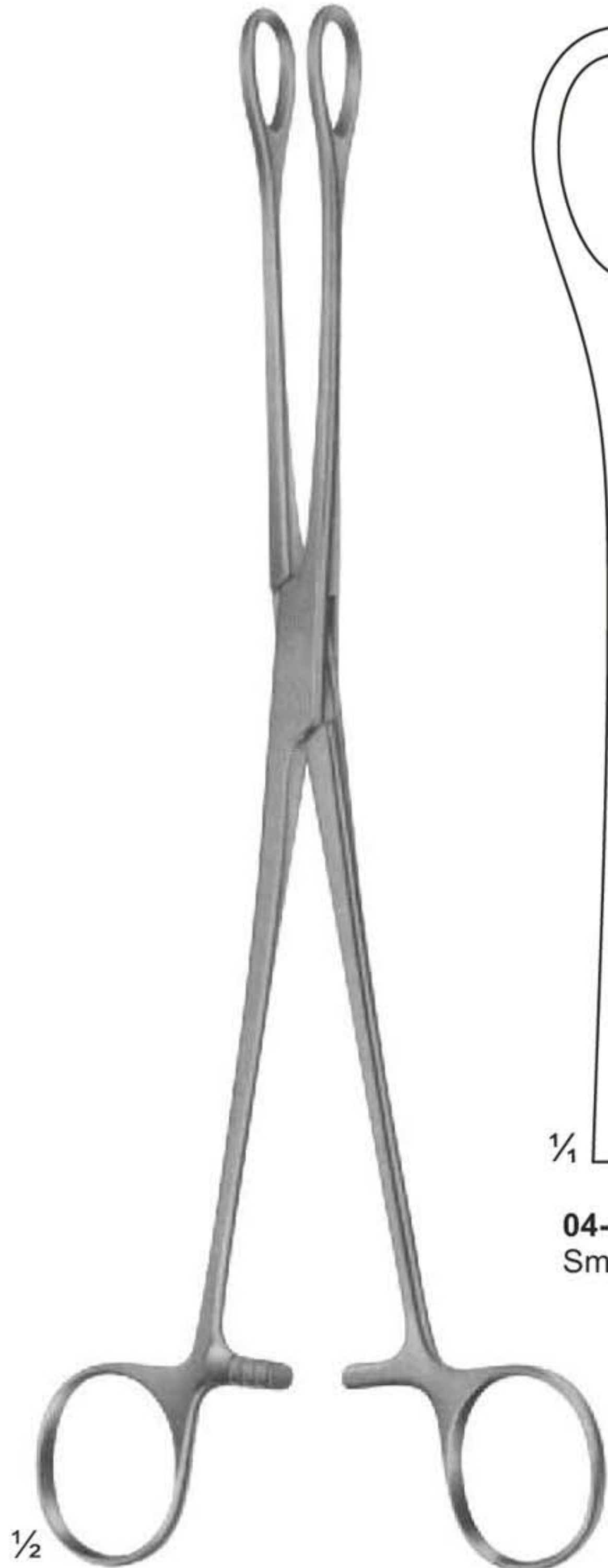

**04-348 - 351**  
FOERSTER-BALLENGER  
240 mm

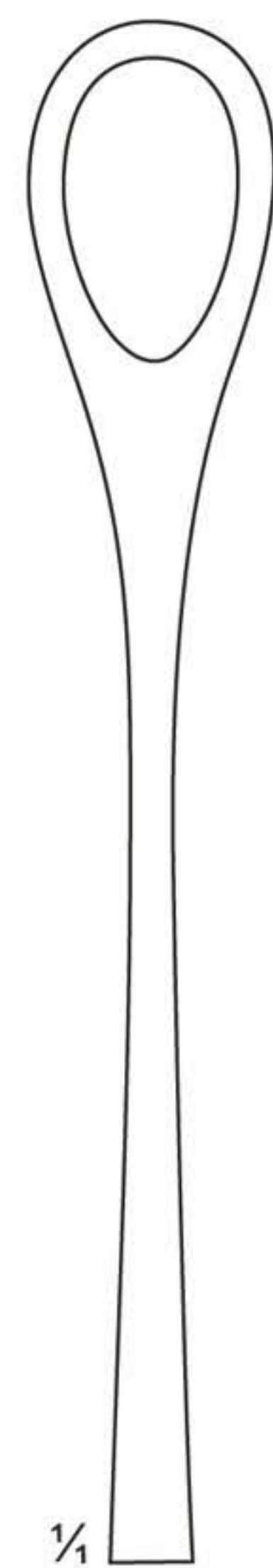

**04-348**  
Smooth Jaws

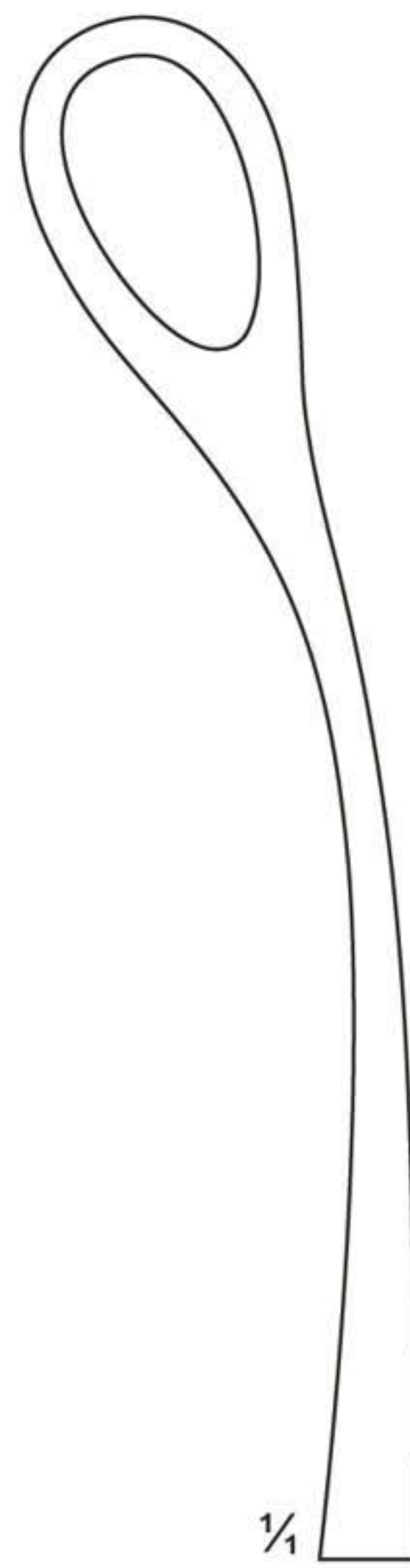

**04-349**  
Smooth Jaws

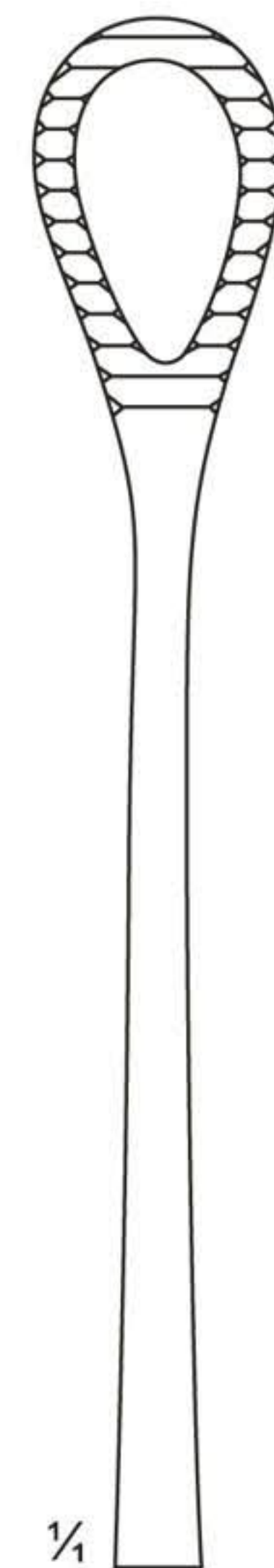

**04-350**  
Serrated Jaws

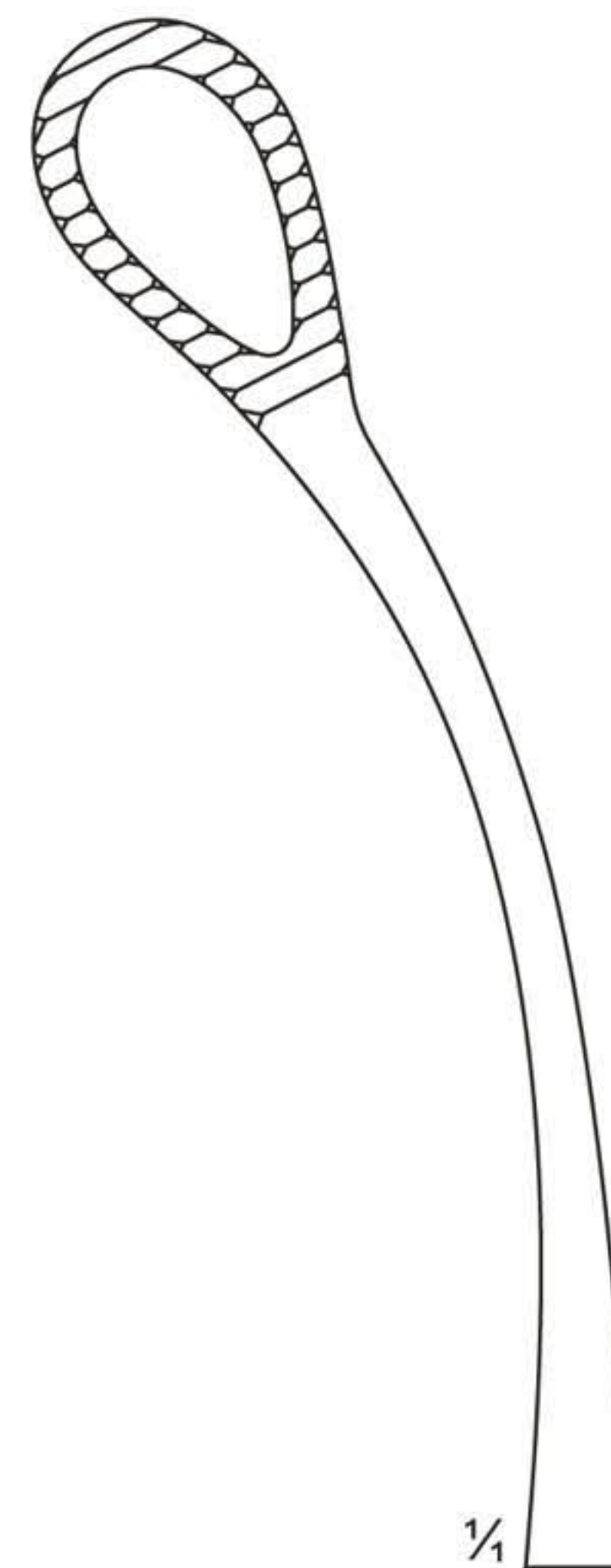

**04-351**  
Serrated Jaws

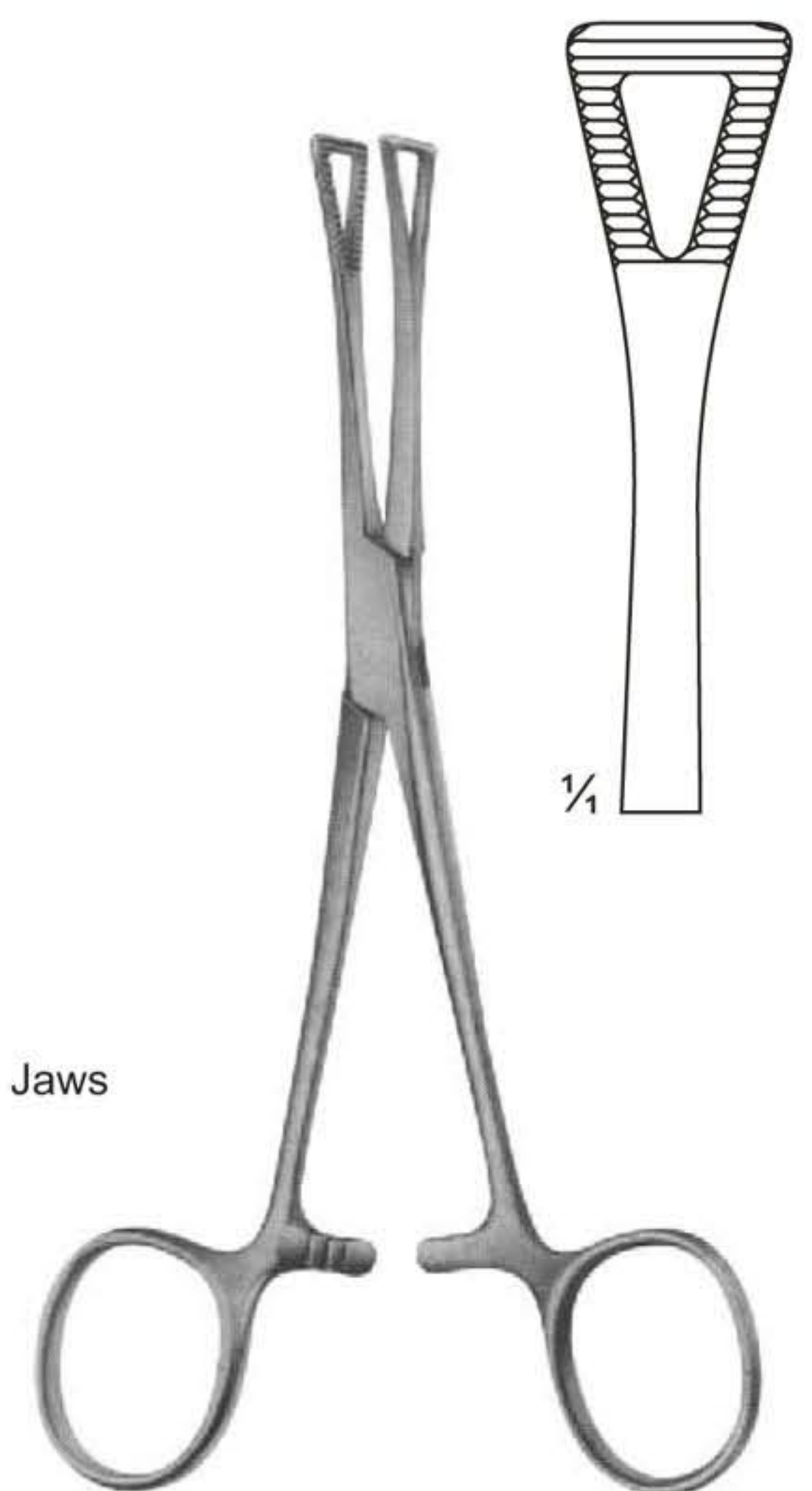

**04-352**  
PENNINGTON  
155 mm



**Dressing, Sponge holding, Organ and Tissue Grasping Forceps**

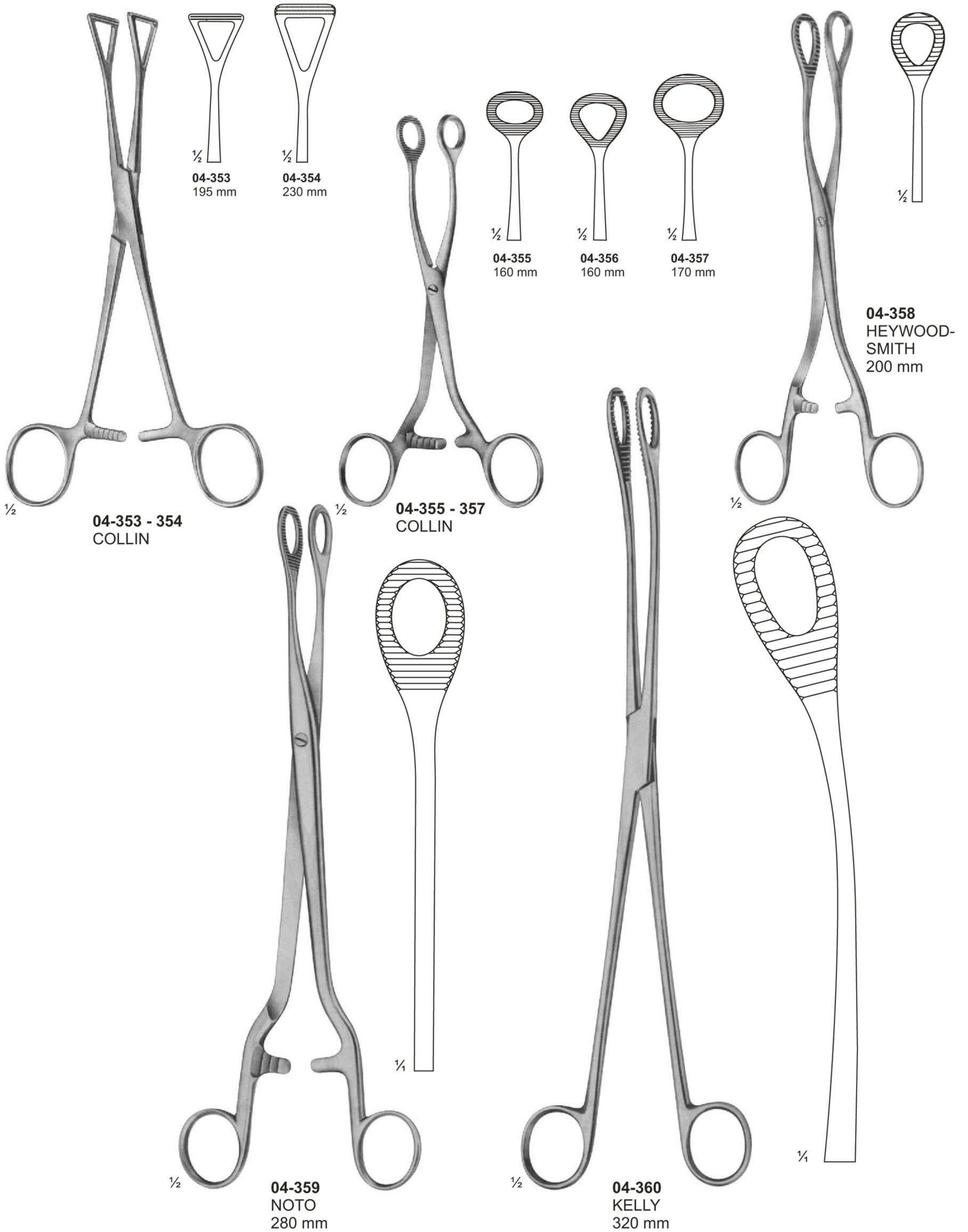



**Tendon Seizing Forceps**

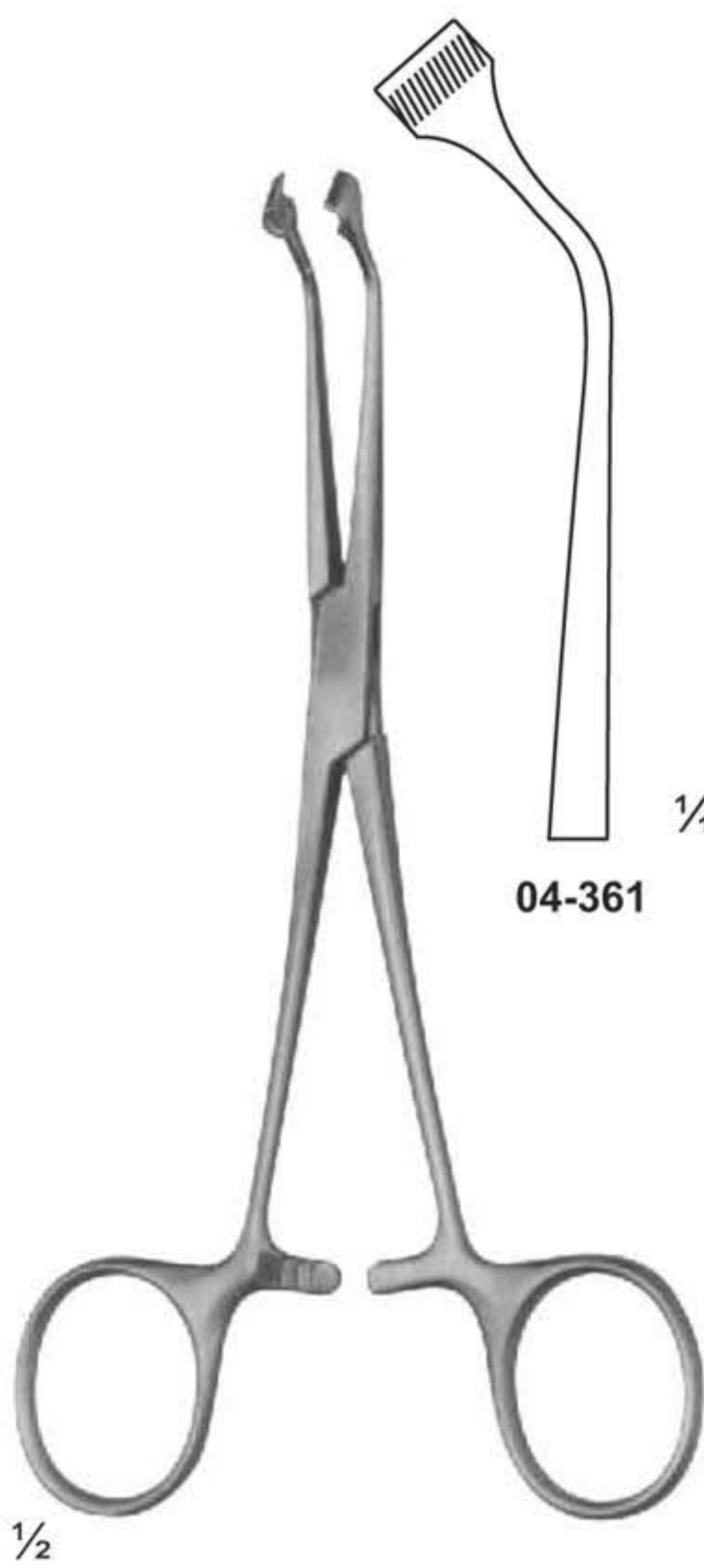

**04-361 - 362**  
HERZ  
155 mm

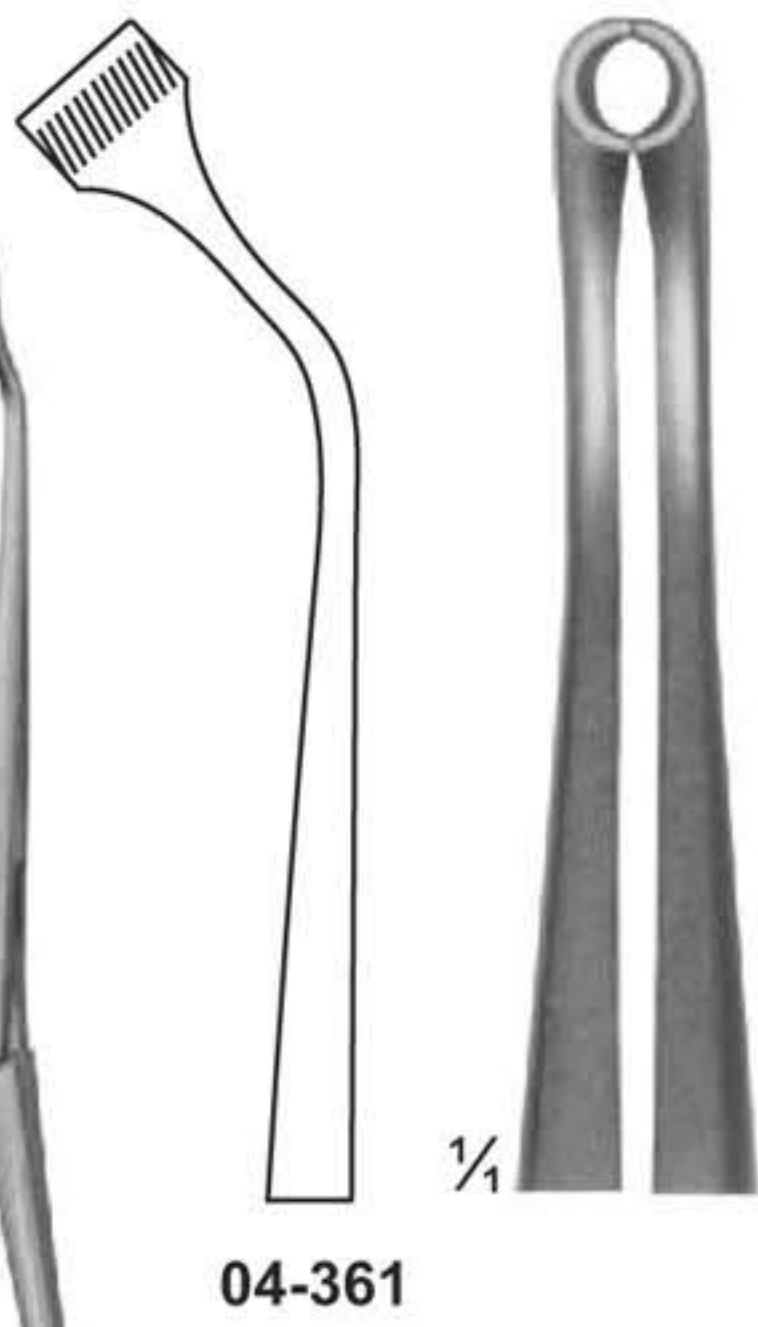

04-361

1/4

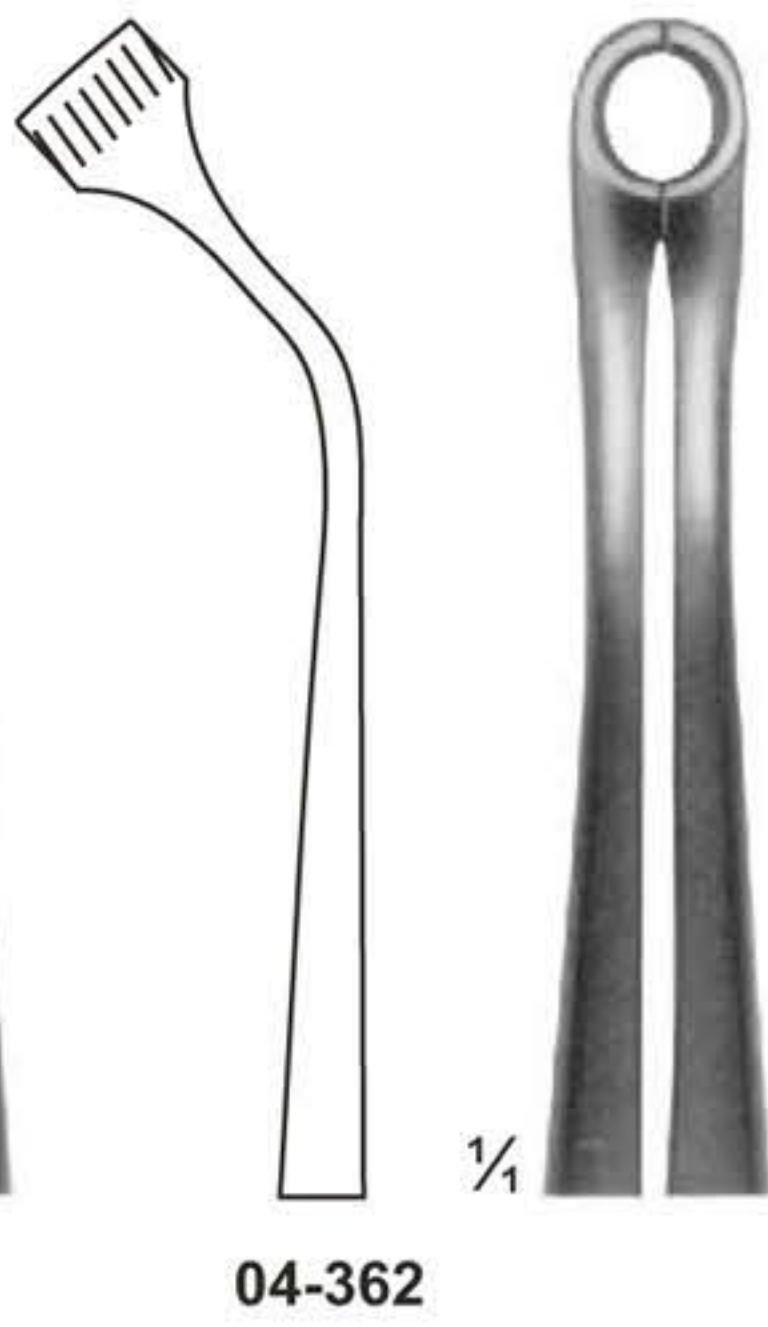

04-362

1/4



**04-363**  
JACKSON  
4 x 5 teeth  
150 mm



04-363



1/4

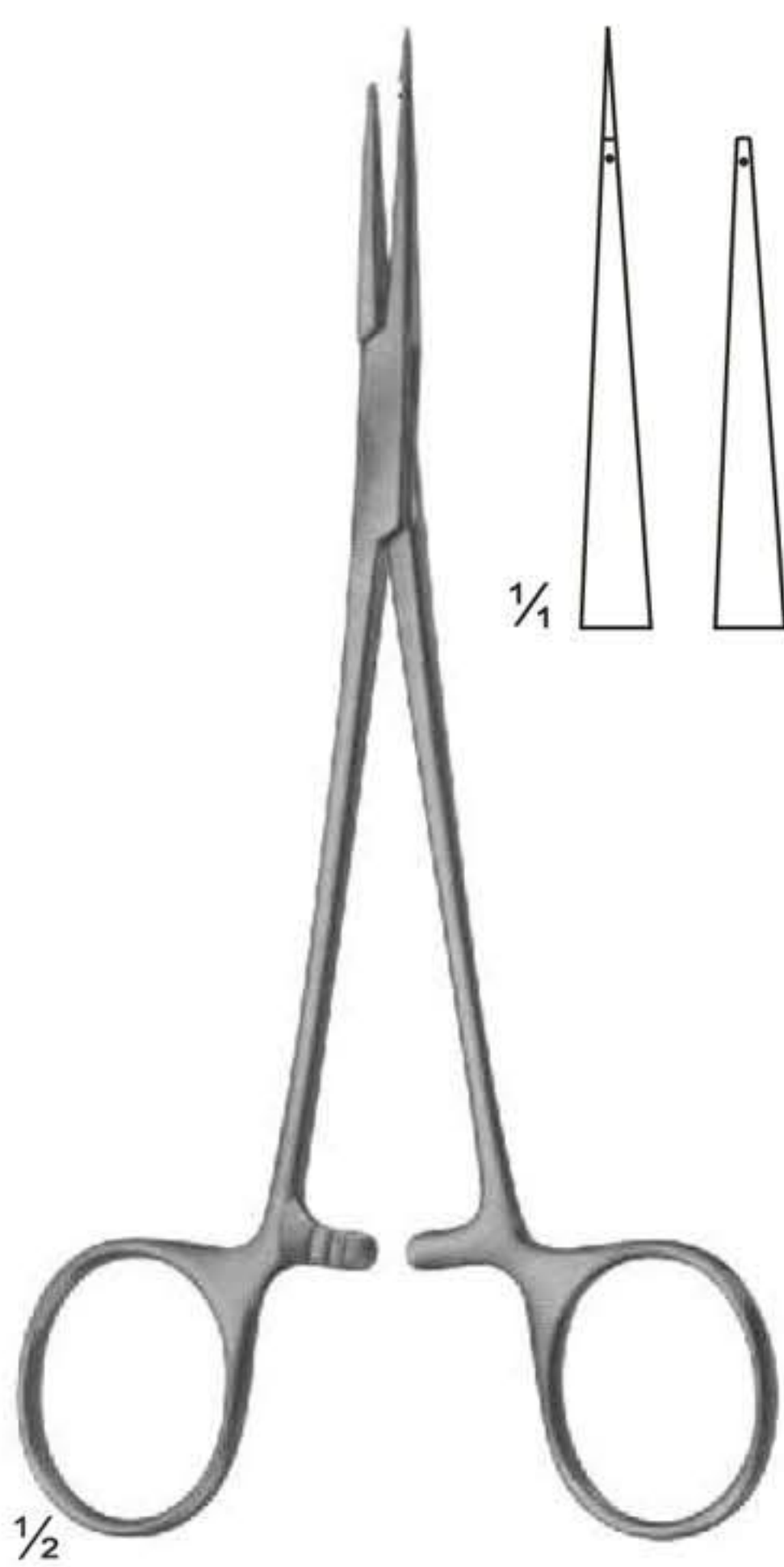

**04-364**  
150 mm

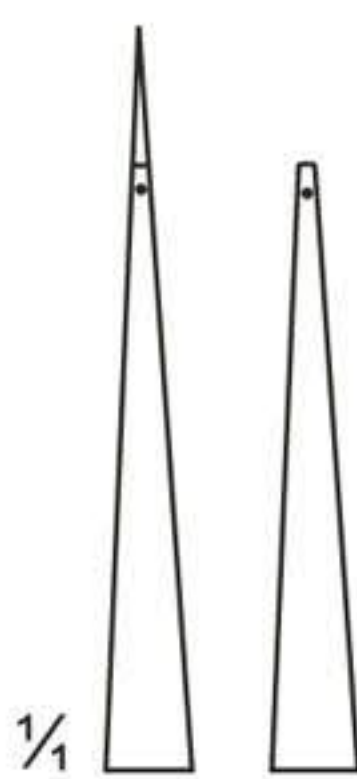

1/4

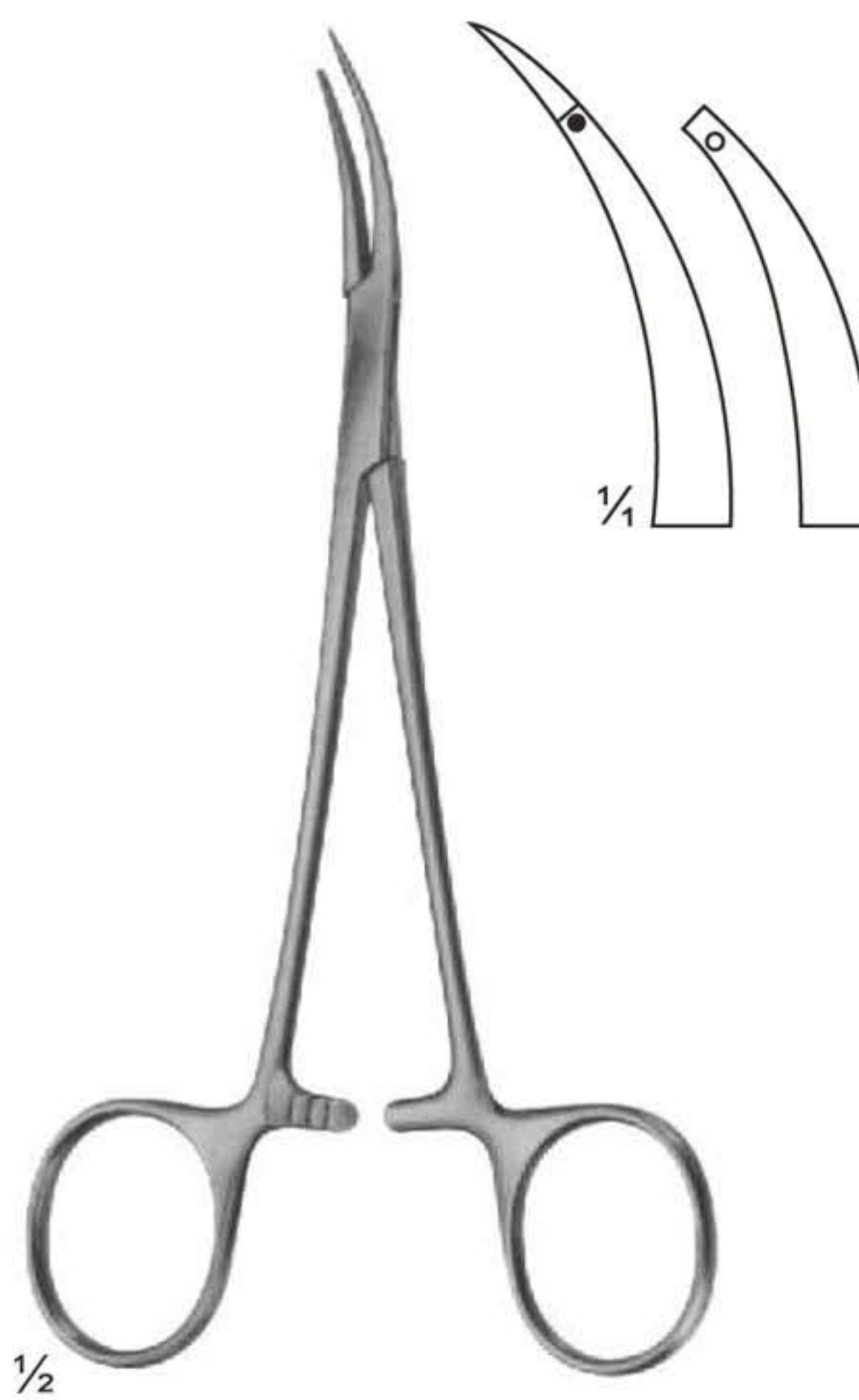

**04-365**  
150 mm

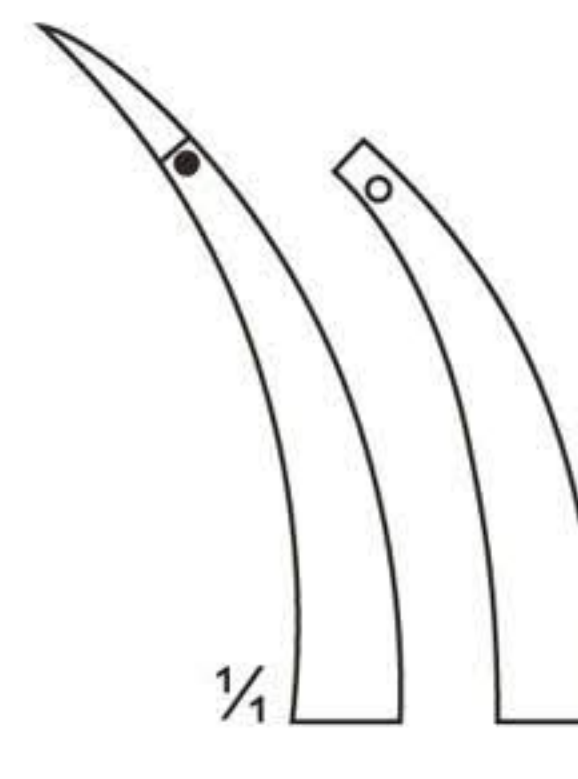

1/4



**04-366**  
120 mm

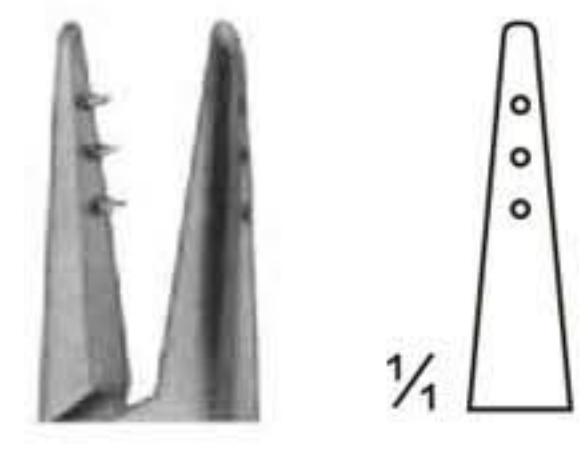

1/4



1/4

**04-367**  
JAGER  
Tendon-and cross ligament  
passing forceps  
flexible shaft  
275 mm



1/2



## Artery Traction - and Tissue Grasping Forceps

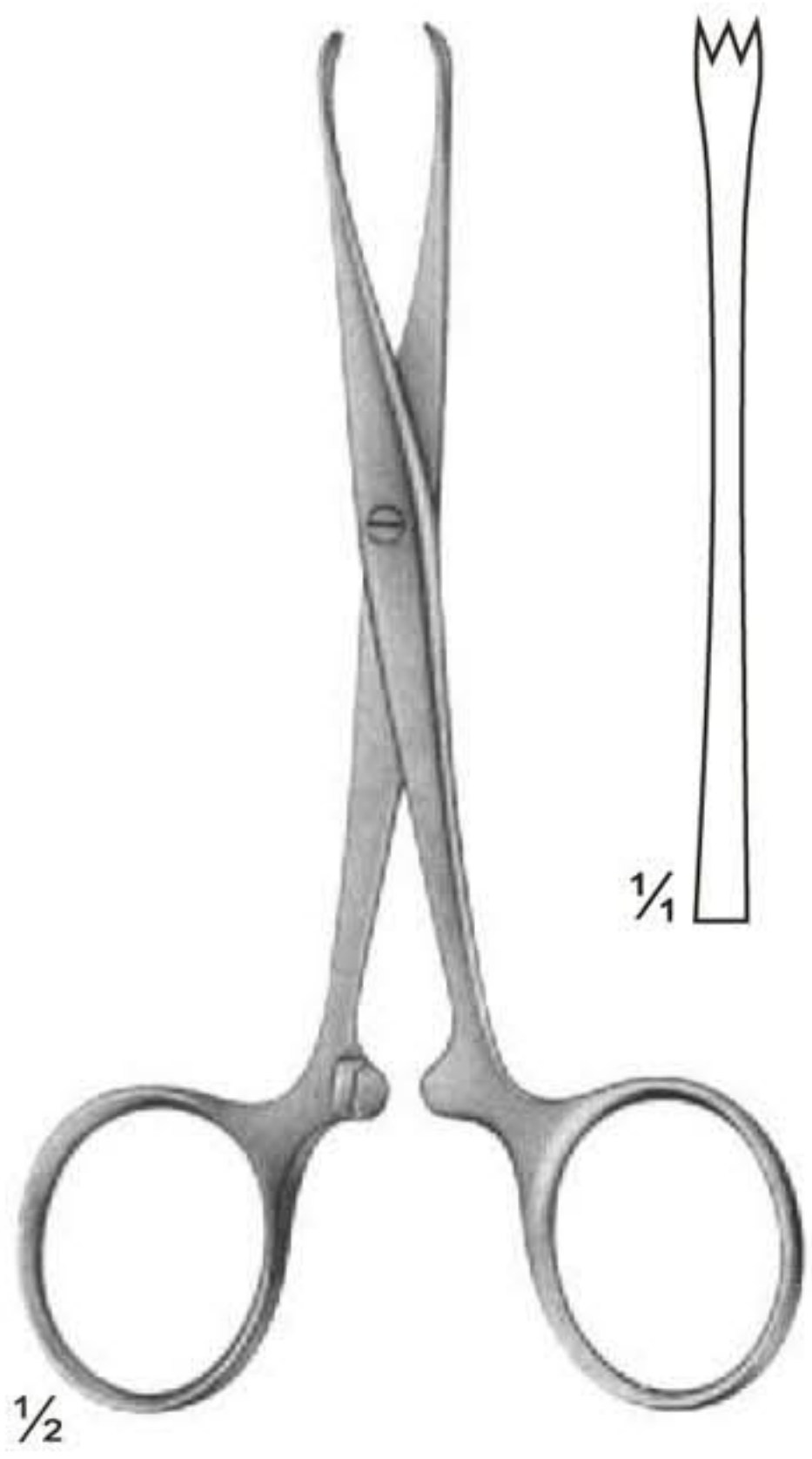

1/2

**04-368**  
CHAPUT  
2 x 3 teeth  
125 mm

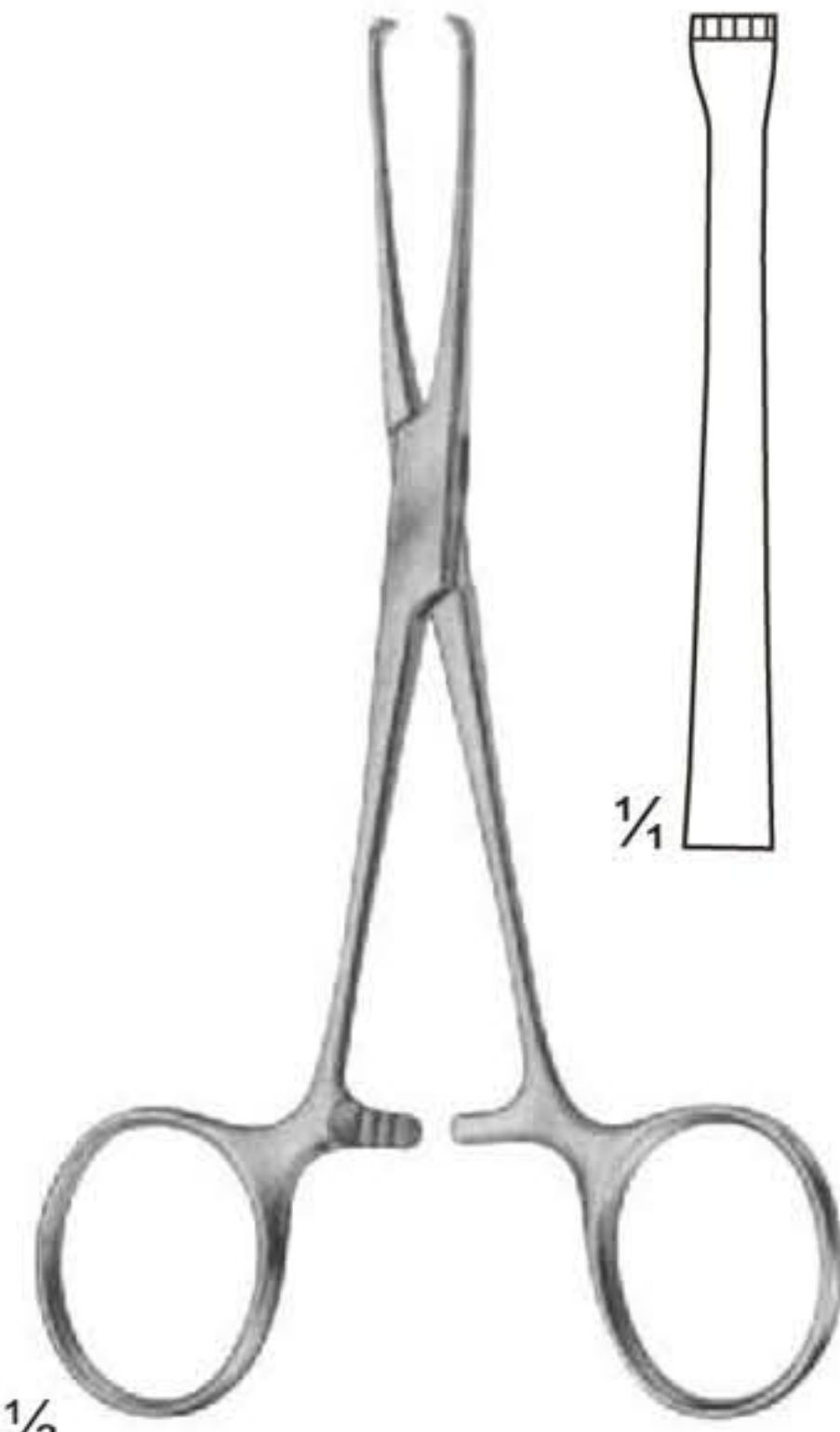

1/2

**04-369**  
BABY-ALLIS  
4 x 5 teeth  
130 mm

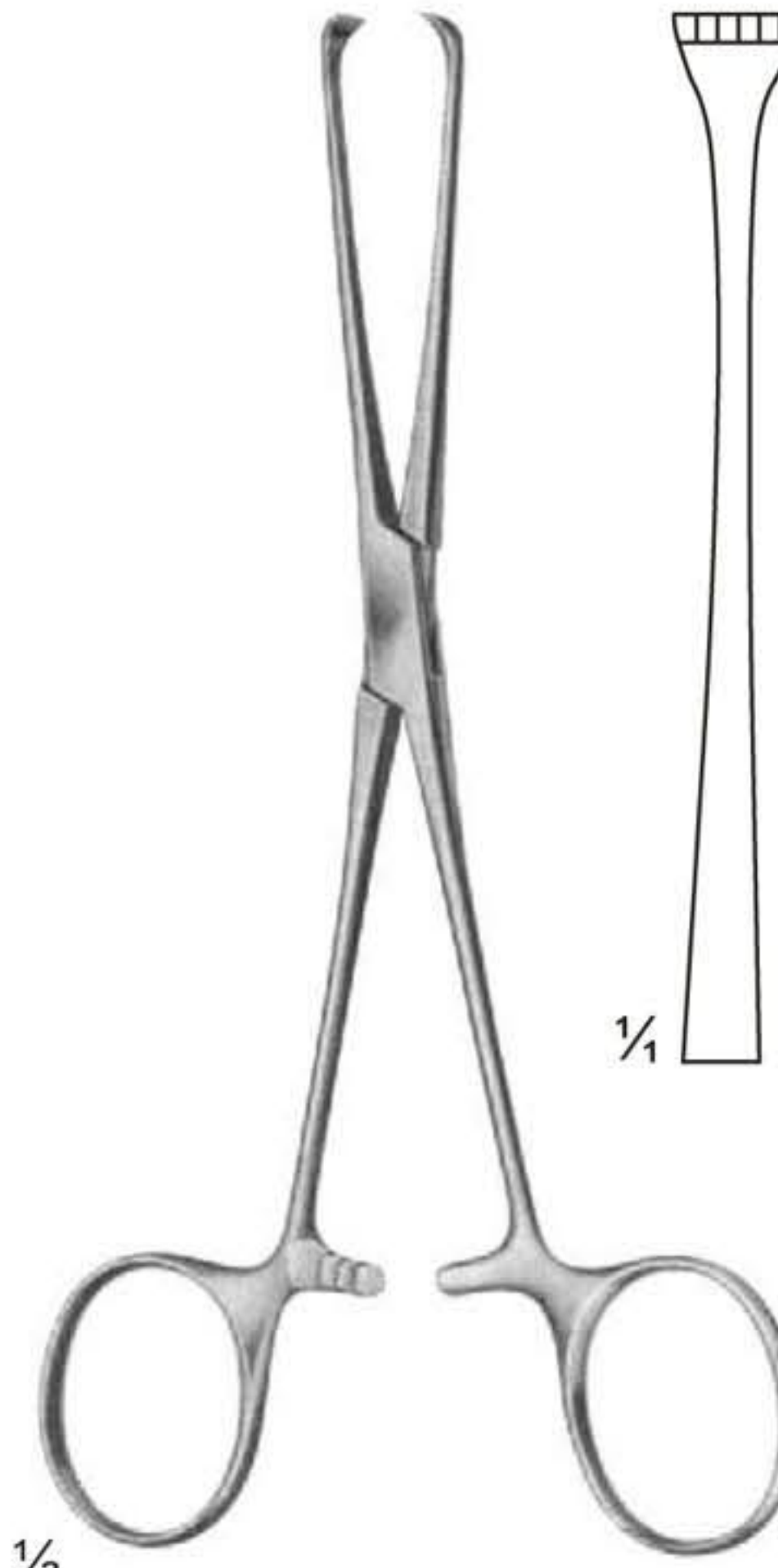

1/2

**04-370**  
BOYS-ALLIS  
5 x 6 teeth  
155 mm

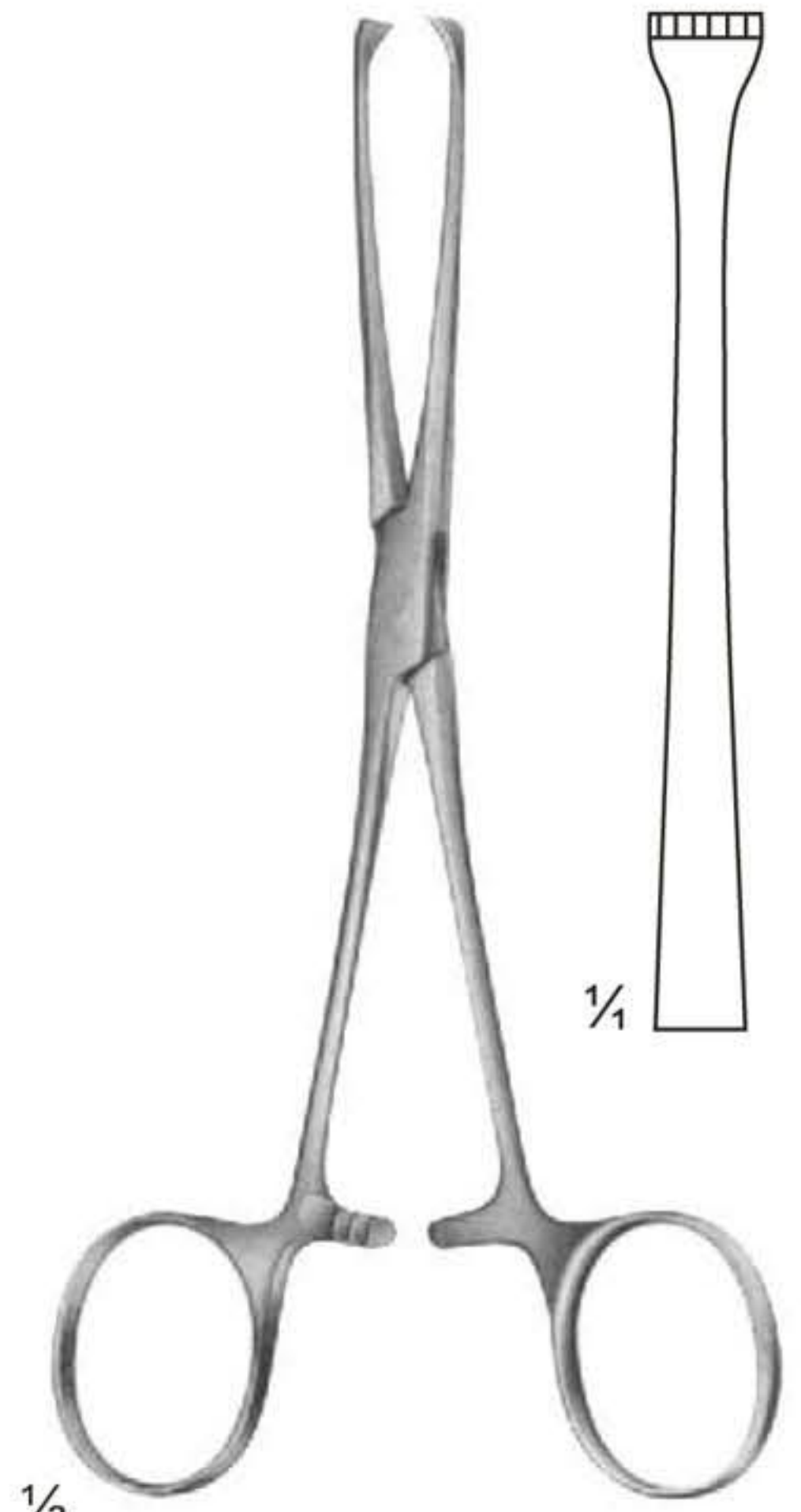

1/2

**04-371**  
ALLIS  
5 x 6 teeth  
155 mm

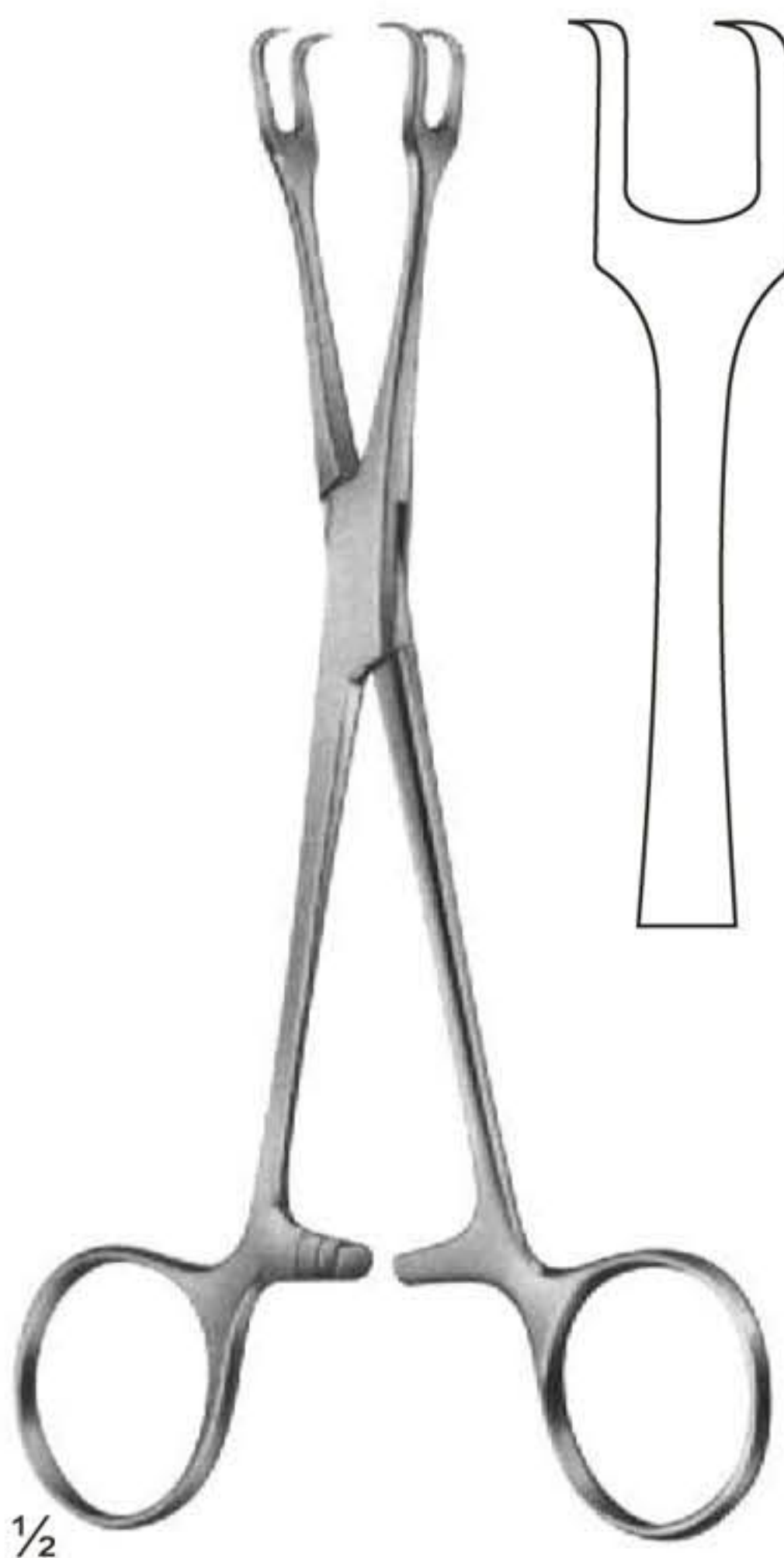

1/2

**04-372**  
LAHEY  
135 mm

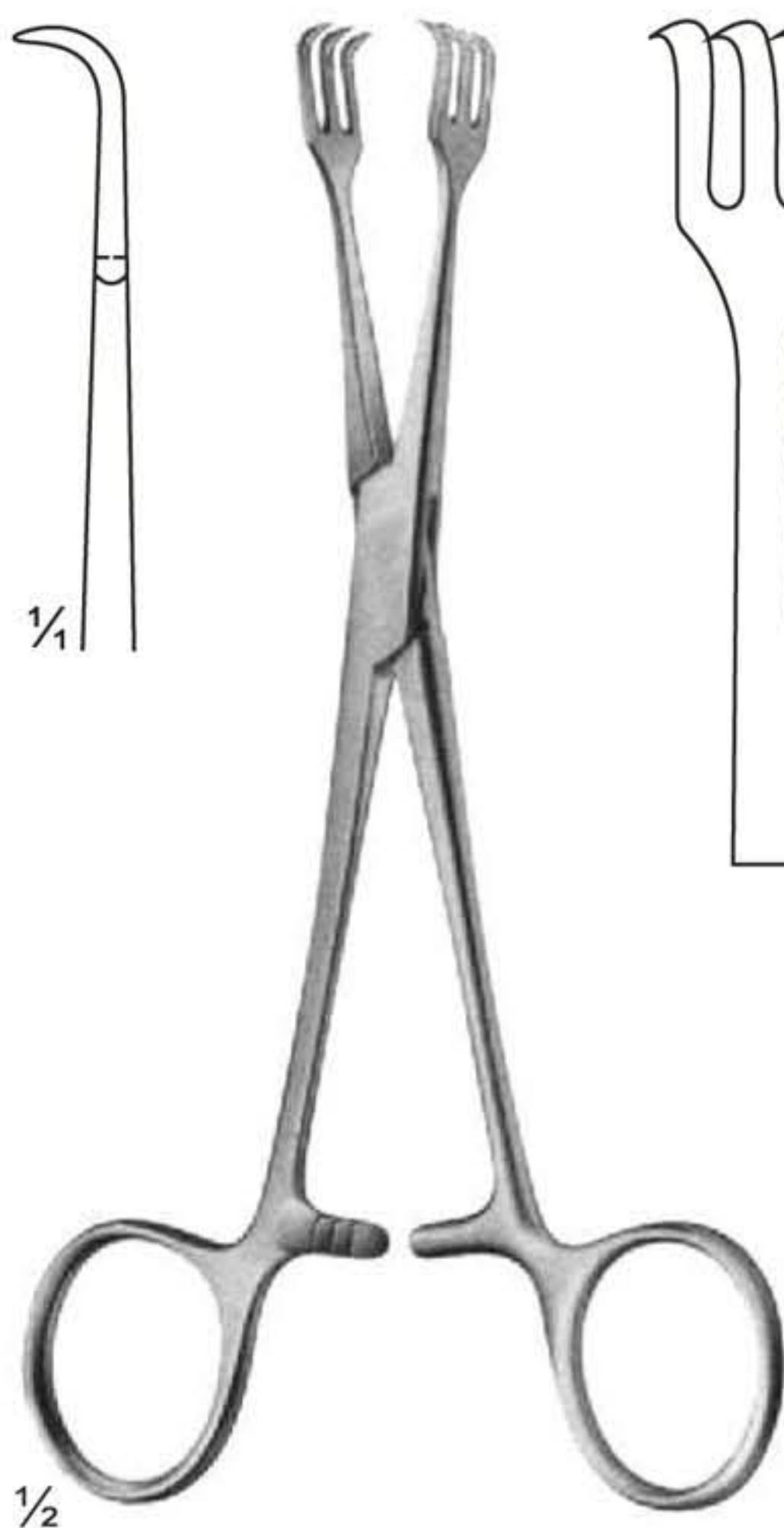

1/2

**04-373**  
LAHEY  
135 mm

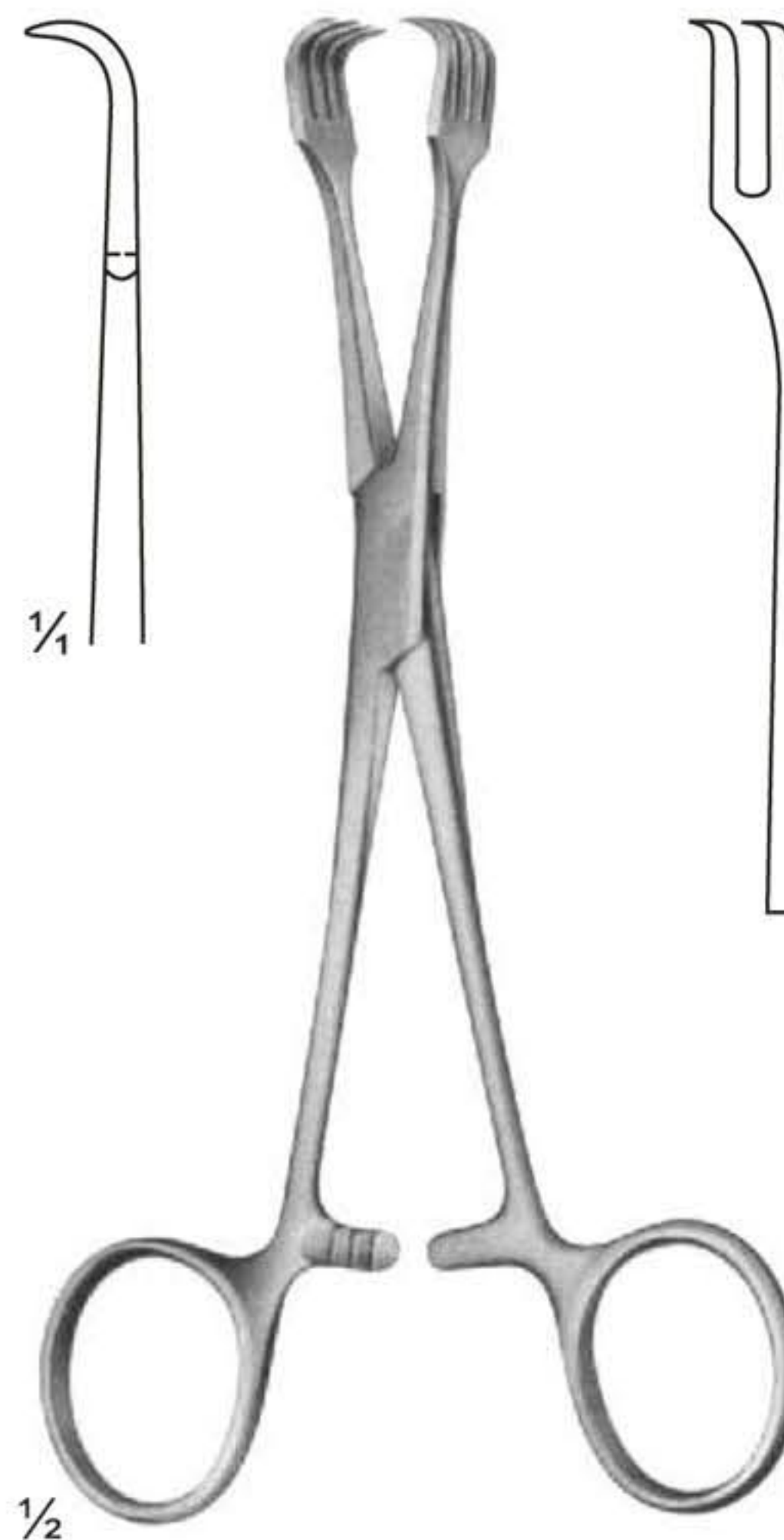

1/2

**04-374**  
BRAUN  
155 mm

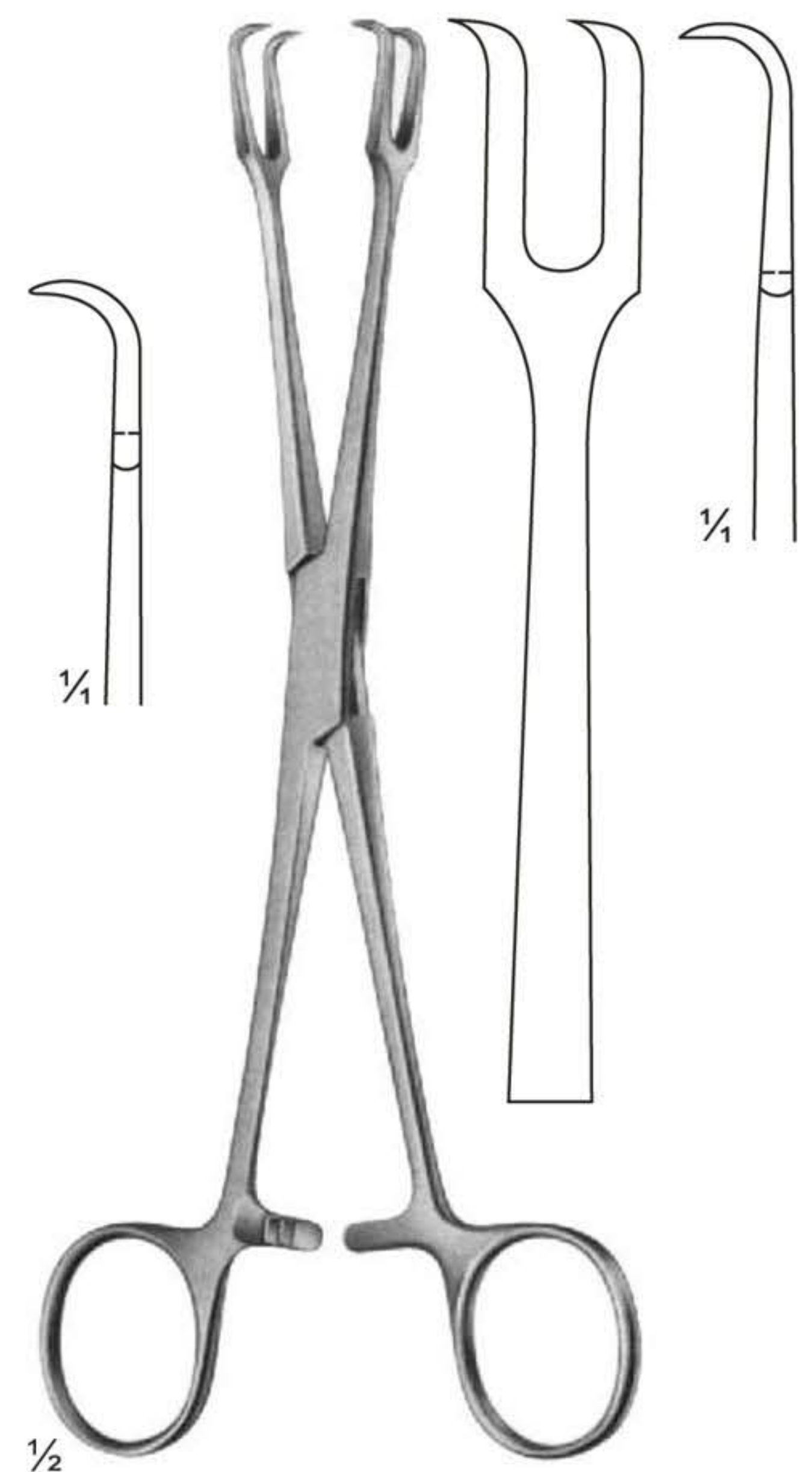

1/2

**04-375**  
MUSEUX  
200 mm



**Organ - and Tissue Grasping Forceps**

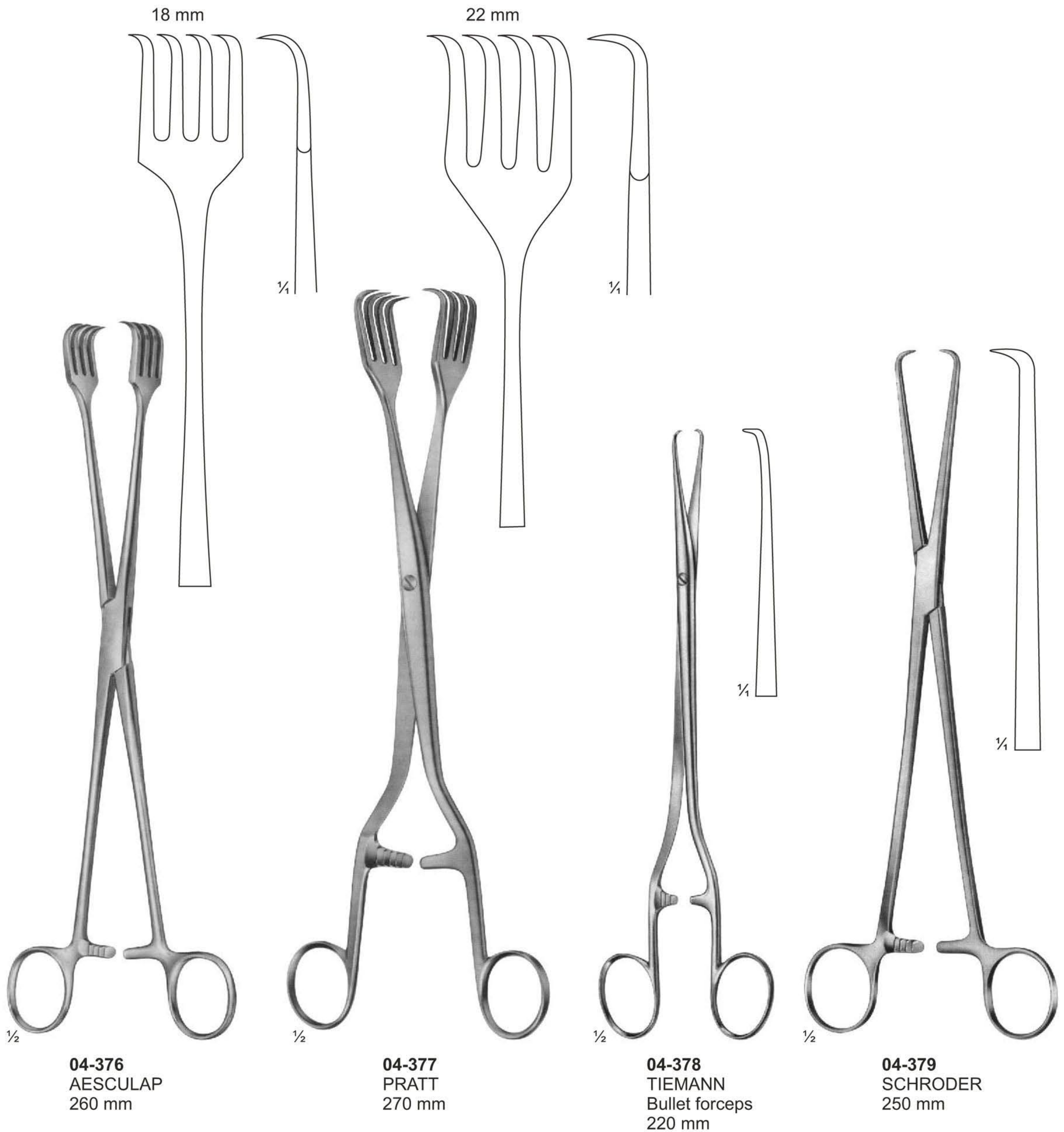



**Towel Clamps**

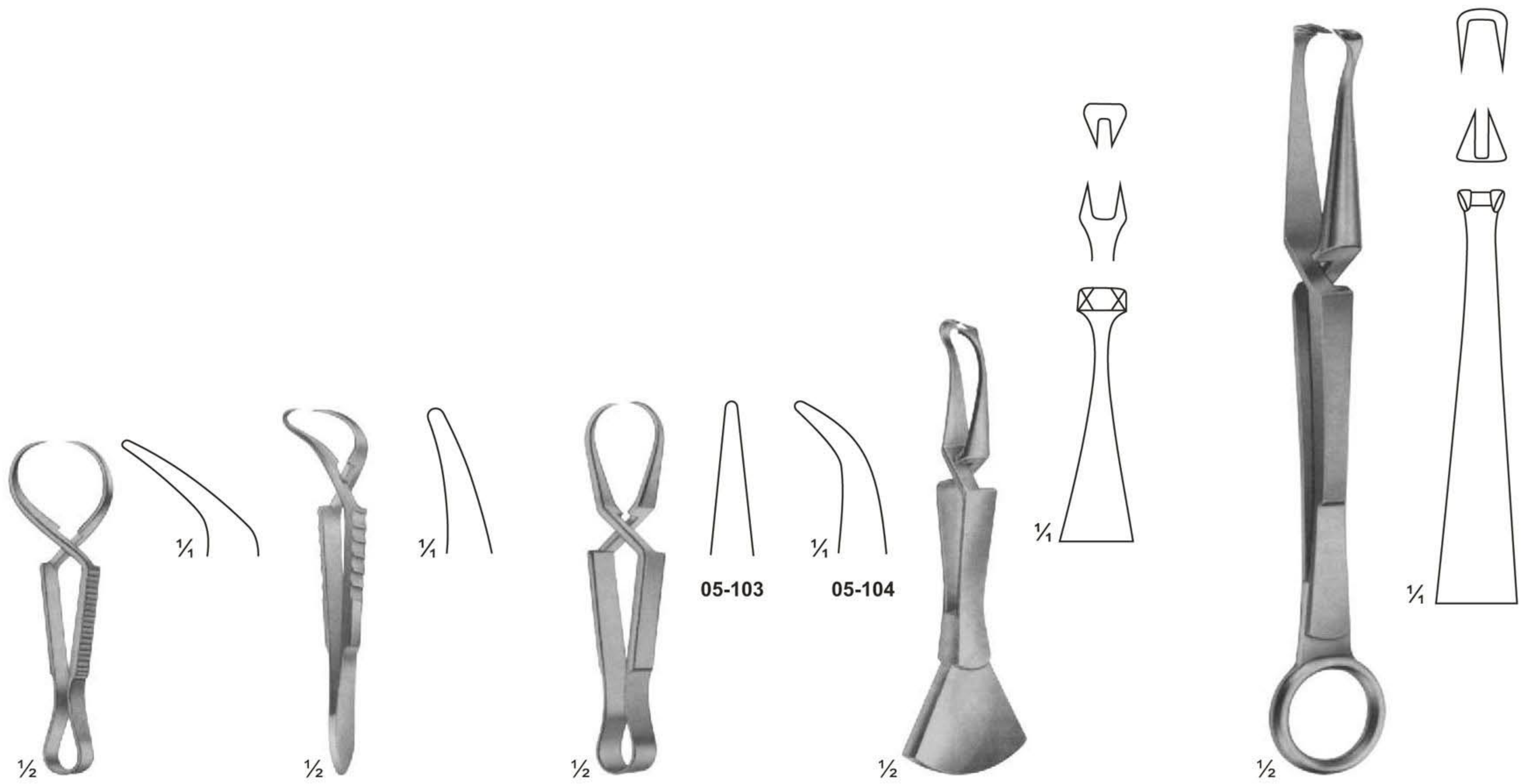

**05-101**  
JONES  
85 mm

**05-102**  
ENGL. MOD.  
85 mm

**05-103 - 104**  
SCHAEDEL  
85 mm

**05-105**  
DOYEN  
110 mm

**05-106**  
DOYEN  
180 mm

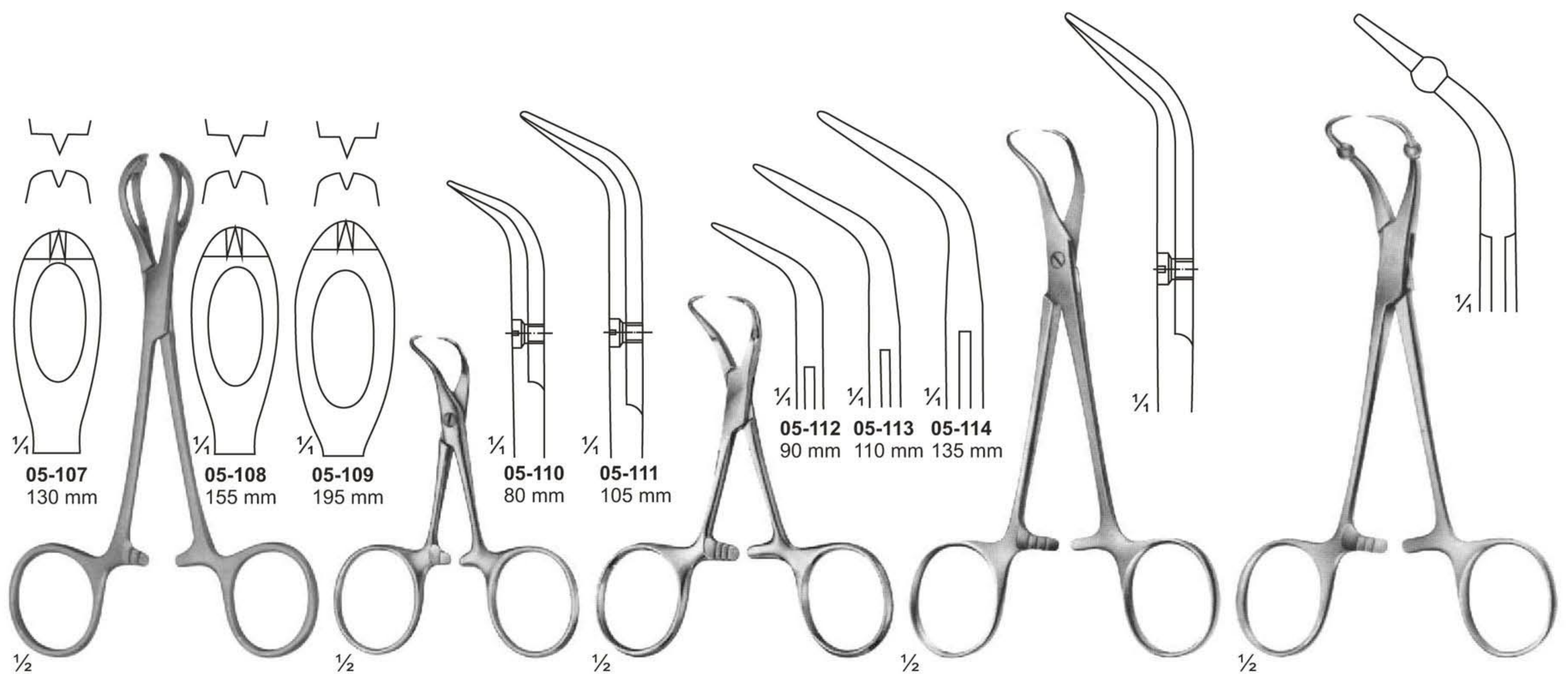

**05-107**  
130 mm

**05-108**  
155 mm

**05-109**  
195 mm

**05-110**  
80 mm

**05-111**  
105 mm

**05-112 05-113 05-114**  
90 mm 110 mm 135 mm

**05-107 - 109**  
LANE

**05-110 - 111**  
BACKHAUS

**05-112 - 114**  
BACKHAUS

**05-115**  
BACKHAUS-KOCHER  
135 mm

**05-116**  
ROEDER  
135 mm



## Towel Clamps

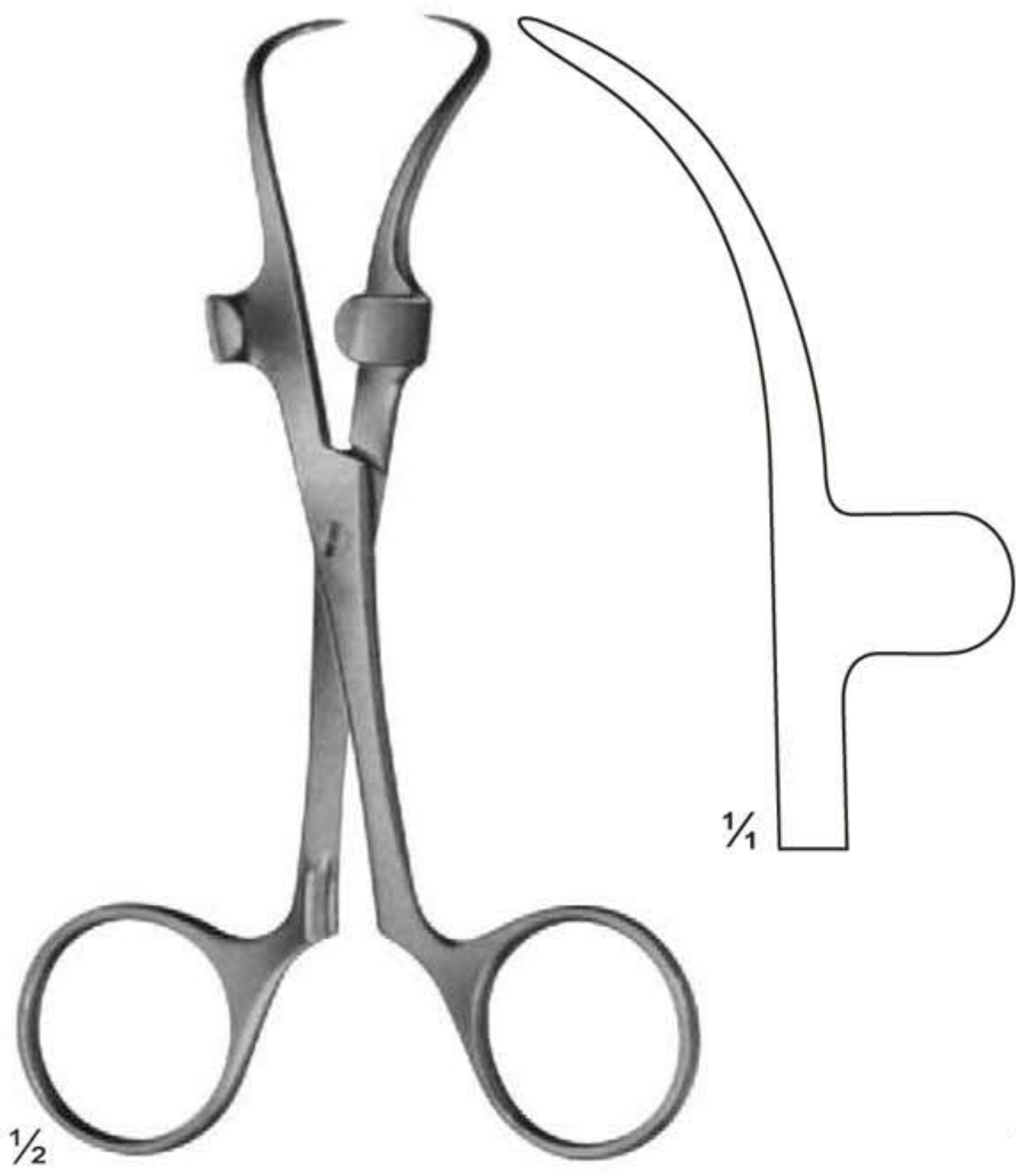

**05-117**  
**ROBIN**  
with holders for tubing  
up to 13 mm  
135 mm

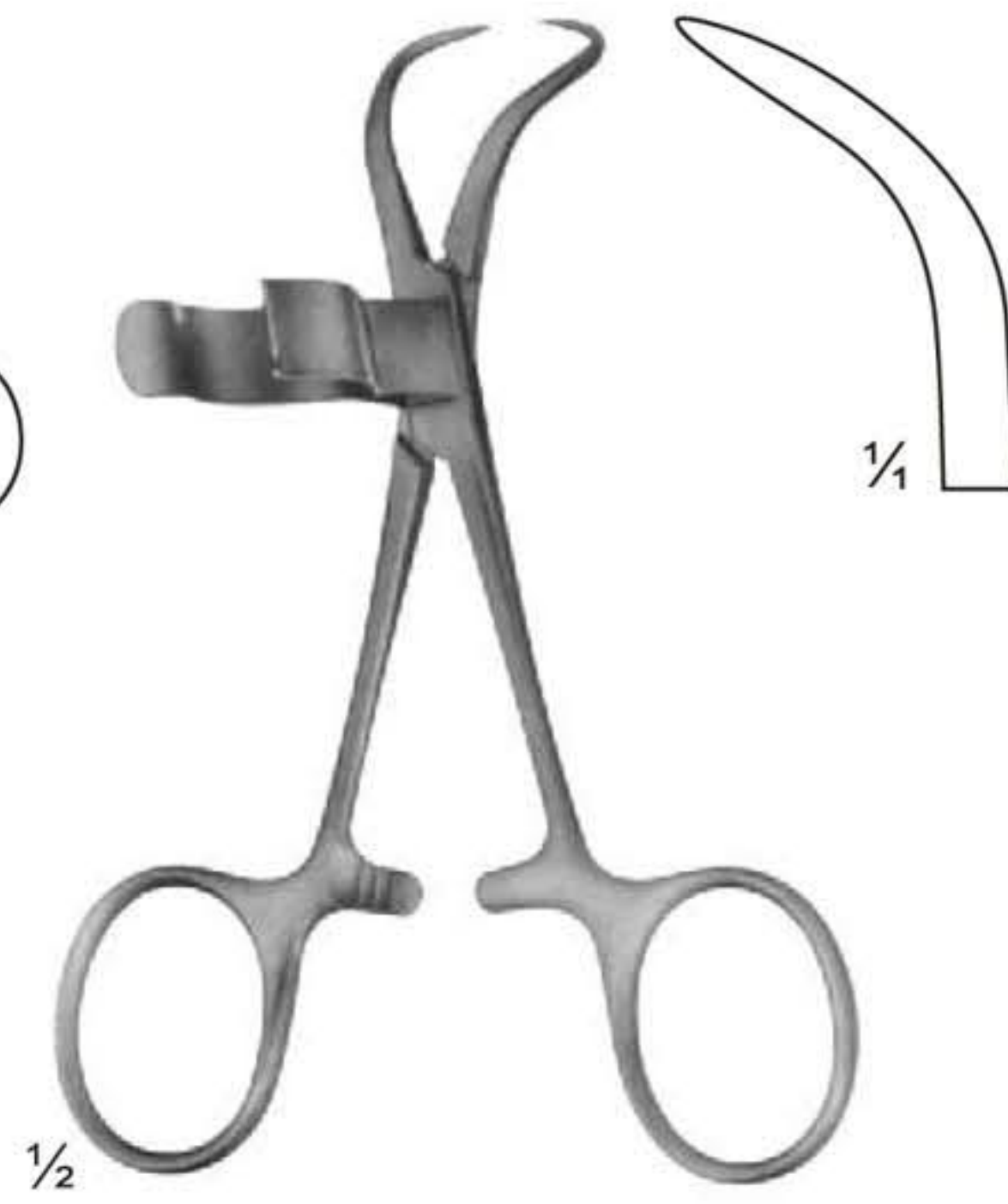

**05-118**  
with clip for tubing  
up to 15 mm  
110 mm

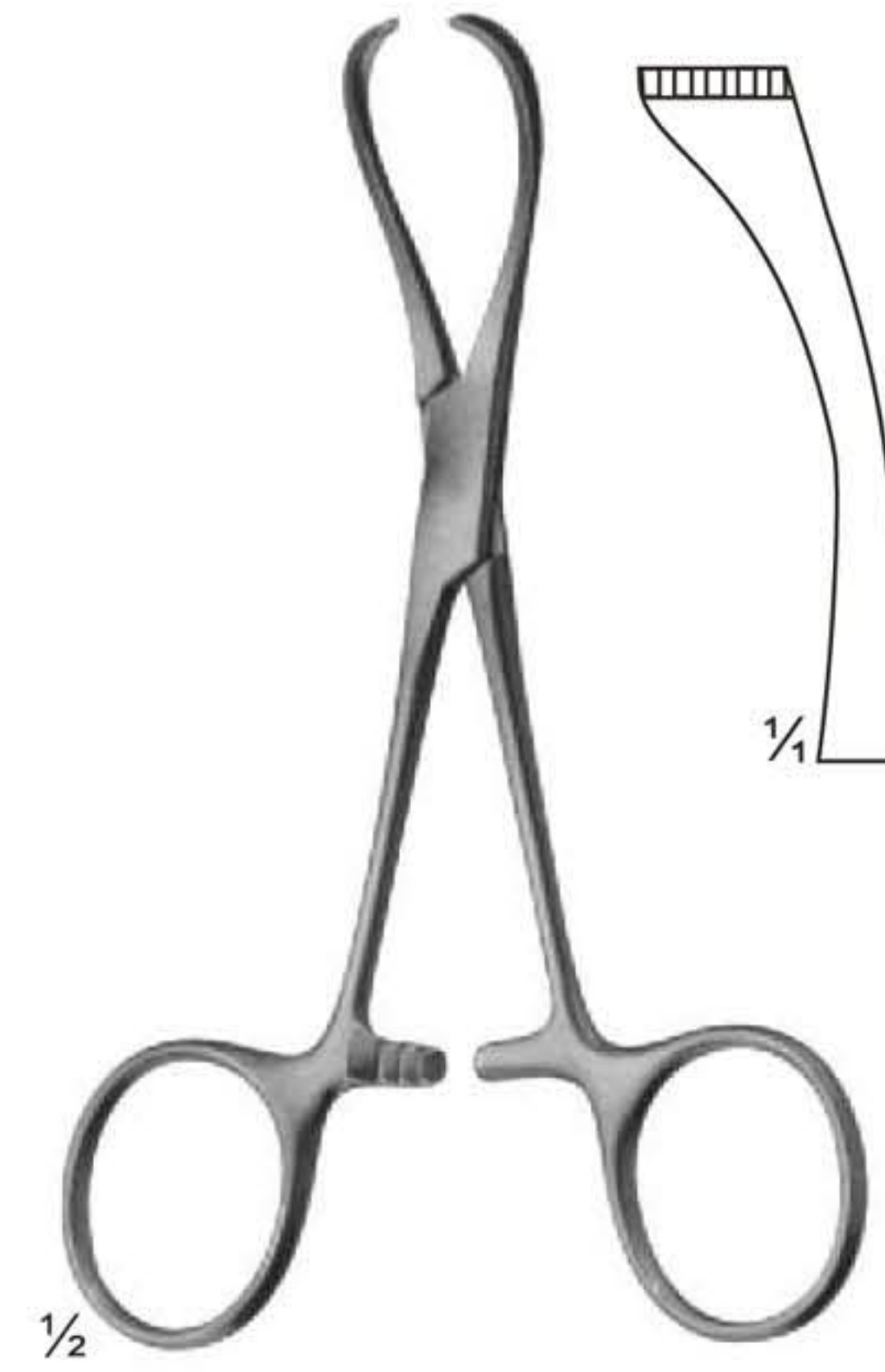

**05-119**  
**LORNA**  
non perforating  
130 mm

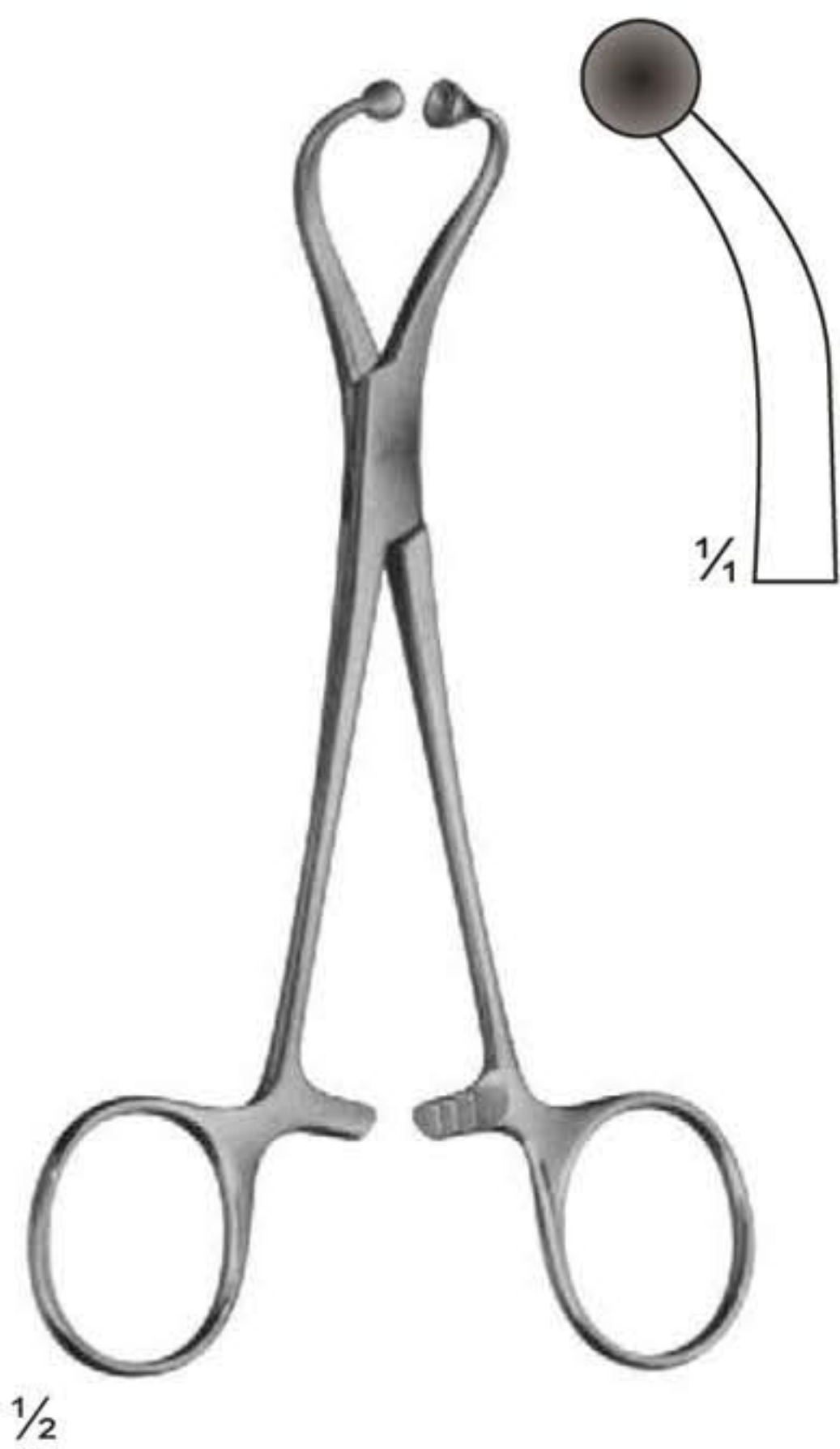

**05-120**  
for paper cloths  
140 mm



**05-121**  
**BUNT**  
105 mm



**05-122**  
**MAYO**  
140 mm



# Muller Vessel Clips and Bulldog Clamps

## Closing force

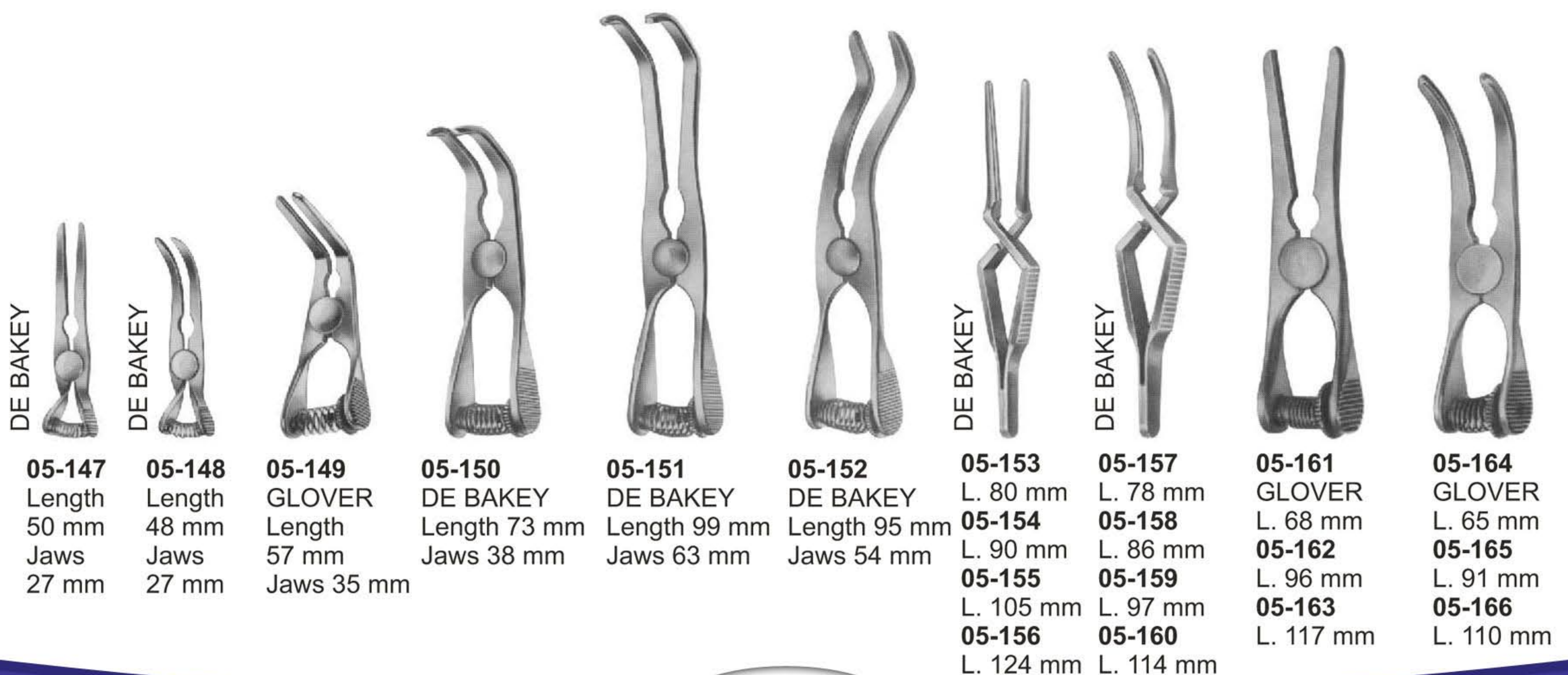
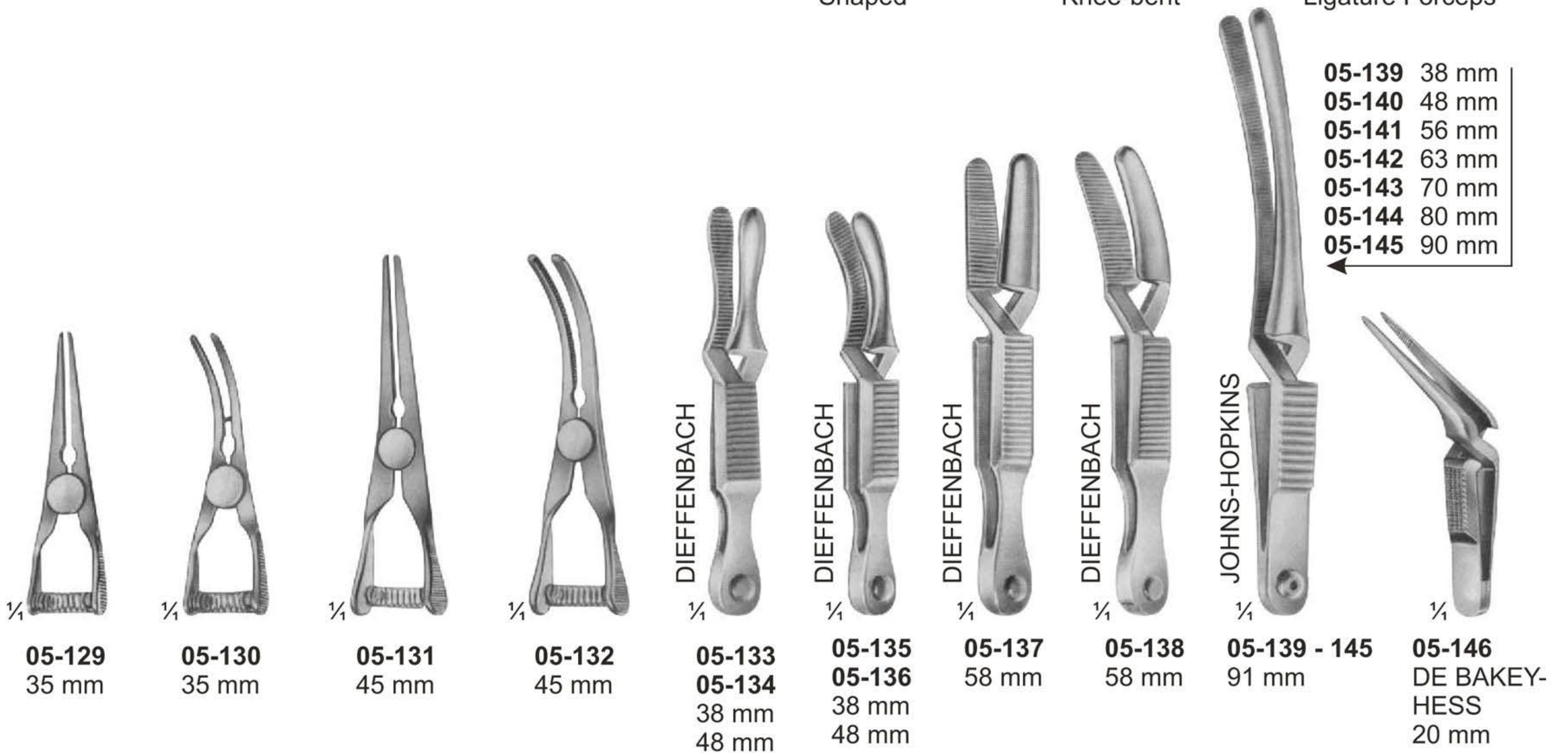
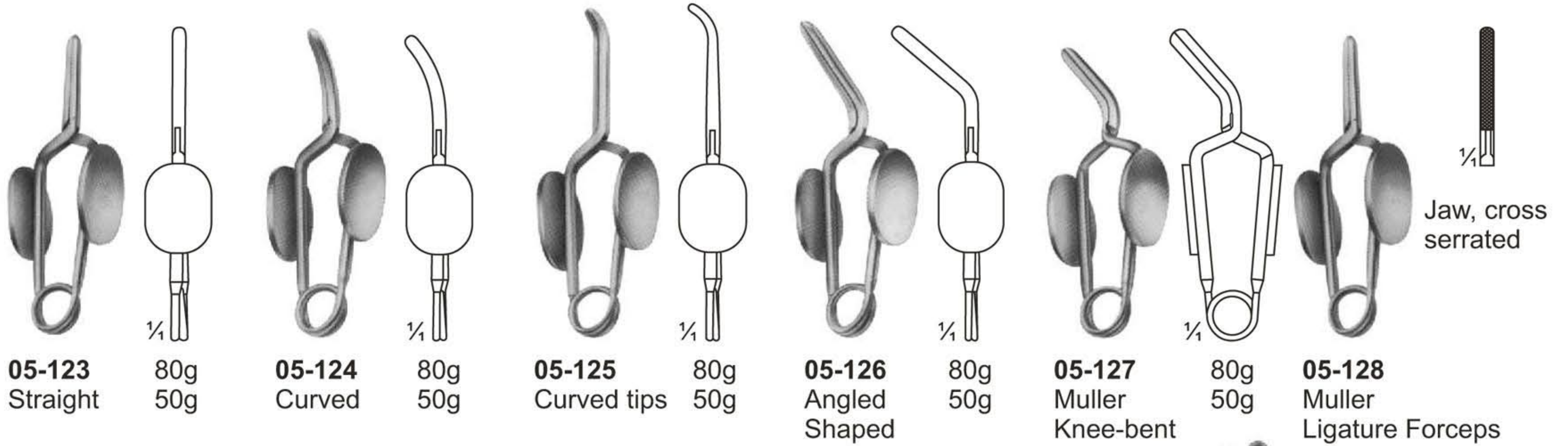



## Delicate Haemostatic Forceps

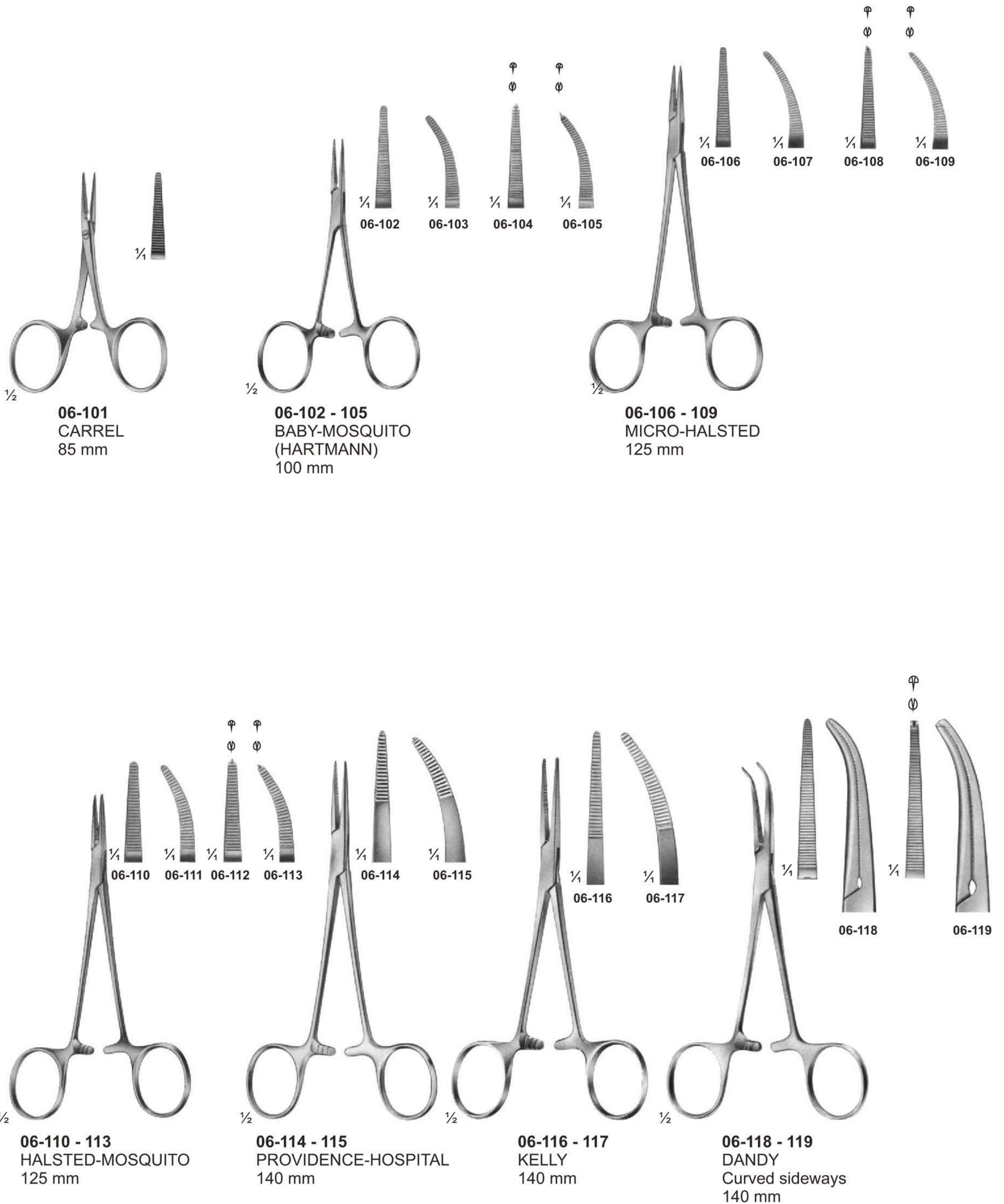



# Delicate Haemostatic Forceps

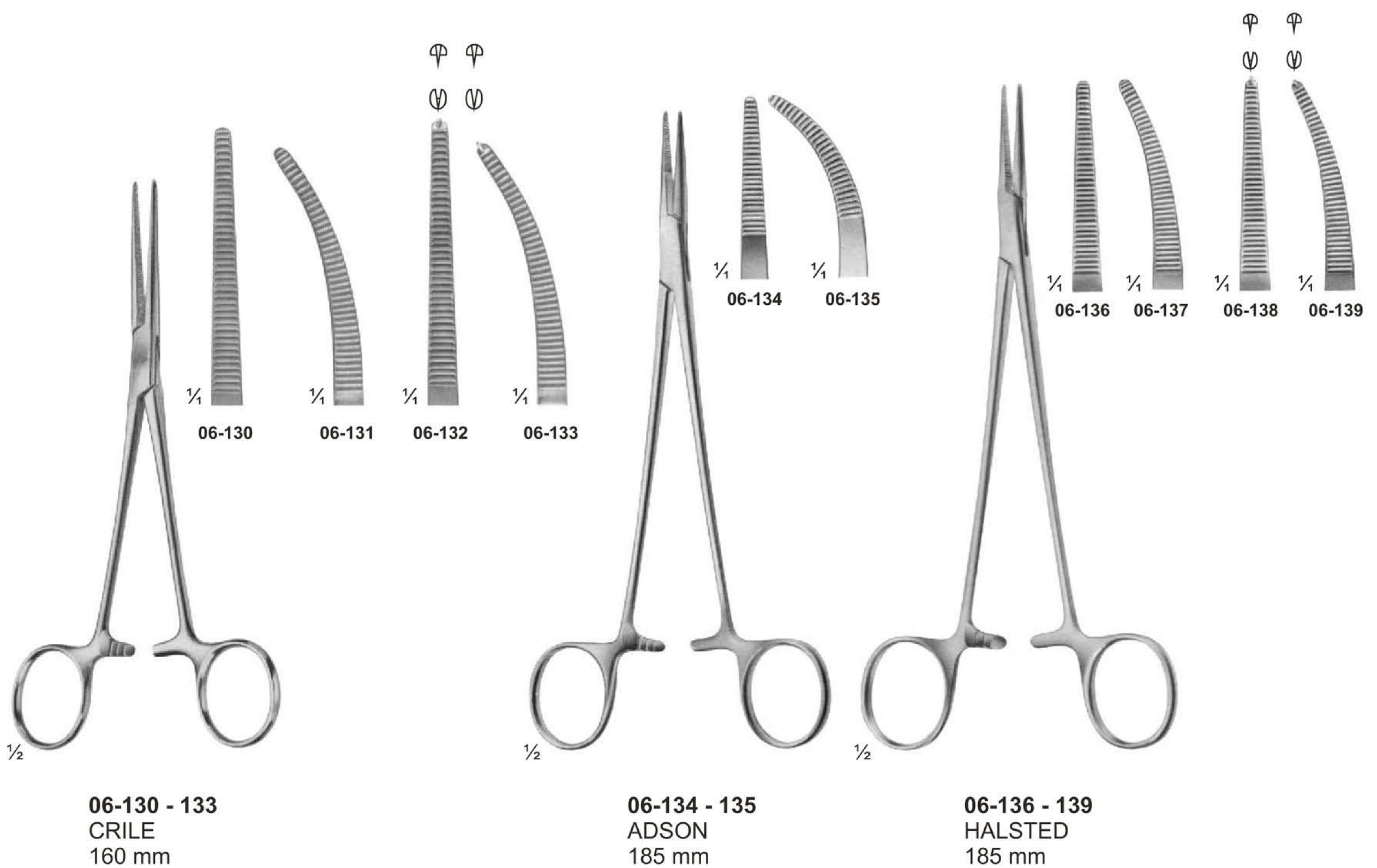
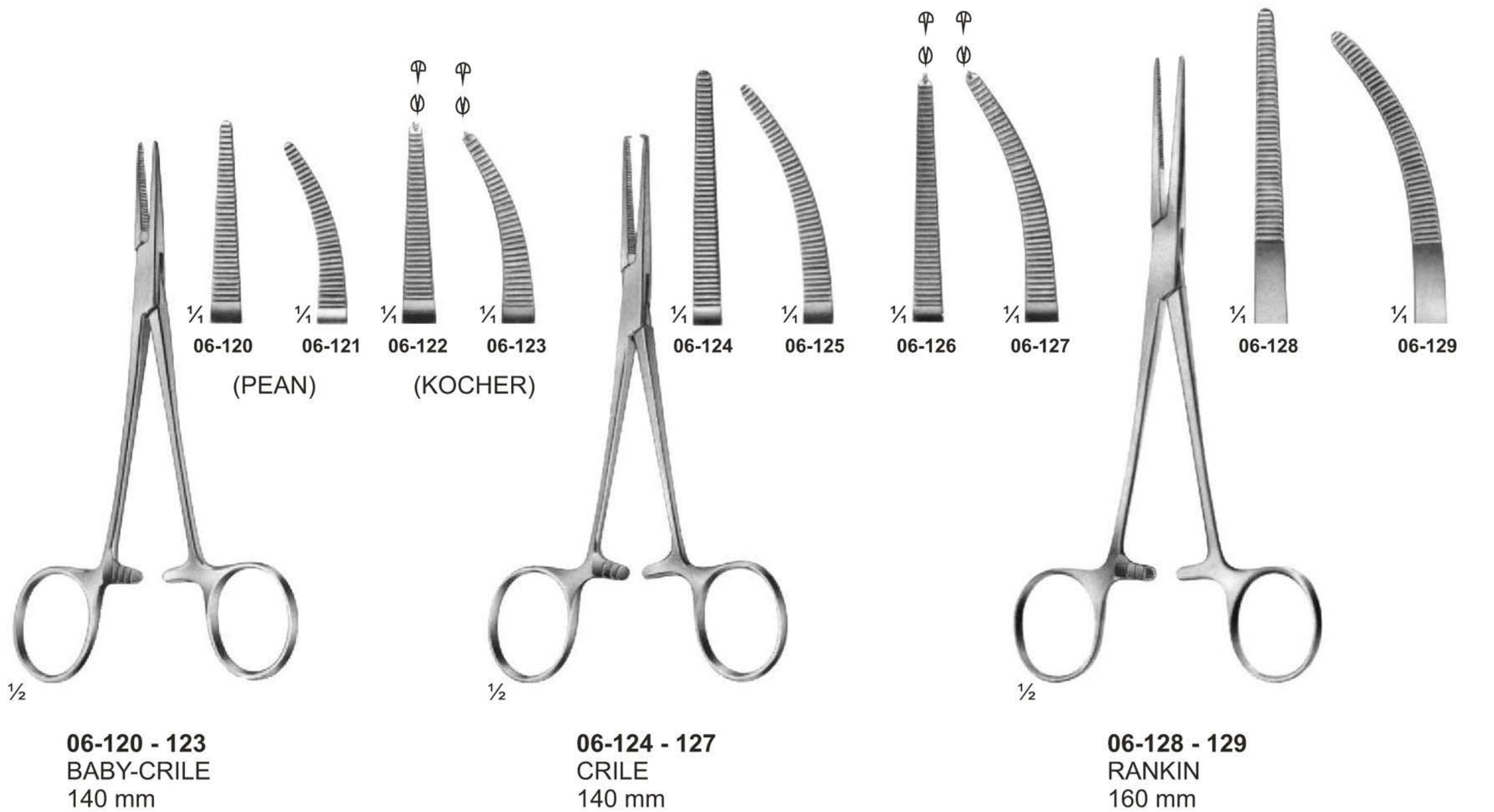



# Delicate Haemostatic Forceps

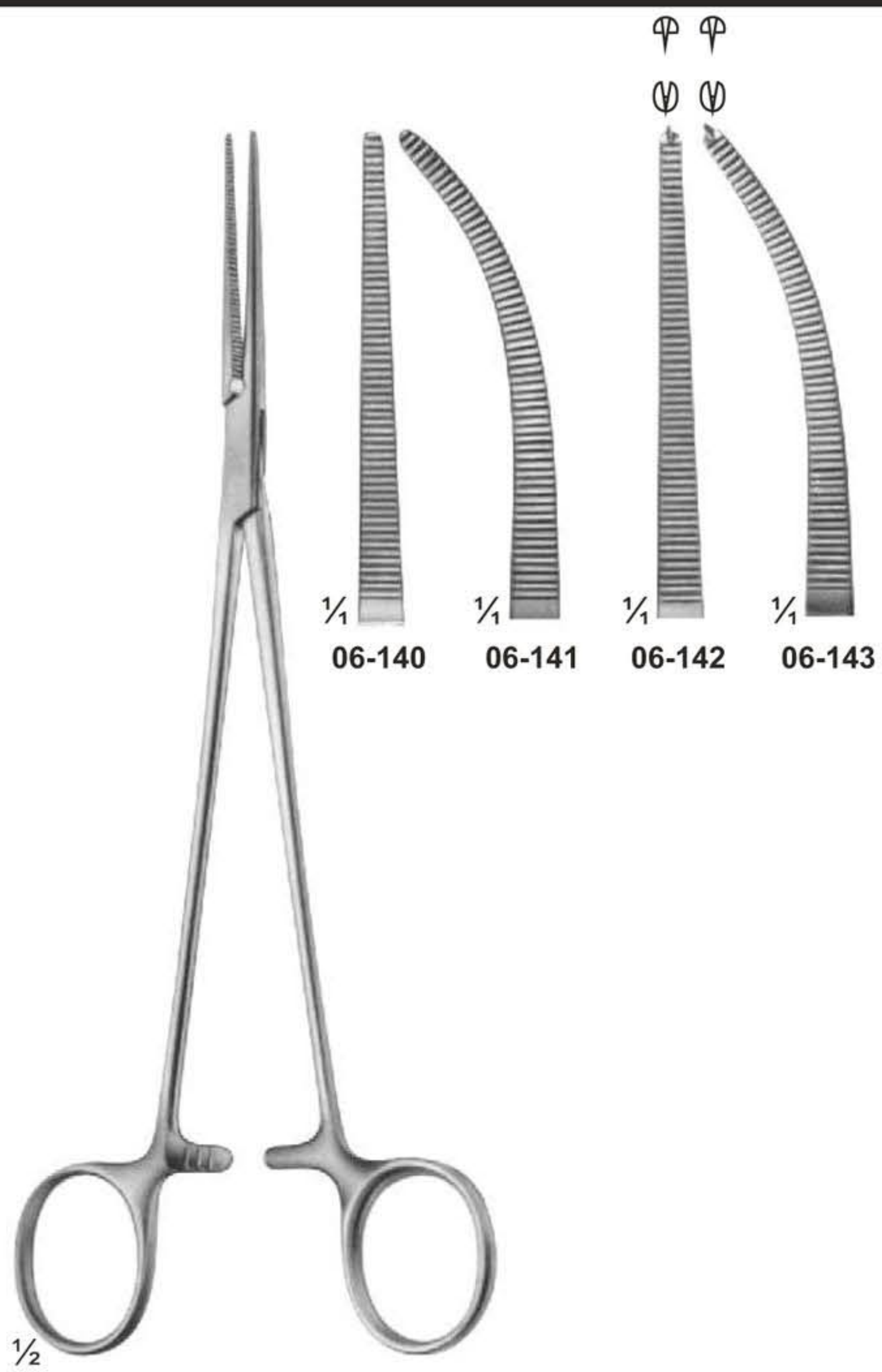

**06-140 - 143**  
HALSTED-MOSQUITO  
200 mm

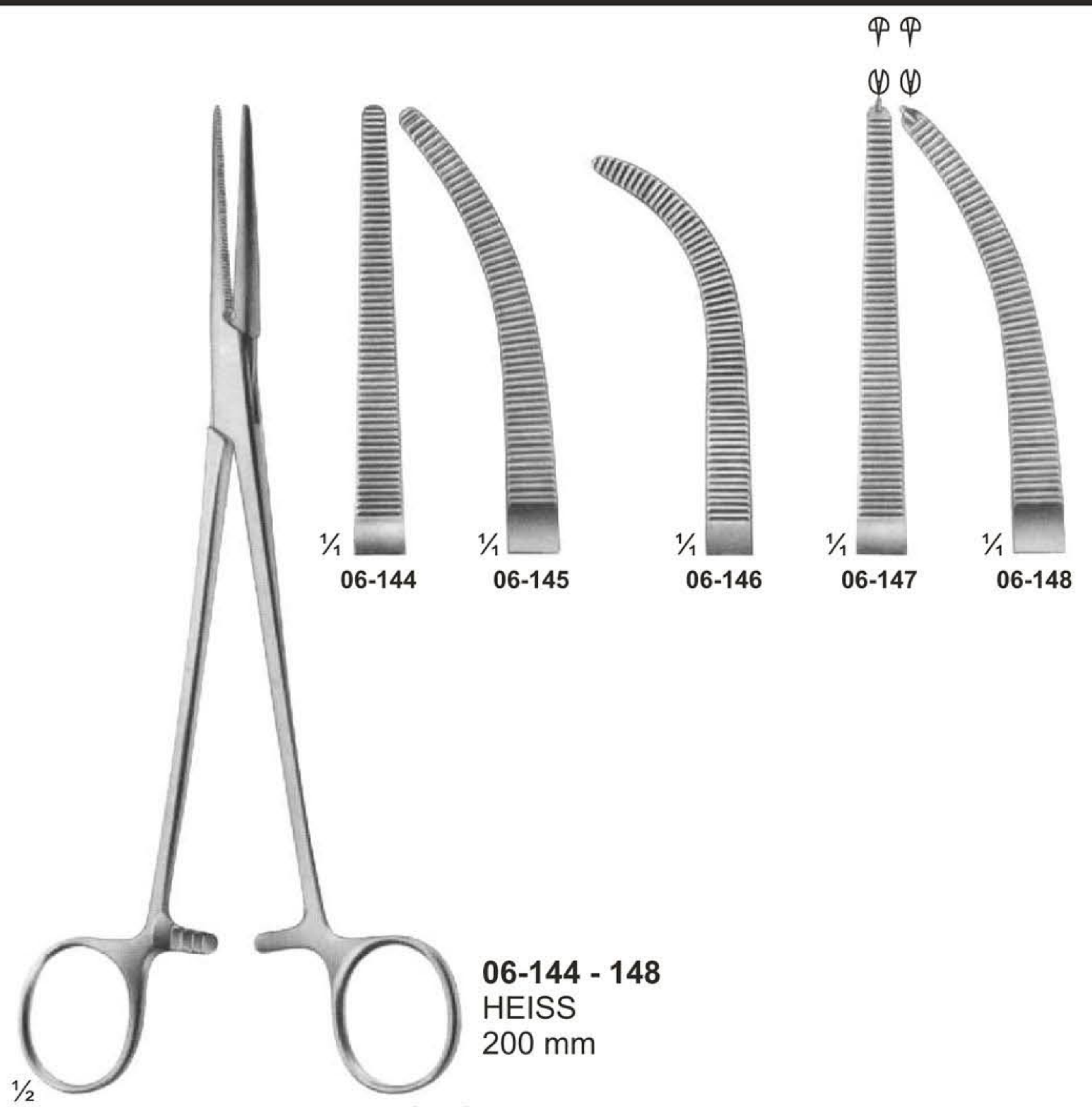

**06-144 - 148**  
HEISS  
200 mm

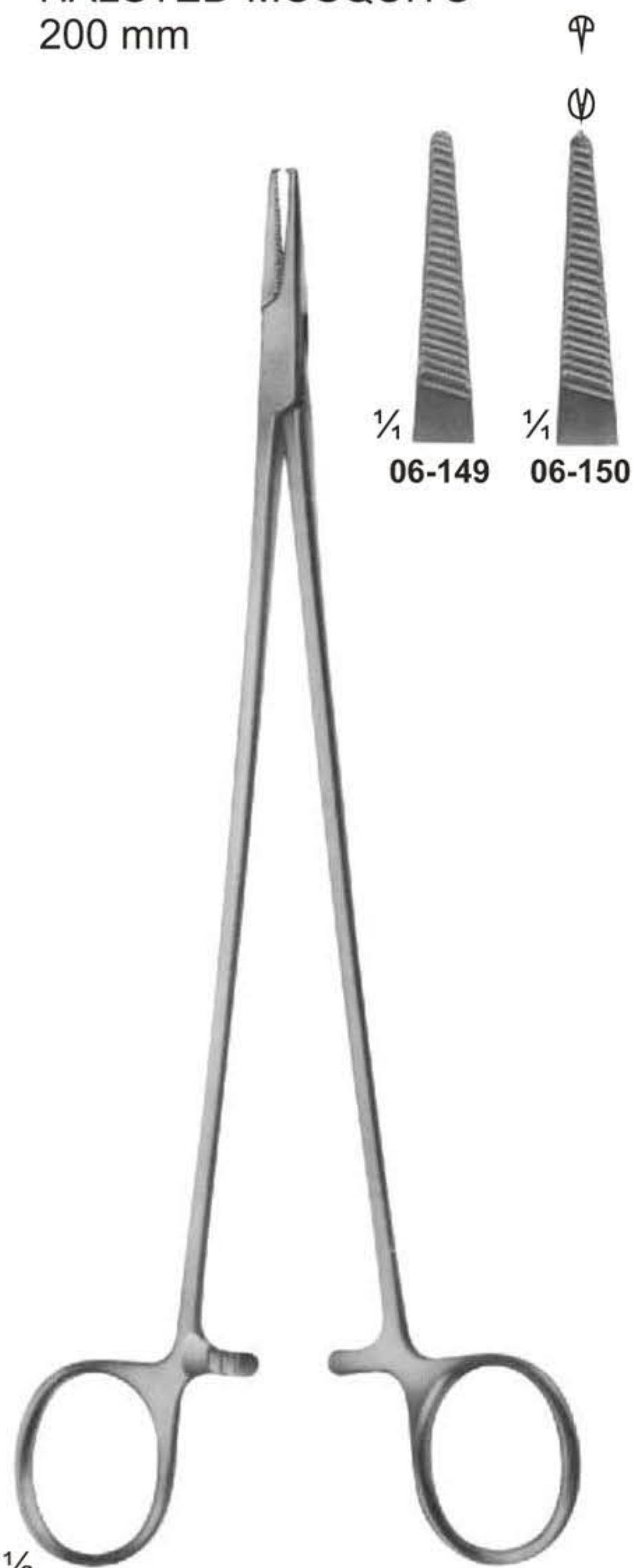

**06-149 - 150**  
HALSTED  
215 mm

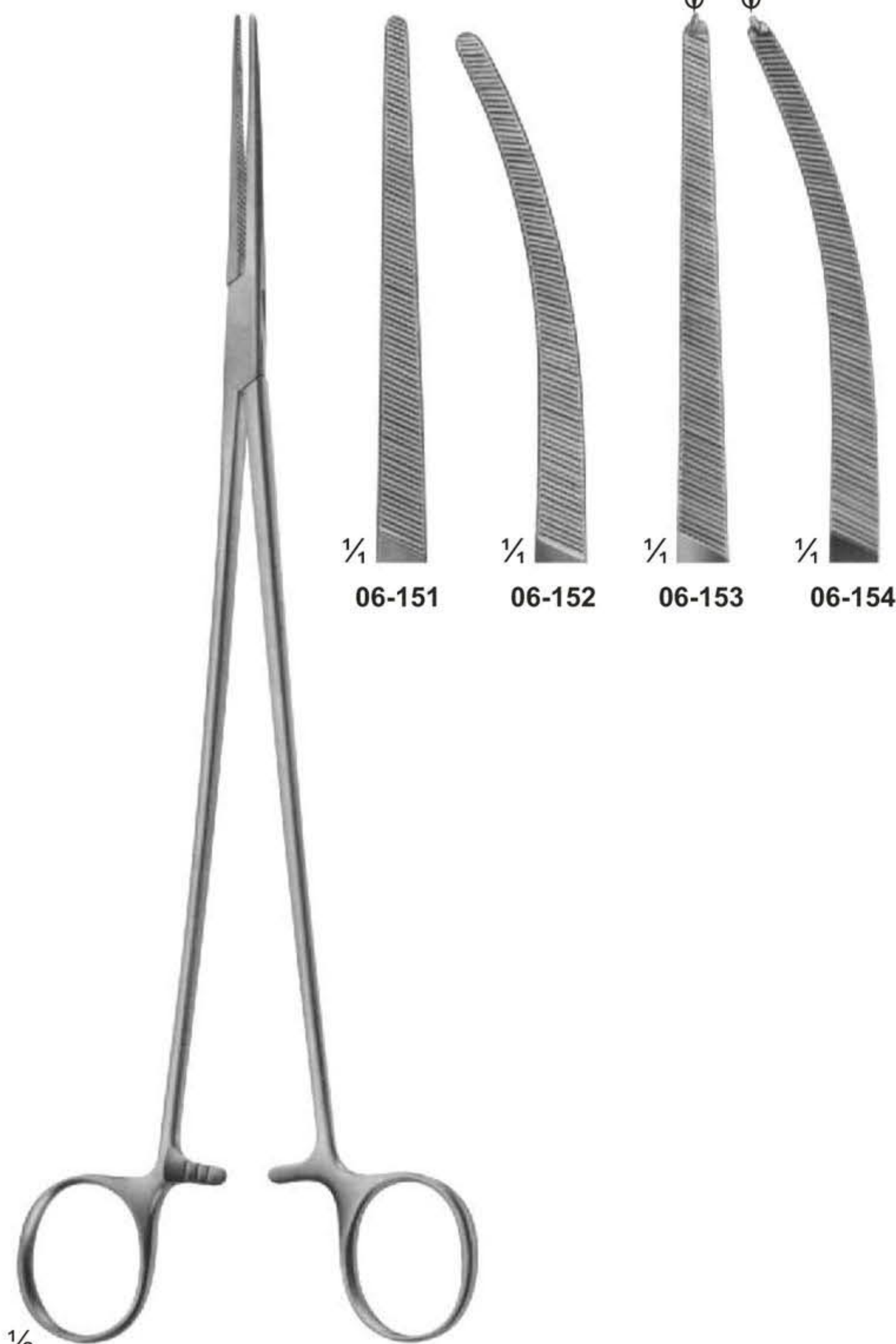

**06-151 - 154**  
BENGOLEA  
245 mm

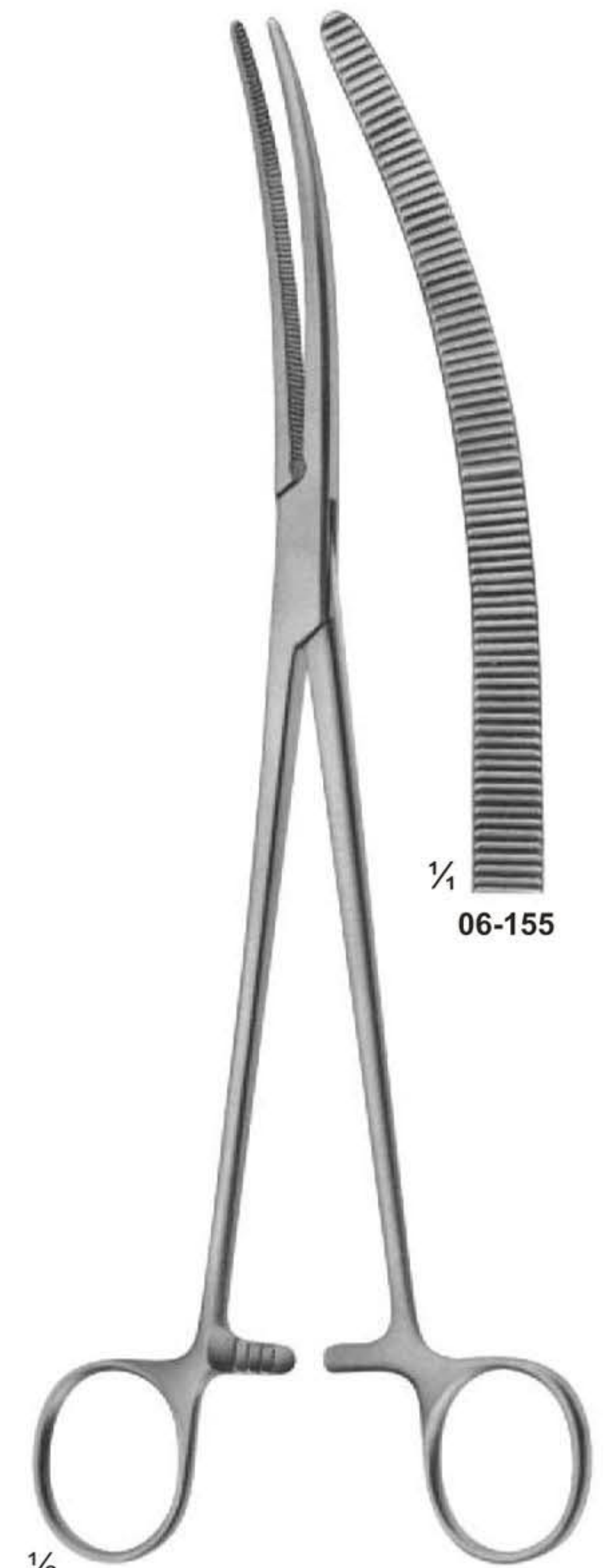

**06-155**  
CRAFOORD  
245 mm



## Haemostatic Forceps

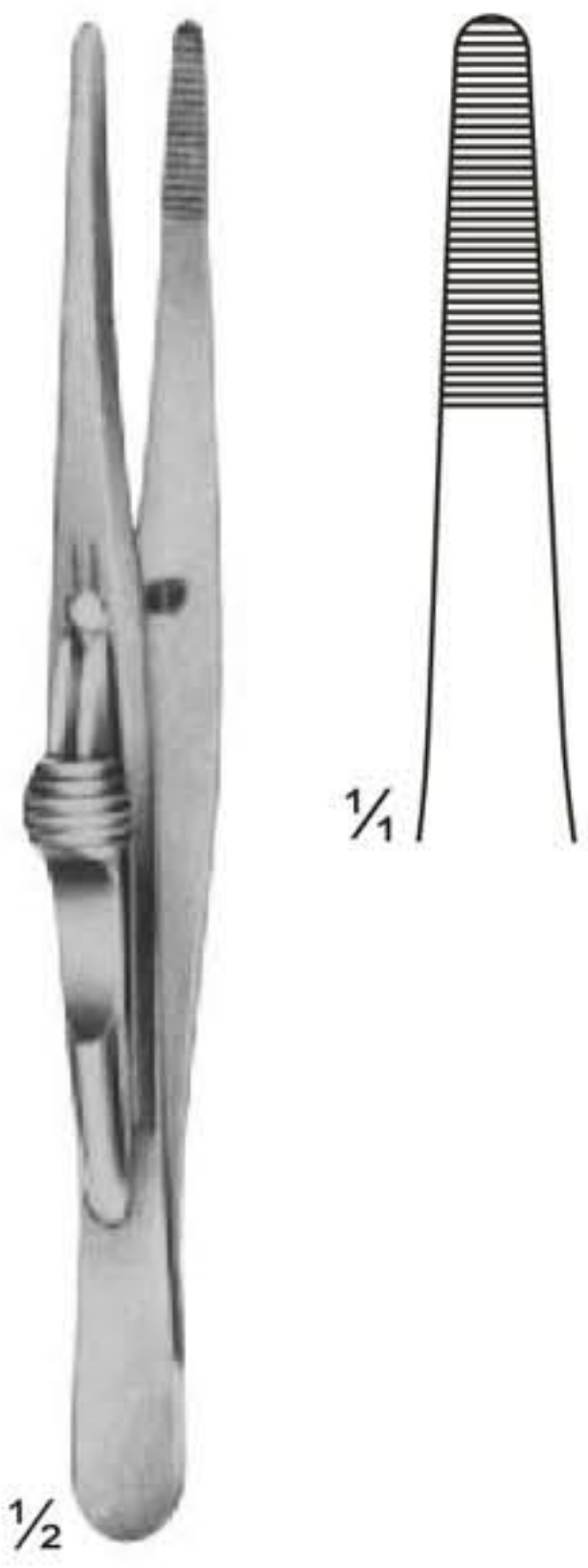

**06-156**  
FRICKE  
Artery forceps  
130 mm

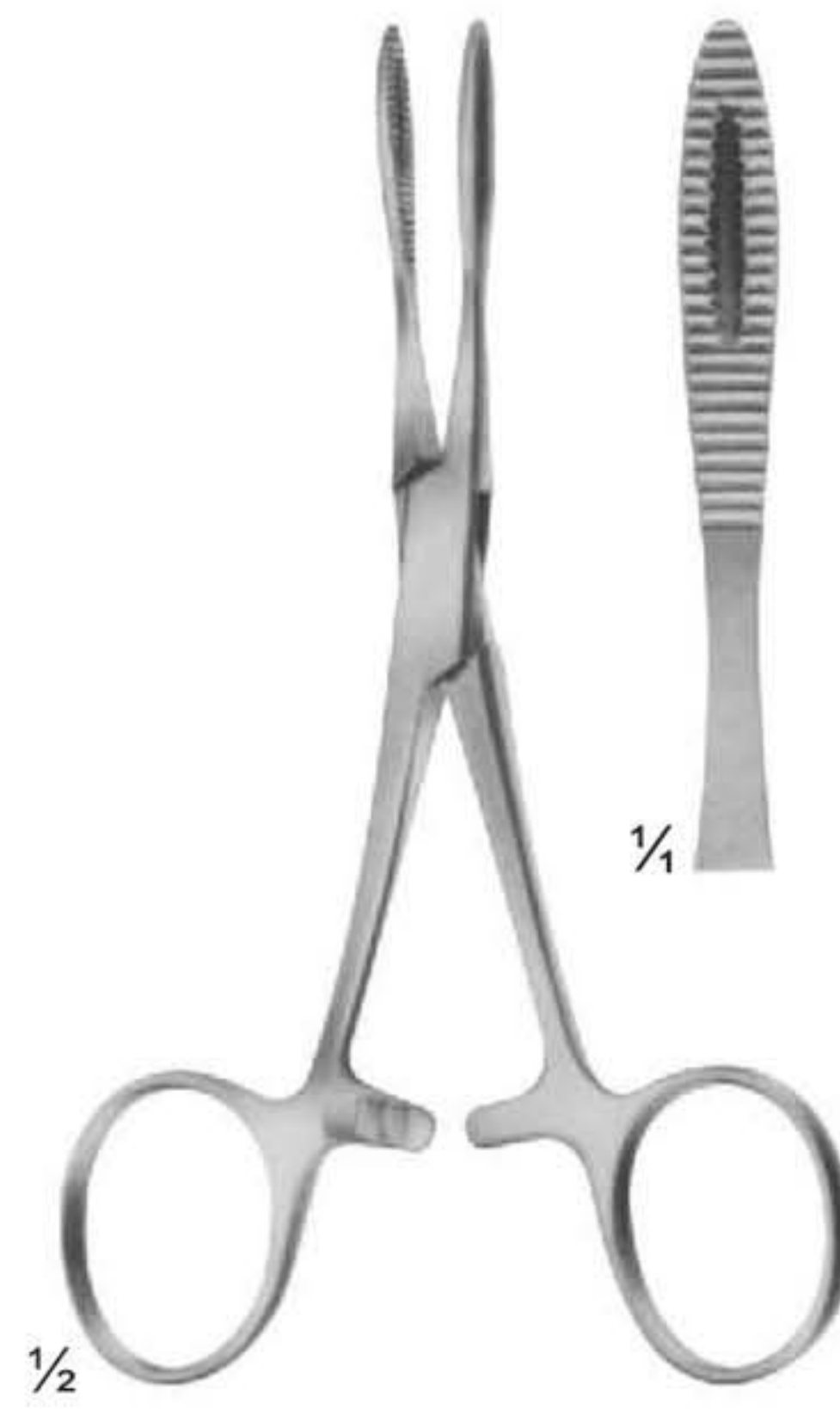

**06-157**  
KRONLEIN  
130 mm

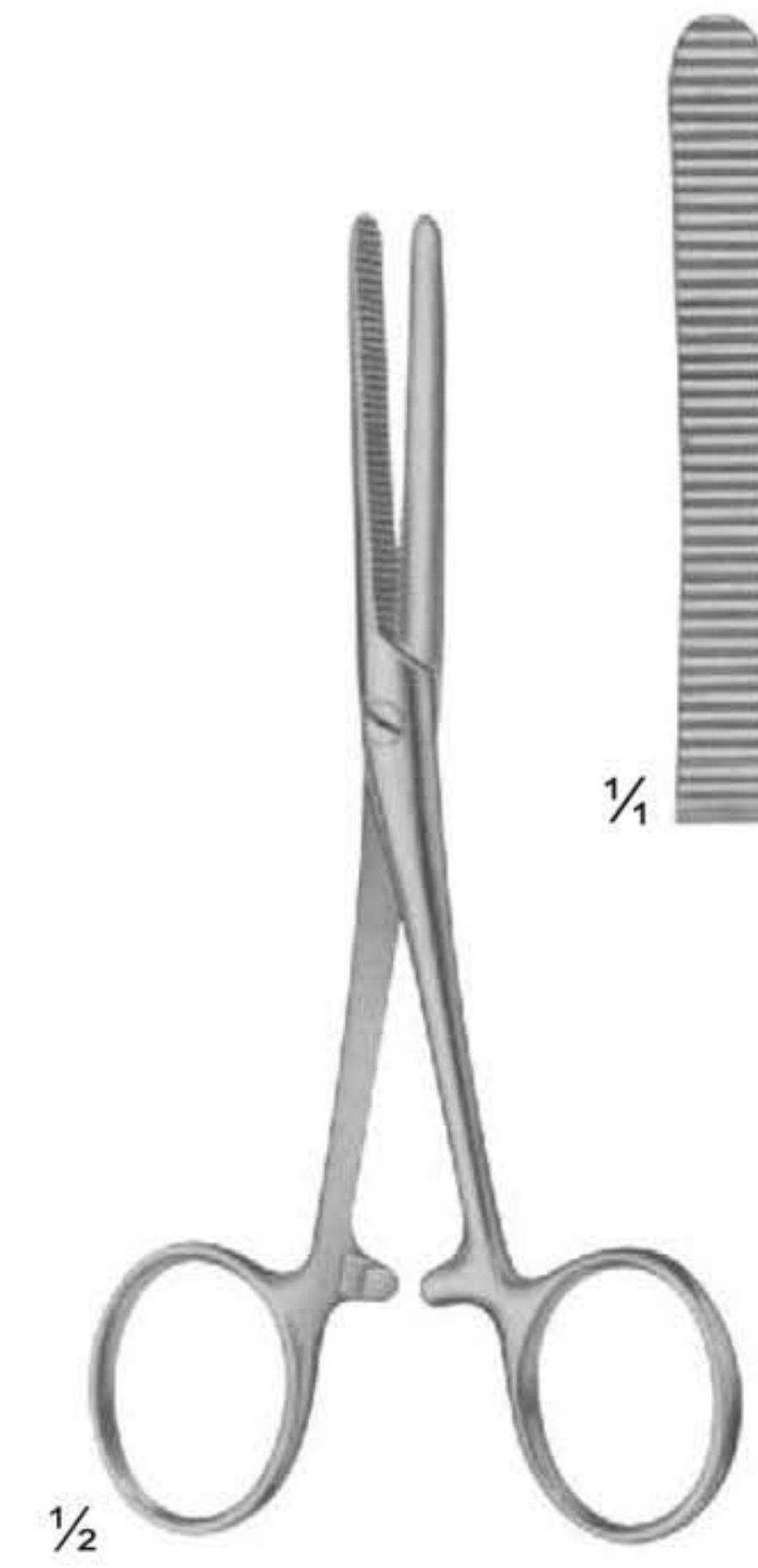

**06-158**  
PEAN  
125 mm



**06-159 - 160**  
PEAN

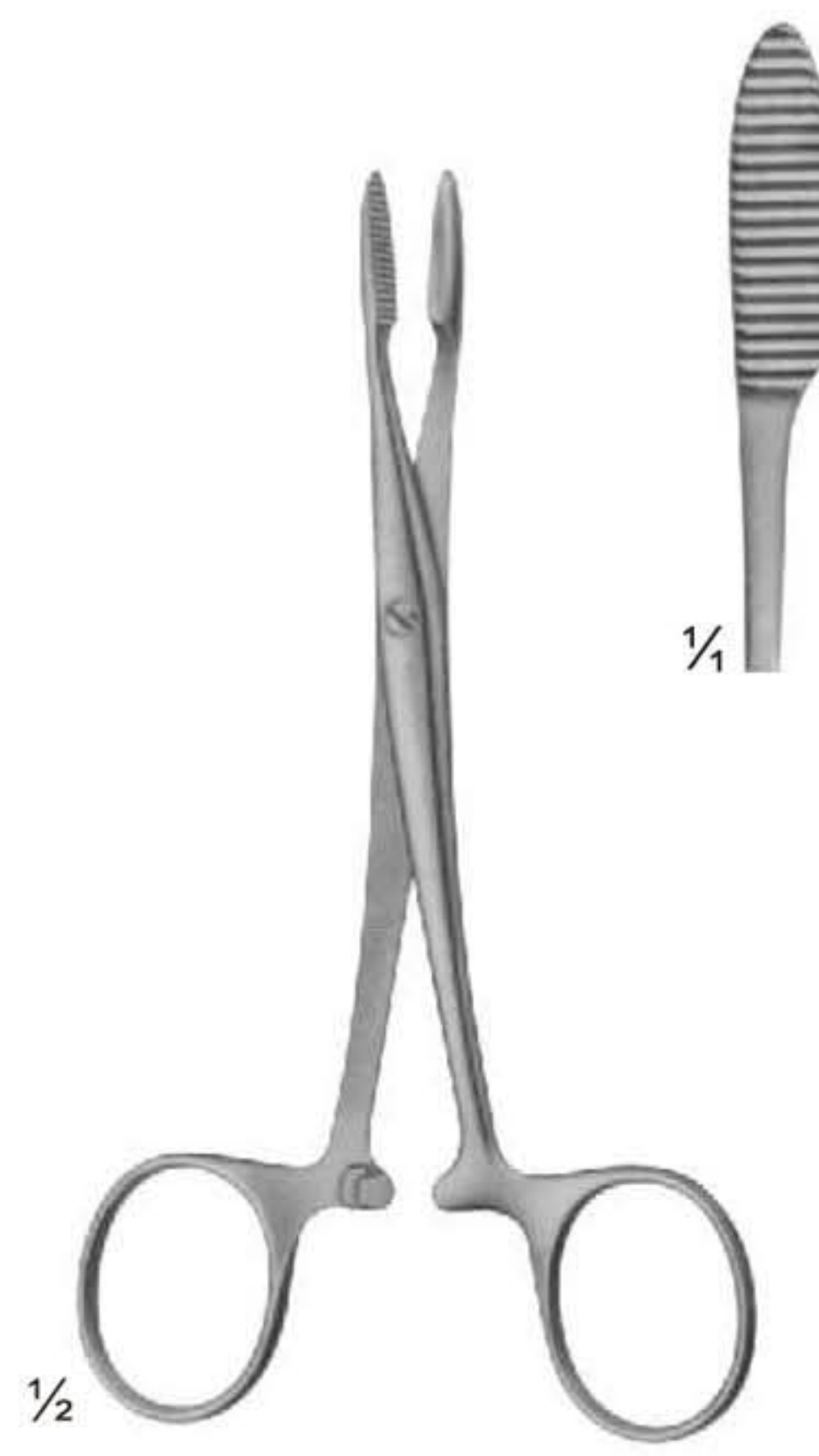

**06-161**  
PEAN

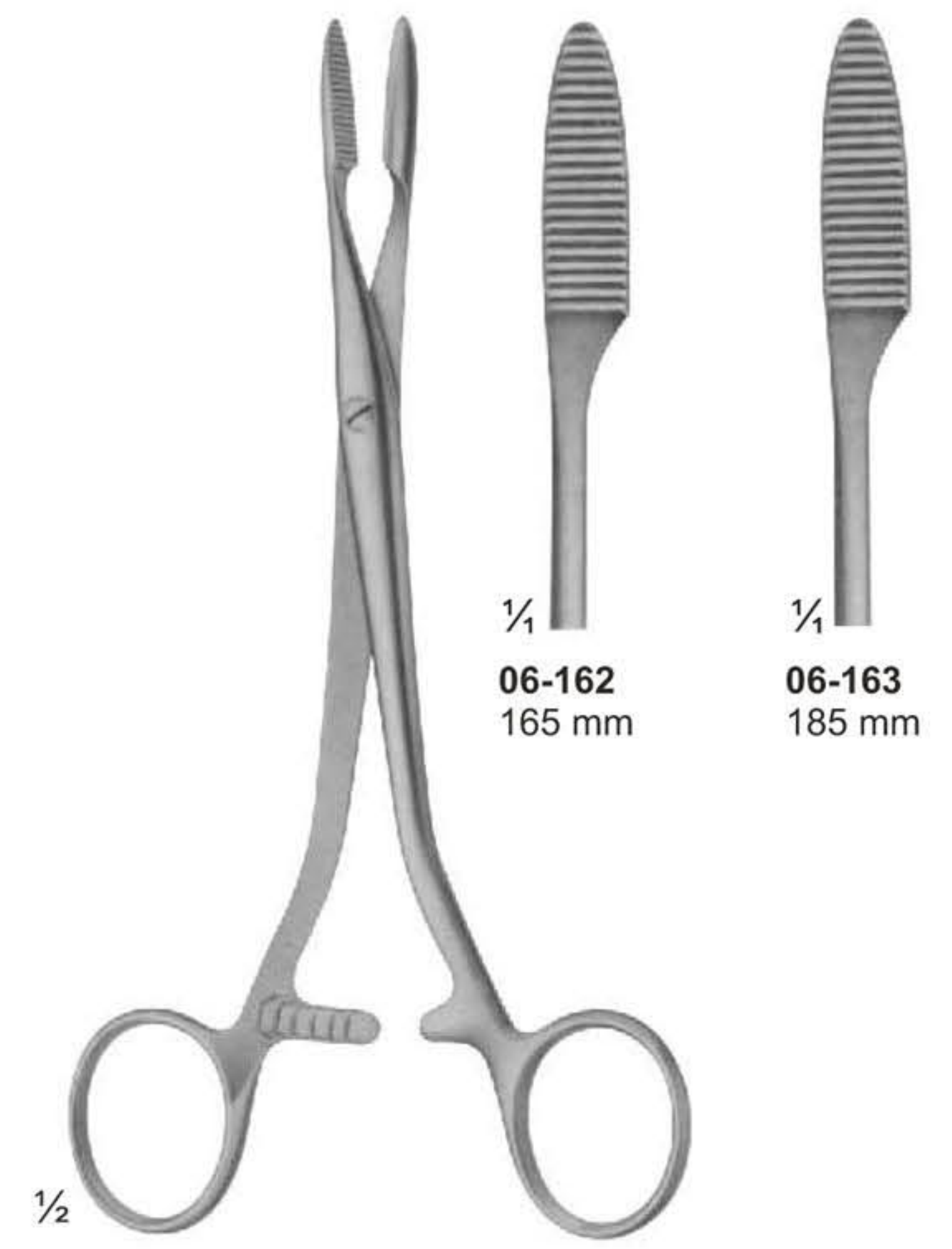

**06-162 - 163**  
PEAN



# Haemostatic Forceps

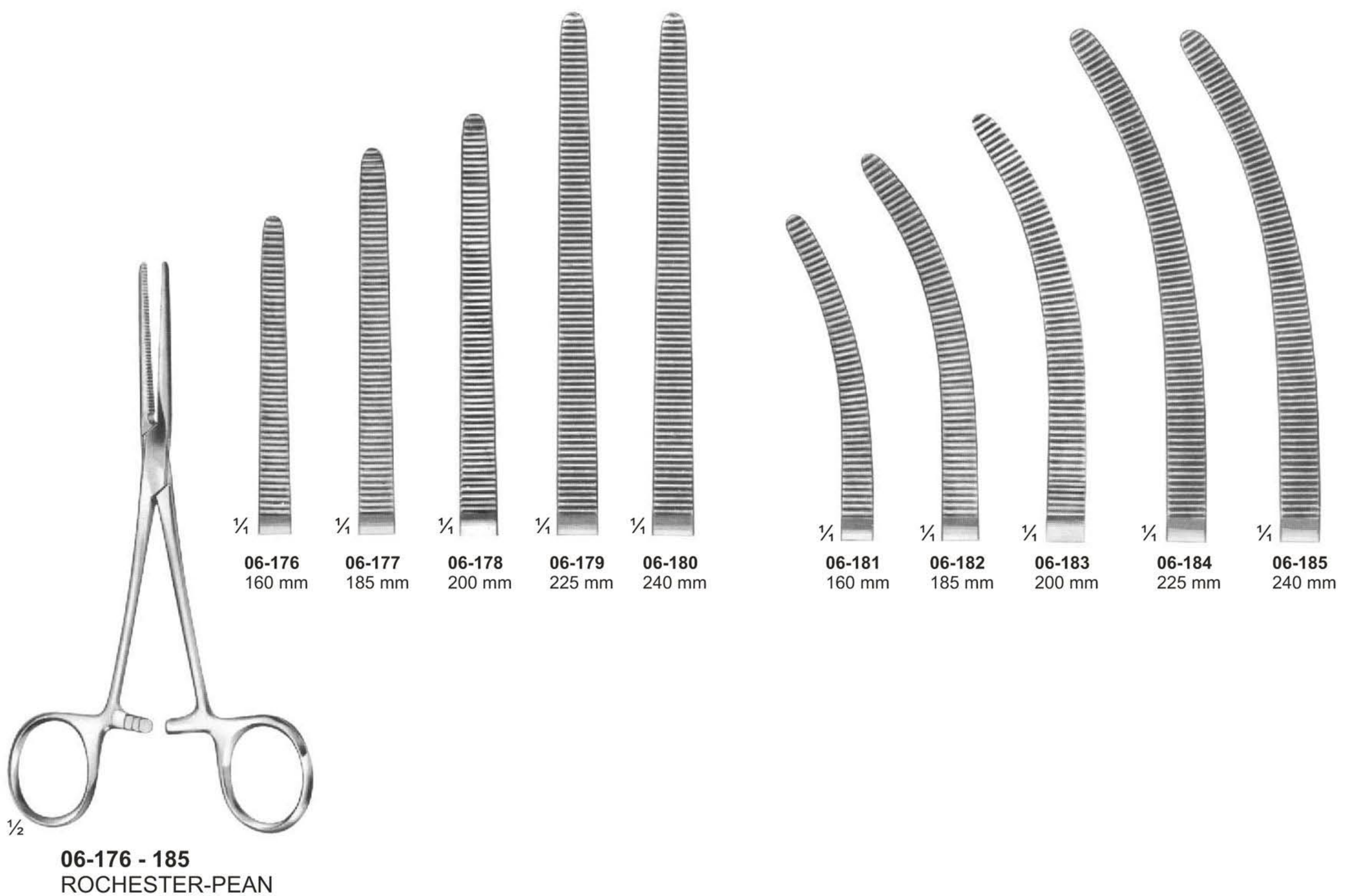
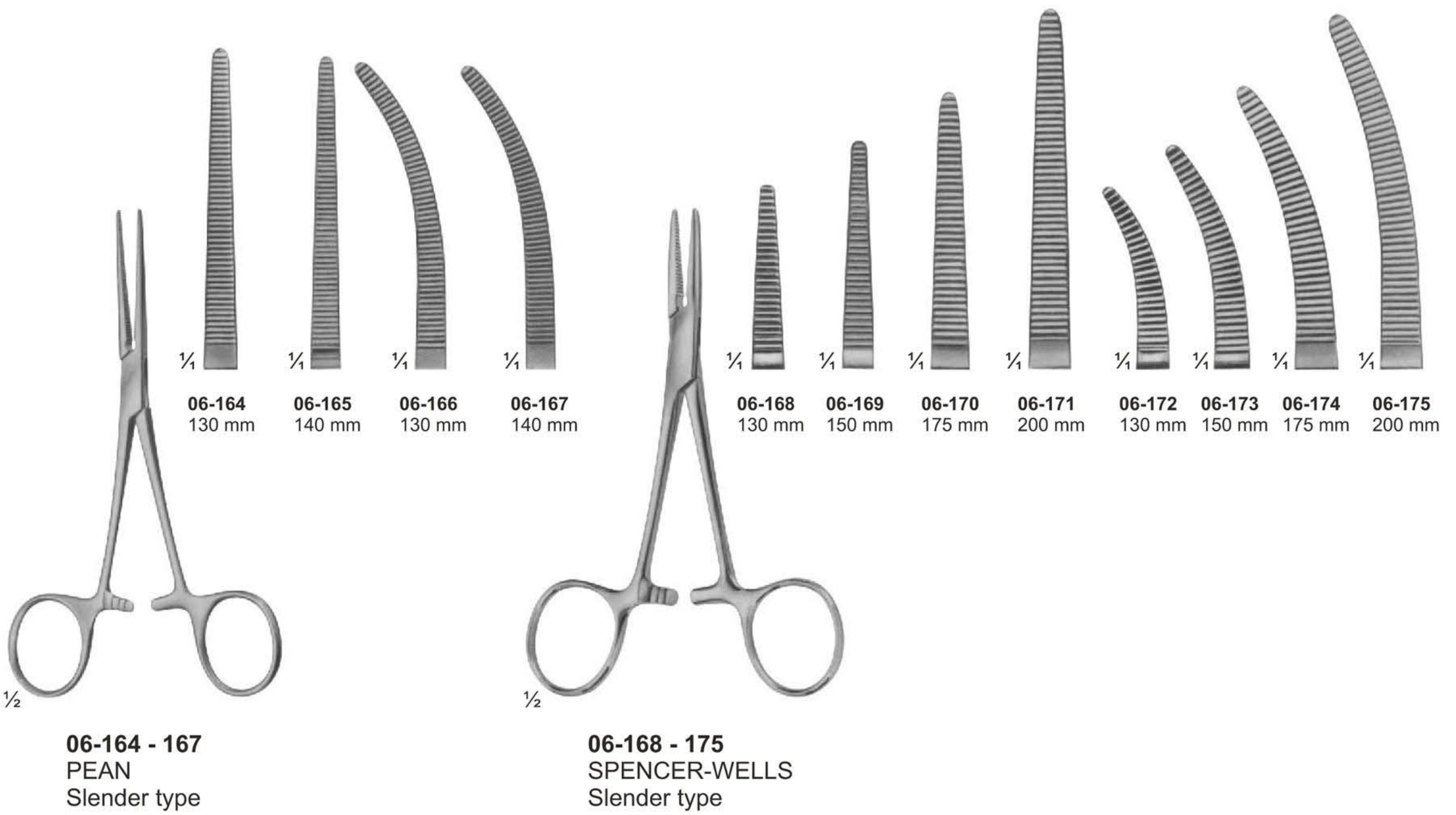



**Haemostatic Forceps**



**06-186 - 191**  
PEAN

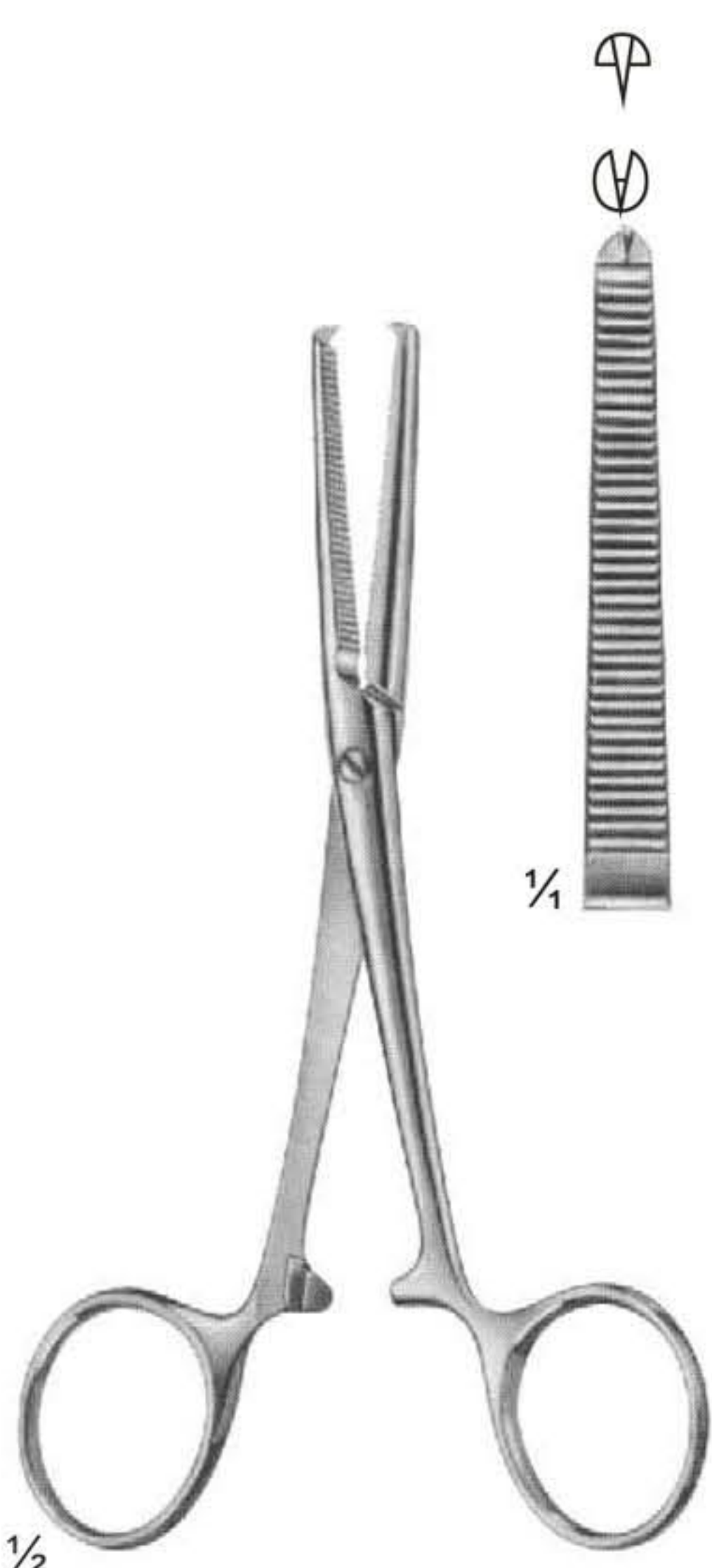
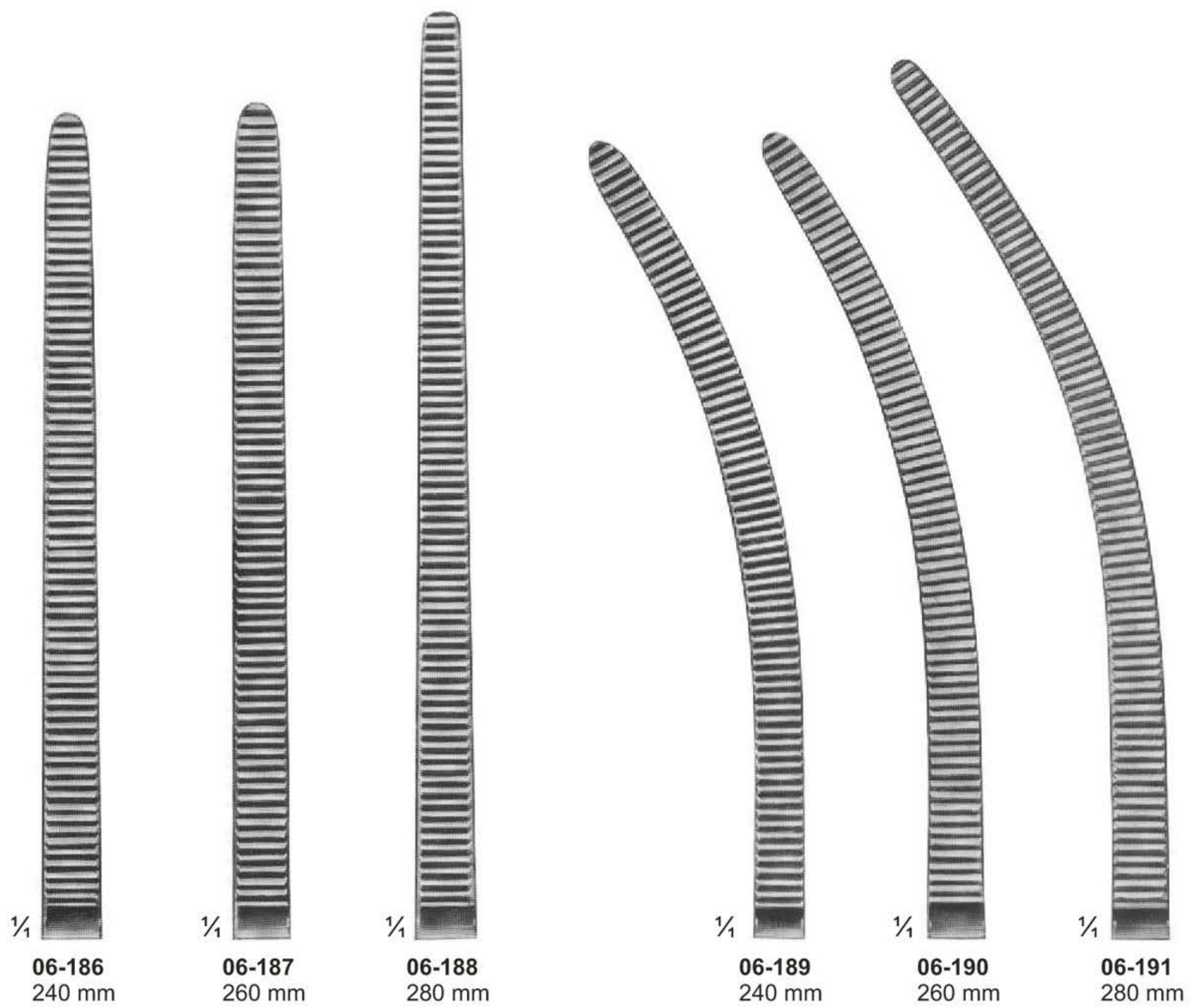

**06-192**  
KOCHER  
Strong Pattern  
145 mm

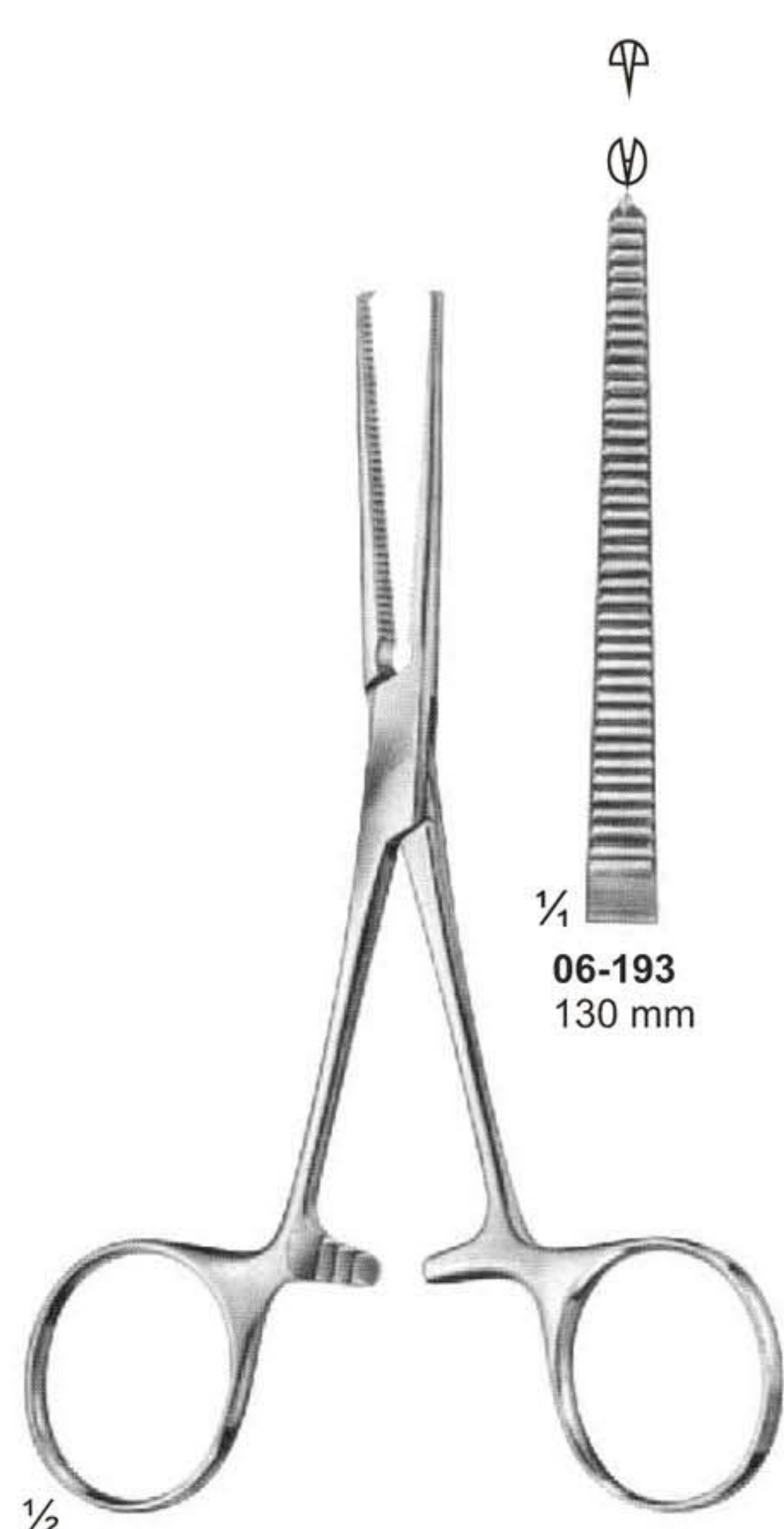

**06-193 - 195**  
KOCHER

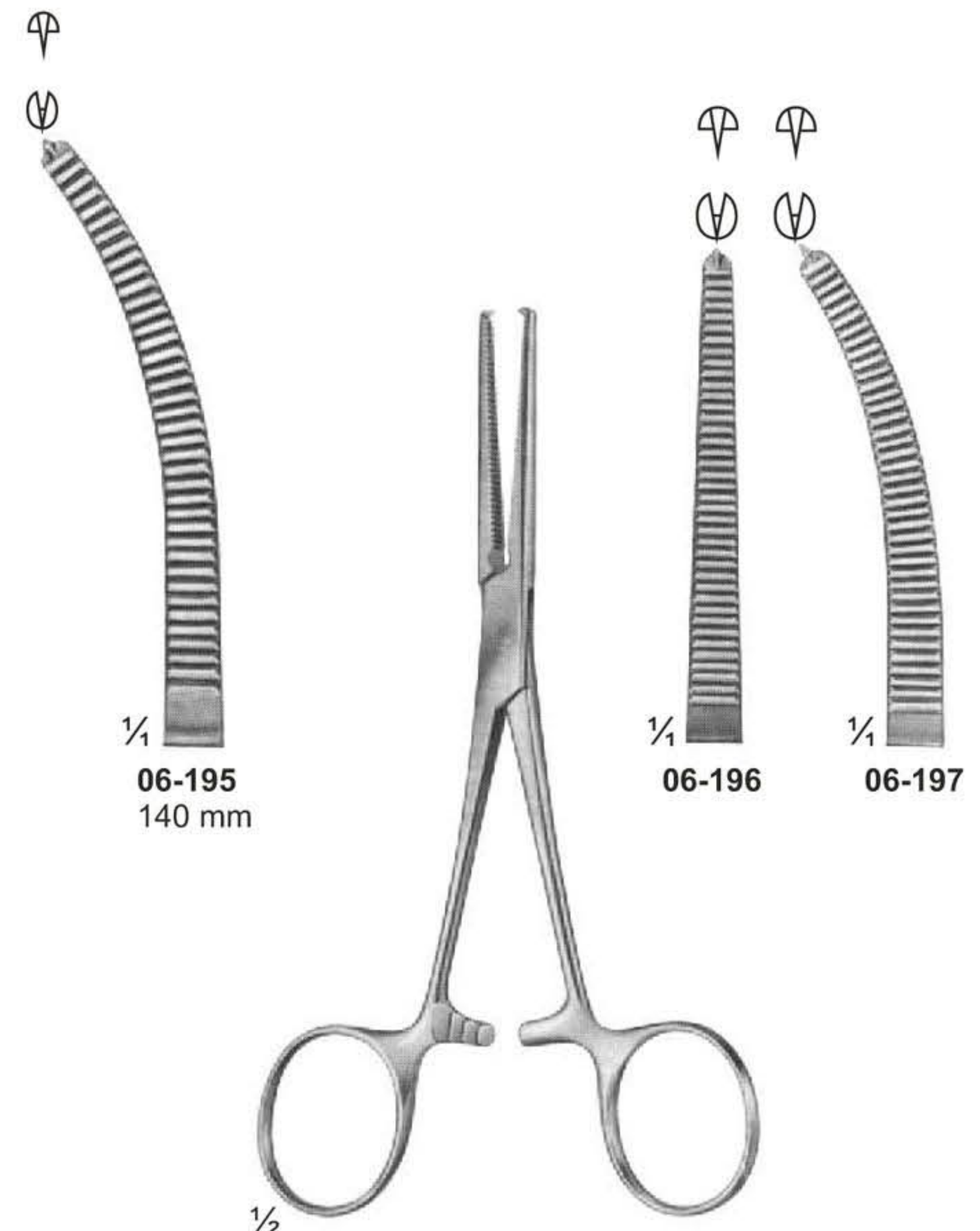

**06-196 - 197**  
ROCHESTER-OSHSNER  
140 mm



# Haemostatic Forceps

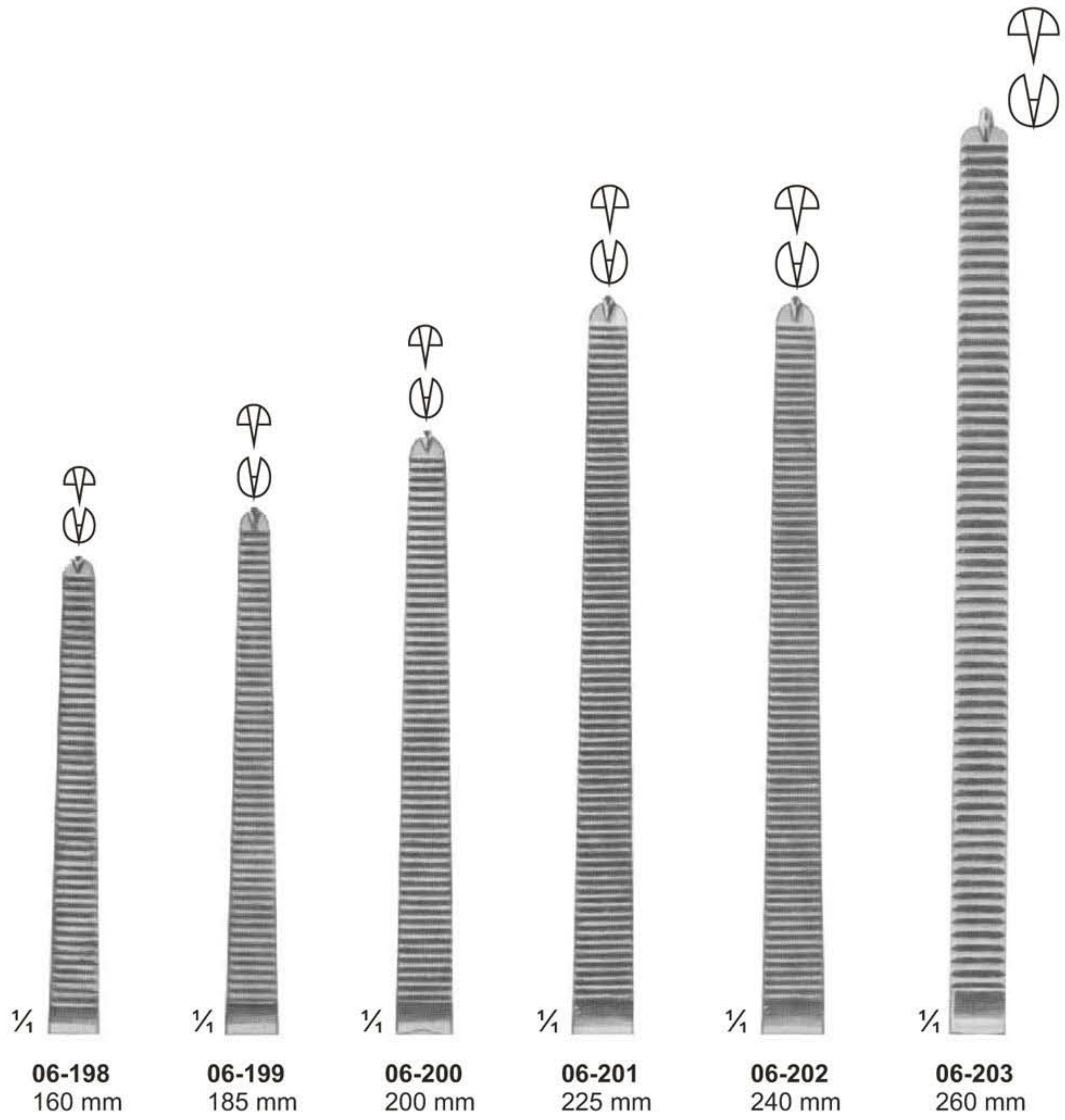

**06-198 - 209**  
KOCHER-OCHSNER

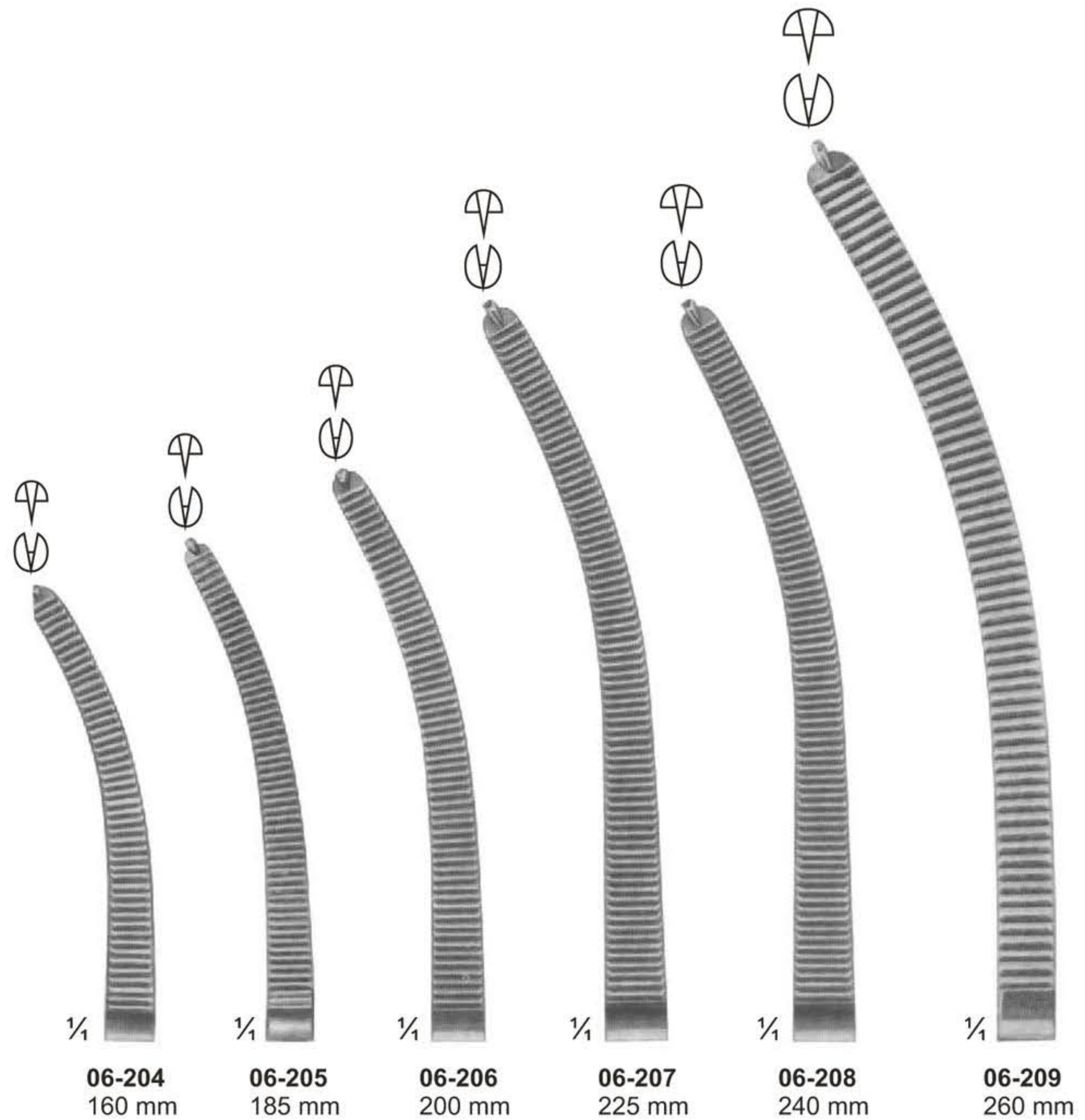



**Haemostatic Forceps, Special Pattern, Tonsil Forceps**

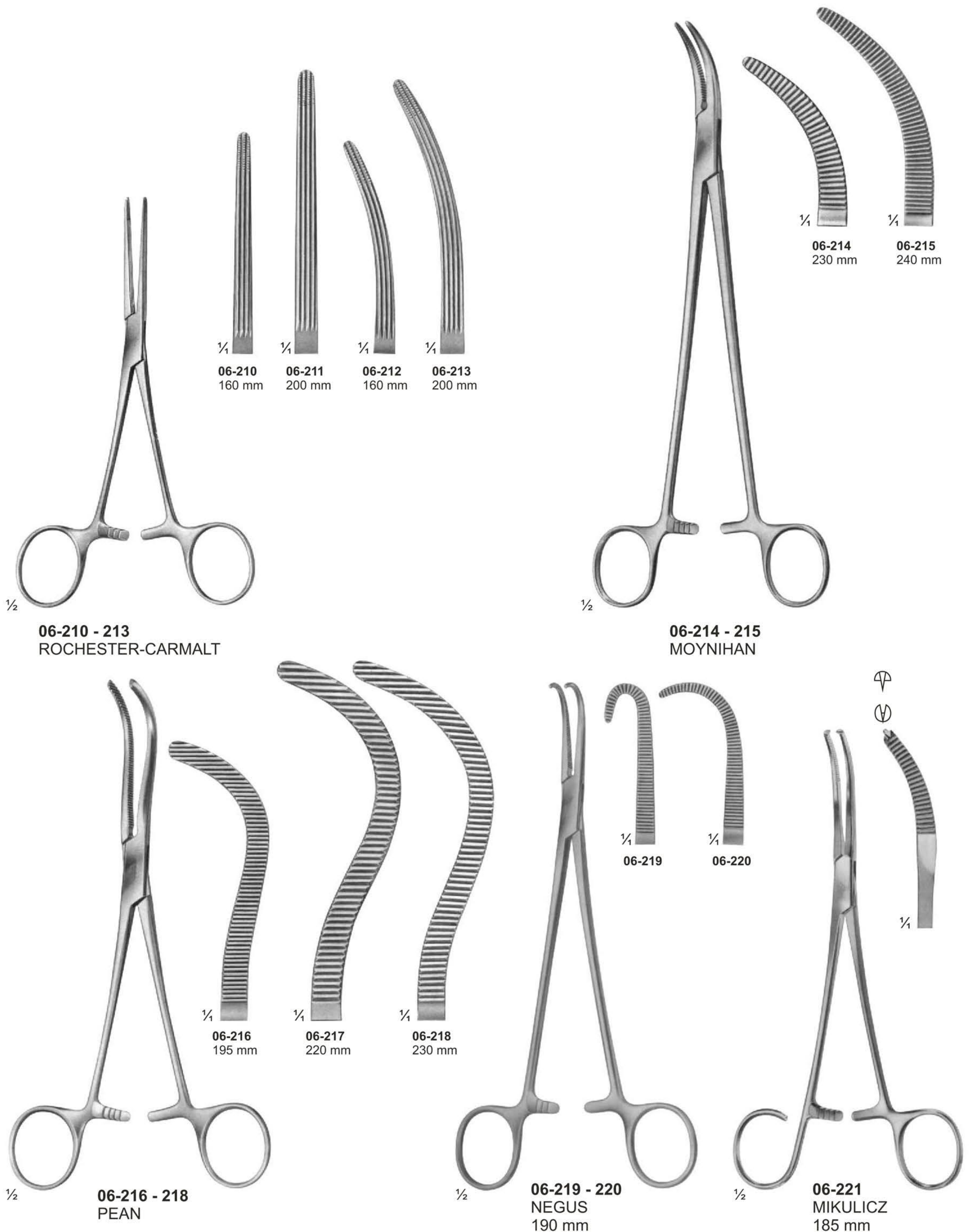



# Dissecting- and Ligature Forceps

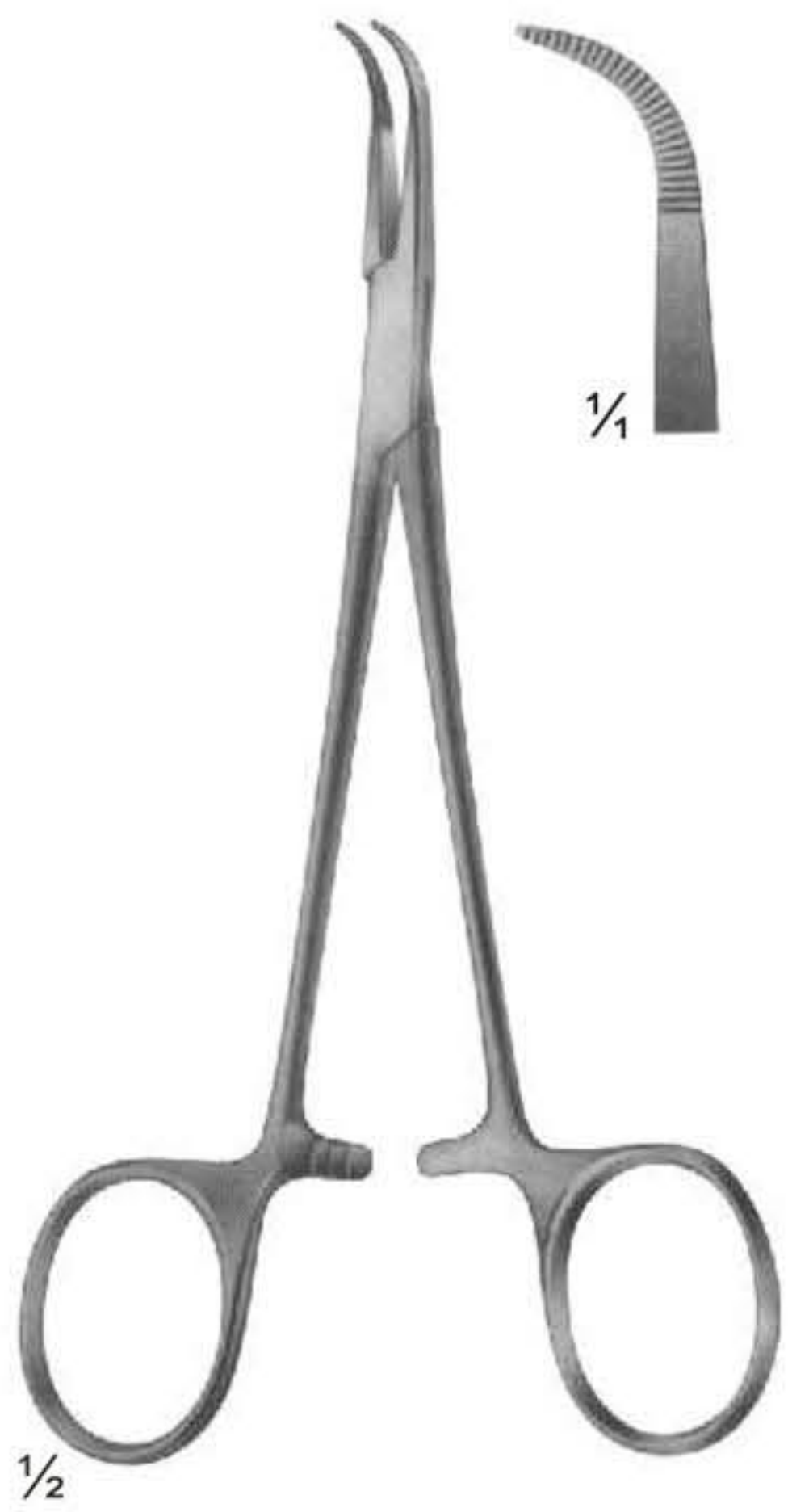

**06-222**  
MICRO-ADSON  
140 mm

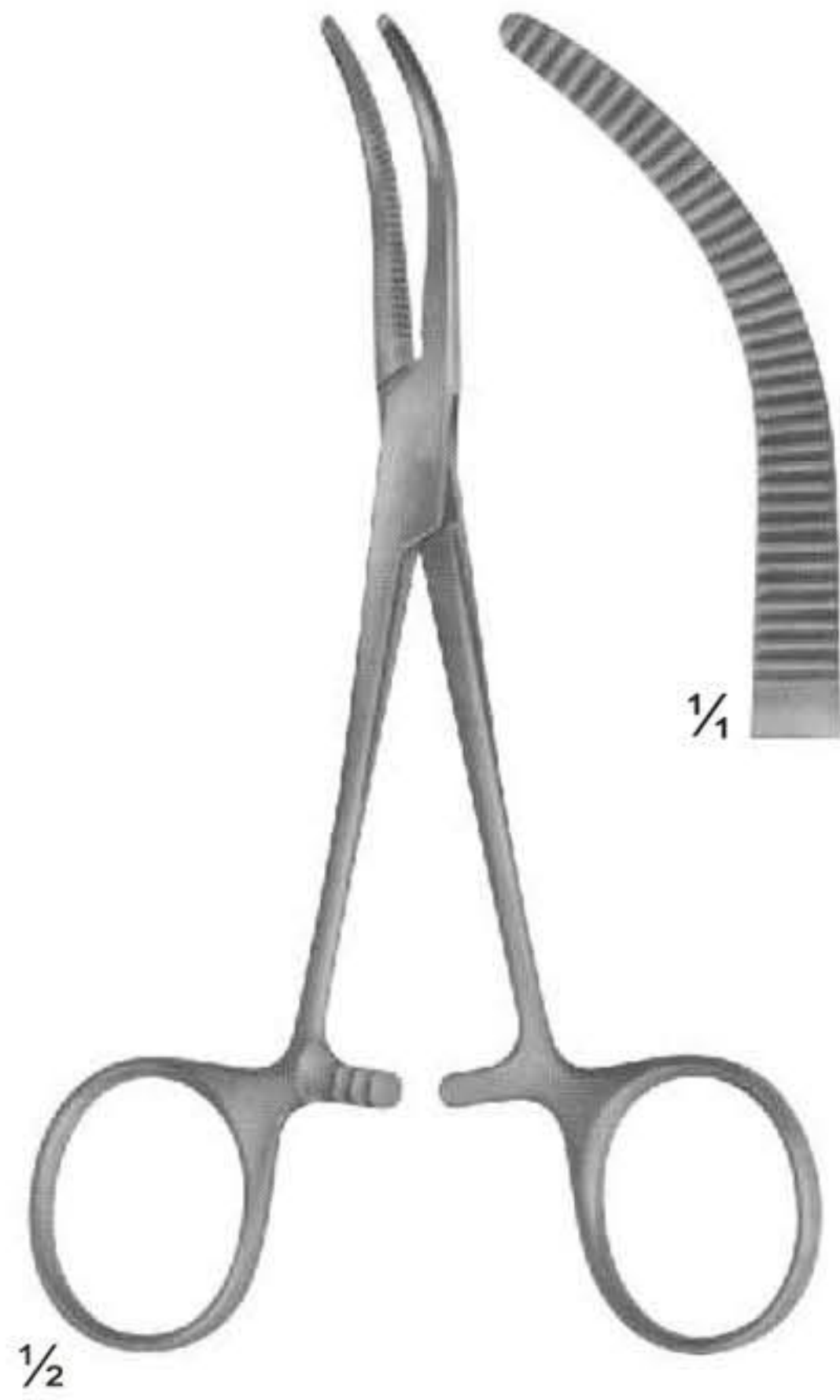

**06-223**  
BABY-OVERHOLT  
135 mm



**06-224 - 225**  
BABY-MIXTER

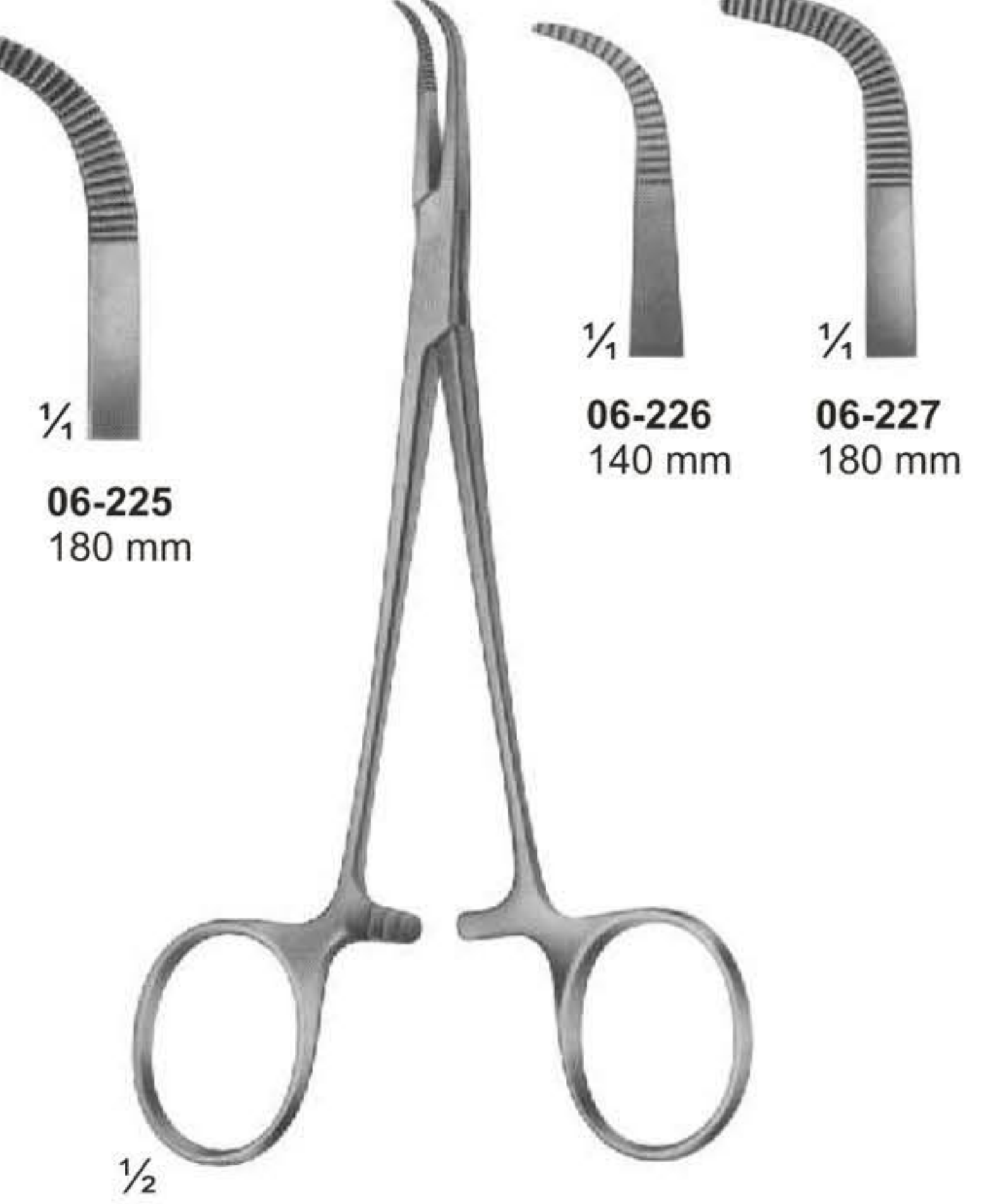

**06-226 - 227**  
BABY-ADSON

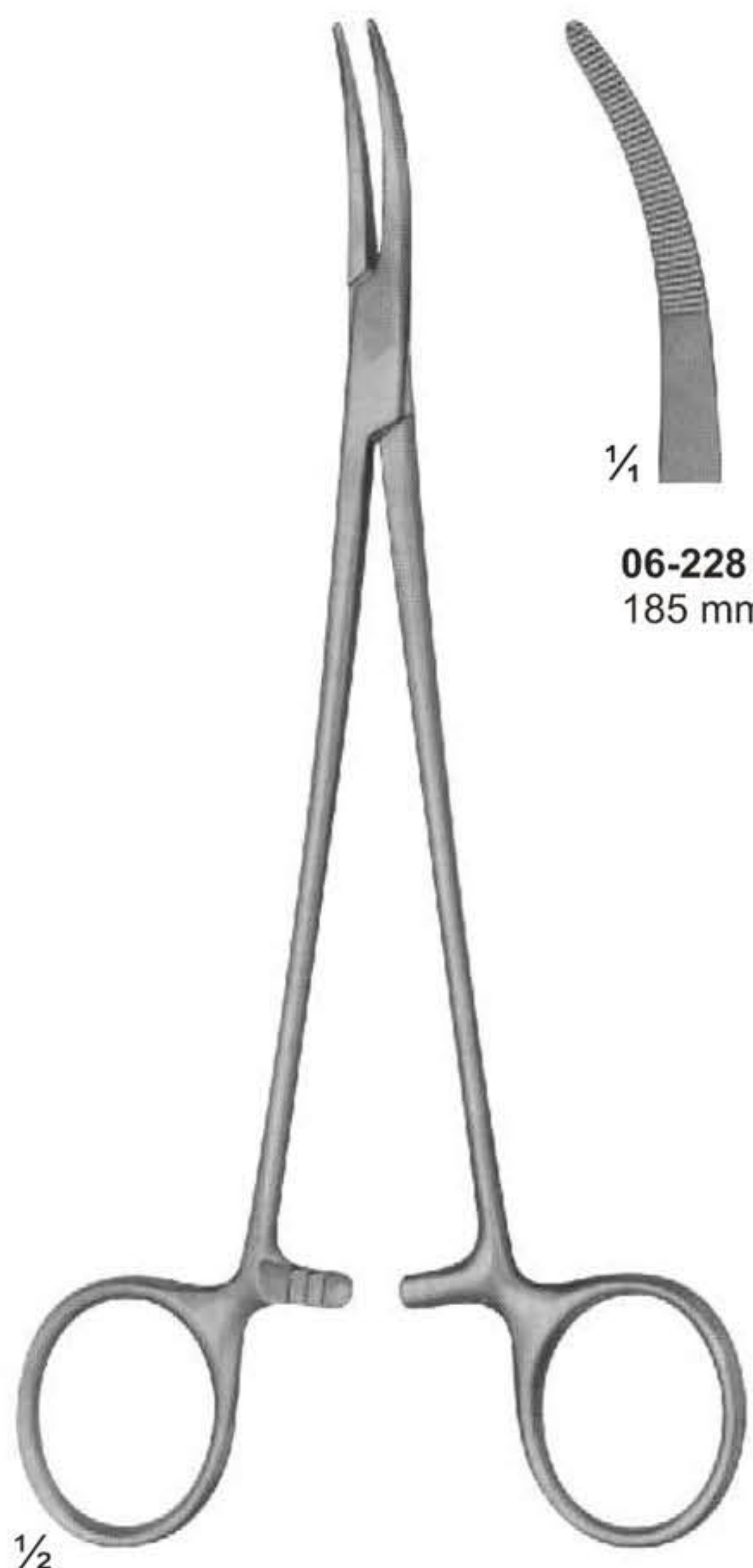

**06-228**  
NISSEN



**06-229 - 230**  
YASARGIL  
195 mm

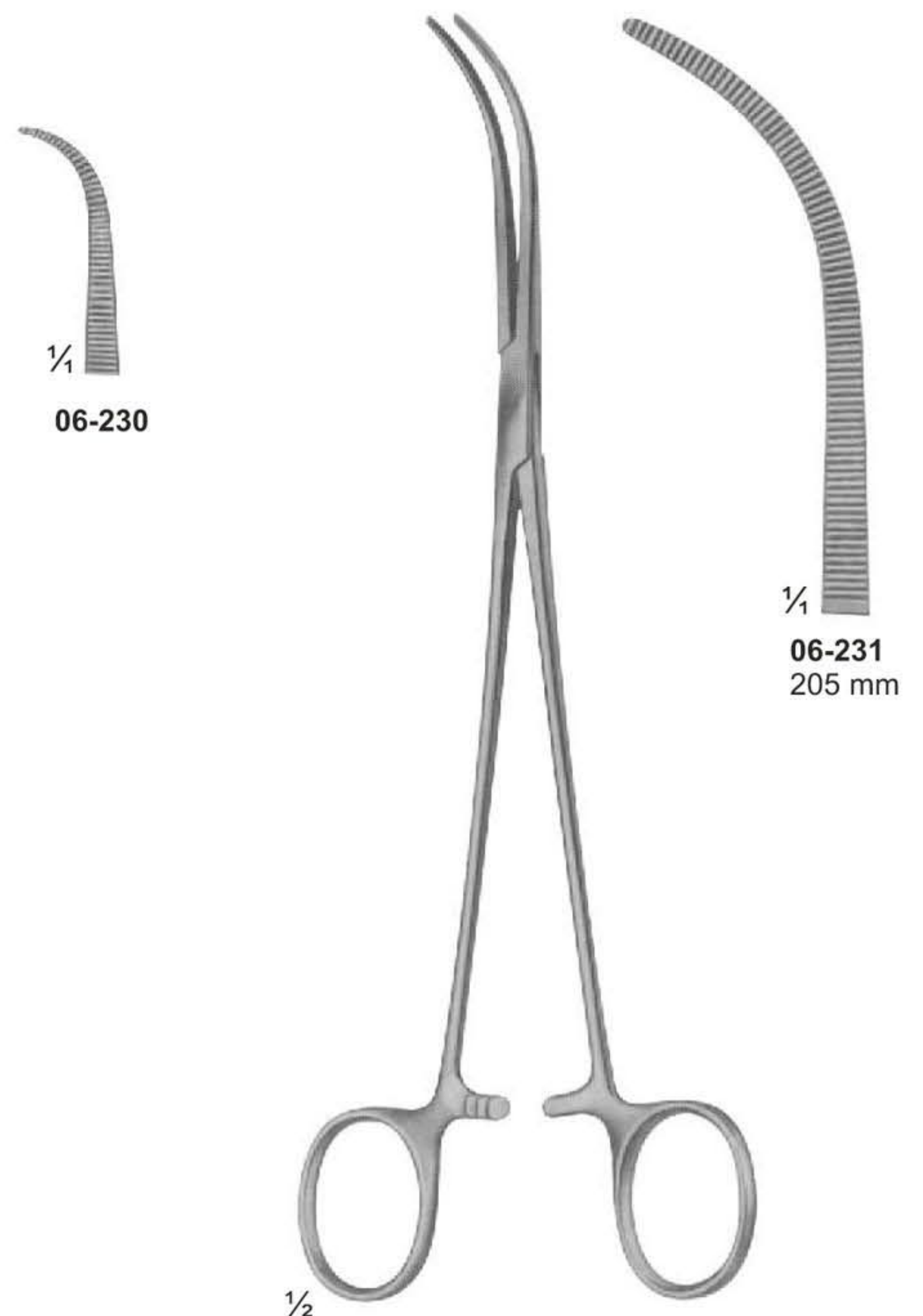

**06-231**  
OVERHOLT-MIXTER



# Dissecting- and Ligature Forceps



1/2

**06-232 - 243**  
OVERHOLT-GEISSENDOERFER

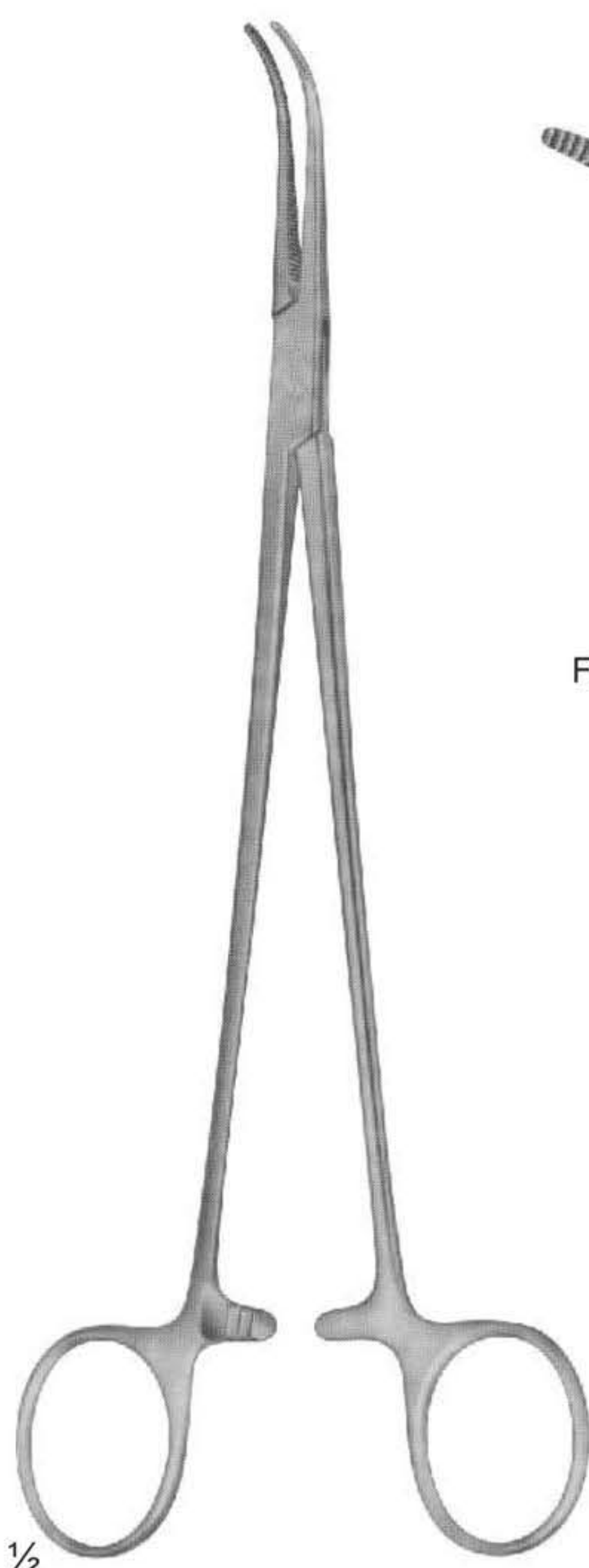
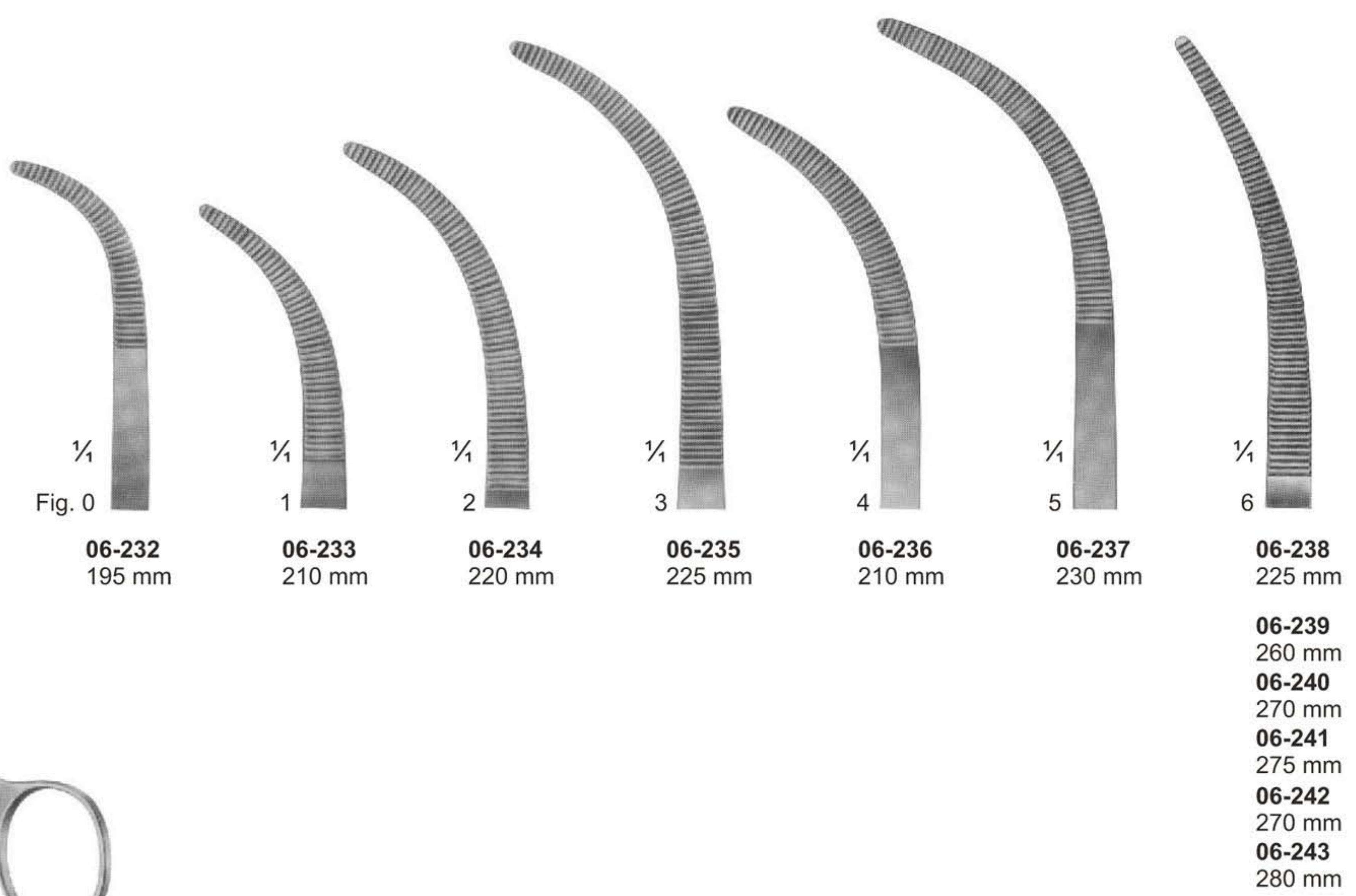

1/2

**06-244 - 251**  
OVERHOLT  
fine pattern

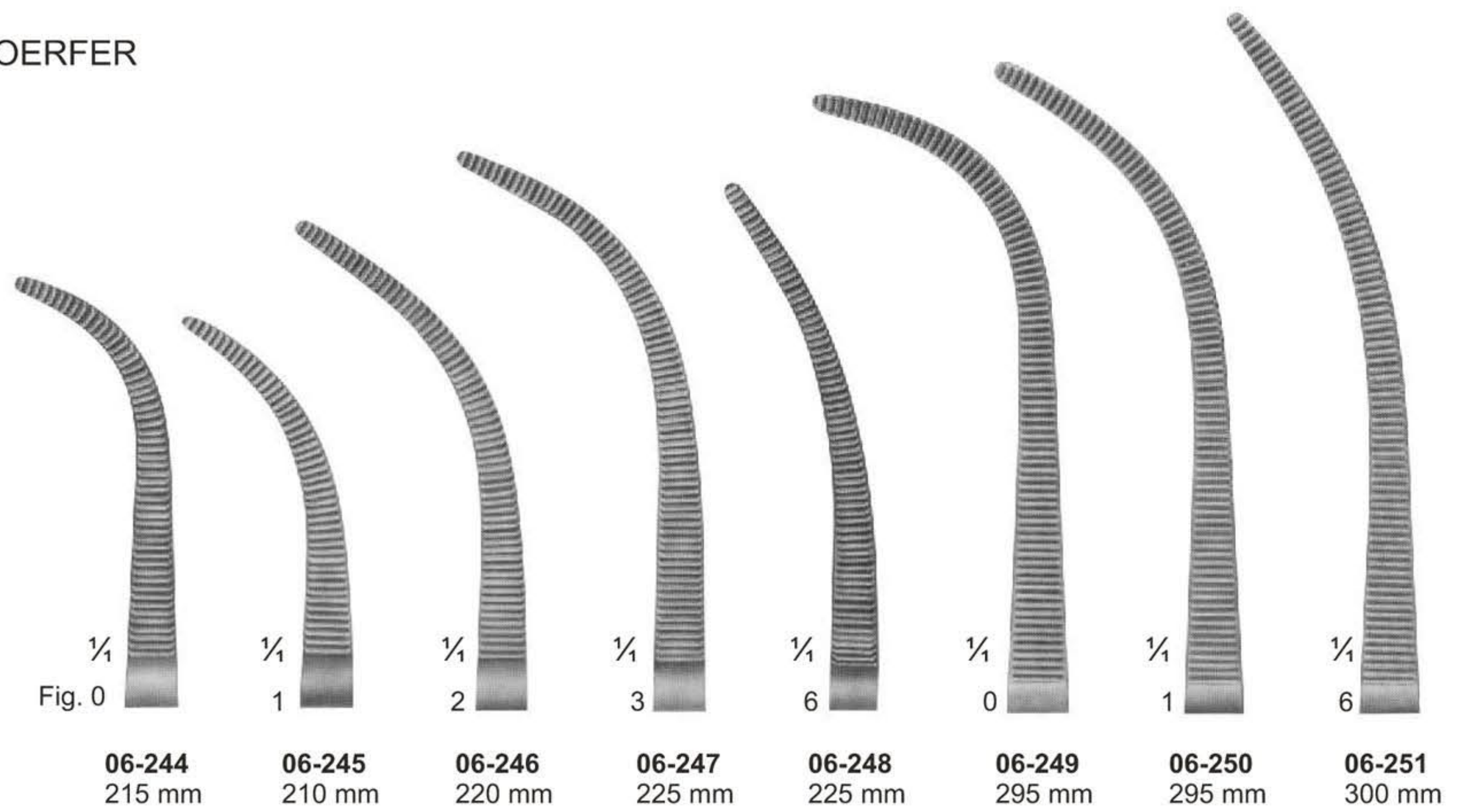



Dissecting- and Ligature Forceps

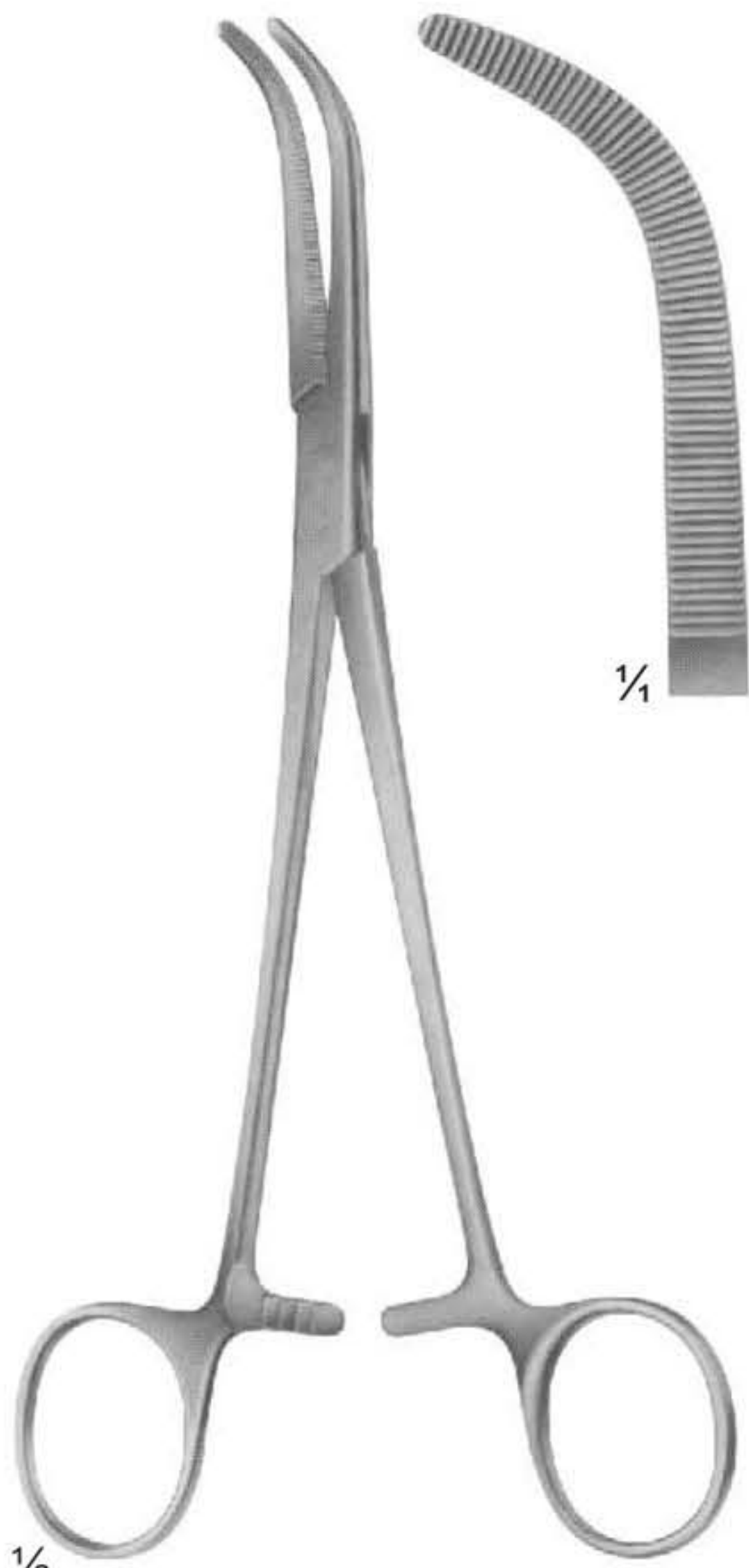

$\frac{1}{2}$   
**06-252**  
MIXTER-O'SHAUGNESSY  
190 mm

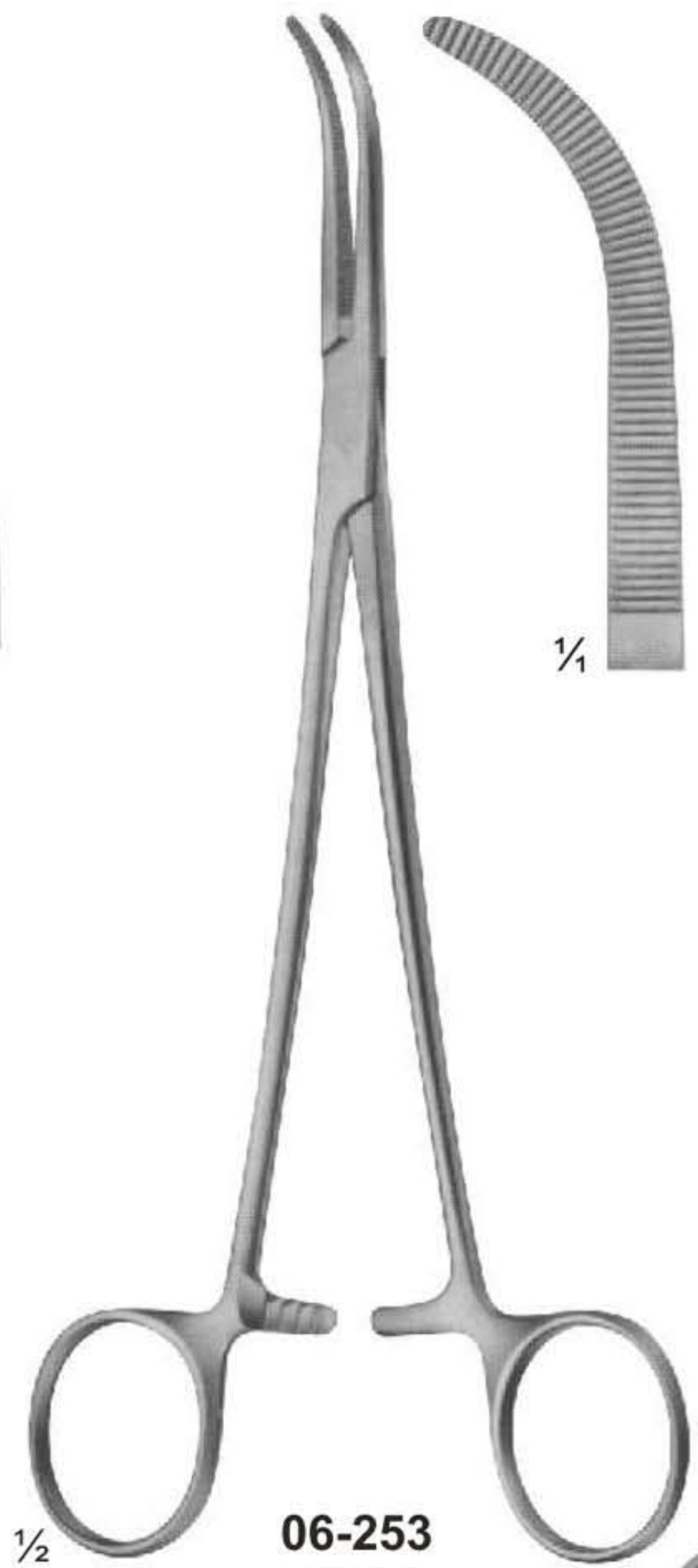

$\frac{1}{2}$   
**06-253**  
HEISS  
195 mm

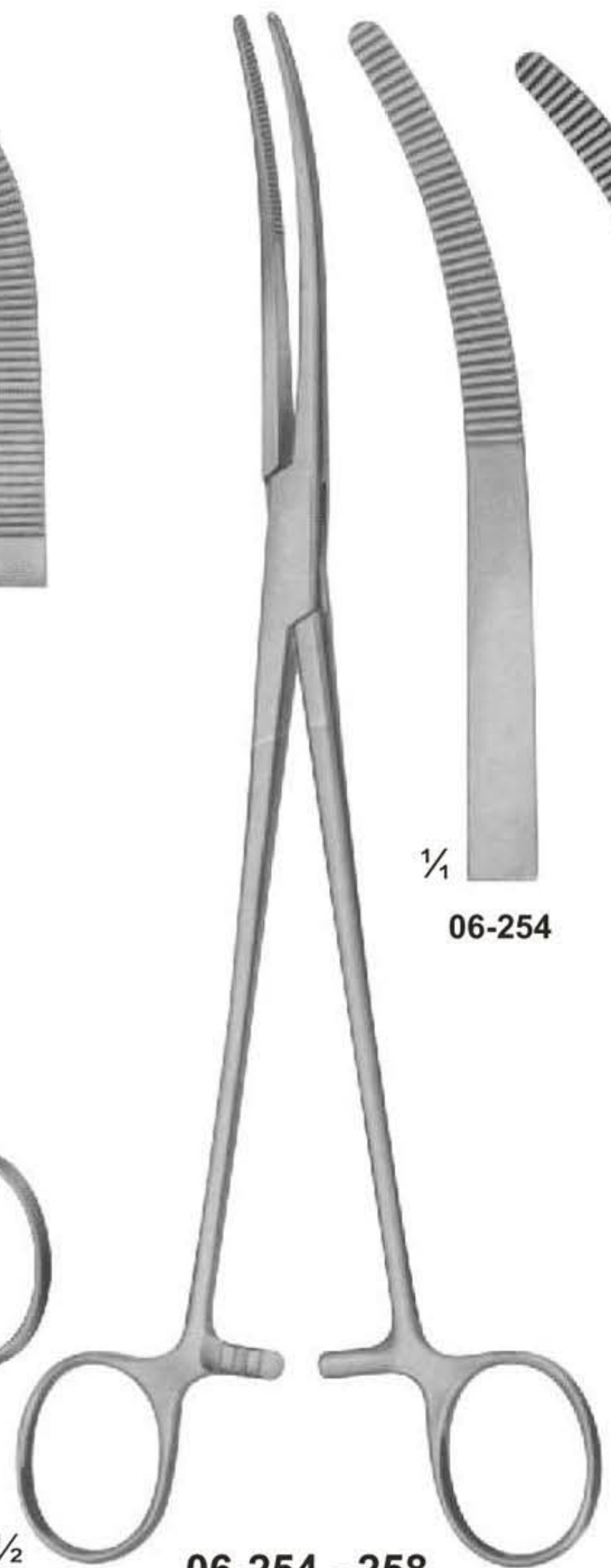

$\frac{1}{2}$   
**06-254 - 258**  
RUMEL  
240 mm

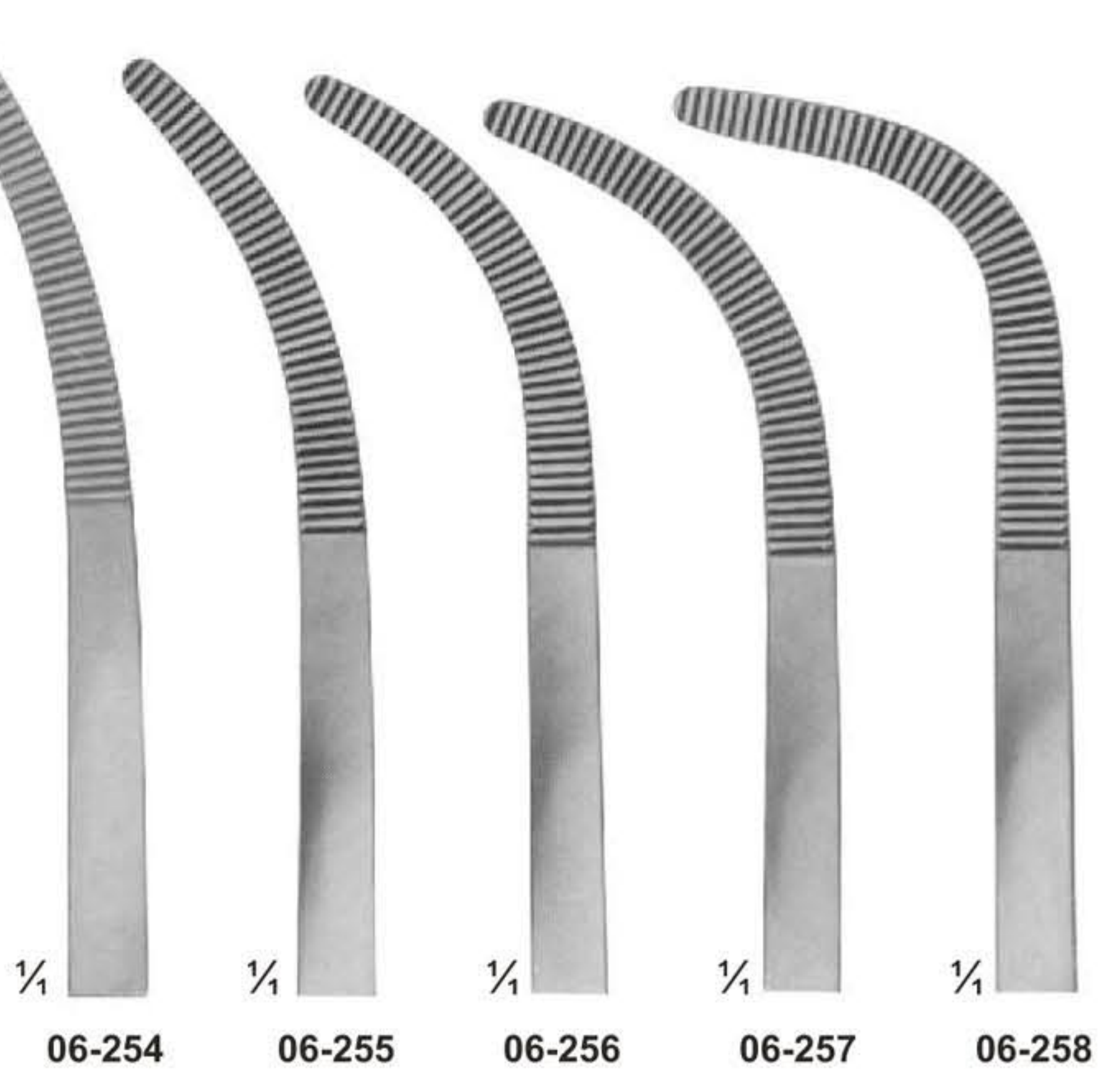

$\frac{1}{4}$  **06-254**    $\frac{1}{4}$  **06-255**    $\frac{1}{4}$  **06-256**    $\frac{1}{4}$  **06-257**    $\frac{1}{4}$  **06-258**

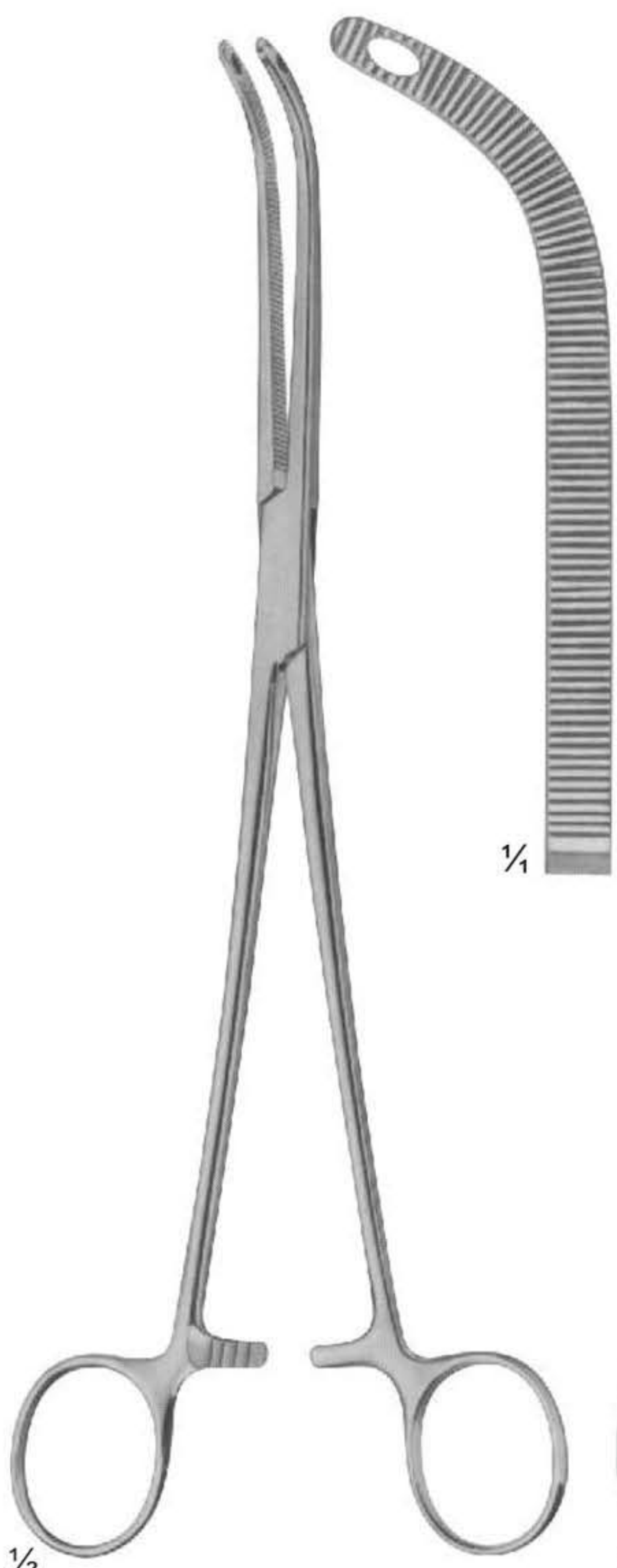

$\frac{1}{2}$   
**06-259**  
FINOCHIETTO  
245 mm

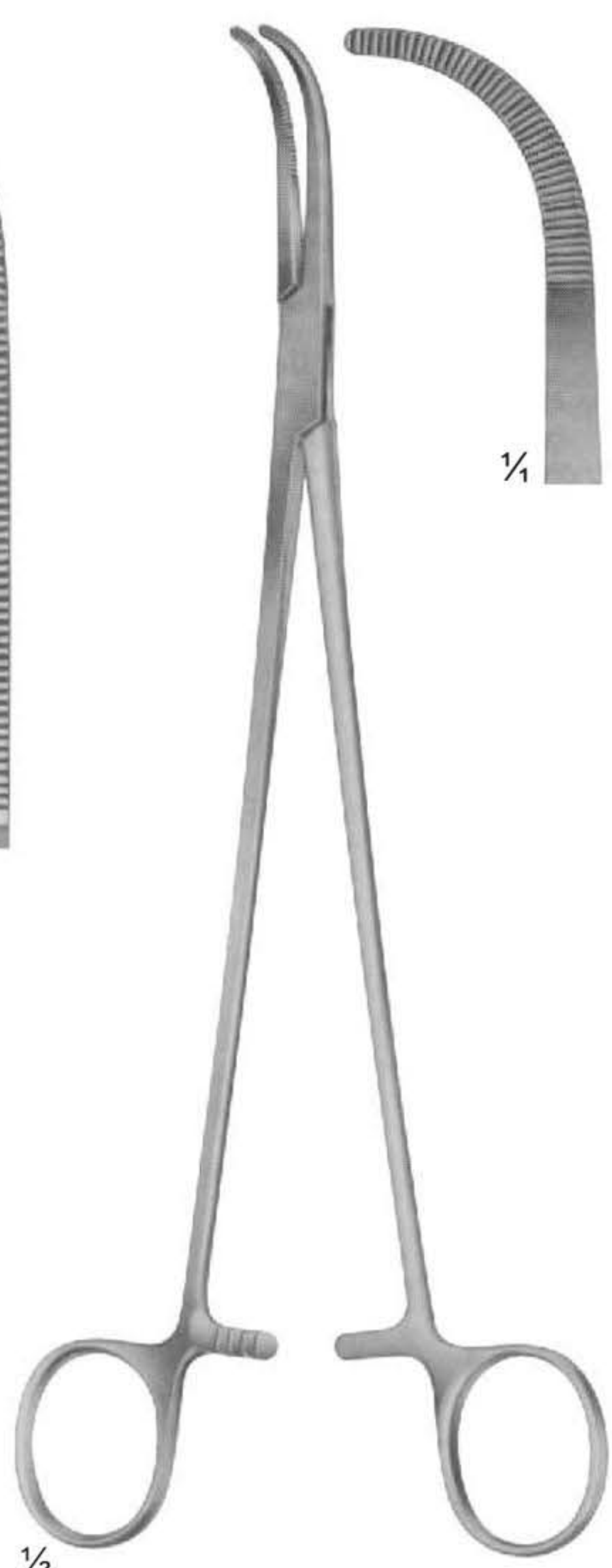

$\frac{1}{2}$   
**06-260**  
MIXTER  
230 mm



$\frac{1}{3}$   
**06-261**  
LAWRENCE  
270 mm

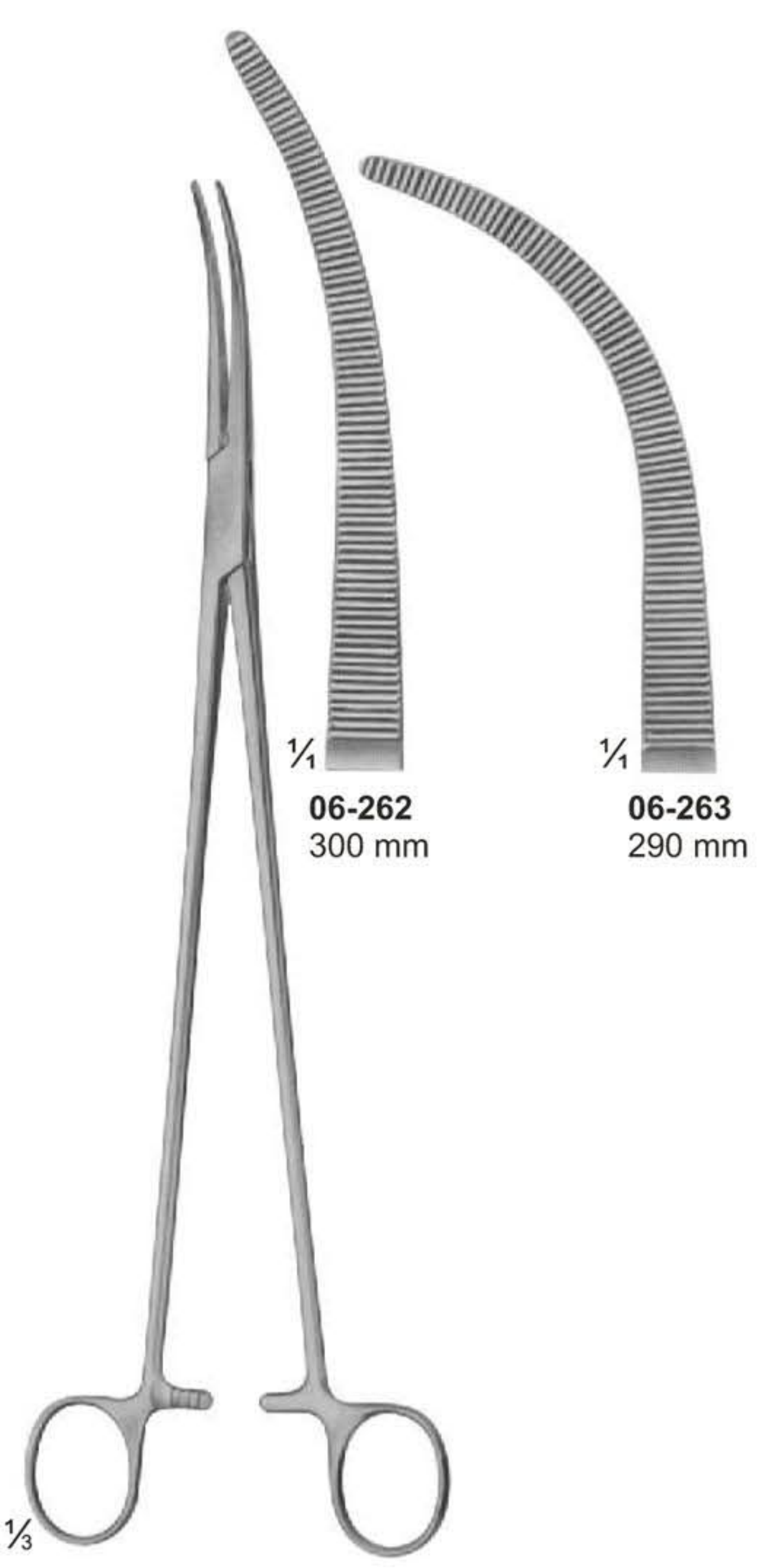

$\frac{1}{4}$  **06-262** 300 mm    $\frac{1}{4}$  **06-263** 290 mm

$\frac{1}{3}$   
**06-262 - 263**  
ZENKER



# Dissecting- and Ligature Forceps

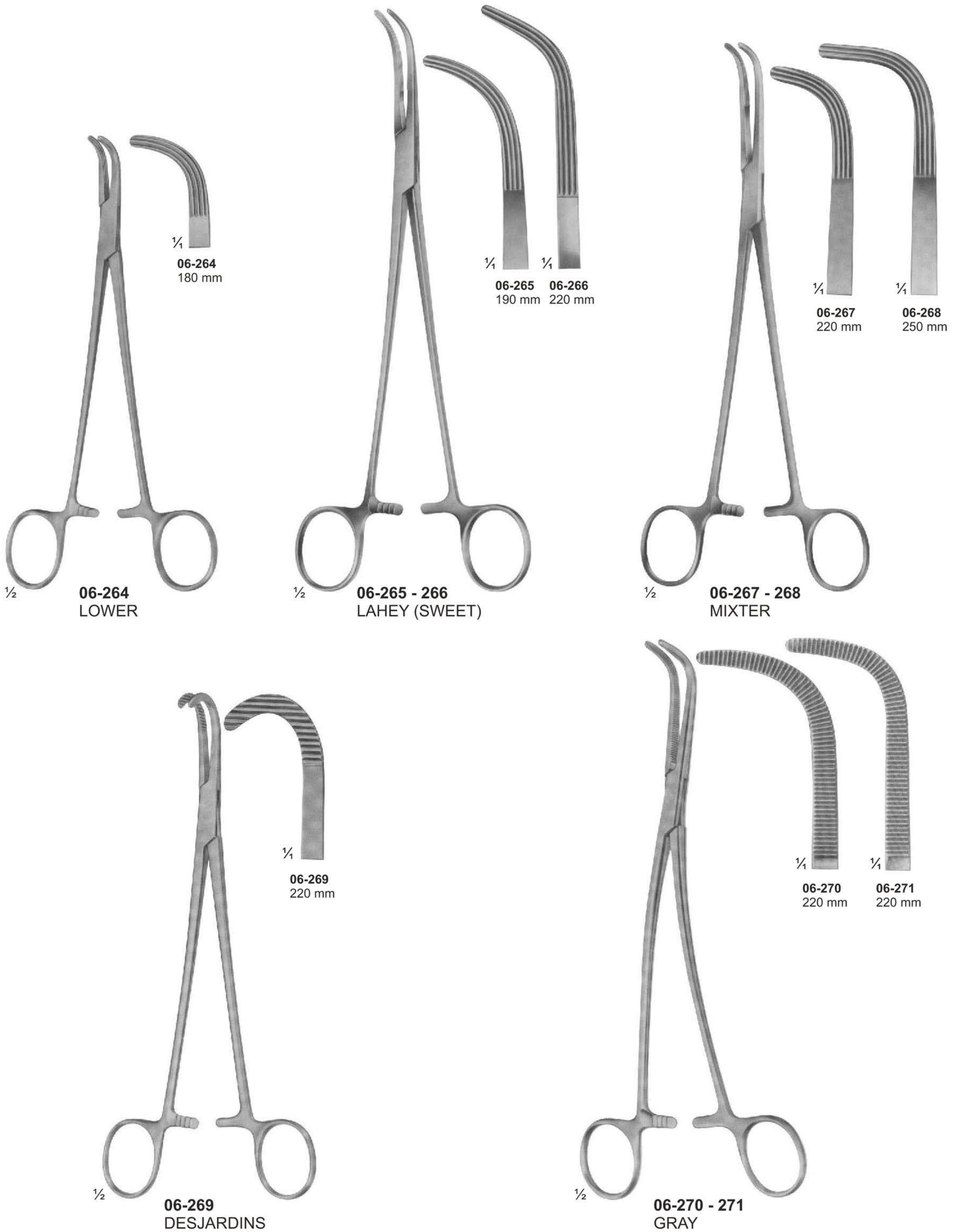



**Peritoneum Forceps**

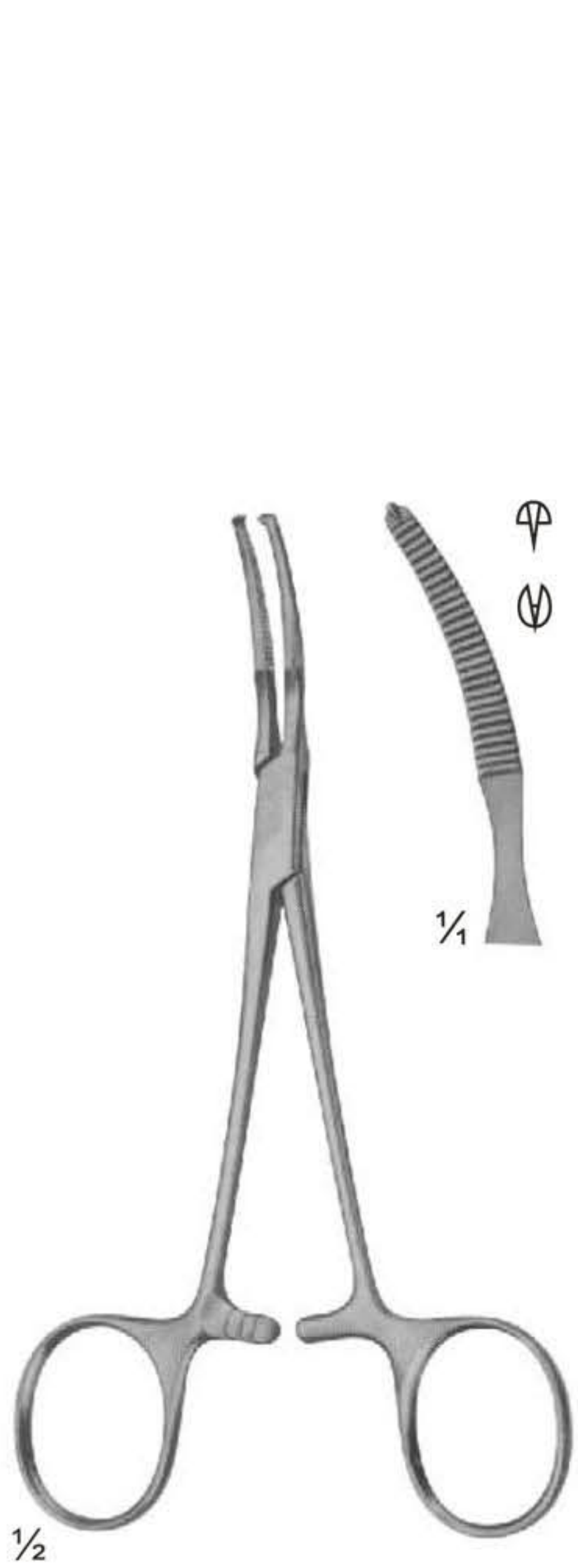

**06-272**  
BABY-MIKULICZ  
140 mm

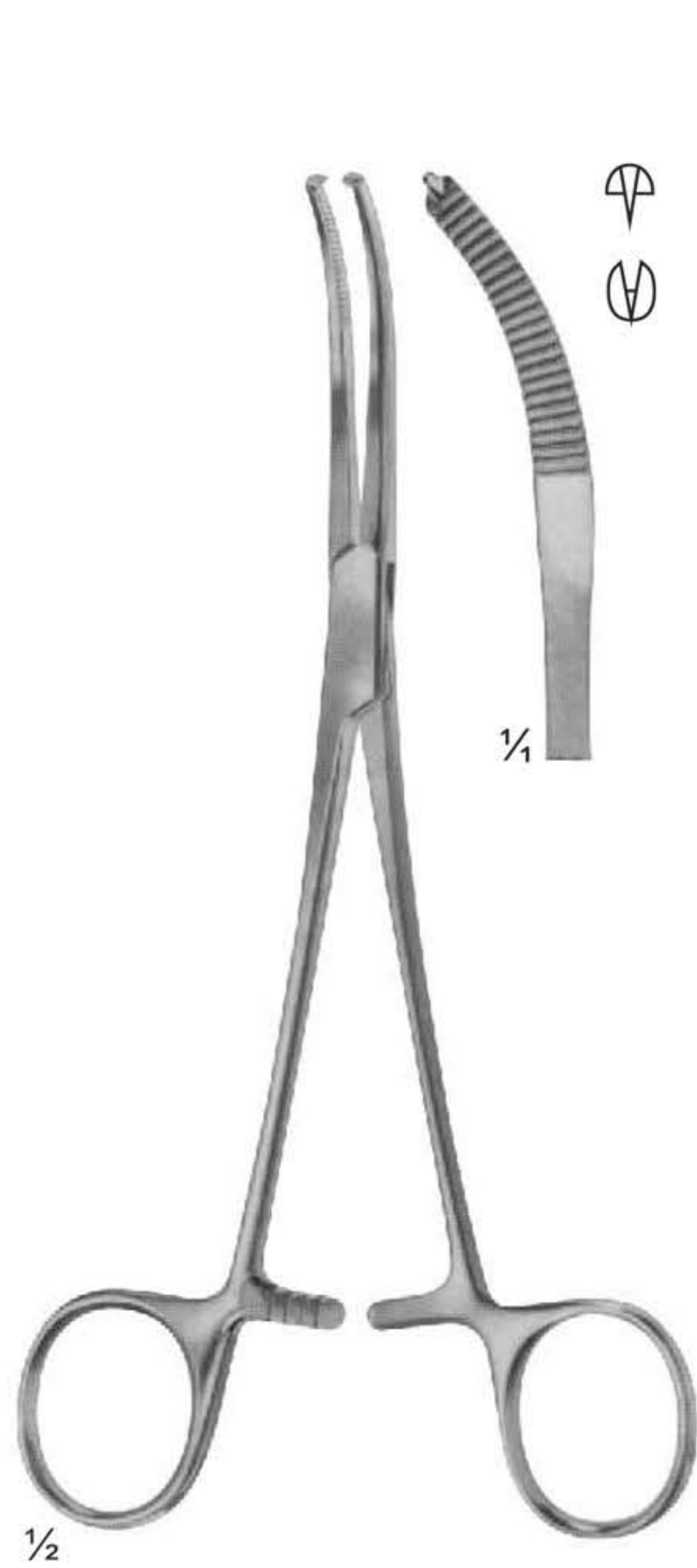

**06-273**  
MIKULICZ  
185 mm

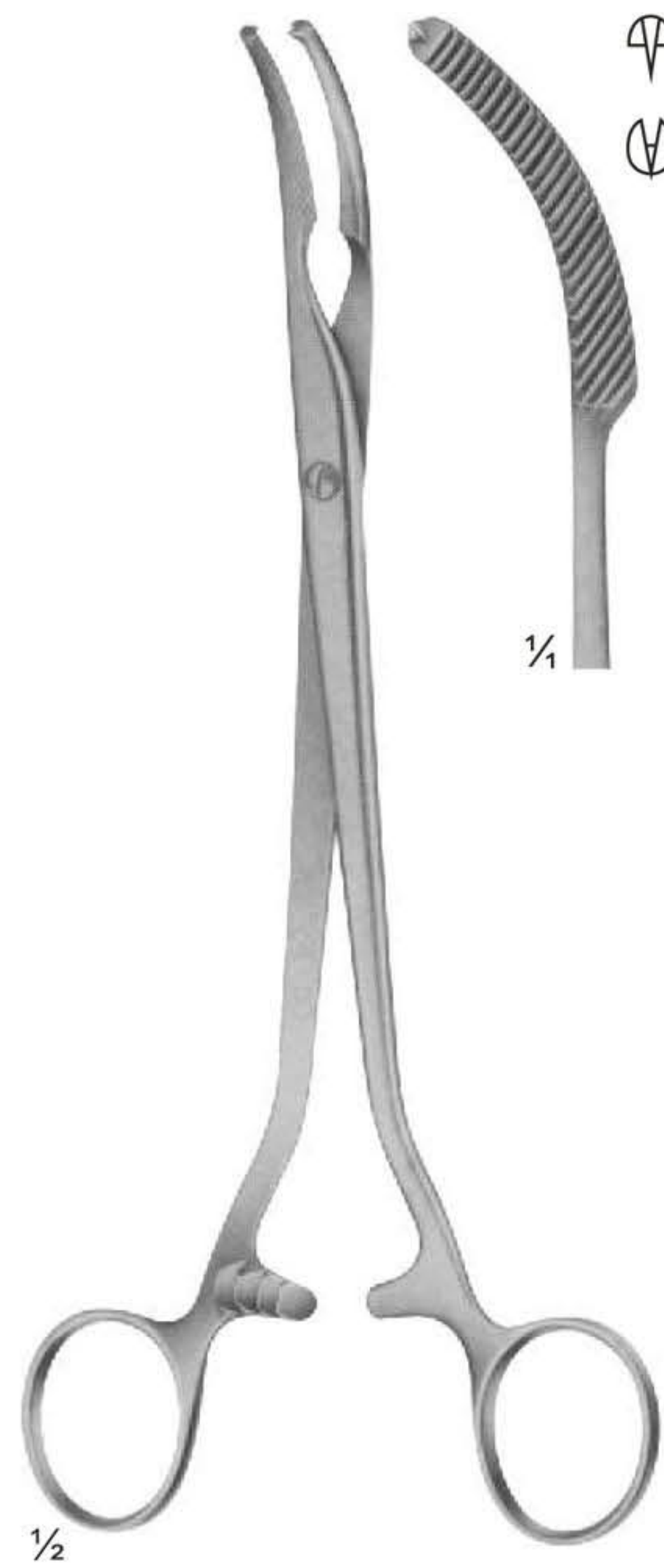

**06-274**  
MIKULICZ  
205 mm

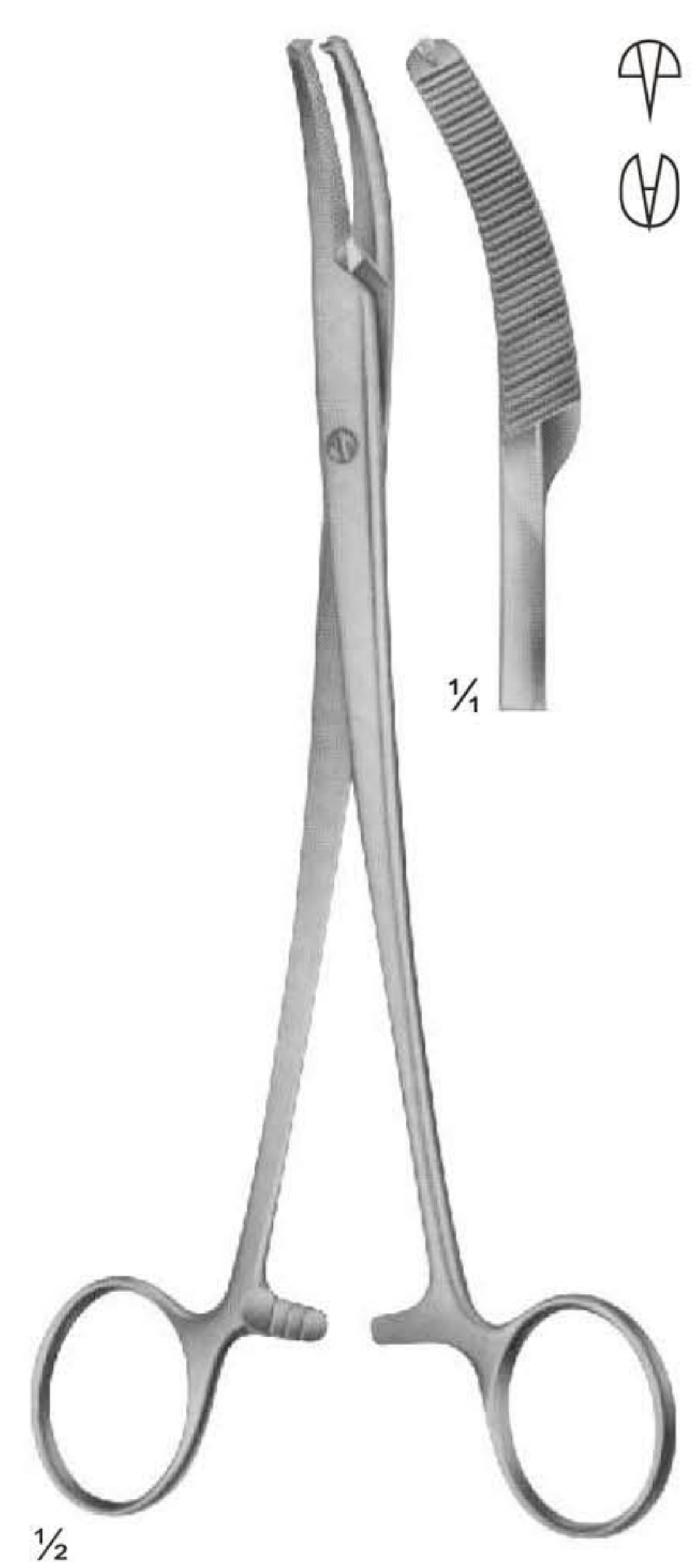

**06-275**  
MIKULICZ  
200 mm

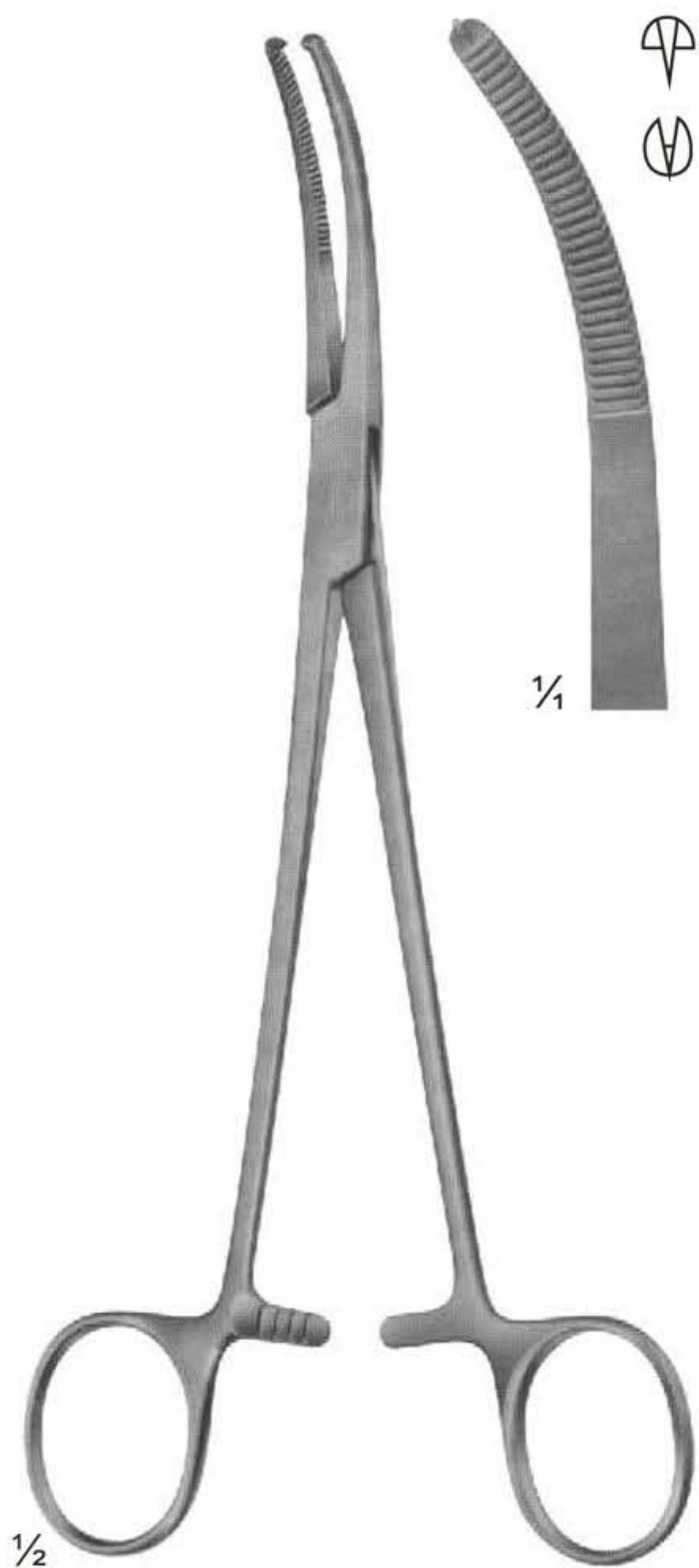

**06-276**  
MIKULICZ  
205 mm

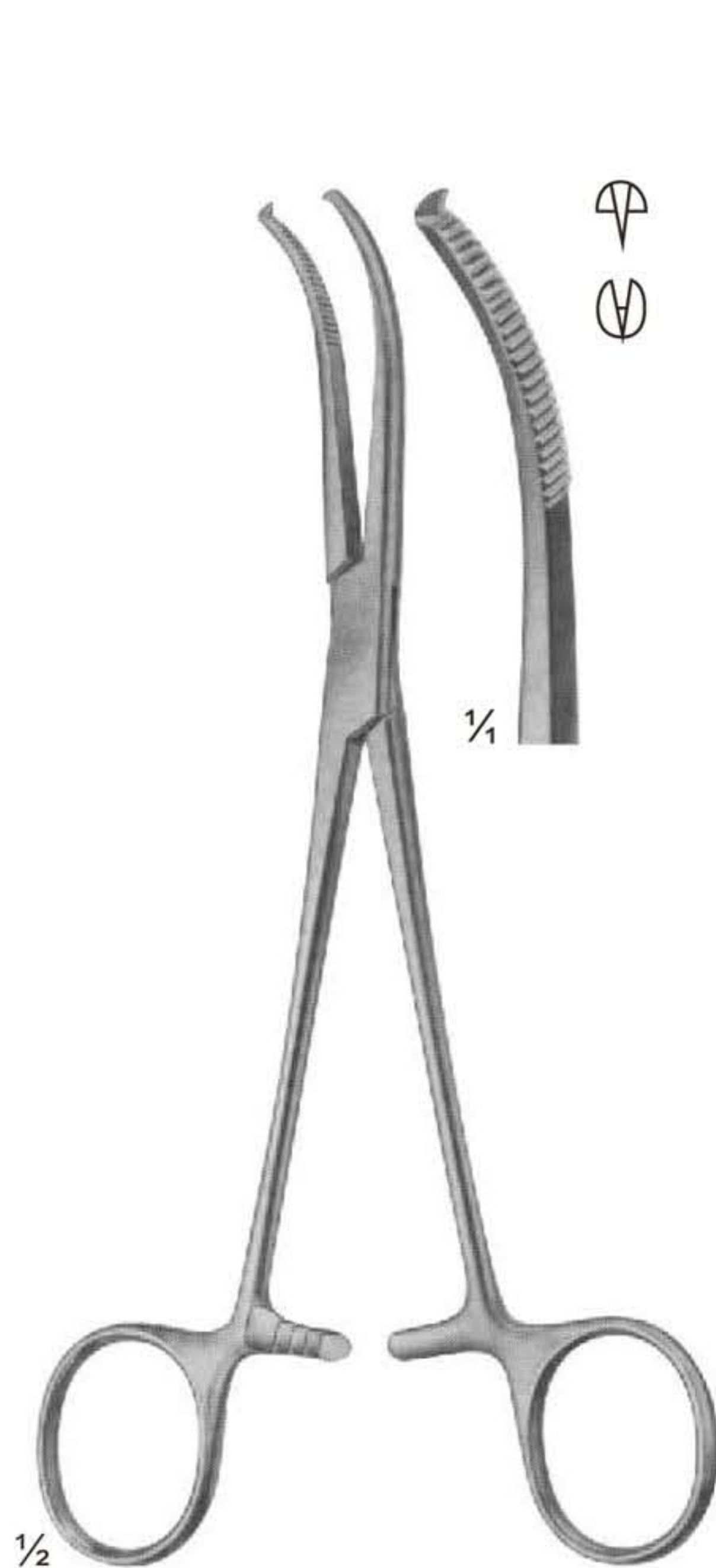

**06-277**  
MIKULICZ  
185 mm

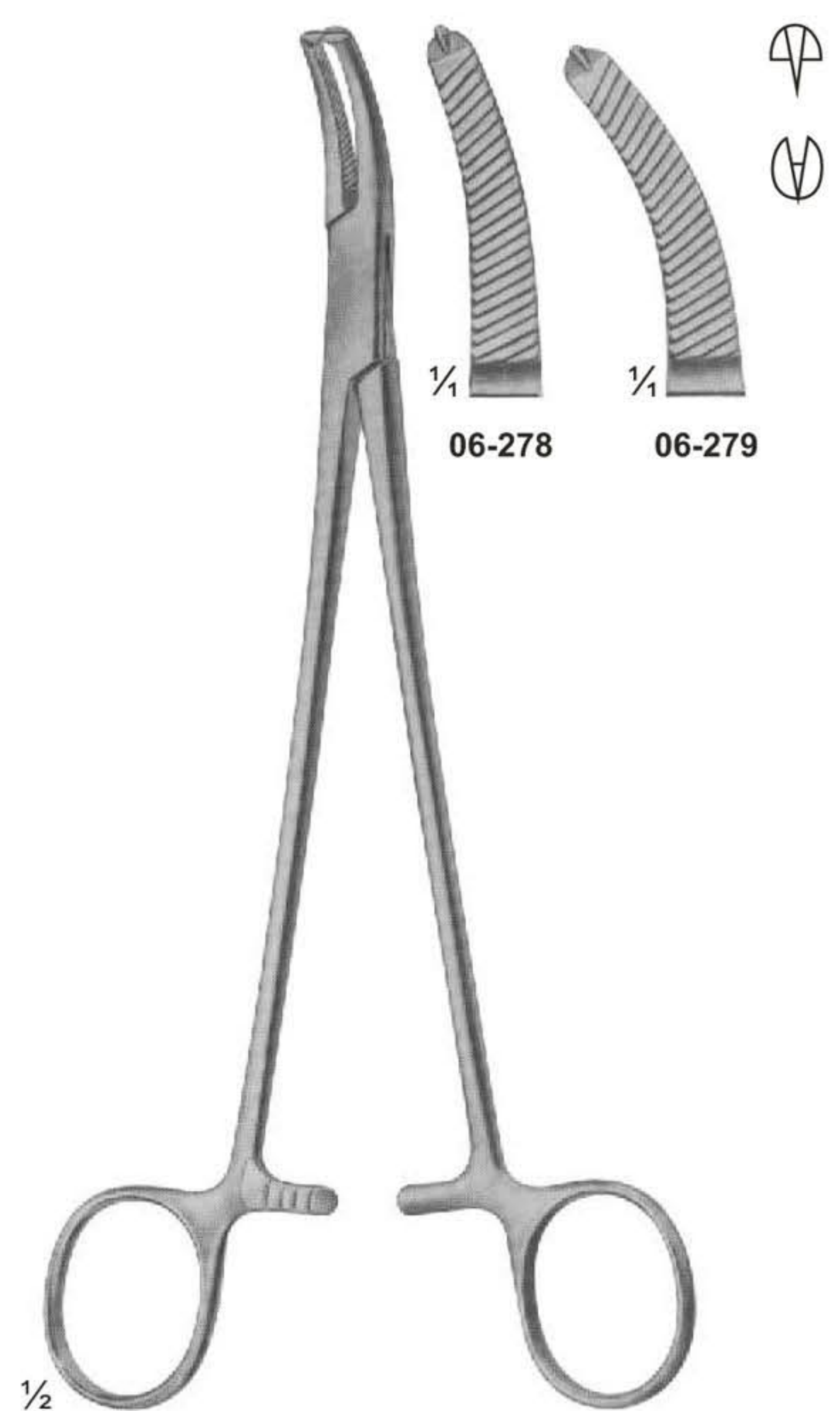

**06-278 - 279**  
FAURE  
205 mm



# Hysterectomy Forceps

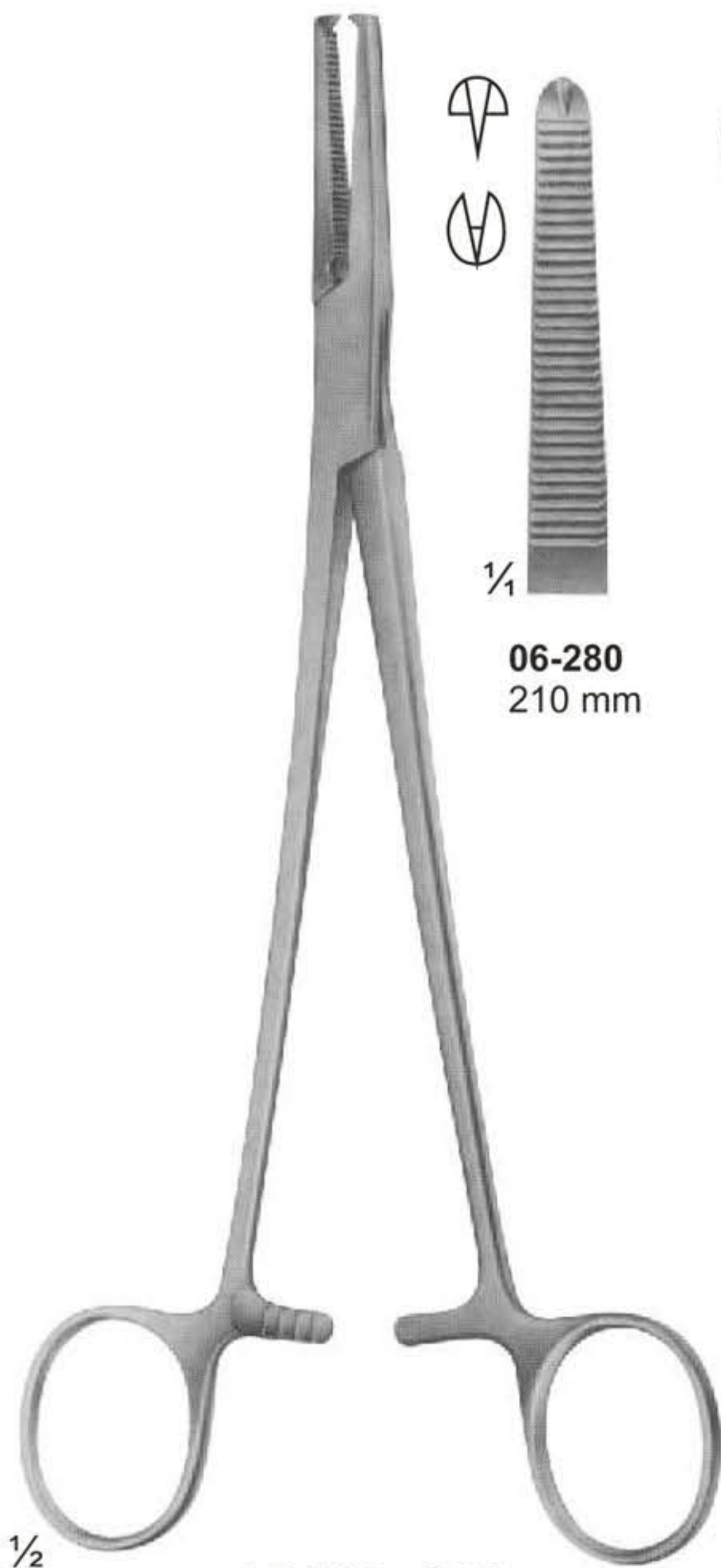

**06-280 - 281**  
PHANEUF

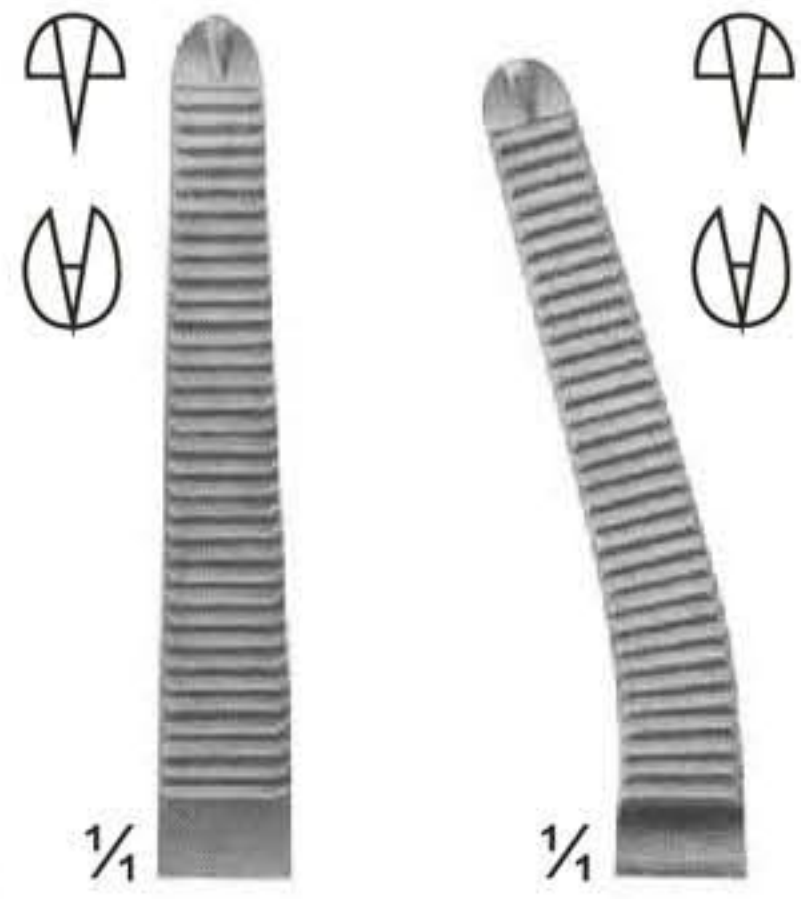

**06-280**  
210 mm

**06-281**  
205 mm



**06-282 - 283**  
HEANEY modif.

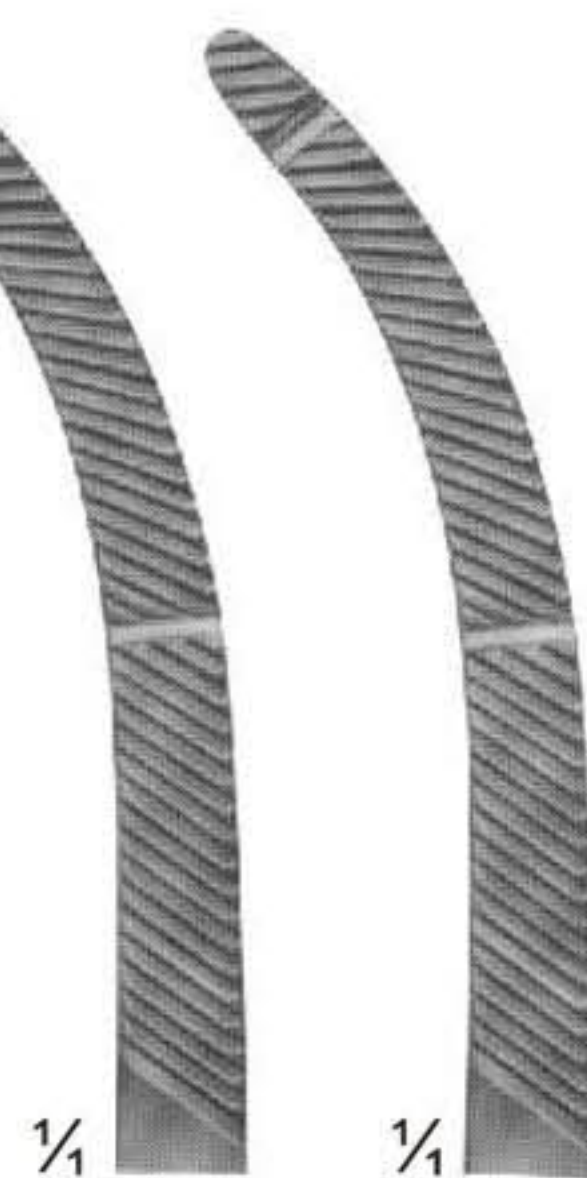

**06-282**  
205 mm

**06-283**  
245 mm

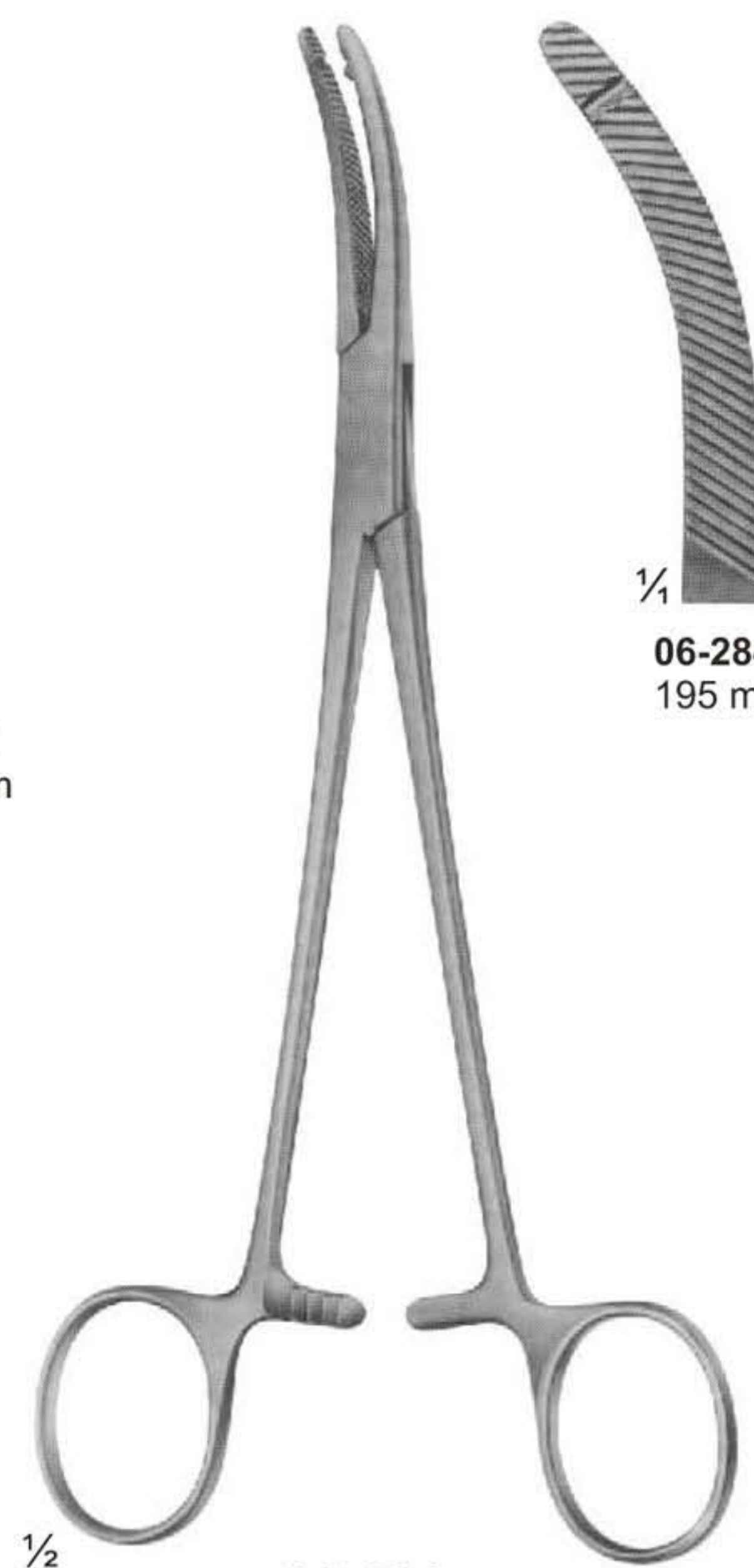

**06-284**  
HEANEY



**06-284**  
195 mm

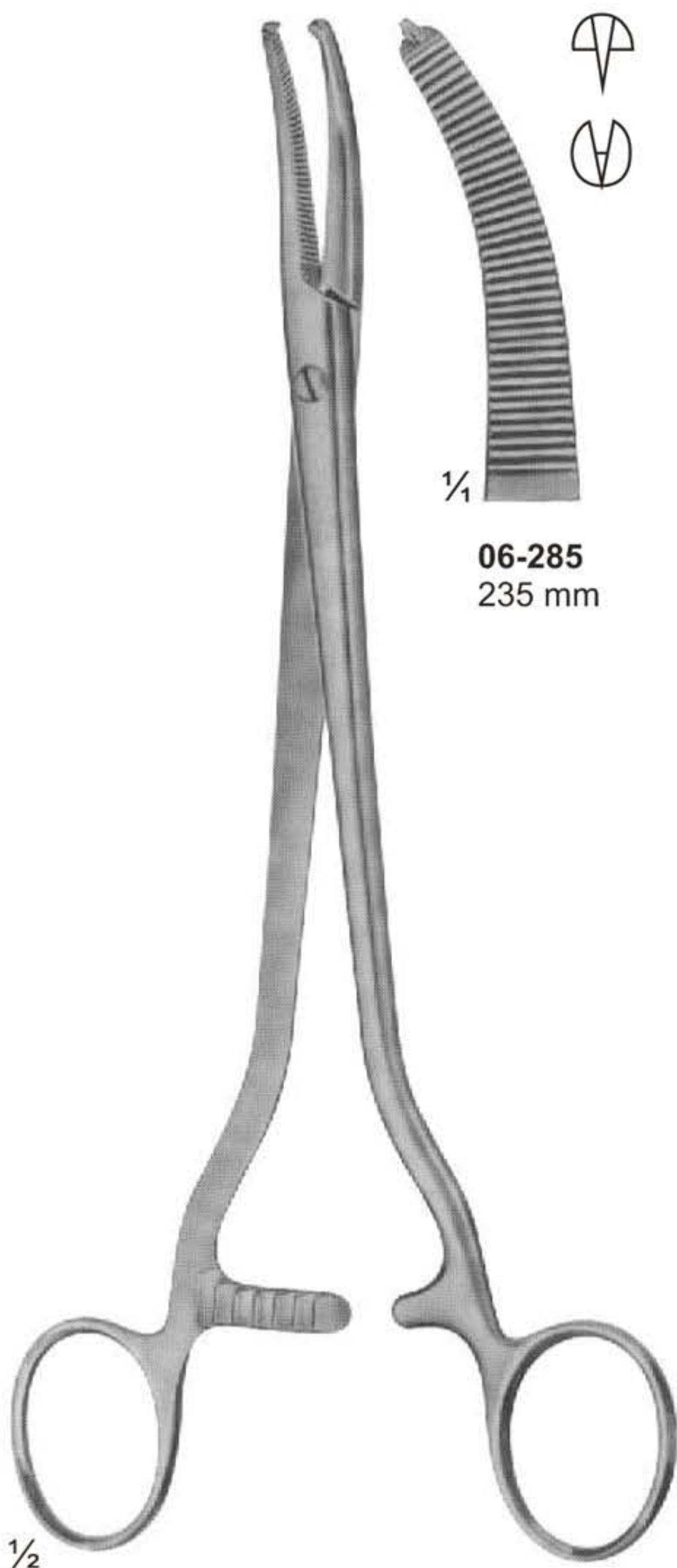

**06-285**  
WERTHEIM



**06-285**  
235 mm

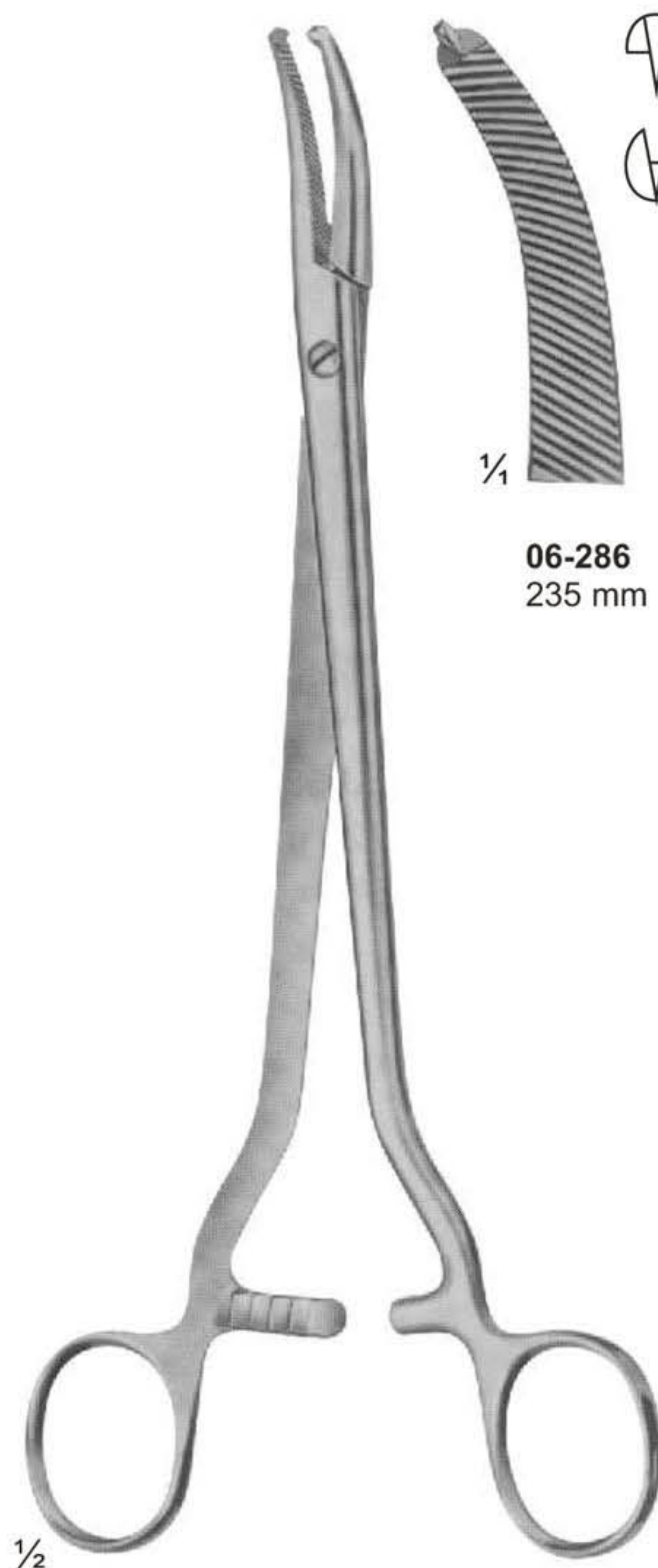

**06-286**  
WERTHEIM



**06-286**  
235 mm

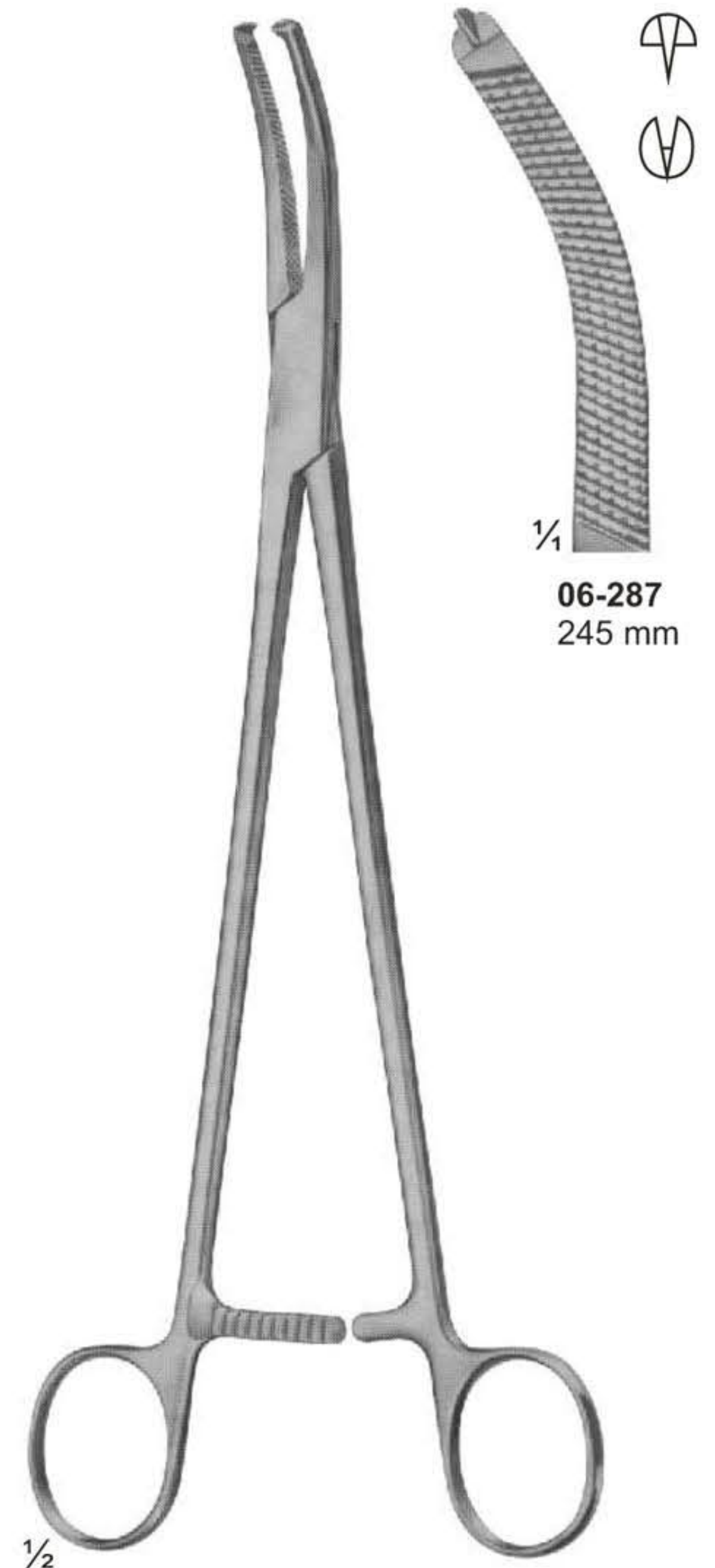

**06-287**  
WERTHEIM

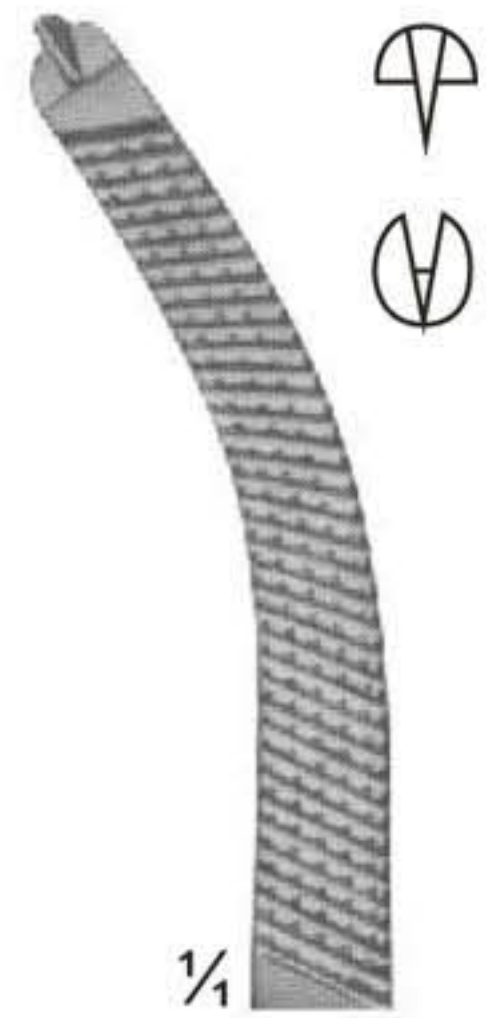

**06-287**  
245 mm



## Hysterectomy Forceps and Vaginal Clamps



1/2



06-288  
225 mm



06-289  
220 mm



06-290  
215 mm



06-291  
205 mm



1/2



06-292  
250 mm



06-293  
245 mm



06-294  
240 mm

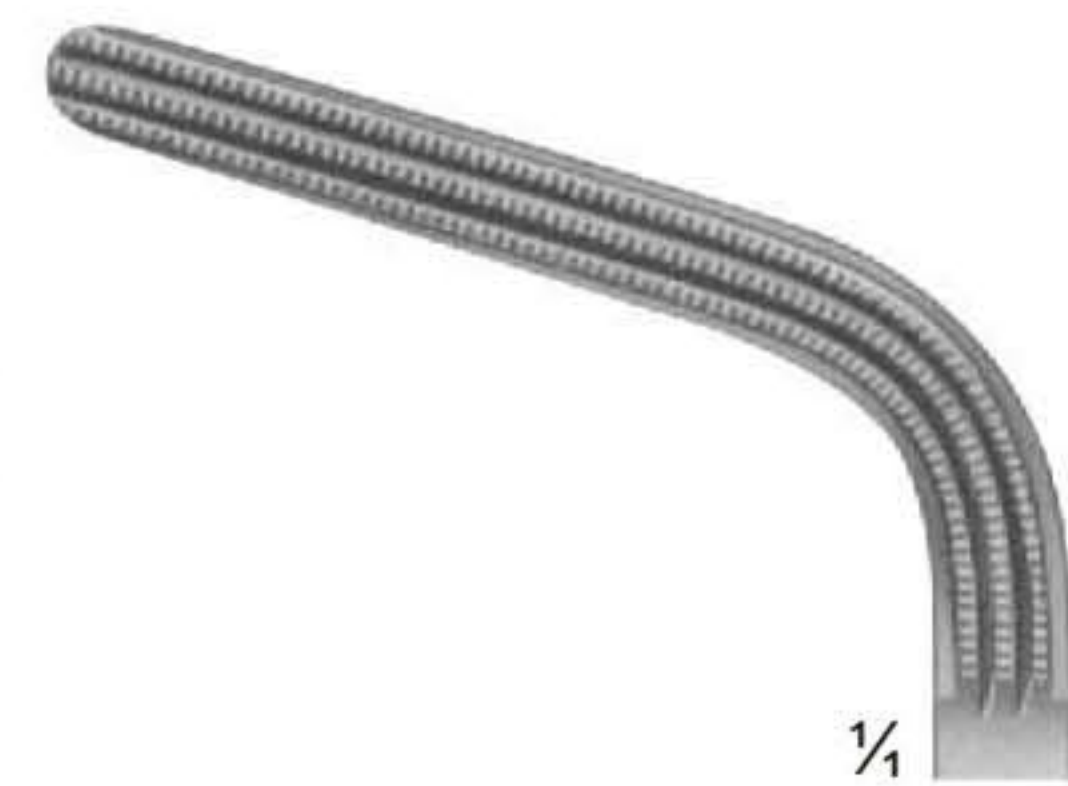

06-295  
220 mm



# Hysterectomy Forceps and Vaginal Clamps and Compression Forceps

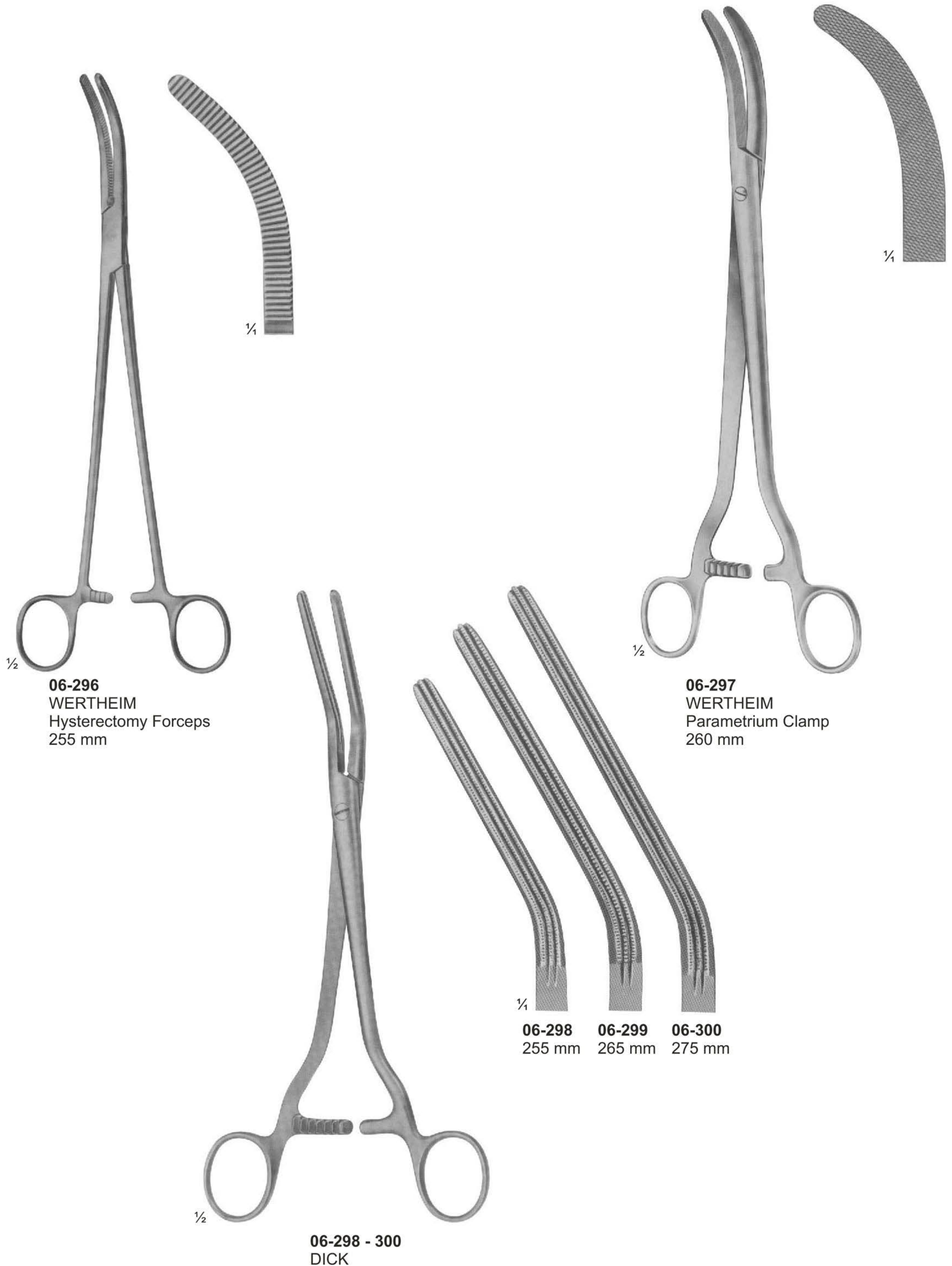



# Hysterectomy Forceps and Vaginal Clamps and Compression Forceps

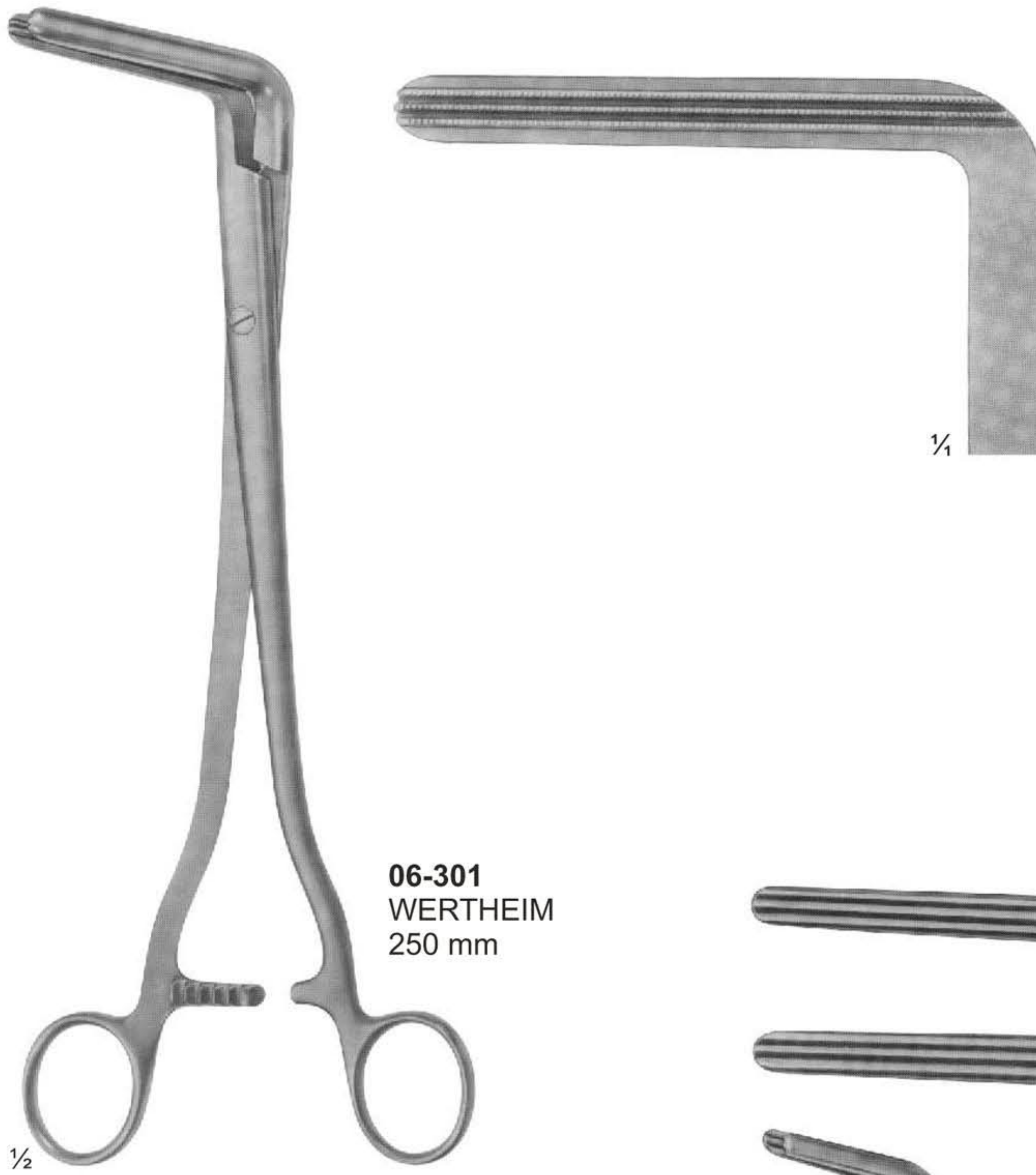

**06-301**  
WERTHEIM  
250 mm

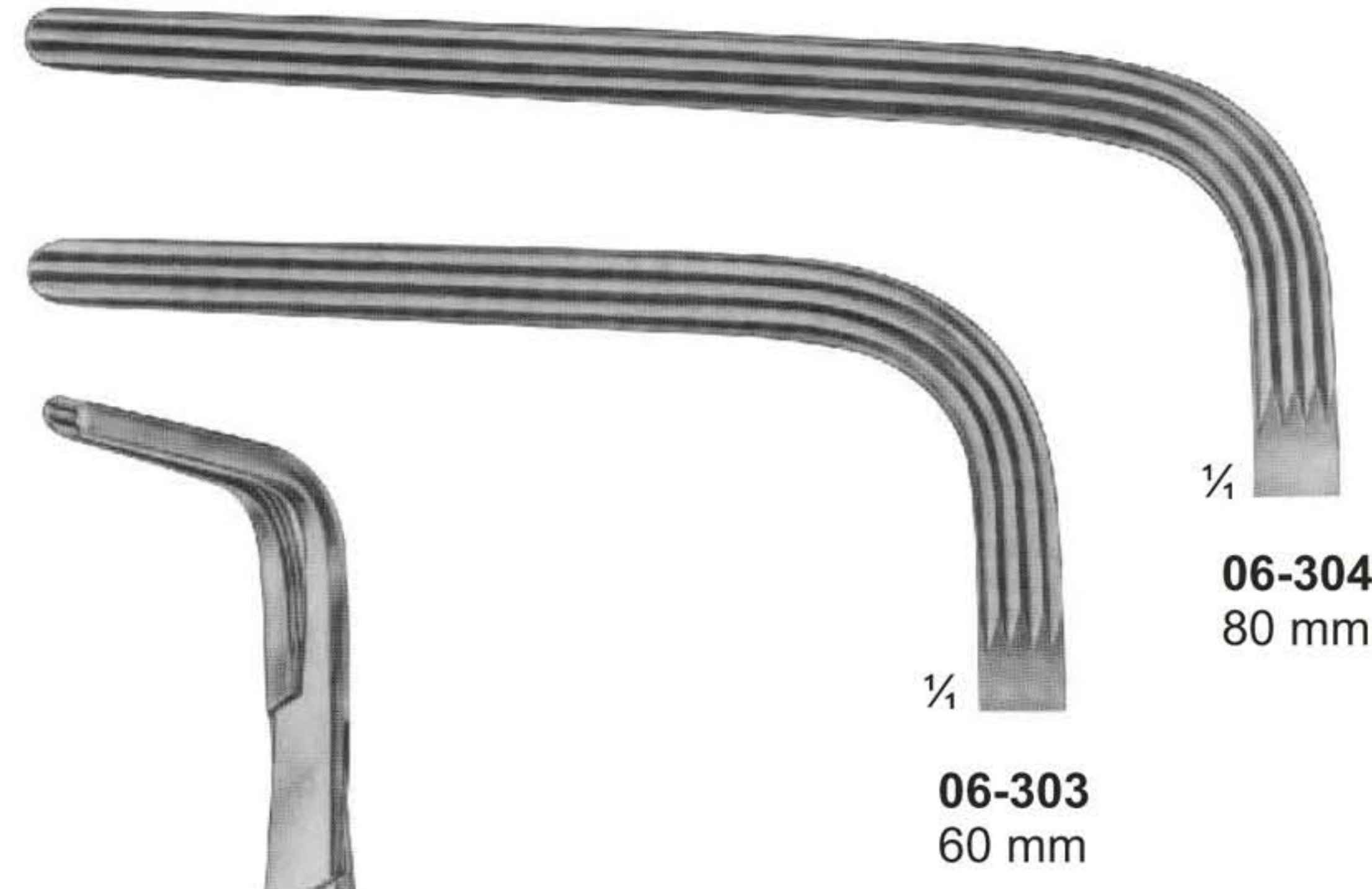

**06-303**  
60 mm

**06-304**  
80 mm



**06-302**  
WERTHEIM-CULLEN  
215 mm



**06-303 - 304**  
230 mm



## Needle Holders For Micro Surgery



**07-101**  
**ROHRSCHEIDER**  
With copper inserts  
100 mm



**07-102**  
**KALT**  
With catch  
135 mm

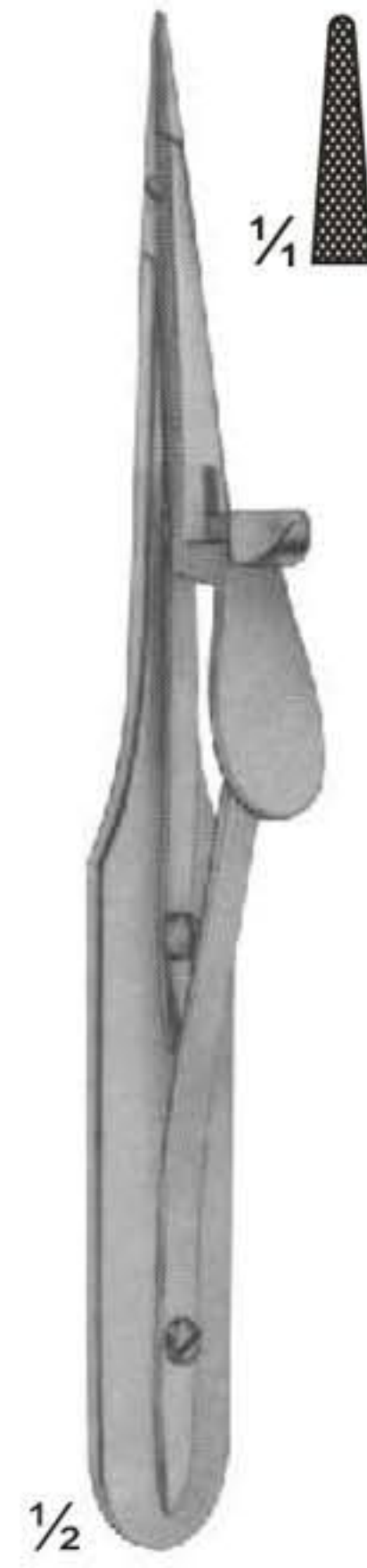

**07-103**  
**ARRUGA**  
With catch  
135 mm



**07-104 - 105**  
**CASTROVIEJO**  
With catch  
145 mm



**07-106 - 107**  
**CASTROVIEJO**  
With Catch  
160 mm

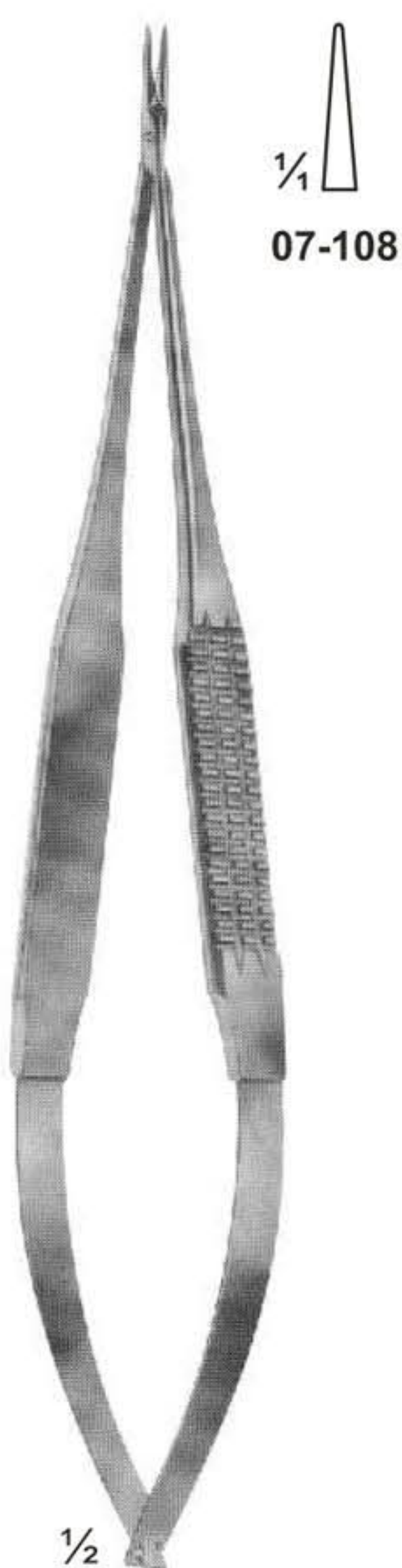

**07-108 - 109**  
Without catch  
185 mm

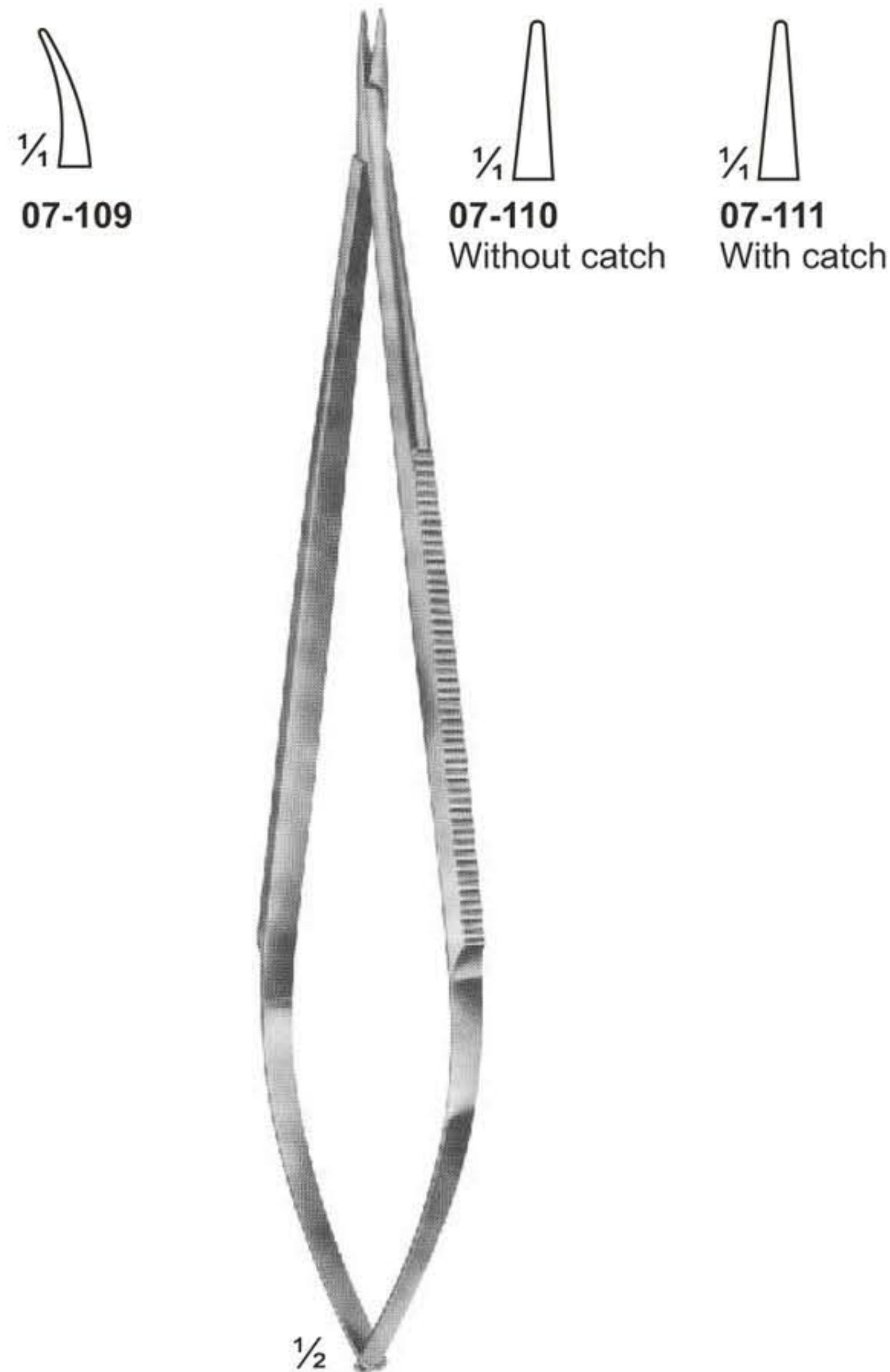

**07-110 - 111**  
**JACOBSON**  
185 mm



**07-112**  
Without catch  
195 mm

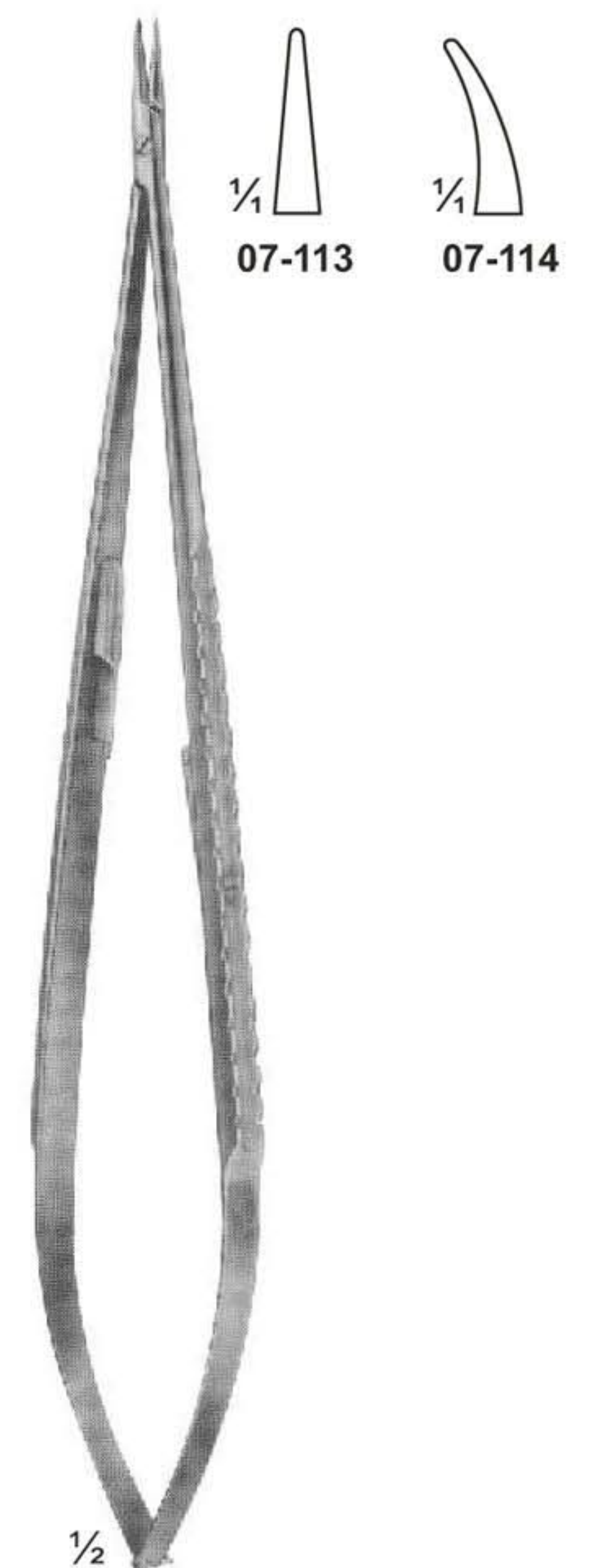

**07-113 - 114**  
**YASARGIL**  
With catch  
200 mm



## Micro Needle Holders With Round Handles



$\frac{1}{4}$ "  $\frac{1}{4}$ "  
**07-115** **07-116**  
115 mm 135 mm

$\frac{1}{2}$   
**07-115 116**  
BARRAQUER  
Without catch



$\frac{1}{4}$ "  $\frac{1}{4}$ "  
**07-117** **07-118**

$\frac{1}{2}$   
**07-117 - 118**  
BARRAQUER  
Without catch  
120 mm



$\frac{1}{4}$ "  $\frac{1}{4}$ "  
**07-119** **07-120**

$\frac{1}{2}$   
**07-119 - 120**  
BARRAQUER  
With catch  
120 mm



$\frac{1}{4}$ "  $\frac{1}{4}$ "  
**07-121** **07-122**

$\frac{1}{2}$   
**07-121 - 122**  
BARRAQUER  
With Catch  
150 mm



$\frac{1}{4}$ "

$\frac{1}{2}$   
**07-123**  
MULLER  
With Locking  
Mechanism  
145 mm



$\frac{1}{4}$ "  $\frac{1}{4}$ "  
**07-126** **07-127**

$\frac{1}{2}$   
**07-126 - 127**  
YASARGIL  
200 mm



$\frac{1}{4}$ "  $\frac{1}{4}$ "  
**07-128** **07-129**

$\frac{1}{2}$   
**07-128 - 129**  
YASARGIL  
225 mm



$\frac{1}{4}$ "  $\frac{1}{4}$ "  
**07-124** **07-125**

$\frac{1}{2}$   
**07-124 - 125**  
BROCK  
Without catch  
150 mm



$\frac{1}{4}$ "

$\frac{1}{2}$   
**07-130**  
YASARGIL  
245 mm



# Needle Holders

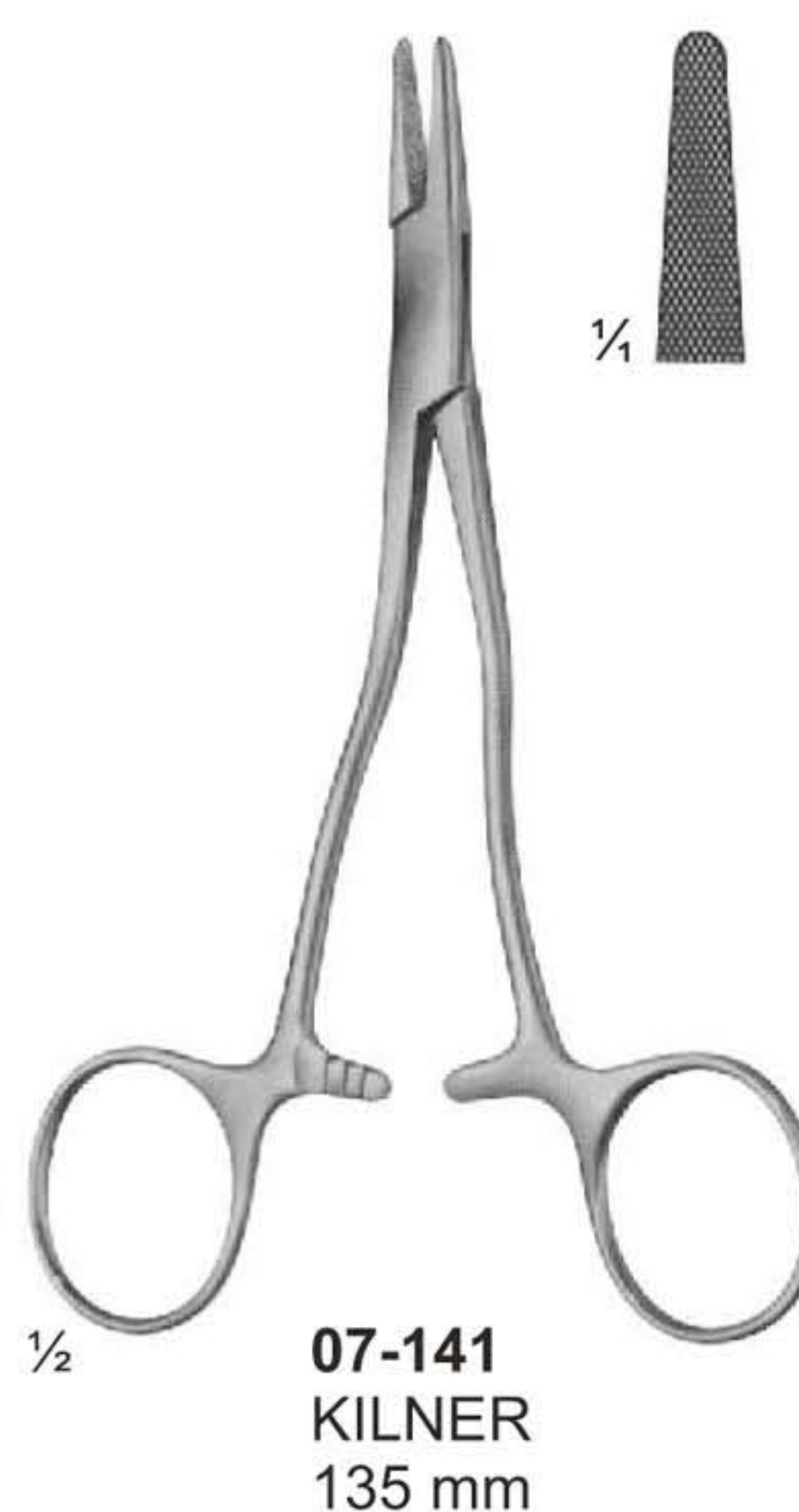
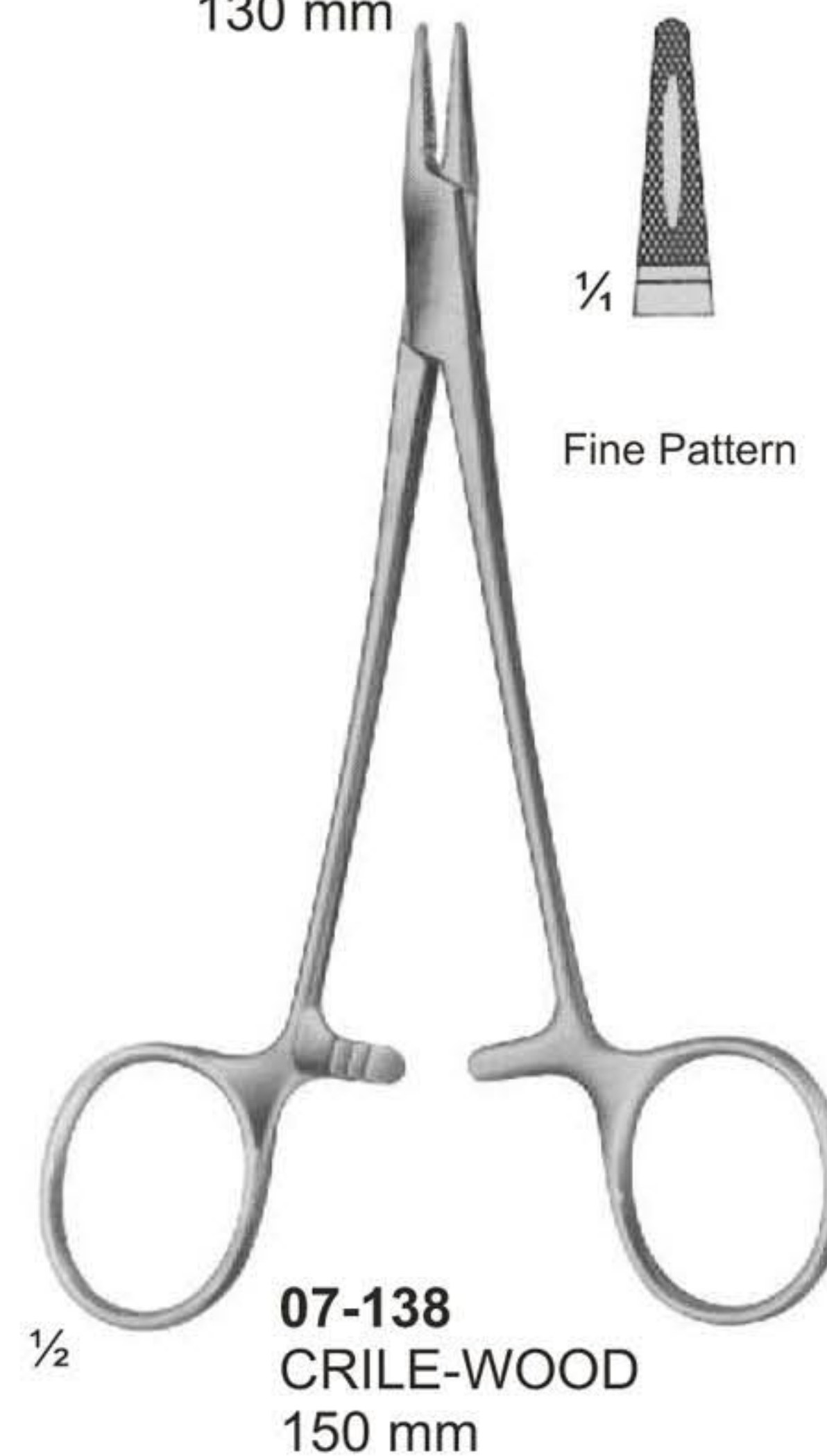
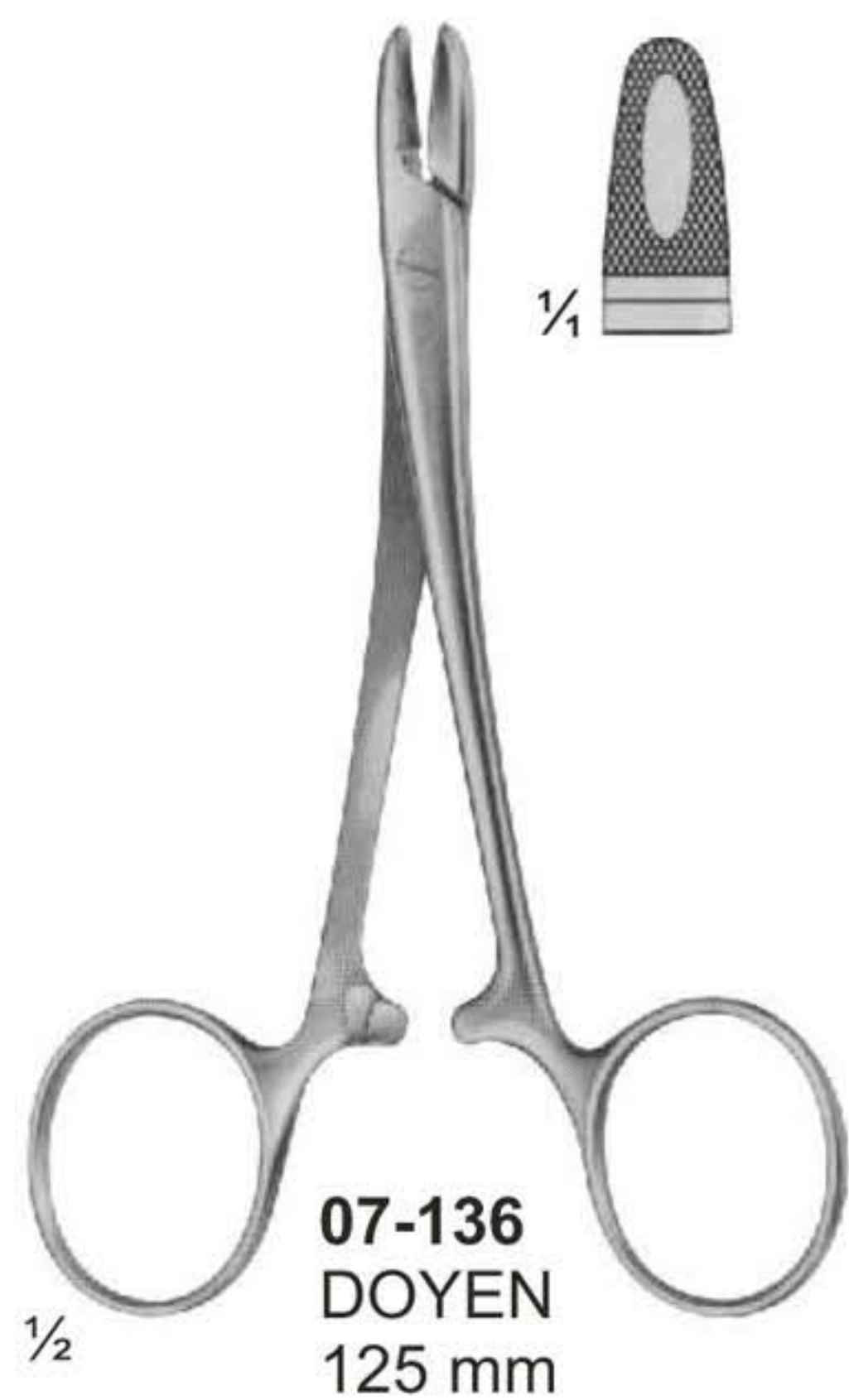
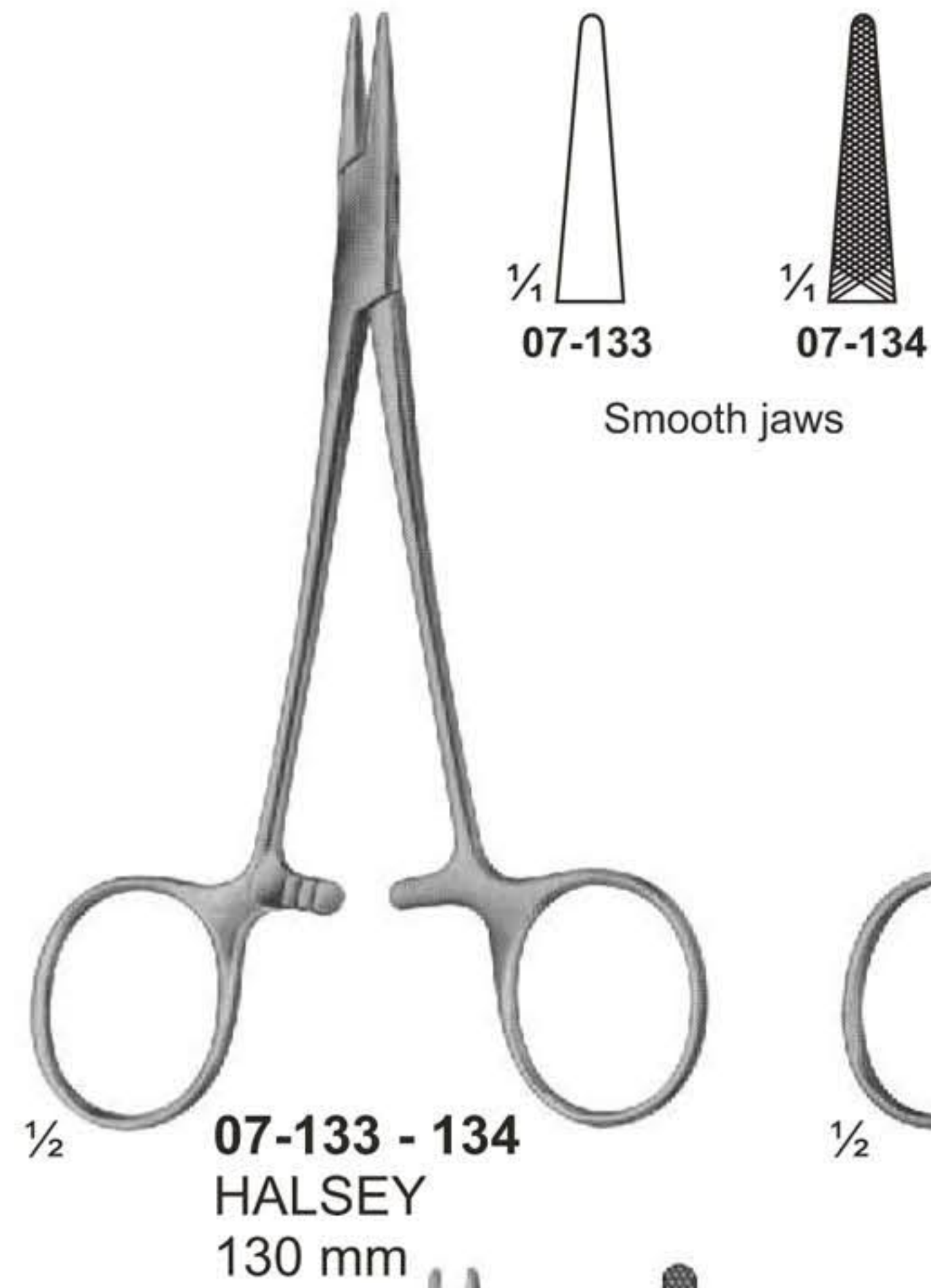
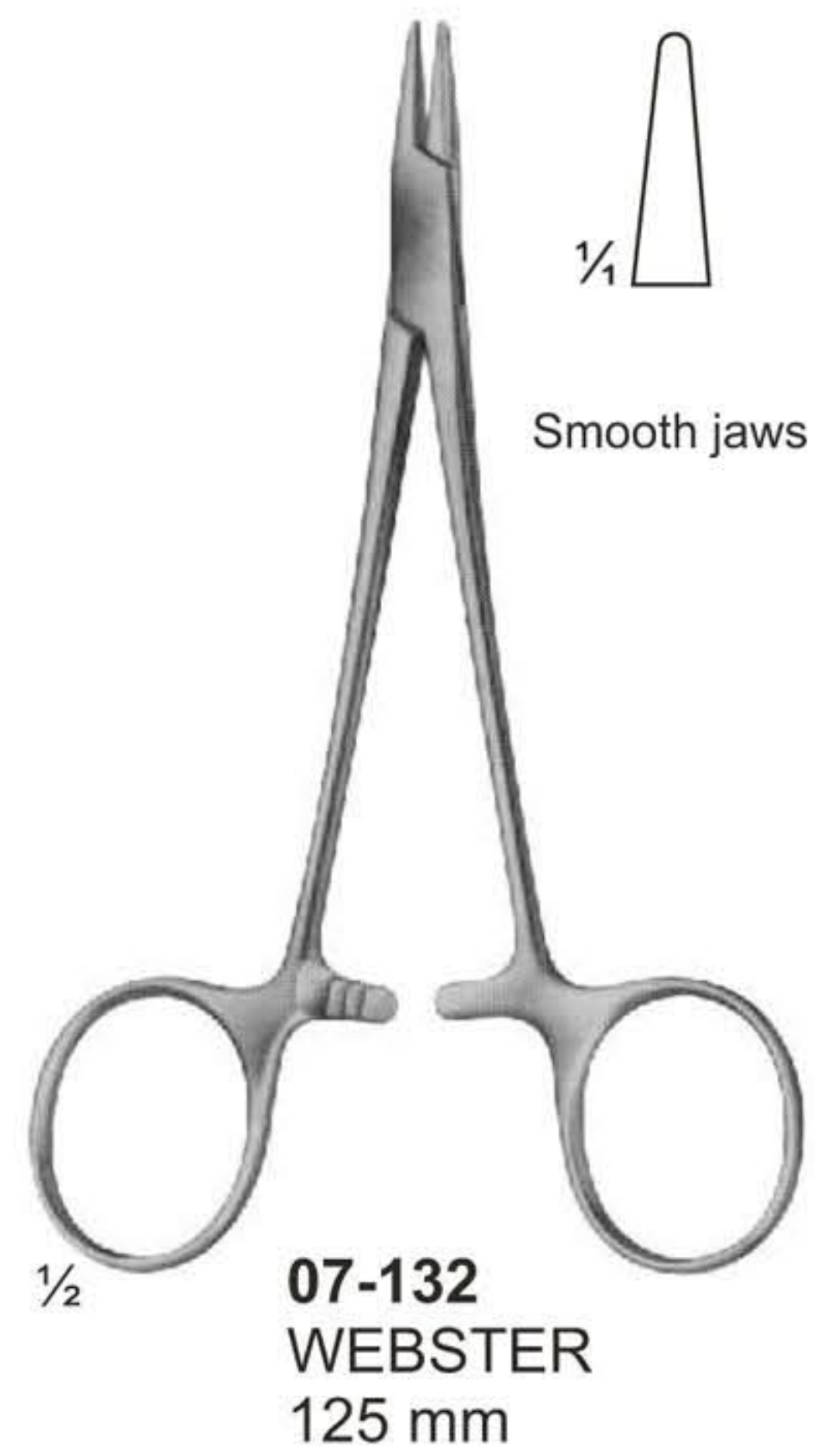



**Needle Holders**

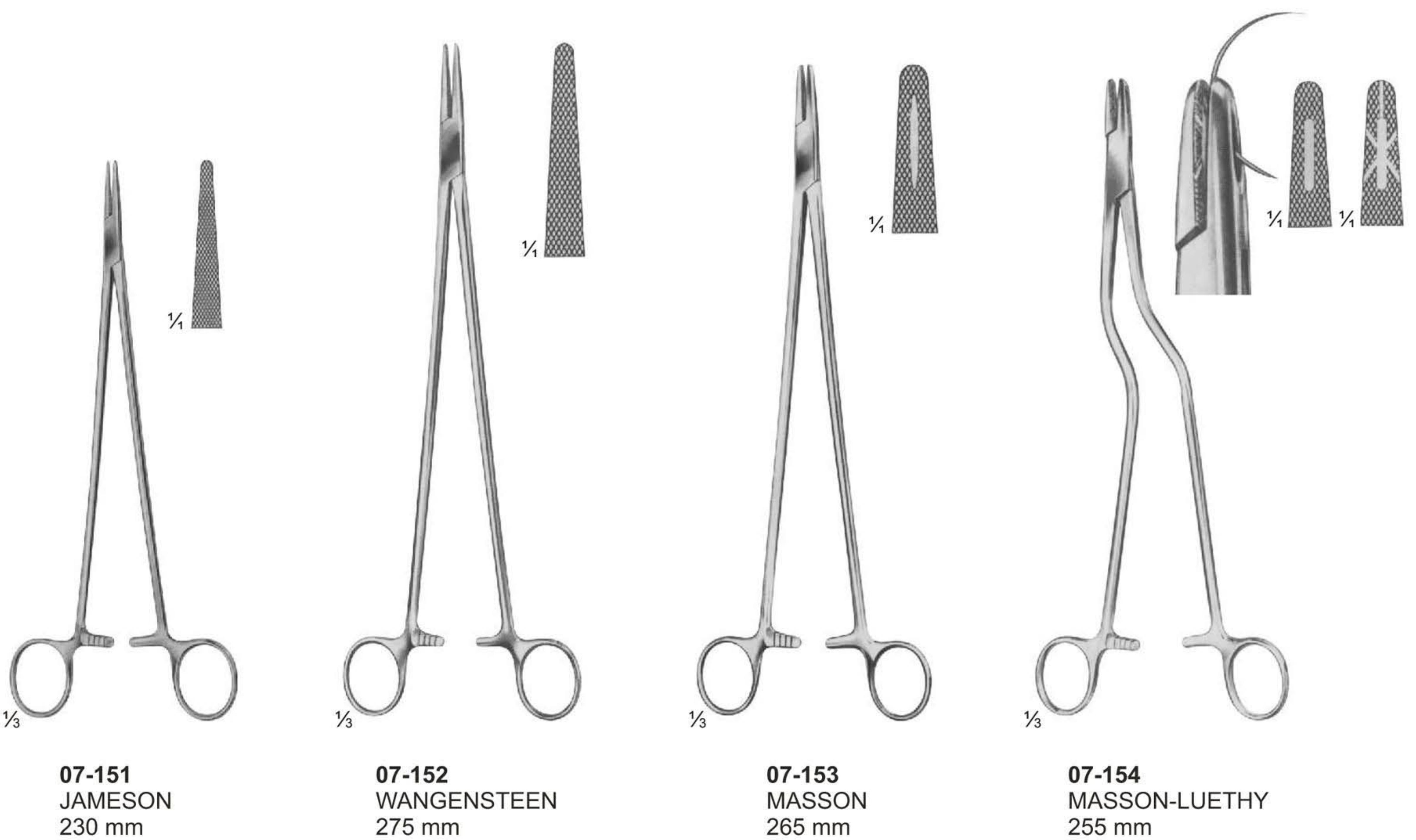



**Needle Holders**

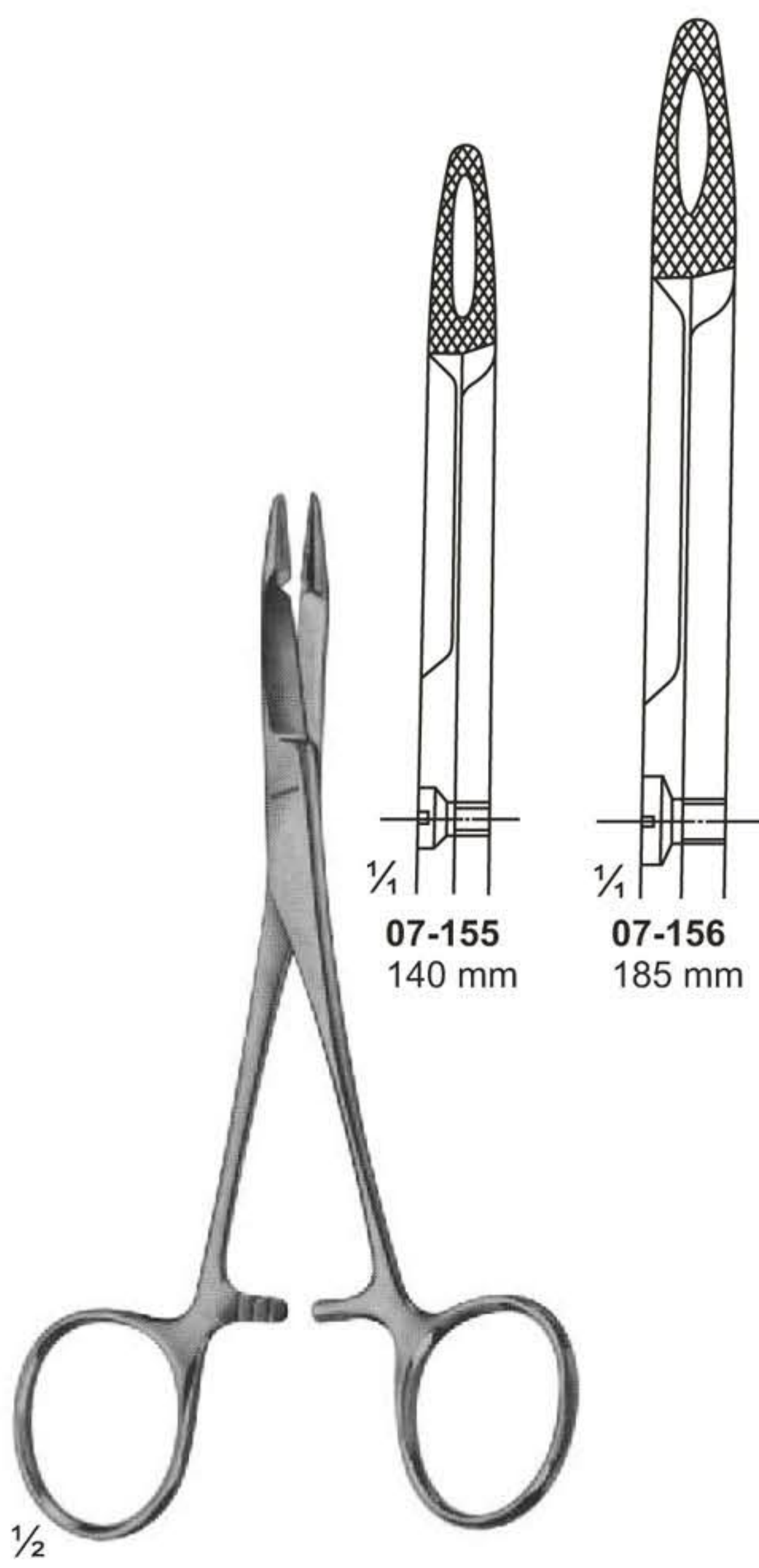

**07-155 - 156**  
HEGAR-OLSEN  
255 mm

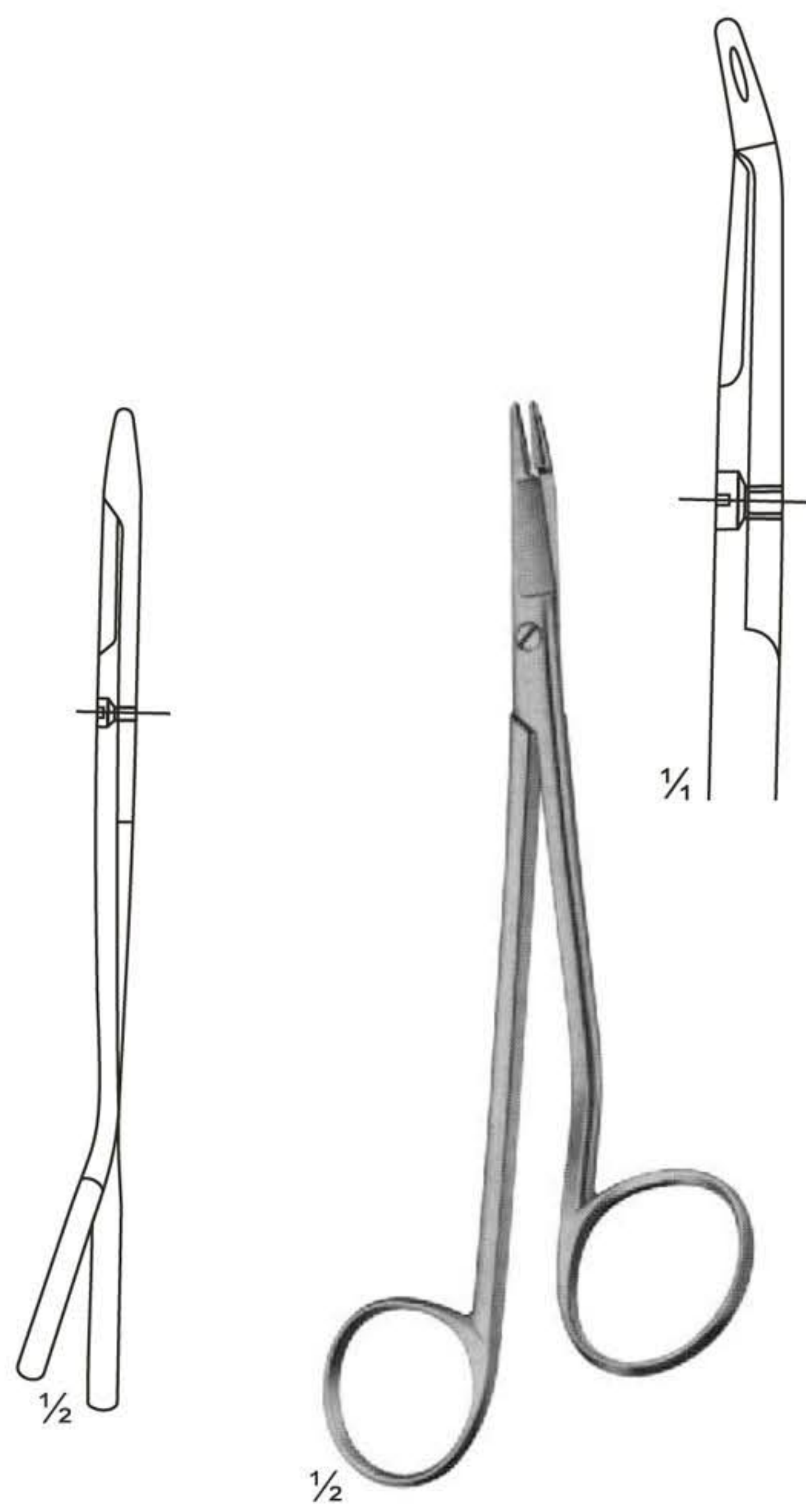

**07-157**  
GILLIES  
150 mm

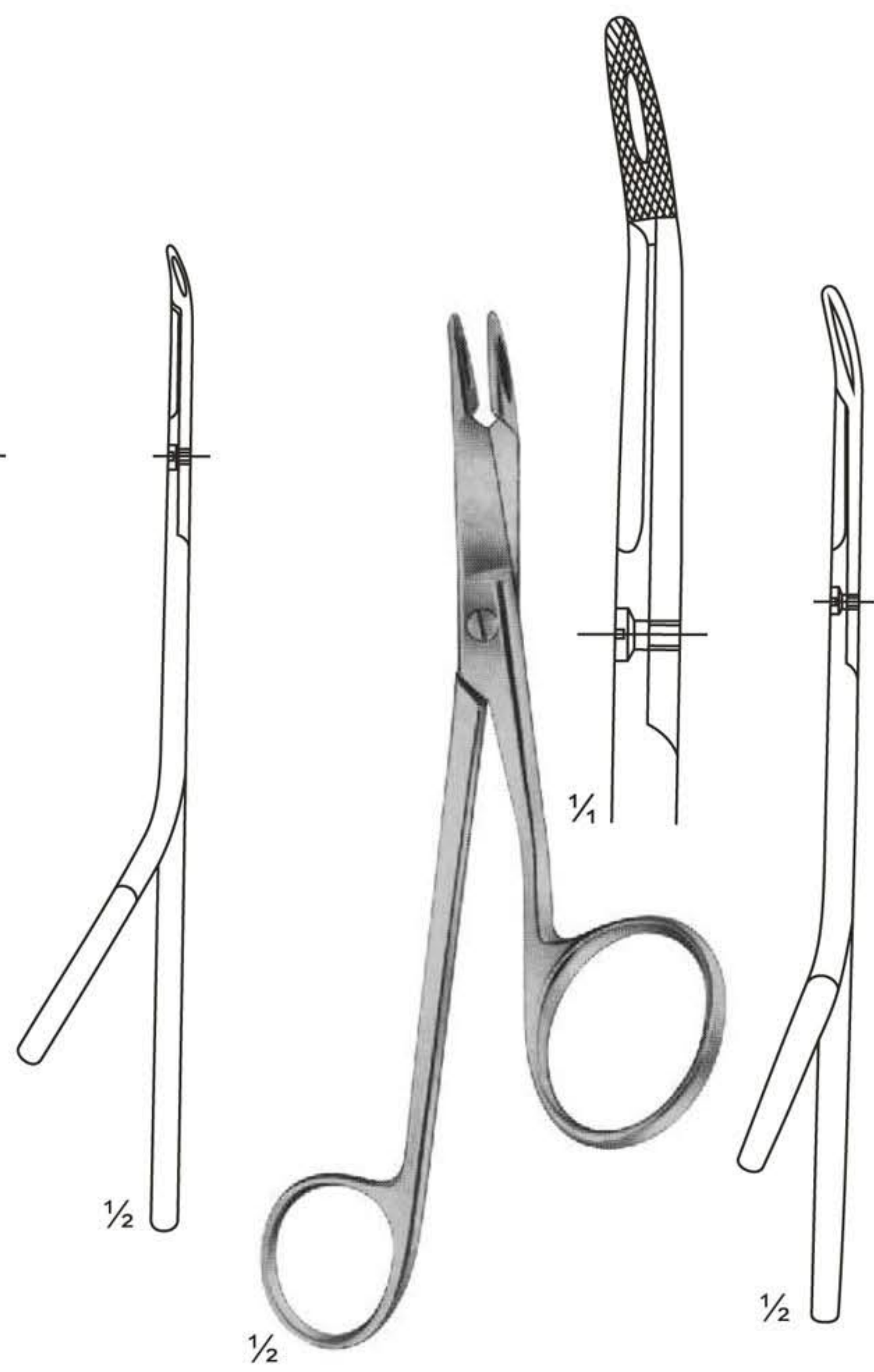

**07-158**  
GILLIES  
160 mm

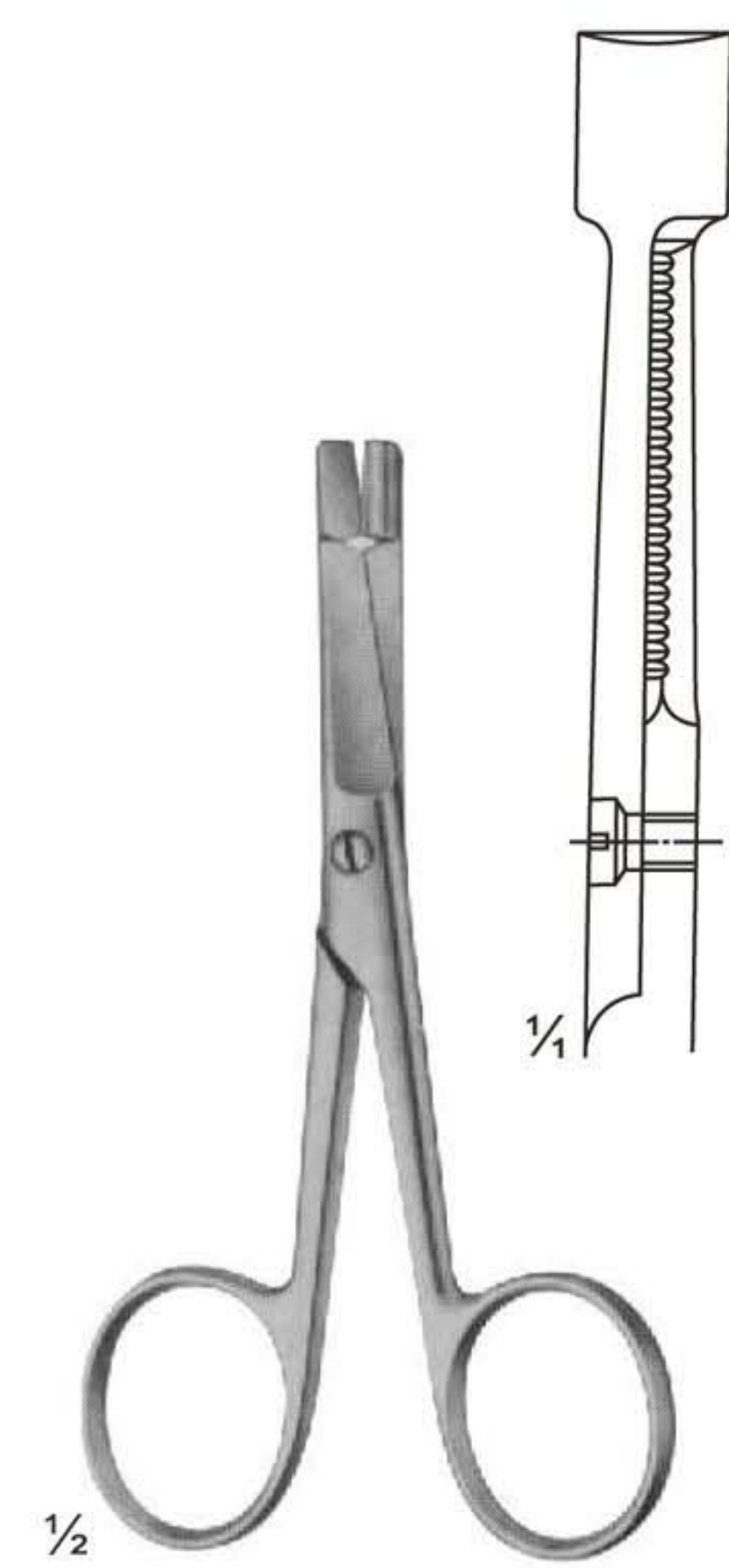

**07-159**  
EISELSBERG  
115 mm

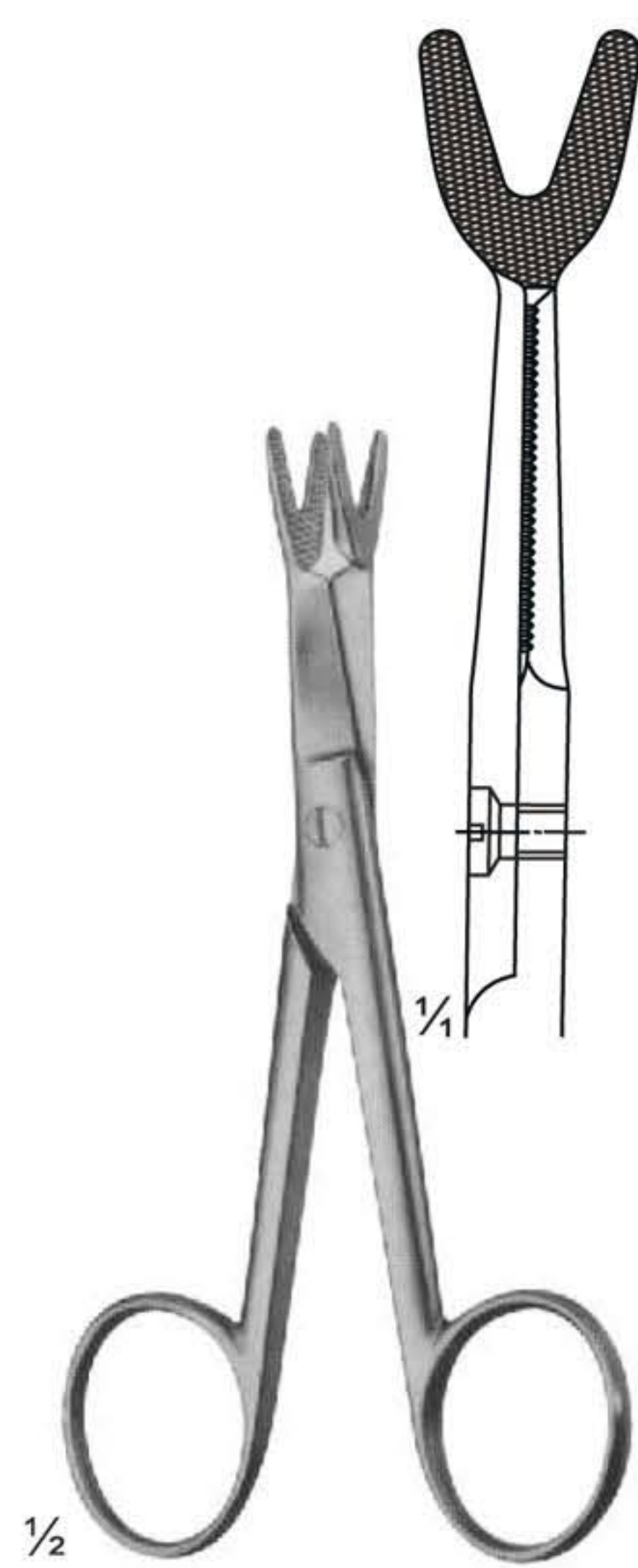

**07-160**  
SCHOEMAKER-LOTH  
125 mm



**07-161**  
CRILE  
150 mm



**07-162**  
TONNIS  
Elastic pattern for  
dura-or intestinal suture  
180 mm



Needle Holders

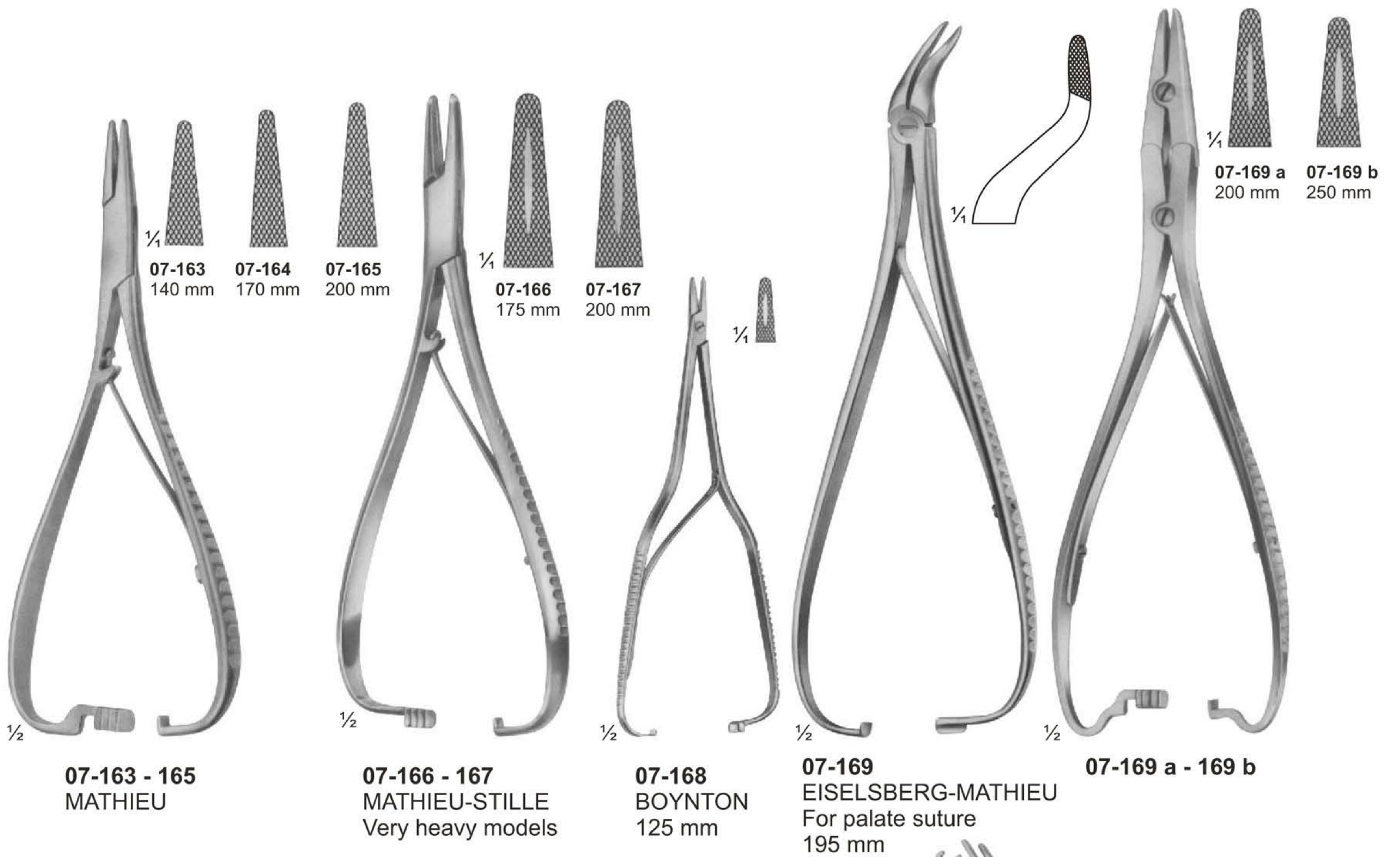



Suture Instruments - Reverdin Needles

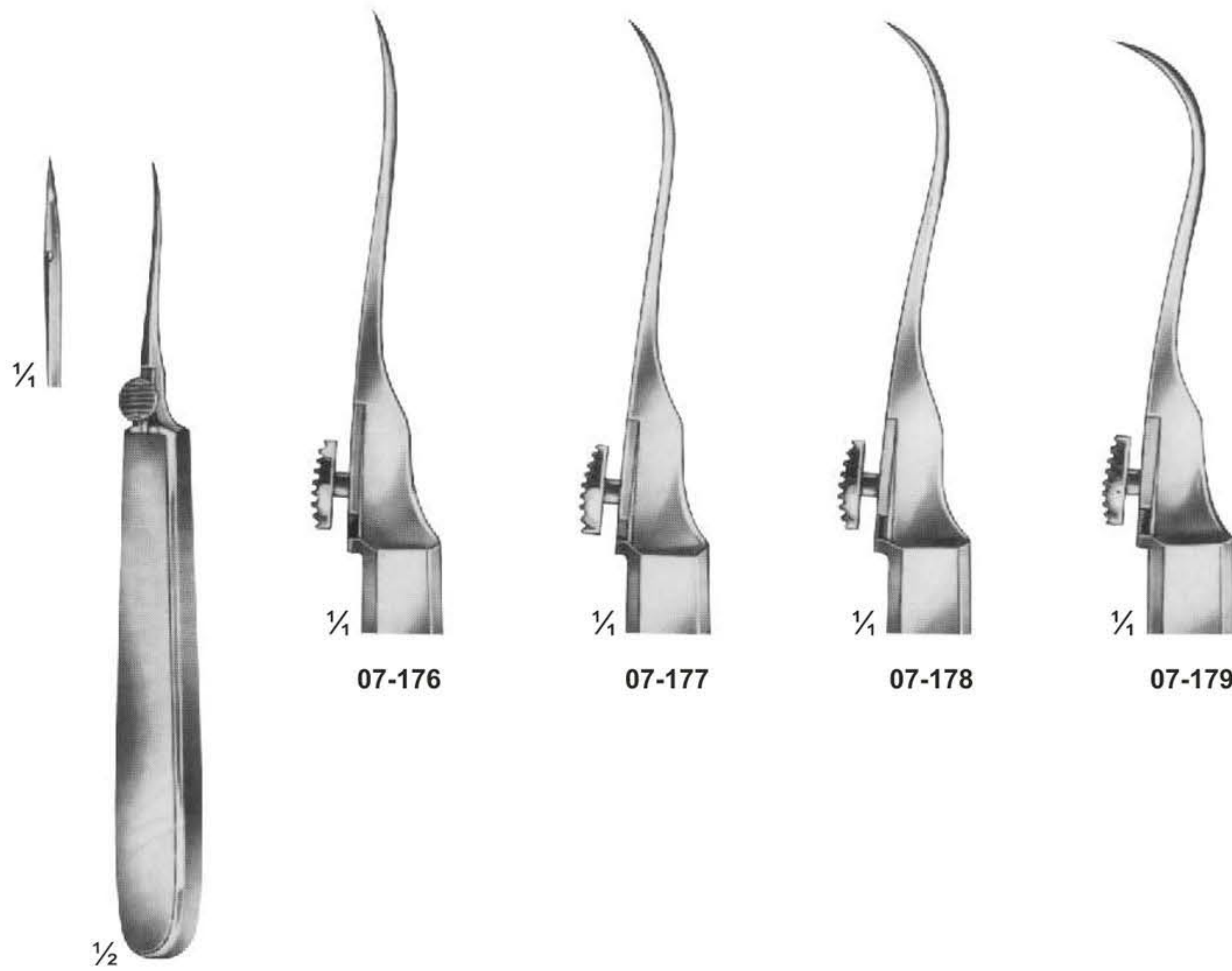

**07-176 - 179**  
REVERDIN  
140 mm



**07-180 - 183**  
REVERDIN  
195 mm

**07-184 - 188**  
REVERDIN  
220 mm



## Suture Instruments - Ligature Needles

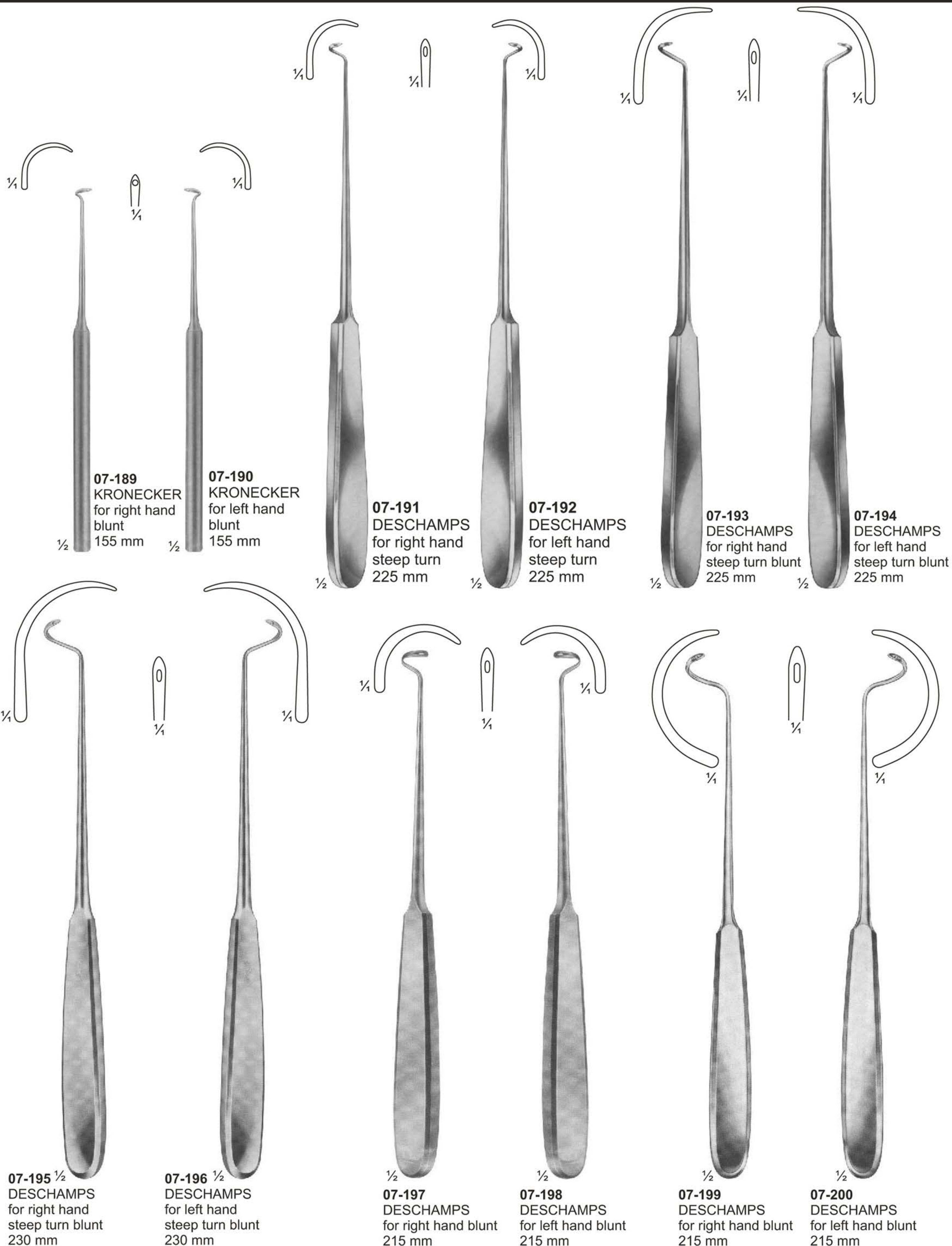



**Suture Instruments - Ligature Needles**



1/2  
**07-201**  
HURD  
for right hand  
sharp  
210 mm



1/2  
**07-202**  
HURD  
for left hand  
sharp  
210 mm



1/2  
**07-203**  
DESCHAMPS  
for right hand  
sharp  
215 mm



1/2  
**07-204**  
DESCHAMPS  
for left hand  
sharp  
215 mm



1/2  
**07-205**  
JONESCO  
Needle for wire suture  
185 mm



1/2  
**07-206**  
CLAUS VAN EICKEN  
Needle for wire suture  
250 mm

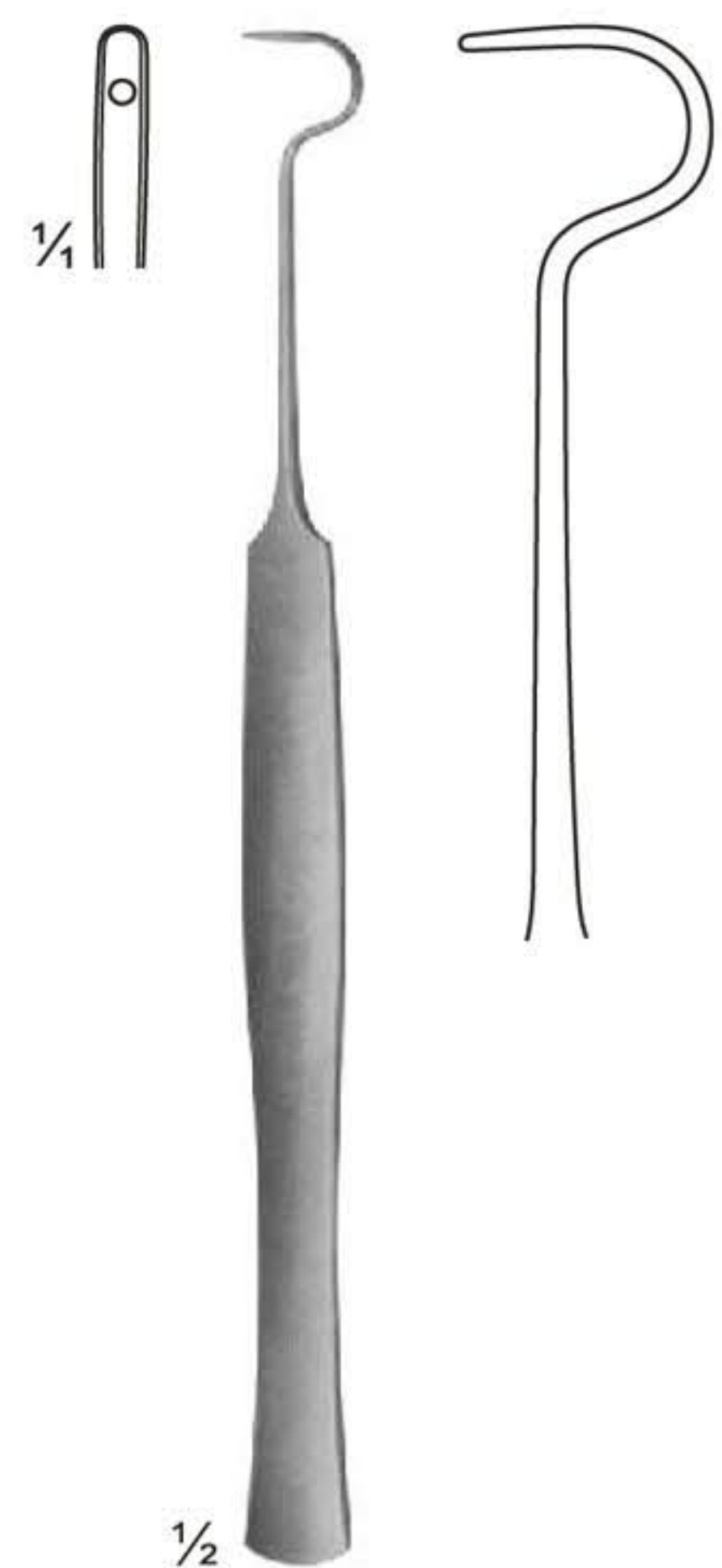

1/2  
**07-207**  
150 mm

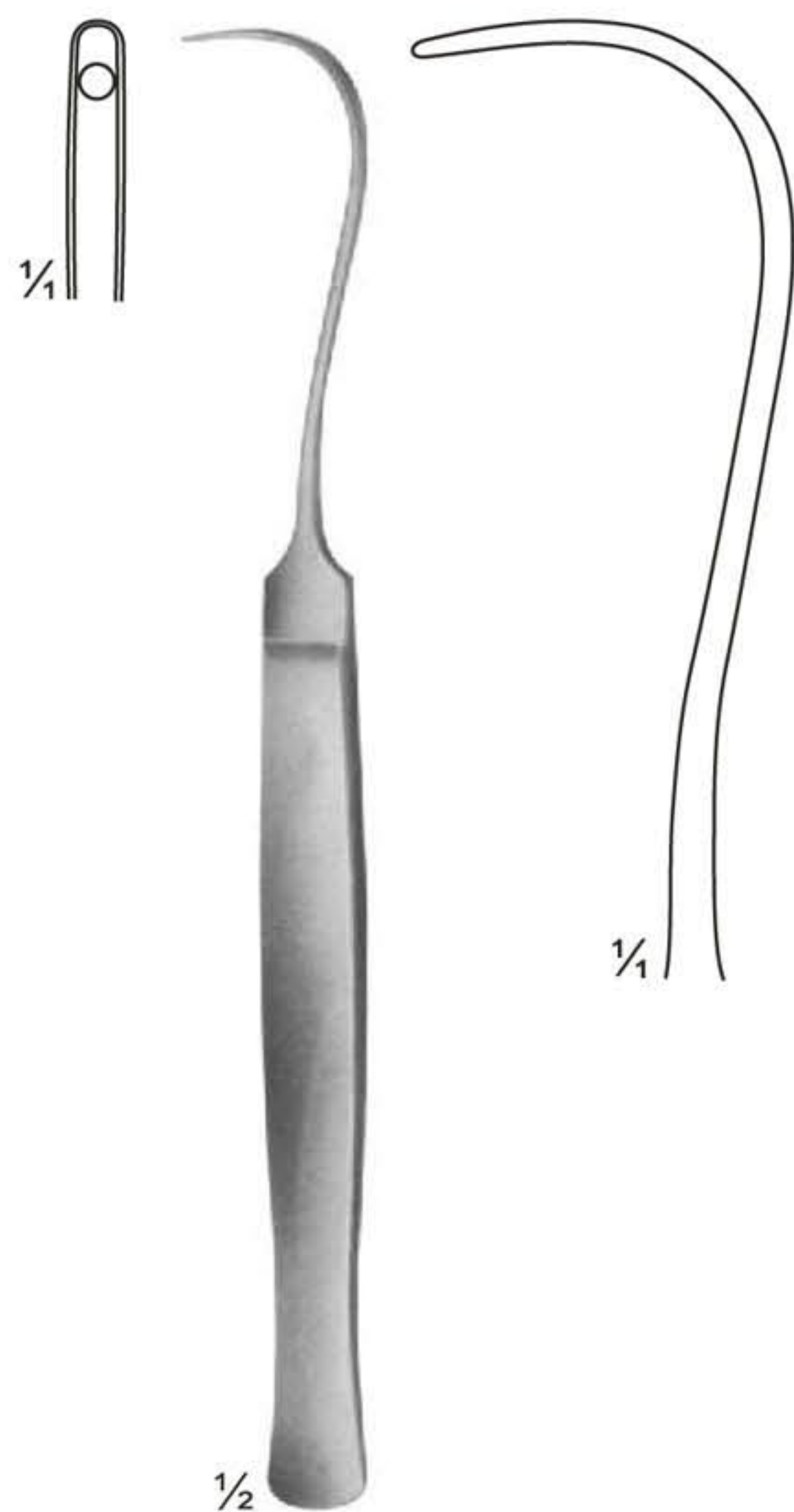

1/2  
**07-208**  
SYME  
170 mm

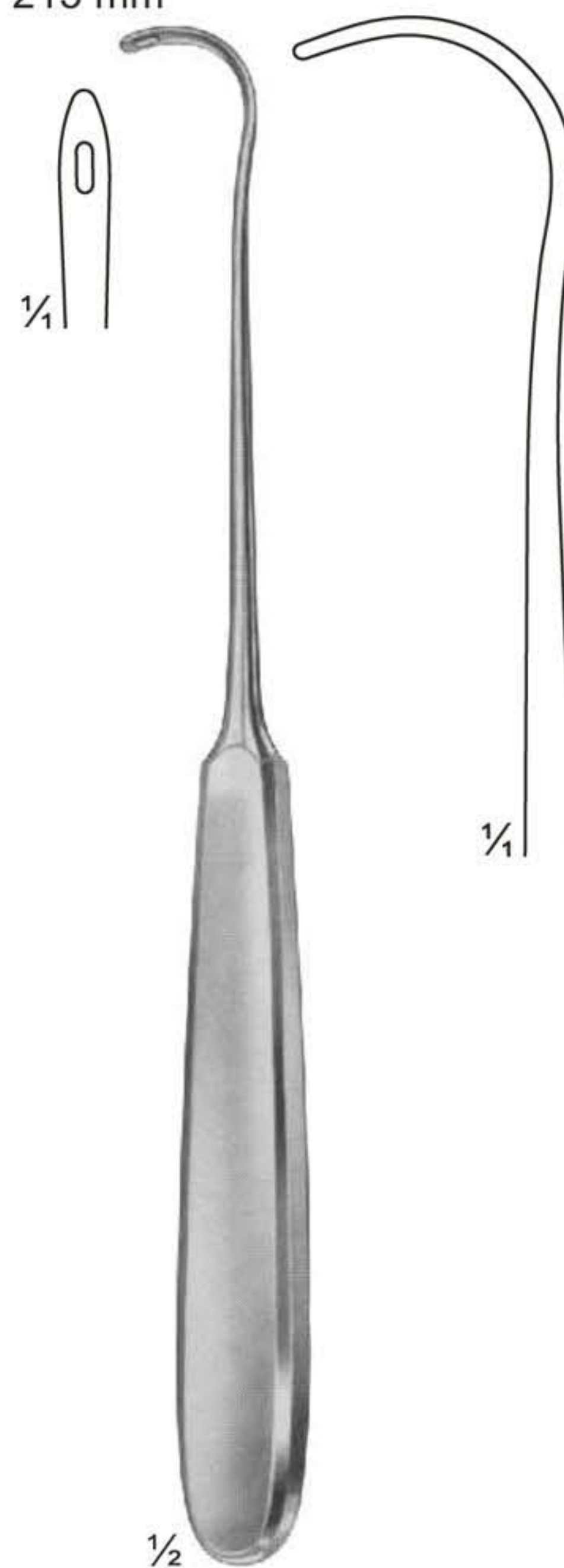

1/2  
**07-209**  
COOPER  
205 mm

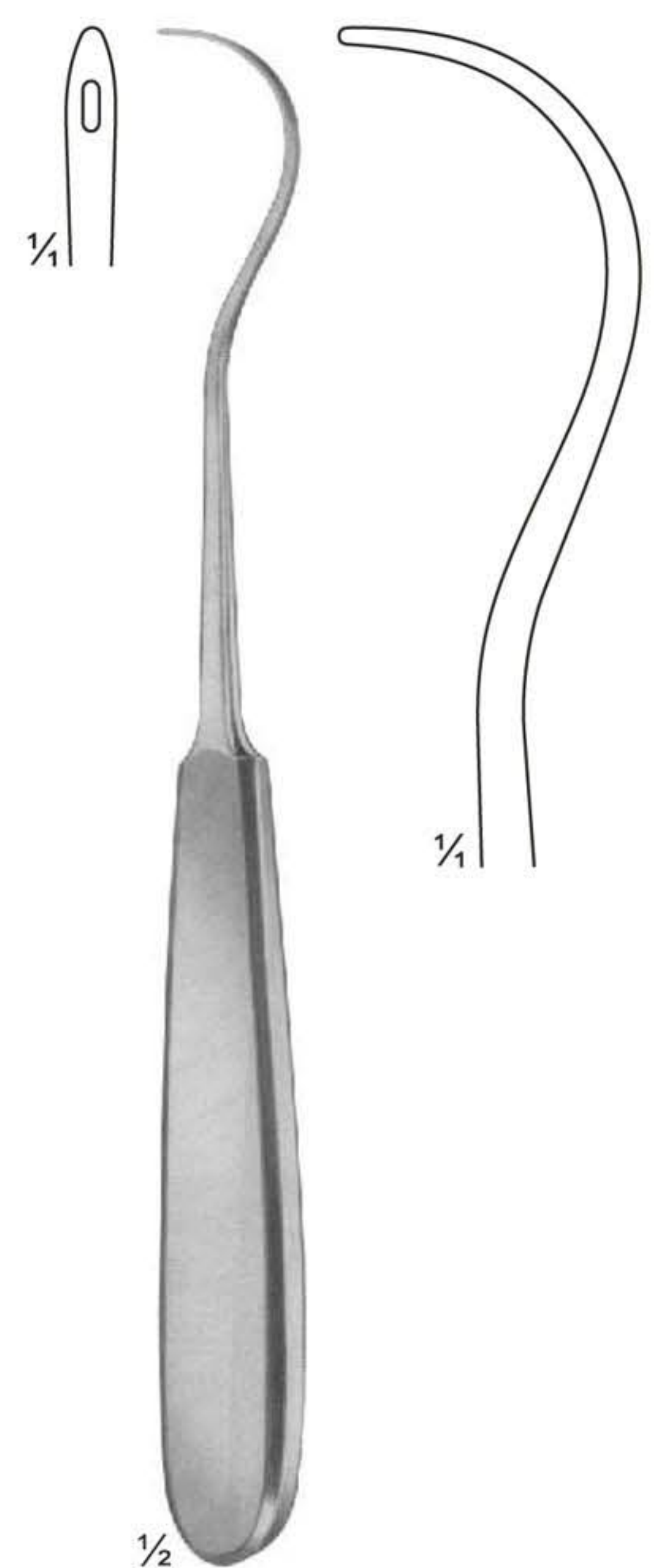

1/2  
**07-210**  
KOCHER  
205 mm



**Ligature Needles**

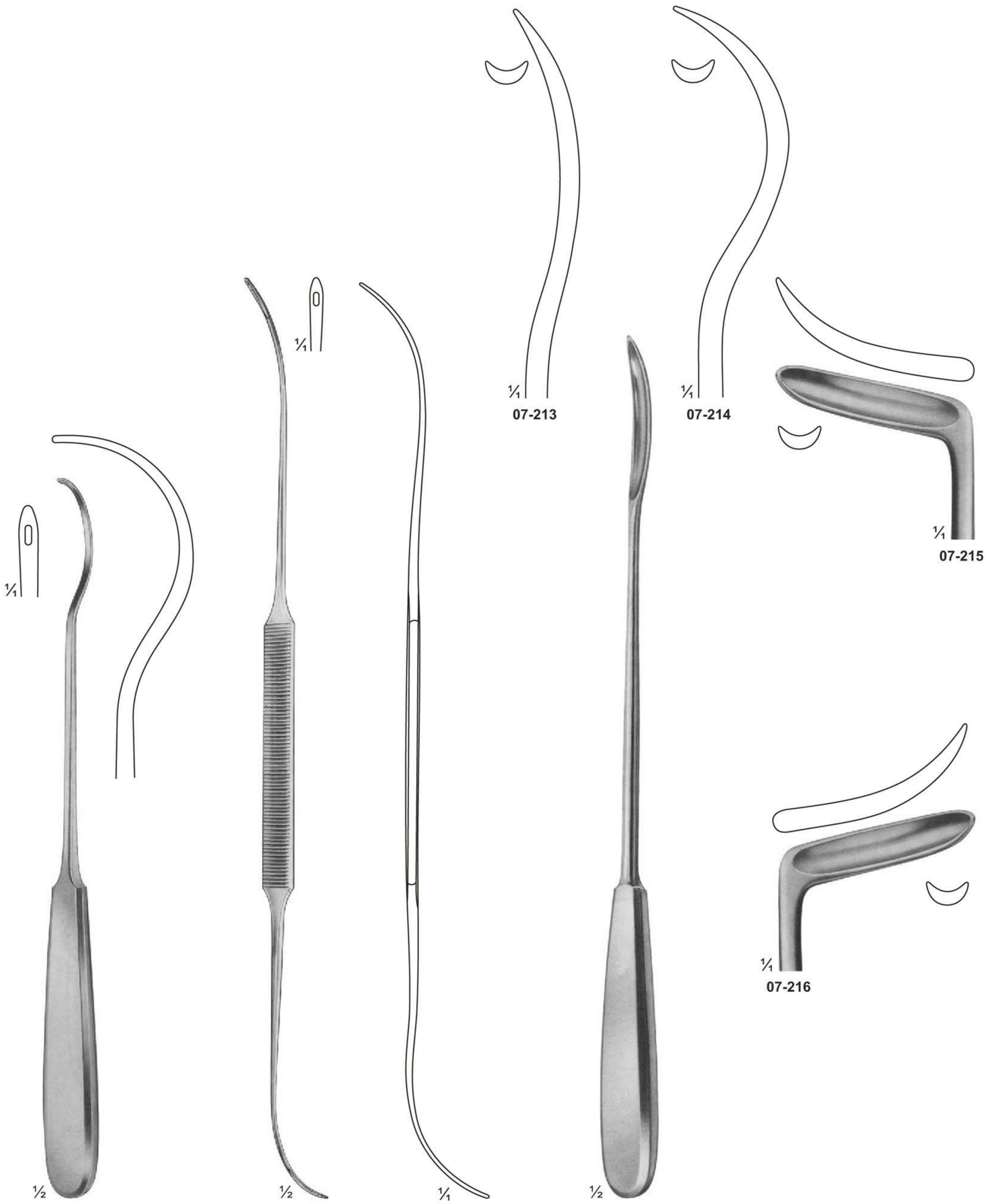

**07-211**  
BRUNNER  
240 mm

**07-212**  
SCHMIEDEN-DICK  
320 mm

**07-213 - 216**  
BRUNNER  
Guiding Probes  
300 mm







# Probes



**07-242** 2,5 mm  
**07-243** 2,5 mm  
**07-244** 3,0 mm

1/2

**07-242** 145 mm  
**07-243** 160 mm  
**07-244** 200 mm  
Probes with eye



1,5 mm

1/2

**07-245**  
Myrtle leaf probe  
145 mm



2,0 mm

1/2

**07-246** 130 mm  
**07-247** 145 mm  
**07-248** 160 mm  
**07-249** 180 mm  
**07-250** 200 mm



1/2

**07-251**  
Probes



1/2

**07-252**  
Double ended probe,  
malleable, diam. of tips  
3 mm with hole  
190 mm



**07-253**  
Double ended probes,  
tin, malleable,  
diam. of tips  
3,5 mm with hole  
250 mm, 300 mm



1/4

**07-254**  
Double ended probes,  
tin, malleable,  
diam. of tips 4 mm  
400 mm



1/3

Ø tip  
**07-255** 1,5 mm  
**07-256** 2,0 mm  
**07-257** 2,5 mm  
300 mm



# Probes



**07-242** 2,5 mm  
**07-243** 2,5 mm  
**07-244** 3,0 mm

1/2

**07-242** 145 mm  
**07-243** 160 mm  
**07-244** 200 mm  
Probes with eye



1,5 mm

1/2

**07-245**  
Myrtle leaf probe  
145 mm



2,0 mm

1/2

**07-246** 130 mm  
**07-247** 145 mm  
**07-248** 160 mm  
**07-249** 180 mm  
**07-250** 200 mm



1/2

**07-251**  
Probes



1/2

**07-252**  
Double ended probe,  
malleable, diam. of tips  
3 mm with hole  
190 mm



**07-253**  
Double ended probes,  
tin, malleable,  
diam. of tips  
3,5 mm with hole  
250 mm, 300 mm



1/4

**07-254**  
Double ended probes,  
tin, malleable,  
diam. of tips 4 mm  
400 mm



1/3

Ø tip  
**07-255** 1,5 mm  
**07-256** 2,0 mm  
**07-257** 2,5 mm  
300 mm



**Probes - Spatulas - Cotton Applicators**



**07-258**  
STACKE  
100 mm



**07-259**  
KILLIAN  
165 mm



**07-260**  
160 mm



**07-261**  
SEIFFERT  
180 mm



**07-262**  
BOWMAN  
130 mm

German Silver



**07-263**  
SPATULA  
145 mm



**07-264**  
SPATULA  
145 mm



**07-265**  
Modell PICCOLO  
Round Serrated  
110 mm



**07-266**  
Modell PICCOLO  
Triangular Serrated end  
110 mm



**07-267**  
FARRELL  
Round Serrated end  
110 mm



**07-268**  
LATHBURY-FARRELL  
Triangular Serrated end  
110 mm





# Cotton Applicators



**07-269**  
BUCK  
Rough, spiral end  
120 mm

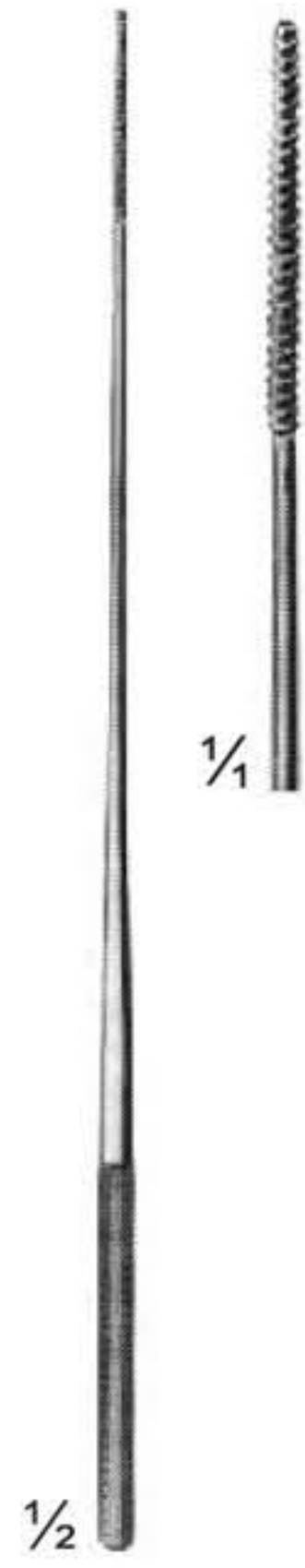

**07-270**  
Triangular  
serrated end  
140 mm

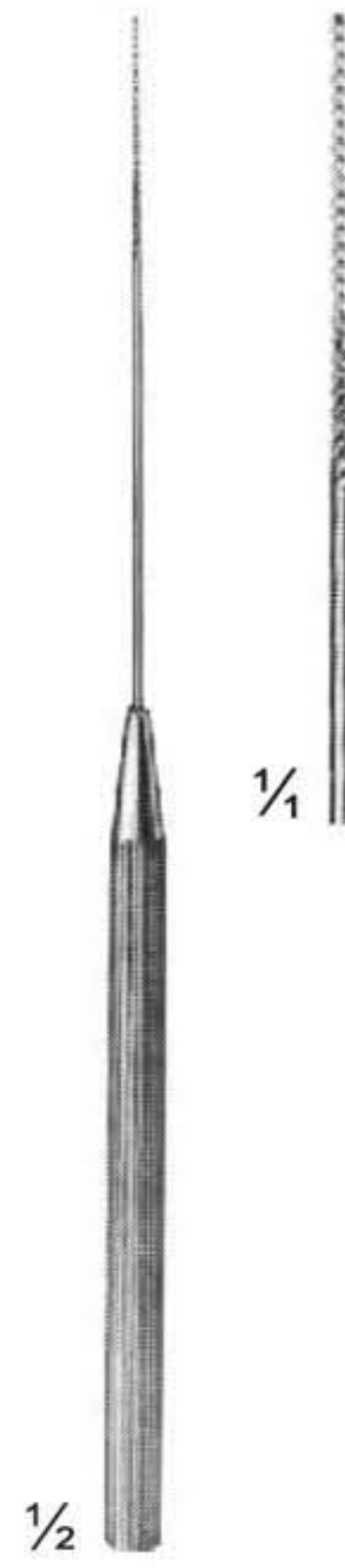

**07-271**  
Rough, spiral end  
140 mm



**07-272**  
Rough, spiral end  
140 mm



**07-273**  
Rough, spiral end  
140 mm



**07-274**  
FARRELL  
Round,  
serrated end  
140 mm



**07-275**  
LATHBURY-FARRELL  
Triangular,  
serrated end  
140 mm

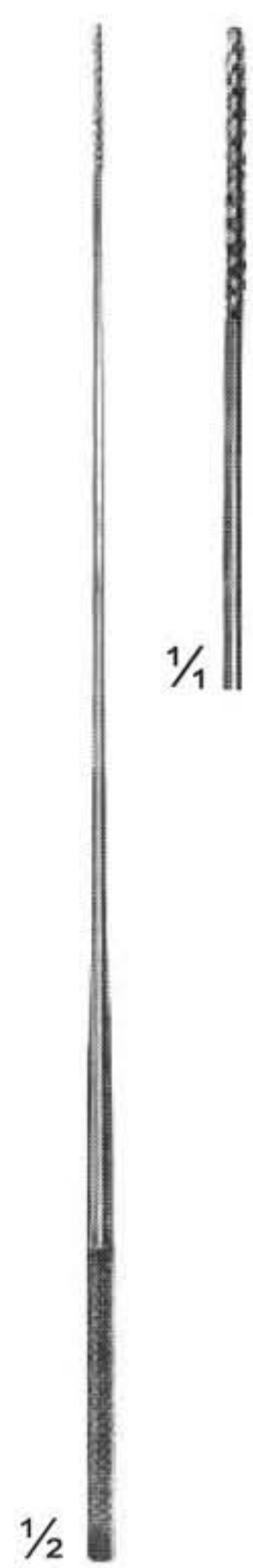

**07-276**  
FARRELL  
Rough,  
spiral end  
160 mm



**07-277**  
LATHBURY-FARRELL  
Triangular,  
serrated end  
160 mm



**07-278**  
Triangular,  
serrated end  
160 mm



**07-279**  
Rough,  
spiral end  
180 mm



**07-280**  
Rough,  
spiral end  
180 mm



**07-281**  
Rough,  
spiral end  
270 mm



## Clip Applying Forceps - Suture Set



**07-282**  
MICHEL  
125 mm



**07-283**  
HEGENBARTH  
120 mm



**07-284**  
WACHENFELDT  
120 mm



**07-285**  
WACHENFELDT  
120 mm



**07-286**  
MICHEL  
125 mm



**07-287**  
MICHEL modif.  
130 mm



**07-288**  
HEATH  
135 mm

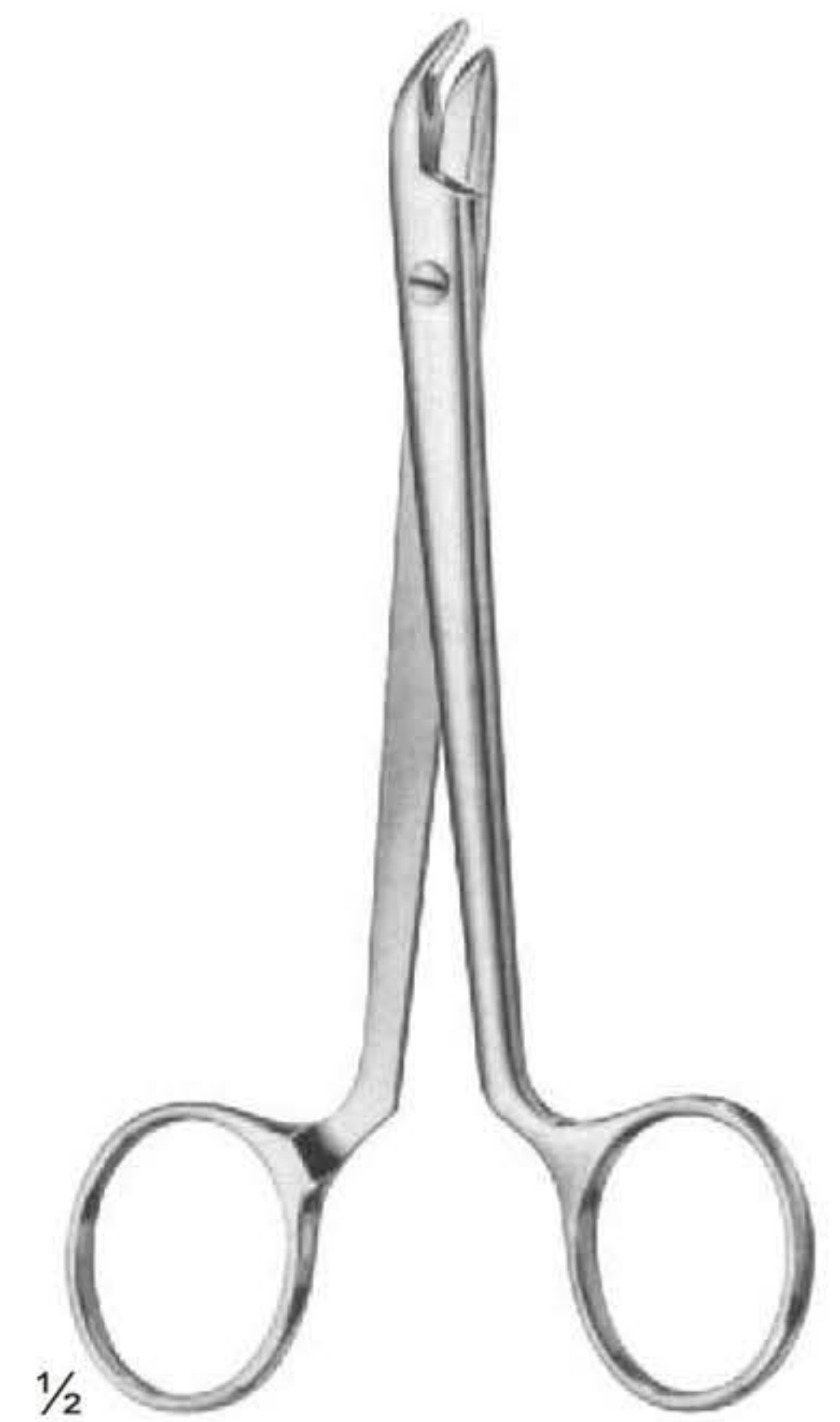

**07-289**  
COLLIN  
135 mm





## Clip Applying Forceps - Suture Set



**07-290**

Suturing instruments set, in metal case consisting of: Scissors, curved, sharp/sharp, 115mm  
25 MICHEL clip, 16 x 3mm  
1 Delicate tissue forceps, 130mm  
1 Scalpel, bellied  
1 MATHIEU needle holder, 140mm  
1 Perforated metal case, stainless containing:  
1 Suture needle  
1 item 1 item



**07-291**

Pocket instrument set, in metal case consisting of:

**Bottom tray**

1 MATHIEU needle holder, 140mm  
1 MICHEL clip forceps, combined  
1 Myrtle leaf probe, 130mm  
1 Sharp double curette  
1 Skin hook  
1 Detachable scalpel handle, no.4  
1 Perforated metal case, containing  
6 Scalpel blades BB 520  
1 Perforated metal case, stainless, containing  
1 Suture needle  
1 item  
1 item

**Top tray**

1 Tissue forceps, 130mm  
1 KOCHER haemostatic forceps, 130mm  
1 Straight surgical scissors, 130mm  
1 Dissecting forceps, 130mm  
1 FEILCHENFELD splinter forceps, 115mm  
25 MICHEL clip, 16 x 3mm  
1 Flacon of suture skin, sterile in alcohol

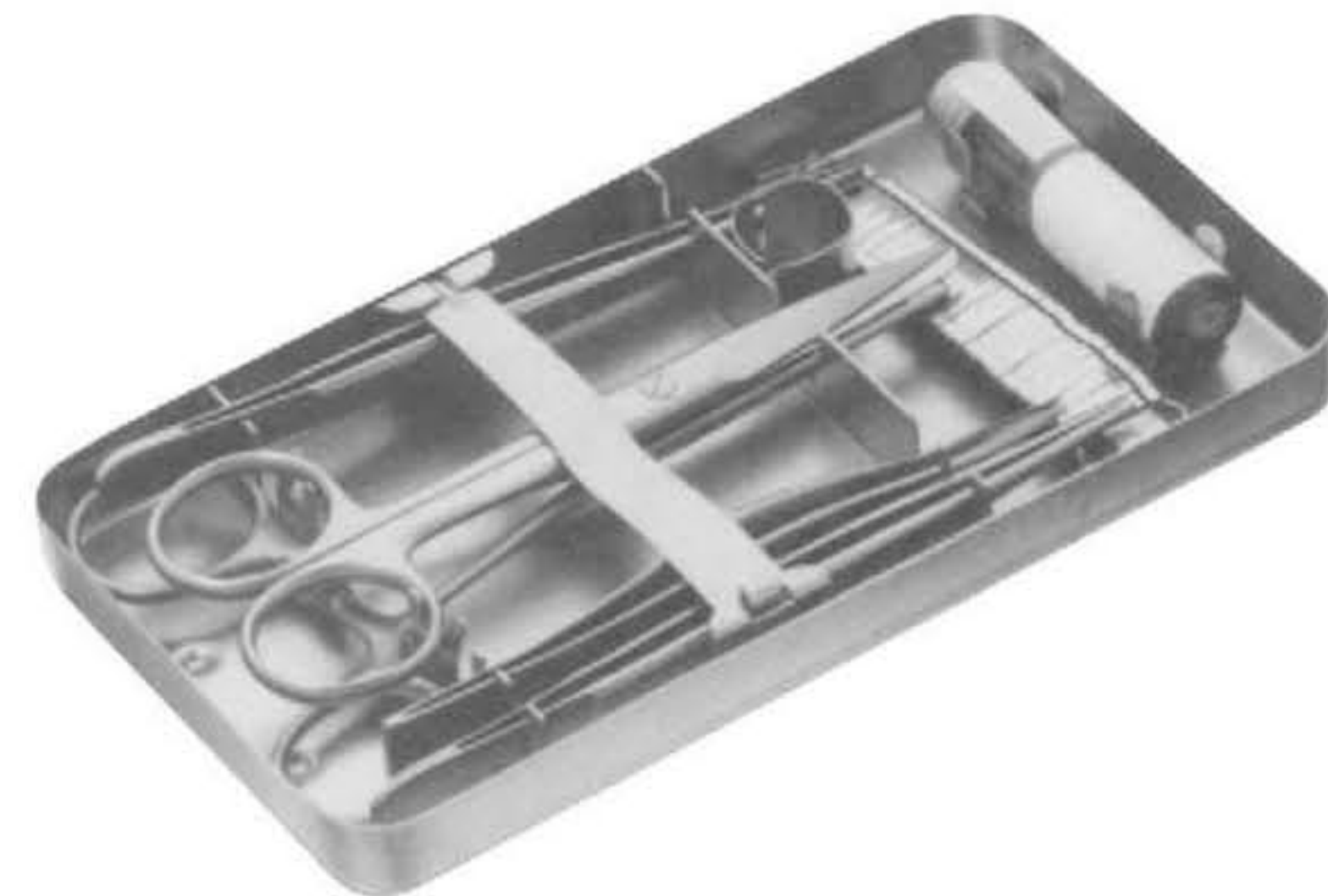

**07-292**

Pocket instrument set, in metal case consisting of:

**Bottom tray**

1 MAYO-HEGER needle holder, 150mm  
1 MICHEL clip forceps, combined  
1 Myrtle leaf probe, 130mm  
1 Sharp double curette  
1 Skin hook  
1 Detachable scalpel handle, no. 4  
1 Perforated metal case, consisting  
6 Scalpel blades BB 520  
1 Perforated metal case, stainless, consisting:  
1 Suture needle  
1 item. & 1 item

**Bottom tray**

1 Tissue forceps, 130mm  
1 CRILE haemostatic forceps, 140mm  
1 Straight surgical scissors, 130mm  
1 Dissecting forceps, 130mm  
1 FEILCHENFELD splinter forceps, 115mm  
25 MICHEL clip, 16 x 3mm  
1 Flacon of suture silk, sterile in alcohol

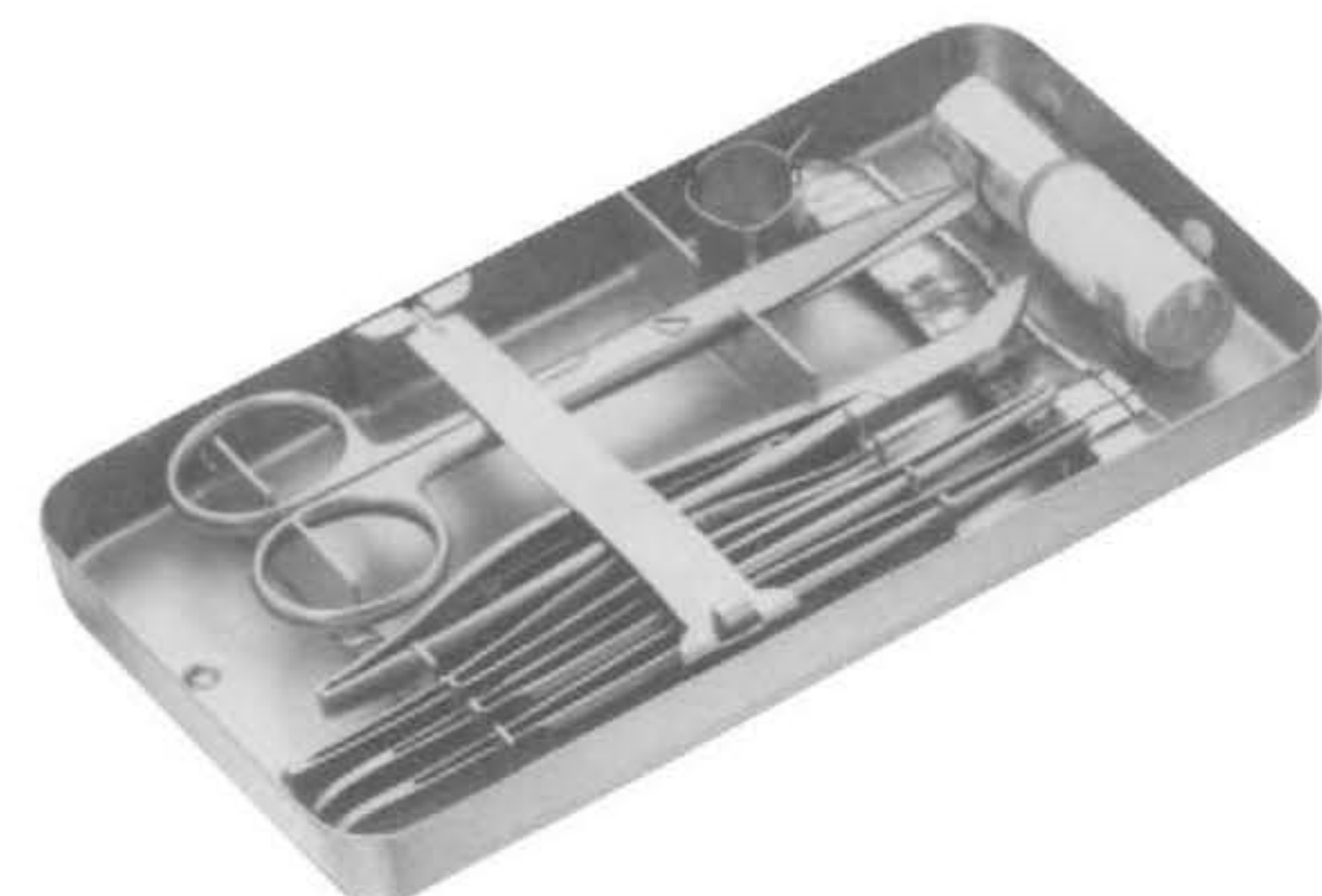



## Clip Applying Forceps - Suture Set

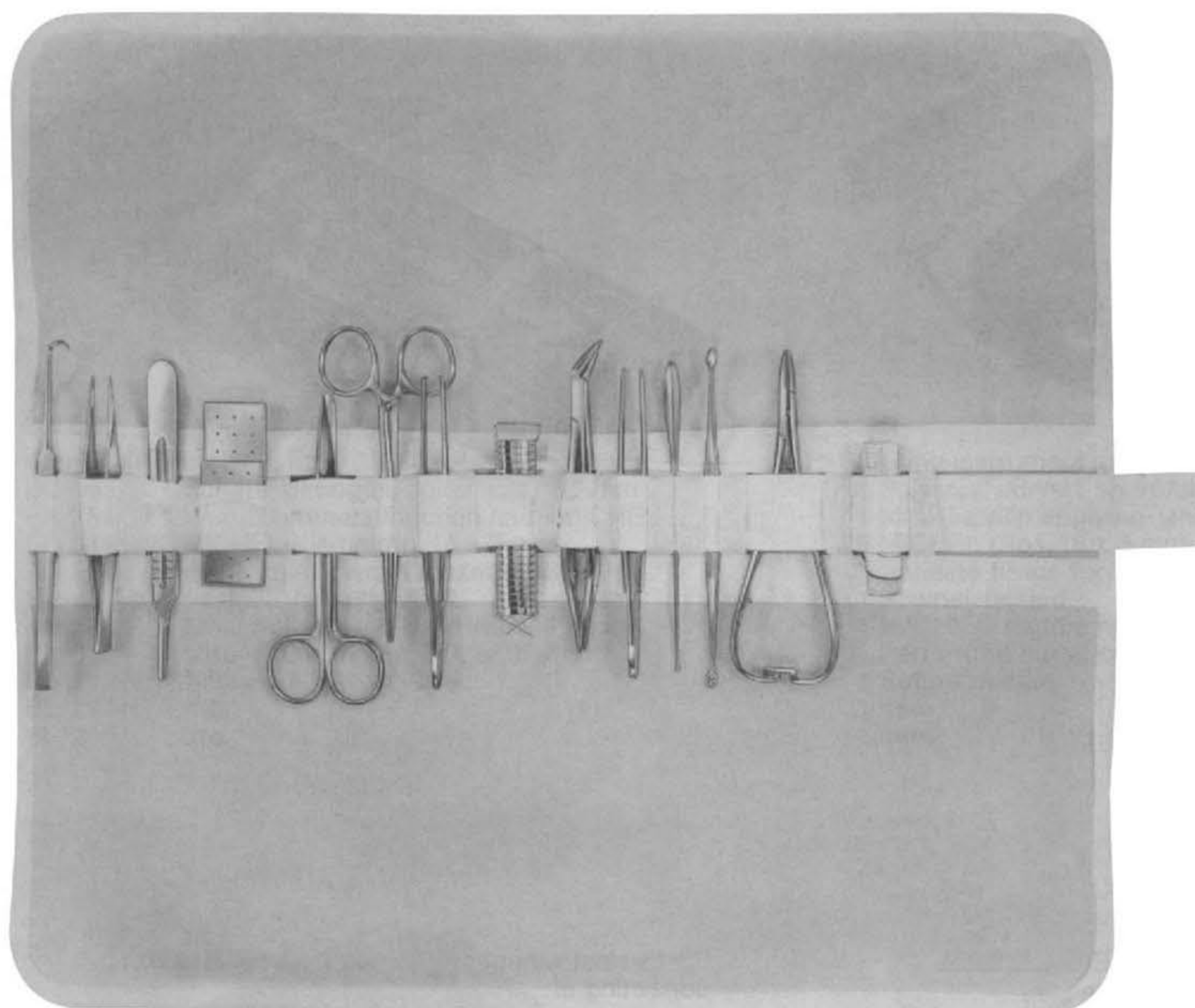

**07-293**

Pocket instrument set in metal case 170 x 90mm with sterilizable canvas roll consisting of:

- 1 Myrtle leaf probe, 130mm
- 1 Sharp double curette
- 1 FEILCHENFELD splinter forceps, 115mm
- 1 Dissecting forceps, 130mm
- 1 Tissue forceps, 130mm

- 1 Straight surgical scissors, 130mm
- 1 Scalpel handle no. 4
- 1 Perforated metal case, consisting 6 scalpel blades BB 520
- 1 KOCHER haemostatic forceps, 130mm
- 1 Skin hook
- 1 MATHIEU needle holder, 140mm
- 1 Tube of suture skin, sterile in alcohol
- 1 MICHEL clip forceps, 120mm

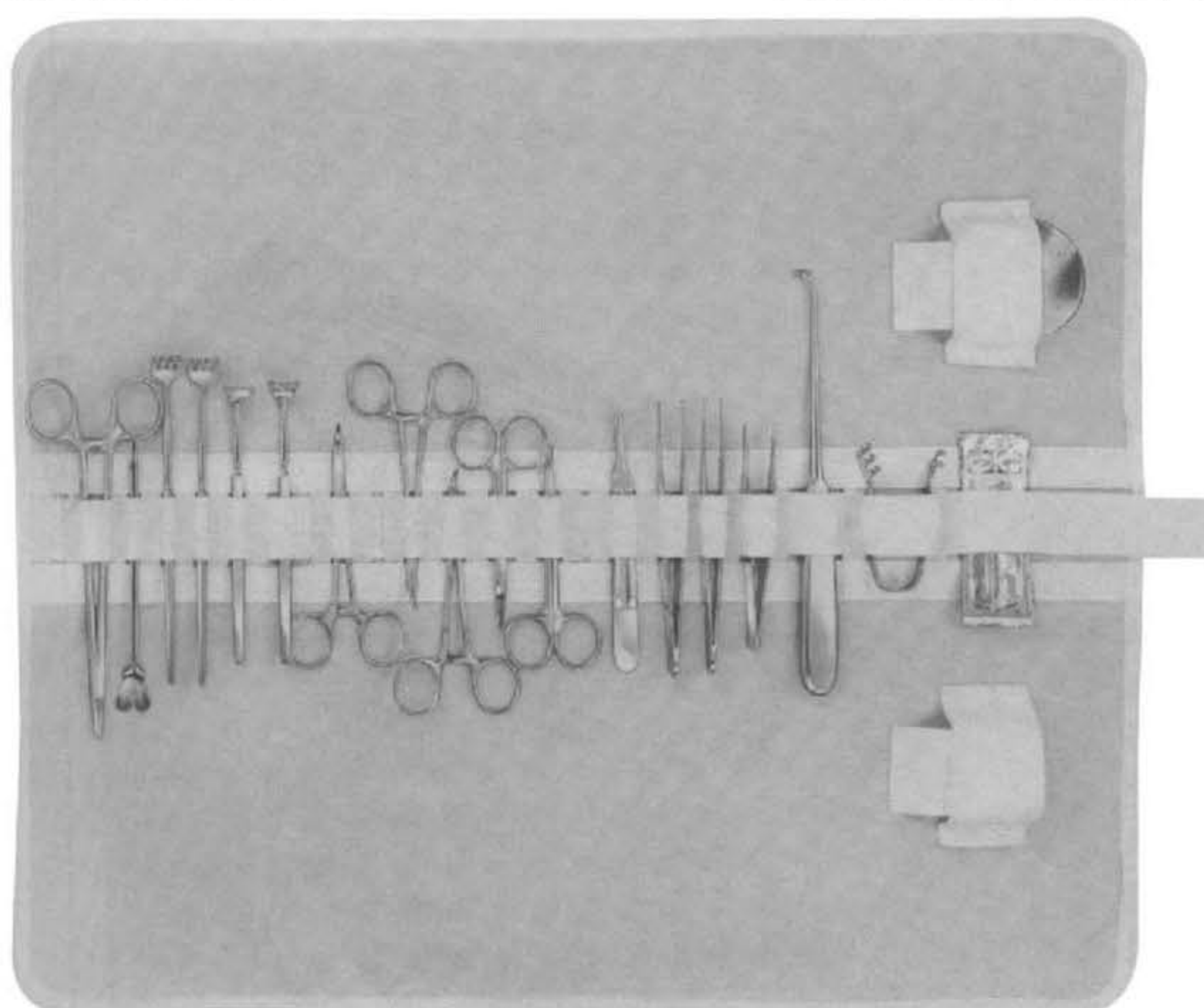
- 25 MICHEL clip, 16 x 3mm
- 1 Perforated metal case, stainless, consisting:
- 1 Suture needle
- 1 item
- 1 item

**07-294**

Venae sectio set, in sterilizable canvas roll consisting of:

- 1 Tissue forceps, 1 x 2 teeth, 140mm
- 1 Dissecting forceps, 145mm
- 1 FEILCHENFELD straight scissors, sharp, 110mm
- 1 curved scissors, blunt, 115mm
- 1 HALSTED mosquito forceps, curved on flat, 125mm

- 1 DESCHAMPS needle, blunt, 210mm
- 1 DOYEN Director, curved, 140mm
- 2 Wound retractors, 4 blunt prongs, 160mm
- 2 DESMARRES wound retractors, 135mm
- 1 FINSSEN retractors, 2 x3 blunt prongs, 80mm

- 1 Scalpel handle no. 4
- 4 Sterile scalpel blades, no 18, single peel pack
- 1 Needle box, perforated, round, diam. 65mm
- 1 HEGAR-MAYO DUROGRIP needle holder, 180mm



## Clip Applying Forceps - Suture Set

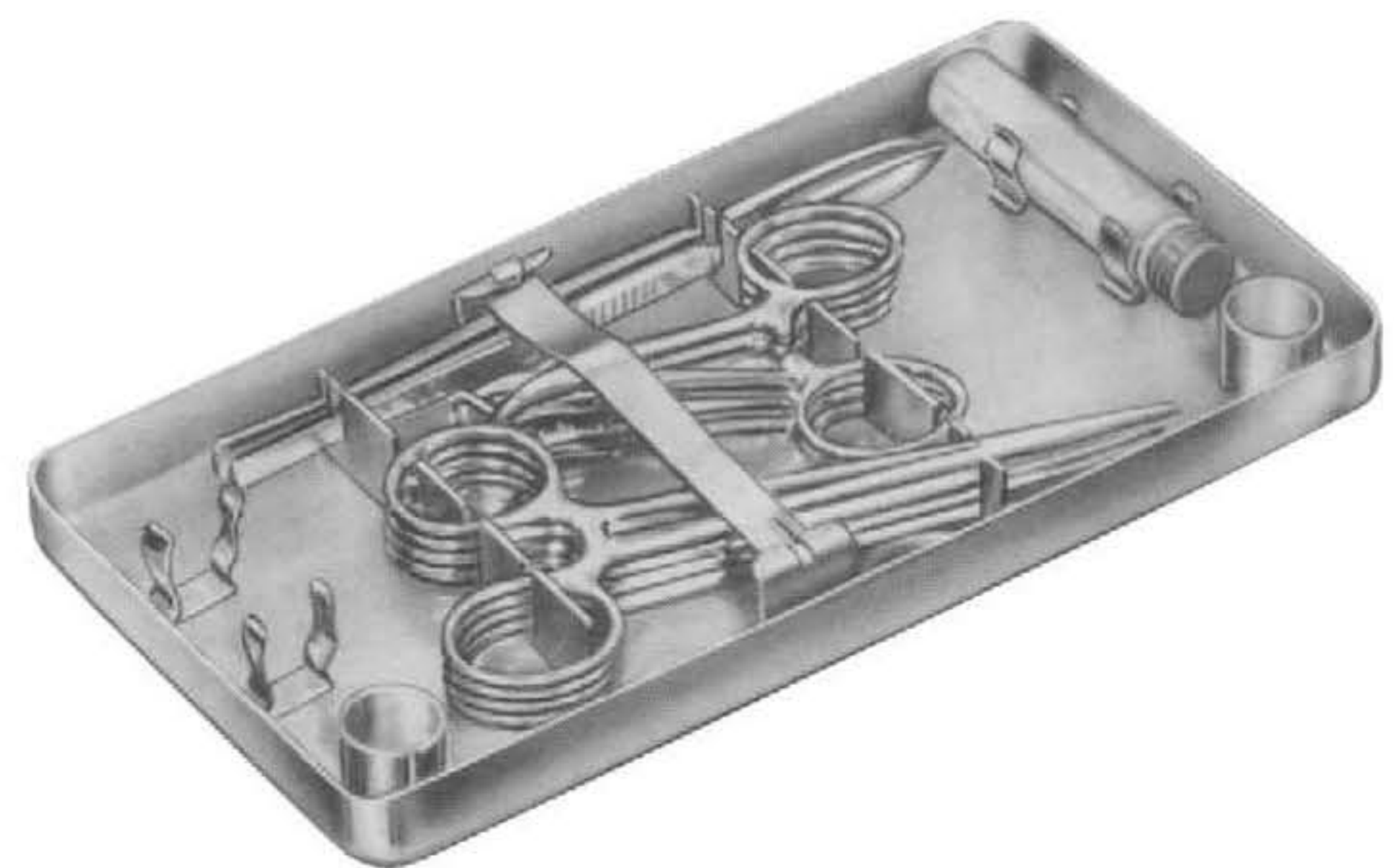
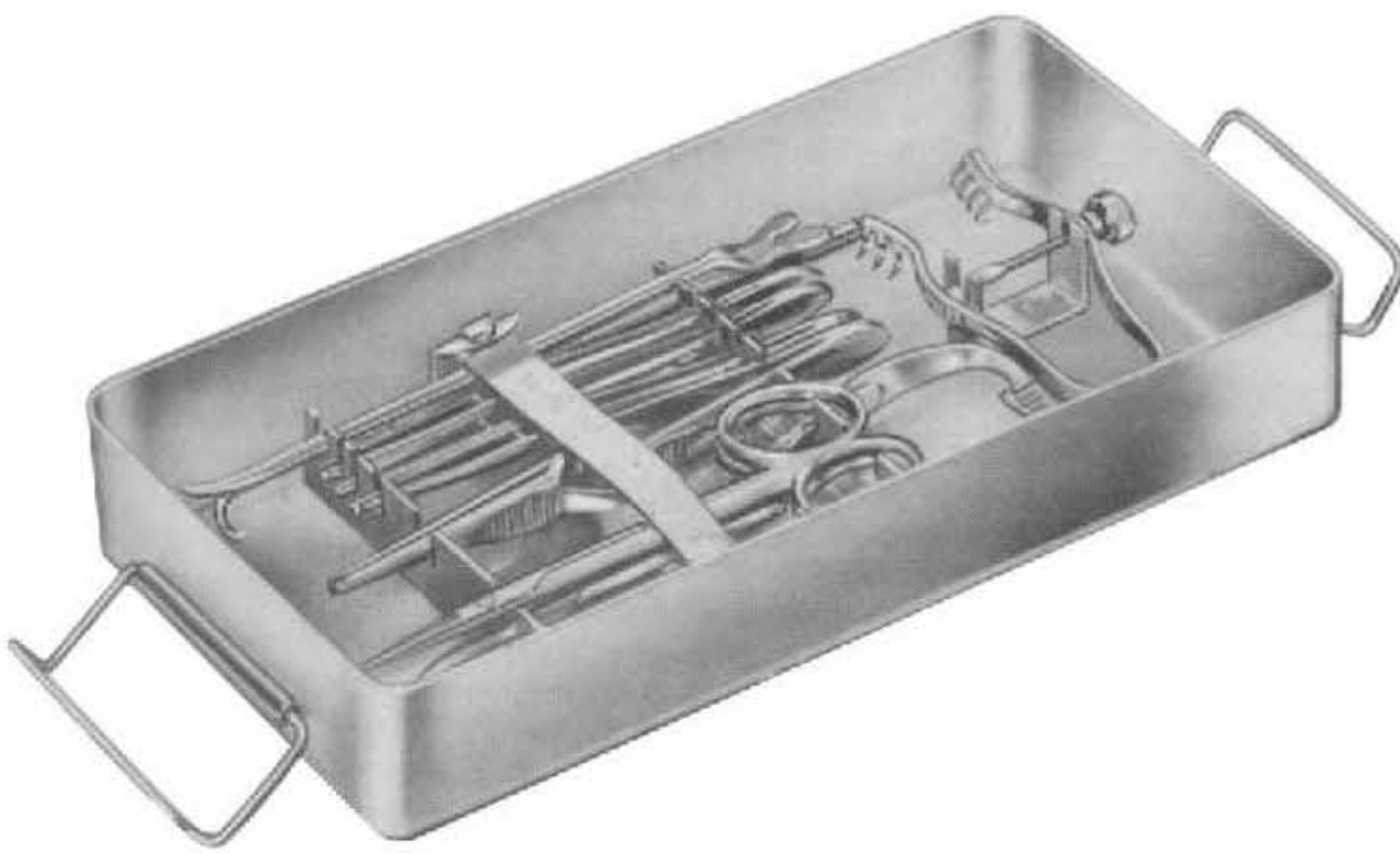

### 07-295

Venae sectio set, in metal case  
consisting of:

#### Bottom tray

- 1 MATHIEU needle holder, fine pattern 140mm
- 1 Ligature needle, fine short pattern
- 1 DOYEN director, curved
- 1 HEGENBARTH clip forceps,
- 1 ELSCHNIG tissue forceps, 1 x 2 teeth fine, 150mm
- 1 Dressing forceps, fine 105mm
- 1 Tissue forceps, 1 x 2 teeth, 110mm
- 1 Vessel scissors, straight, with 1 ball point, 110mm
- 1 Vessel scissors, curved, pointed 105mm
- 1 FINSEN retractor
- 1 Perforated needle case

#### Top tray

- 1 Scalpel, pointed
- 1 Scalpel, bellied
- 2 HALSTED mosquito forceps, curved, 125mm
- 2 HALSTED mosquito forceps, straight, 1x 2 teeth, 125mm
- 3 BACKHAUS towel forceps, 90mm
- 2 Flacon holder



**Nerve - and Vessel Hooks**

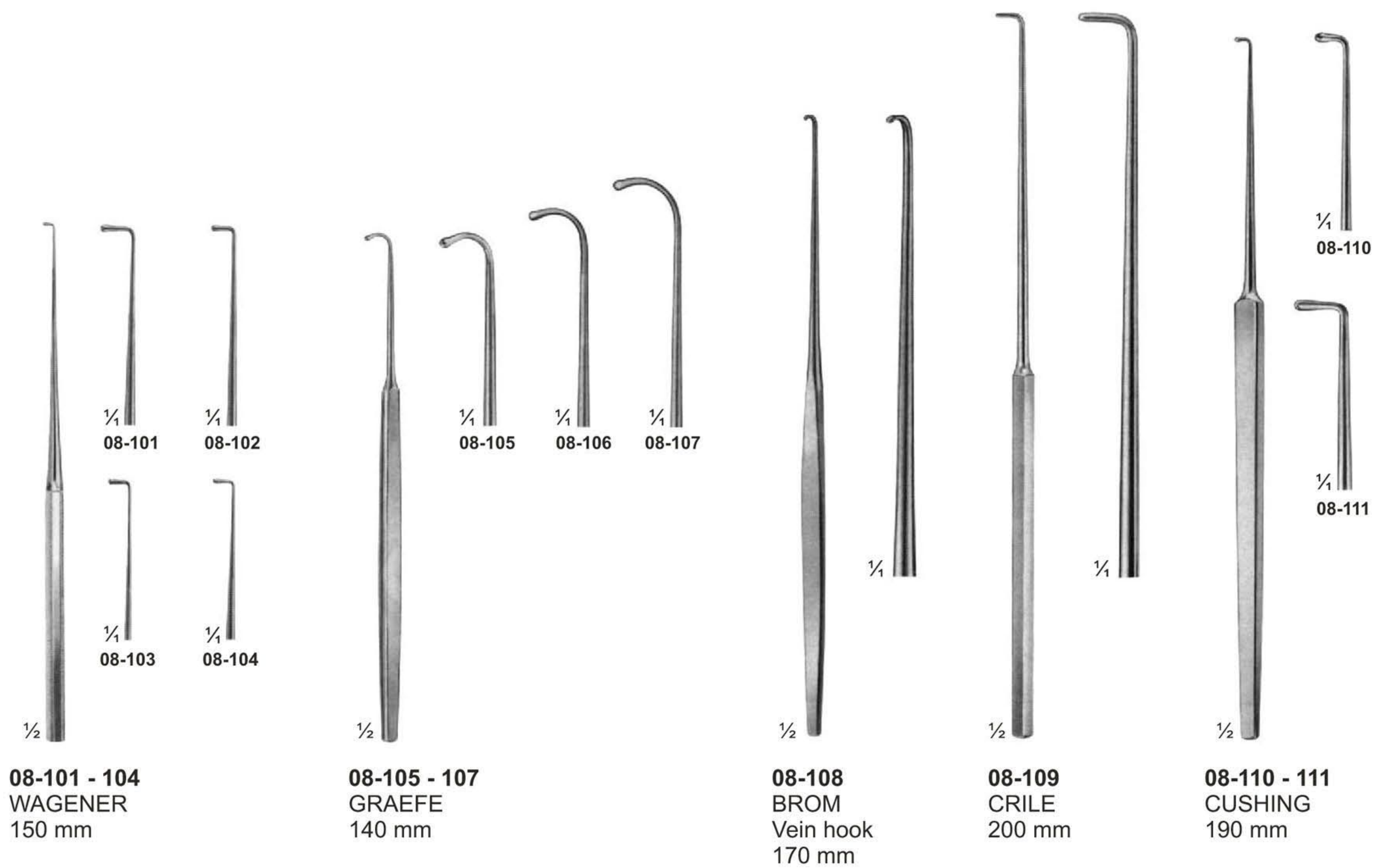



## Nerve - and Vessel Hooks

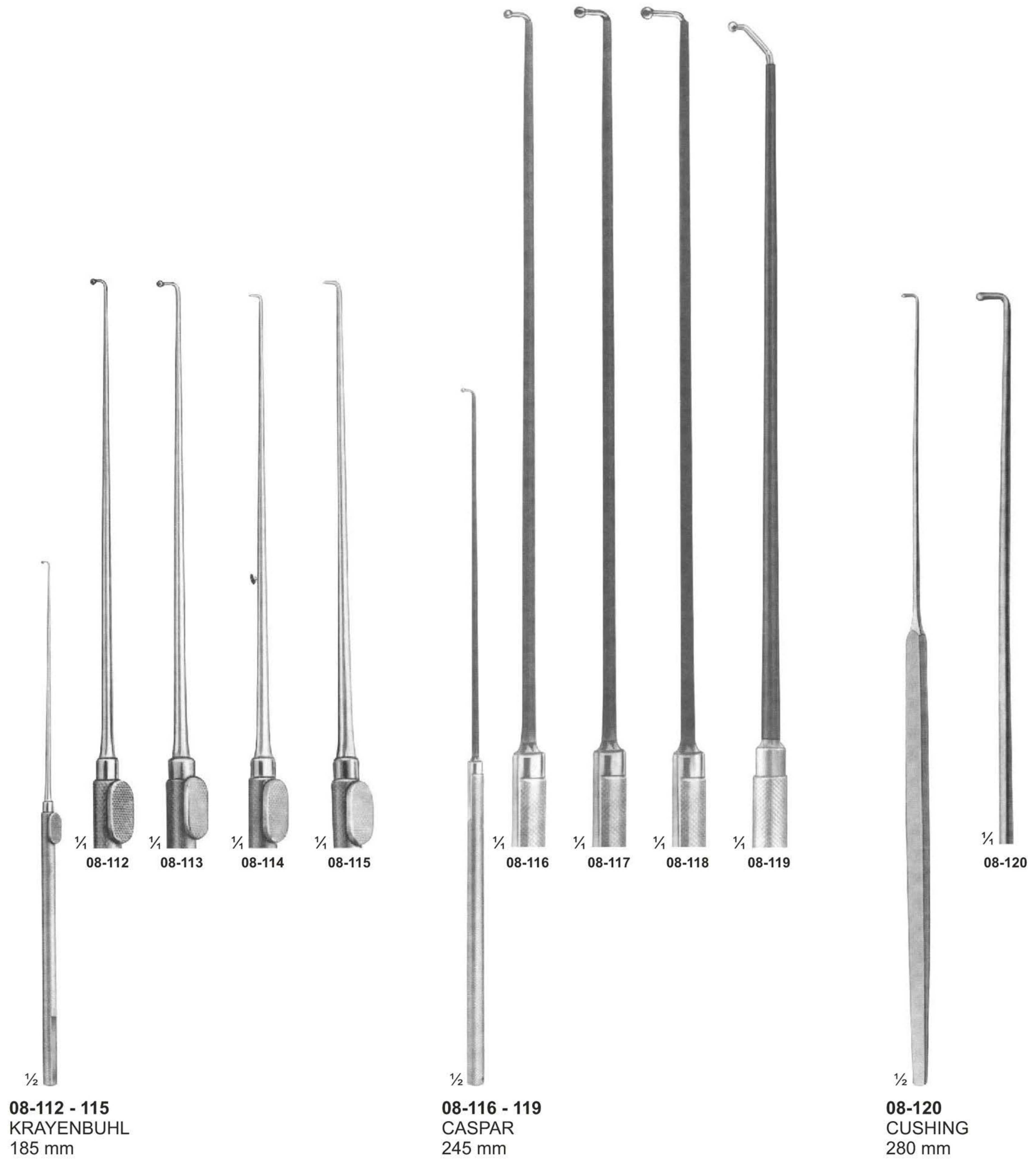



## Fine Wound Retractors (Dura- and Skin Retractors)

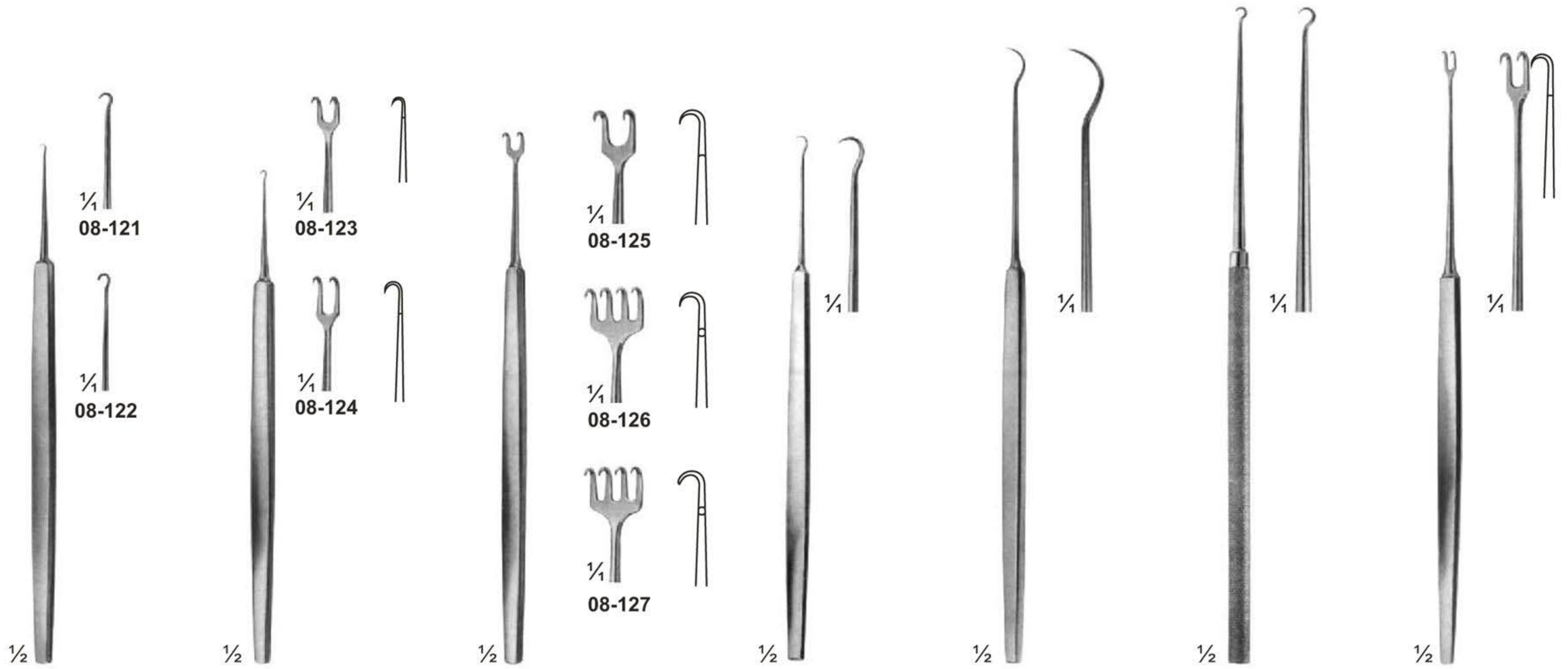

**08-121** Sharp  
**08-122** Blunt  
 GRAEFE  
 125 mm

**08-123** 125 mm  
**08-124** 130 mm  
 Sharp  
 GUTHRIE

**08-125** 130 mm  
**08-126** 135 mm  
 Sharp  
 ROLLET  
**08-127** 135 mm  
 Blunt

**08-128**  
 FRAZIER  
 Dura Retractors  
 130 mm

**08-129**  
 TONNIS  
 Dura Retractors  
 150 mm

**08-130**  
 KILNER  
 160 mm

**08-131**  
 FREER  
 150 mm

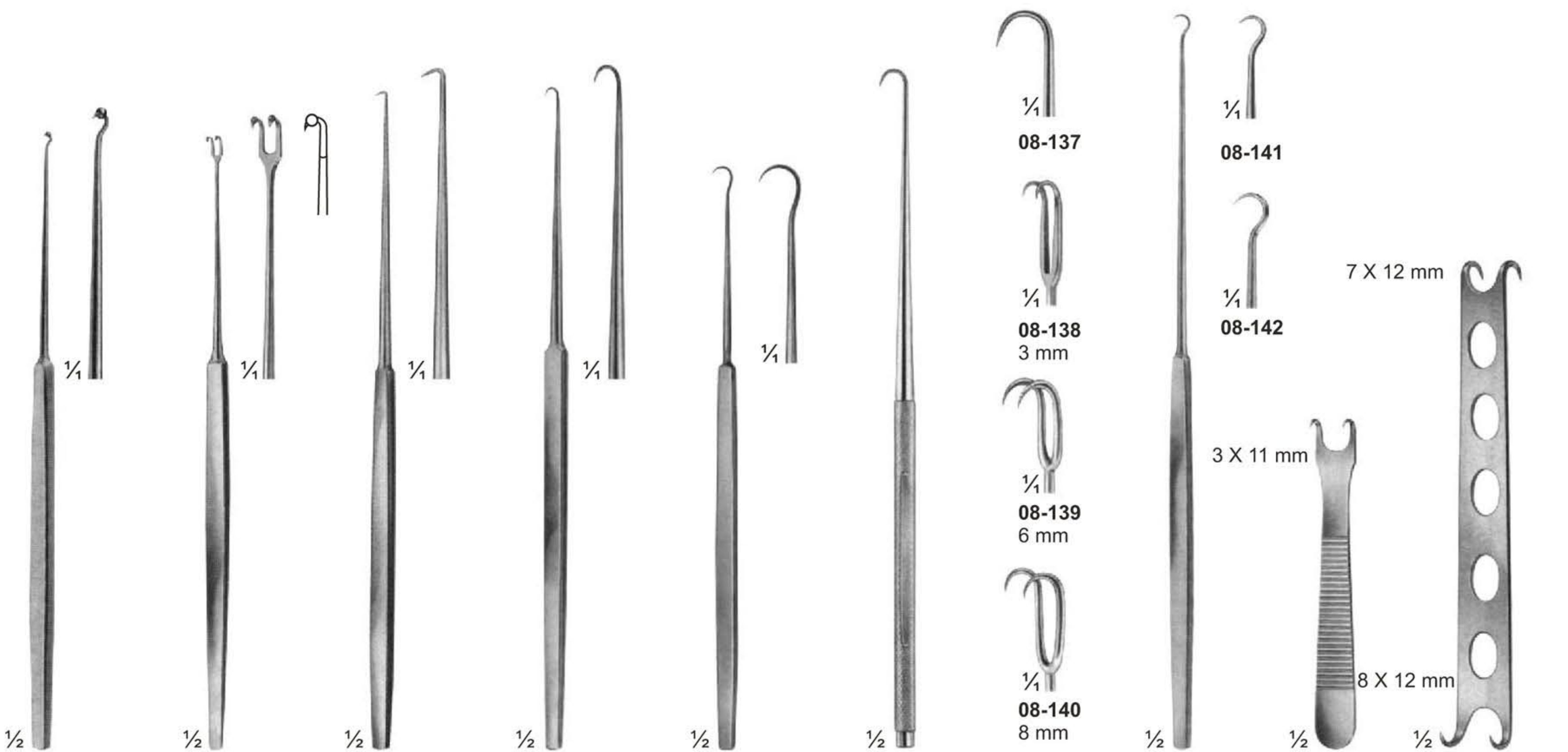

**08-132**  
 MULLER  
 150 mm

**08-133**  
 MULLER  
 150 mm

**08-134**  
 COTTLE  
 160 mm

**08-135**  
 COTTLE  
 160 mm

**08-136**  
 JAEGAR  
 135 mm

**08-137 - 140**  
 JOSEPH  
 165 mm

**08-141 - 142**  
 GILLIES  
 180 mm

**08-143**  
 KILNER  
 Sharp  
 80 mm

**08-144**  
 CONVERSE  
 Blunt  
 120 mm



# Wound - Trachea Retractors

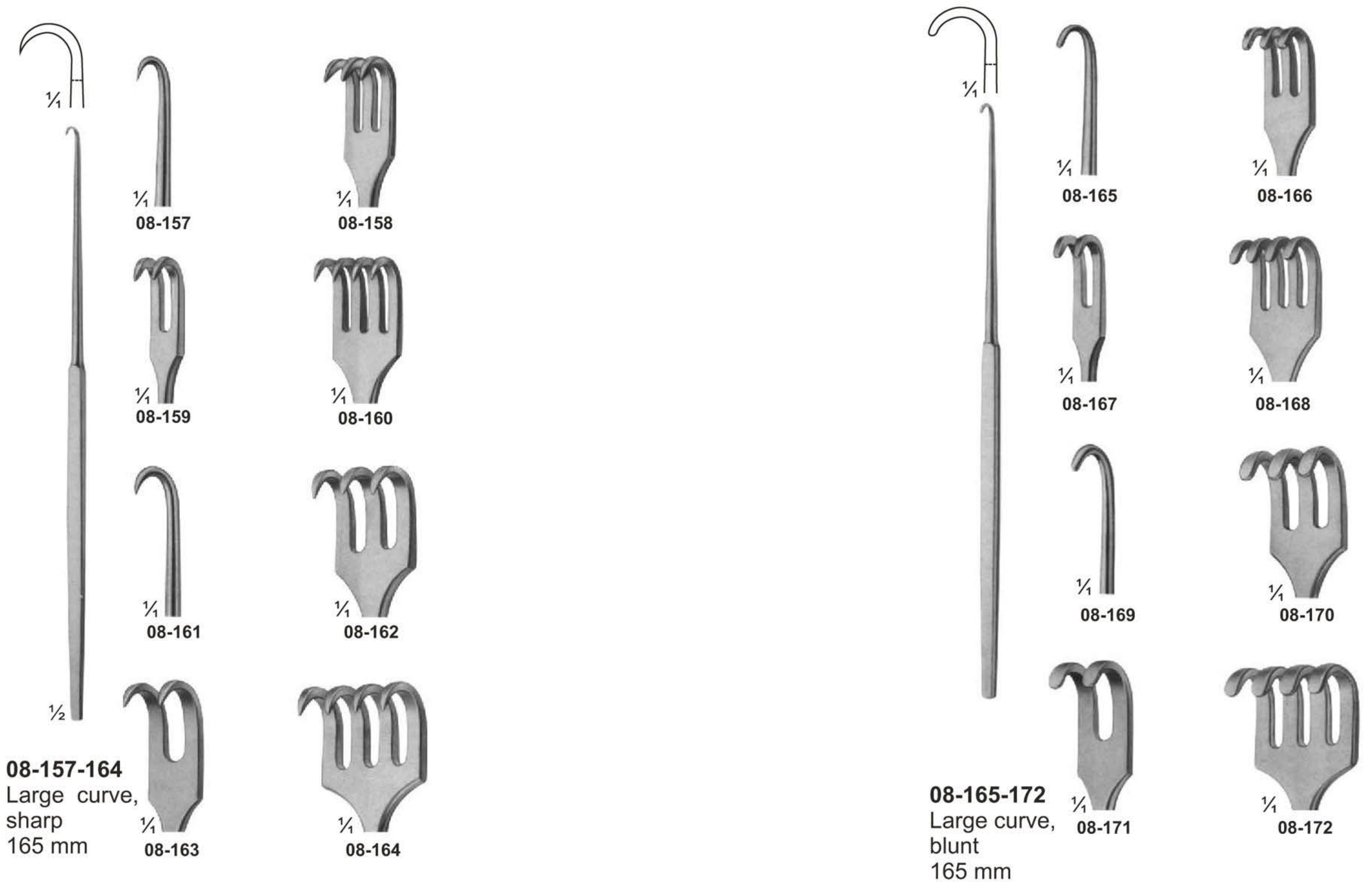
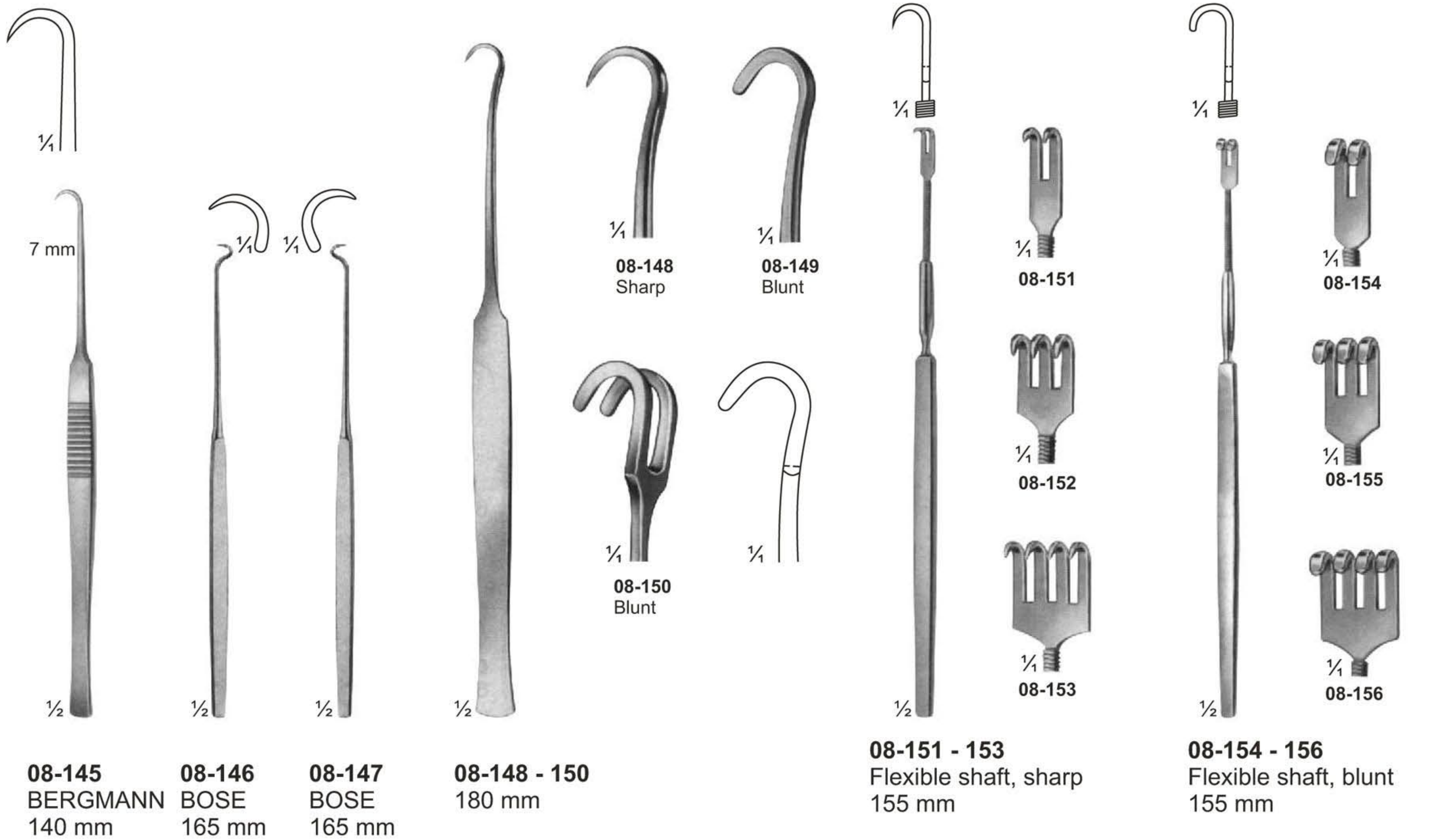



## Retractors With Treangle Handle

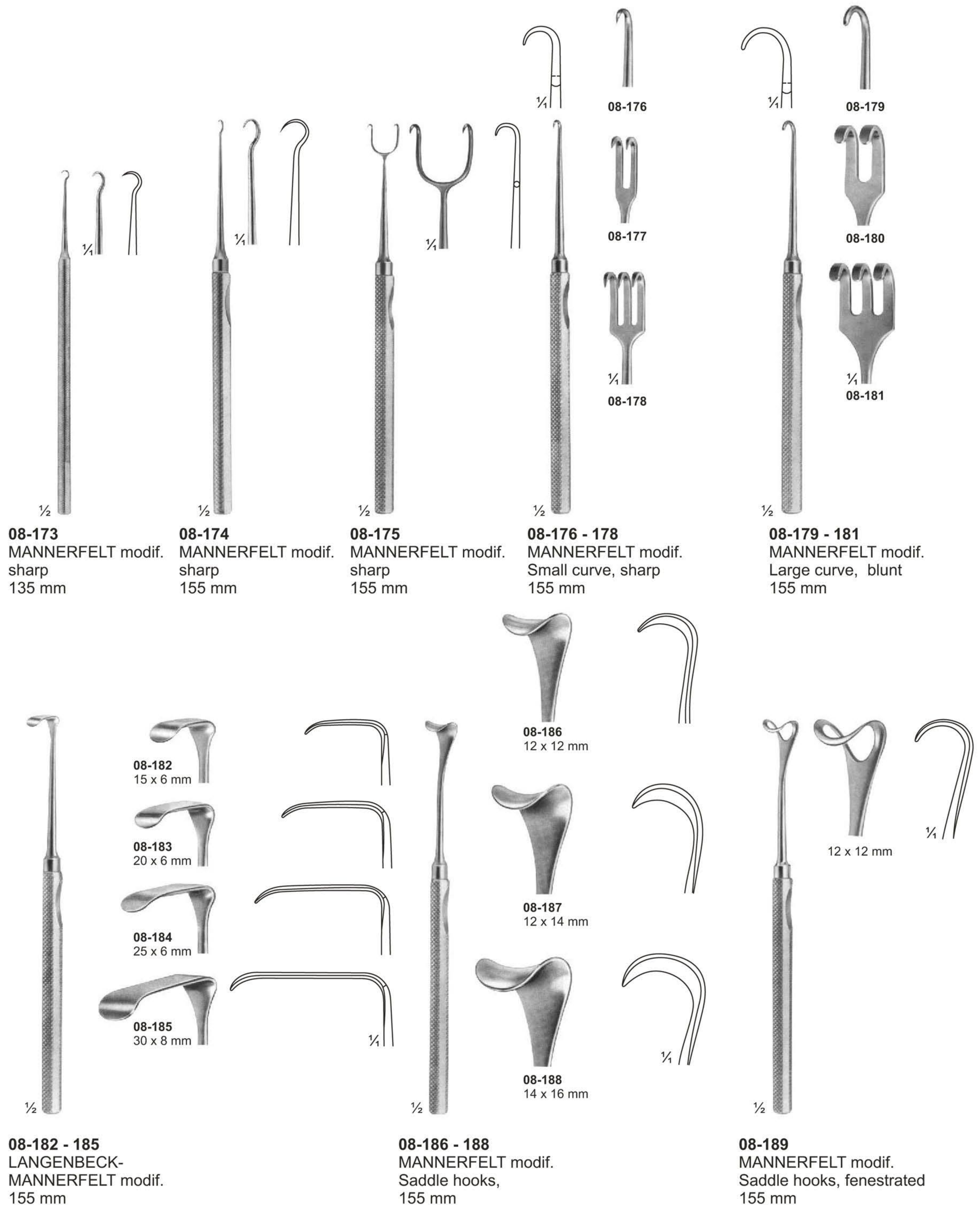



**Retractors**

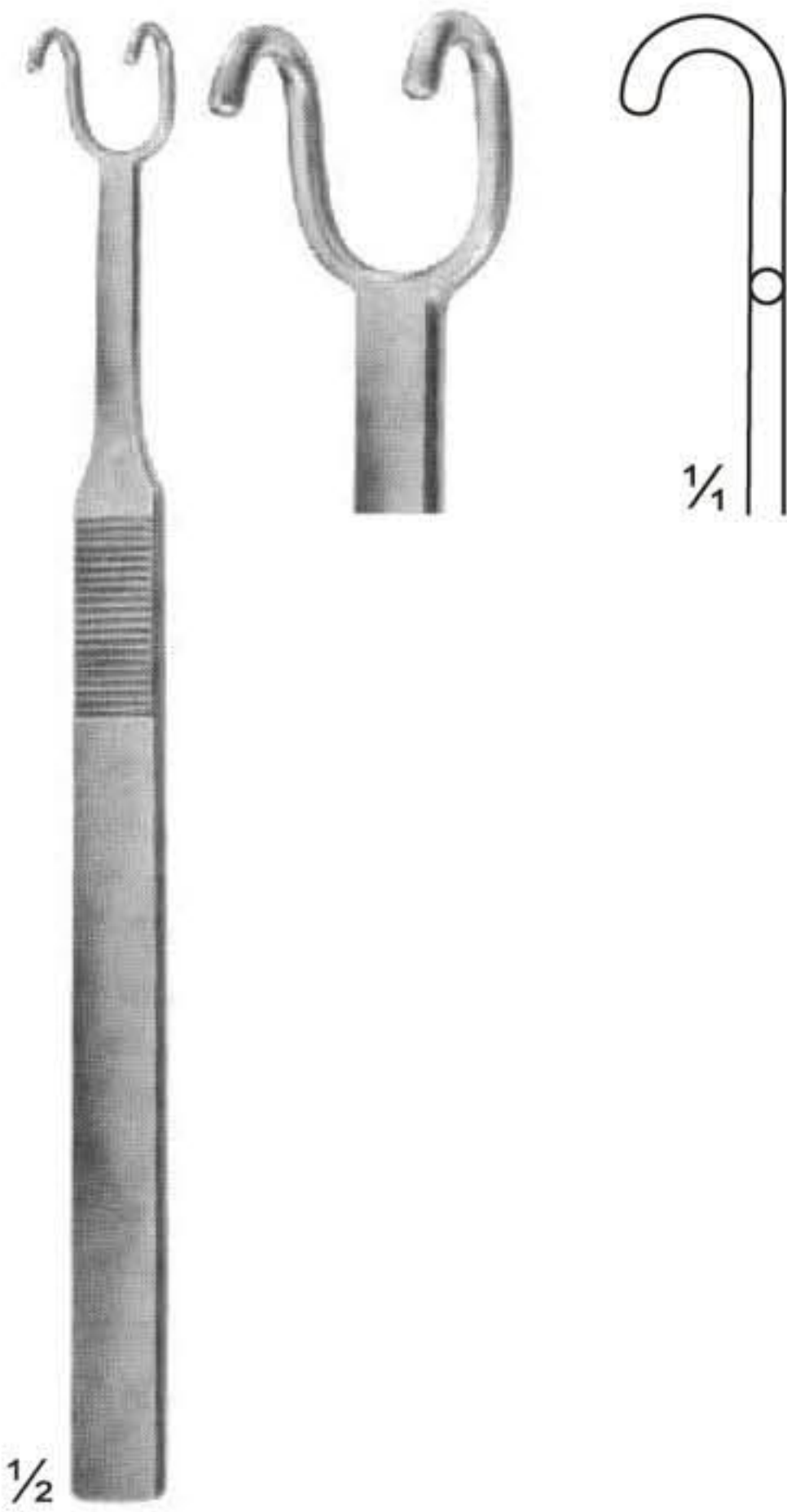

**08-190**  
FOMON  
145 mm

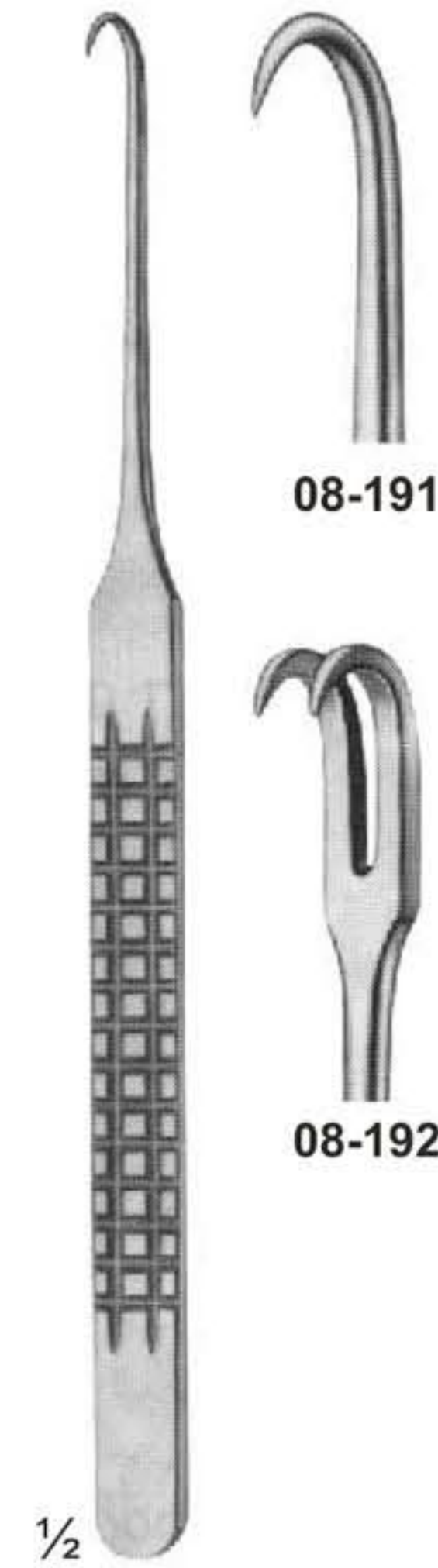

**08-191 - 192**  
160 mm



**08-193 - 194**  
LANGENBECK-GREEN  
160 mm

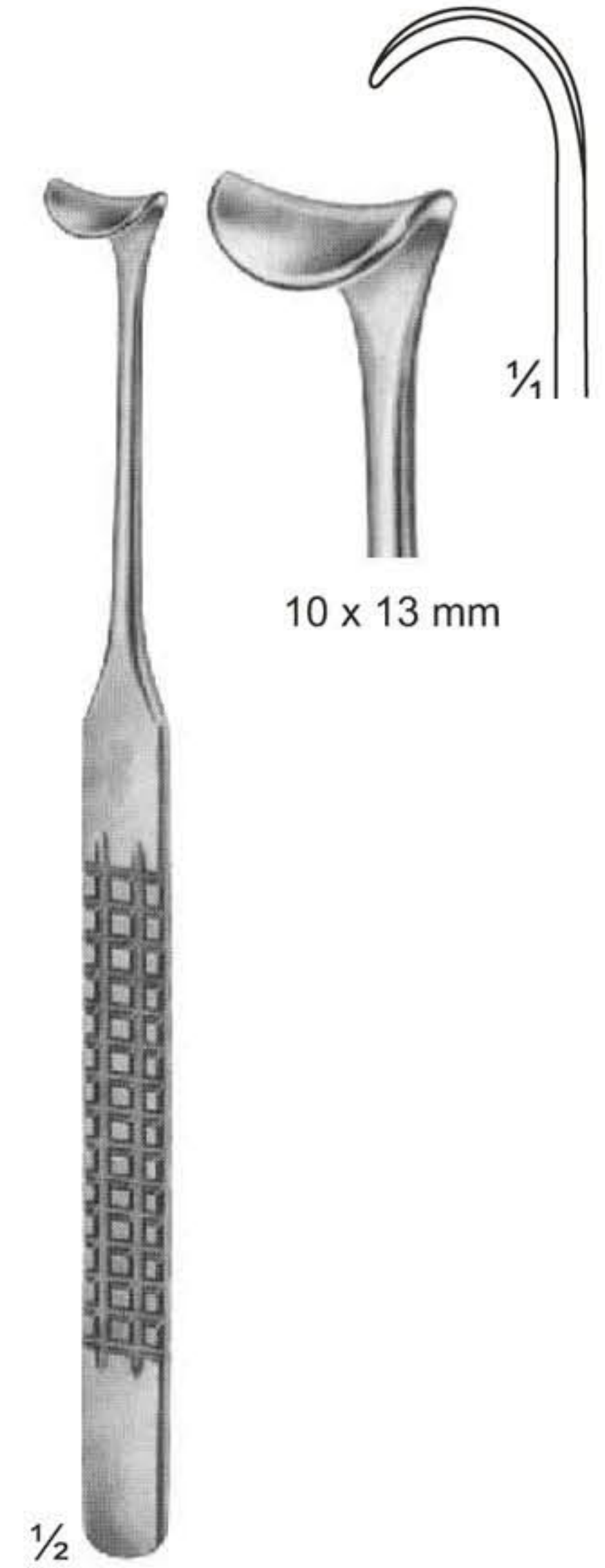

**08-195**  
160 mm



**08-196 - 201**  
MEYERDING  
Fig. A - Fig. F  
180 mm



**08-196**  
18 x 7 mm

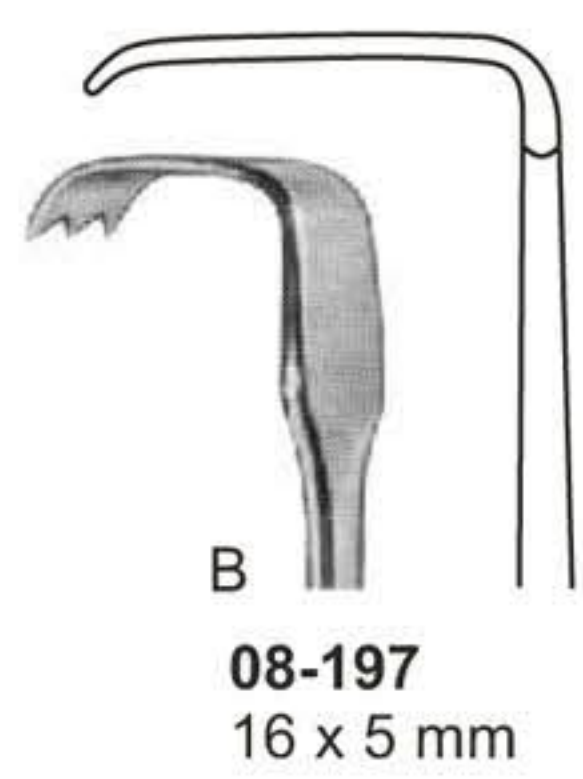

**08-197**  
16 x 5 mm

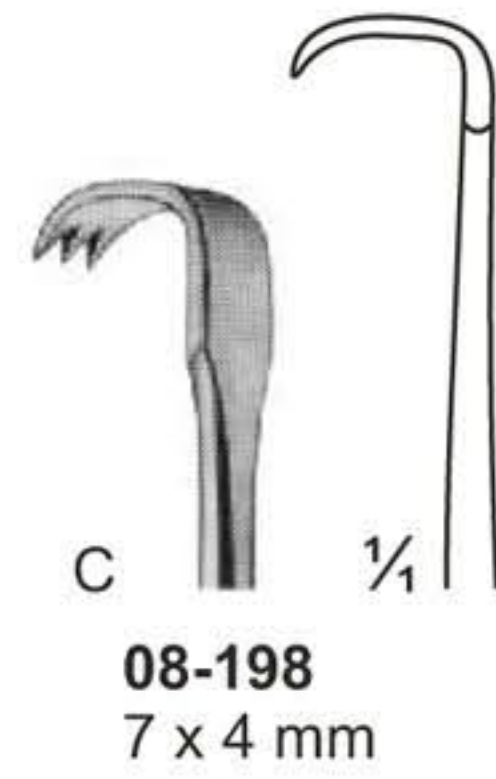

**08-198**  
7 x 4 mm

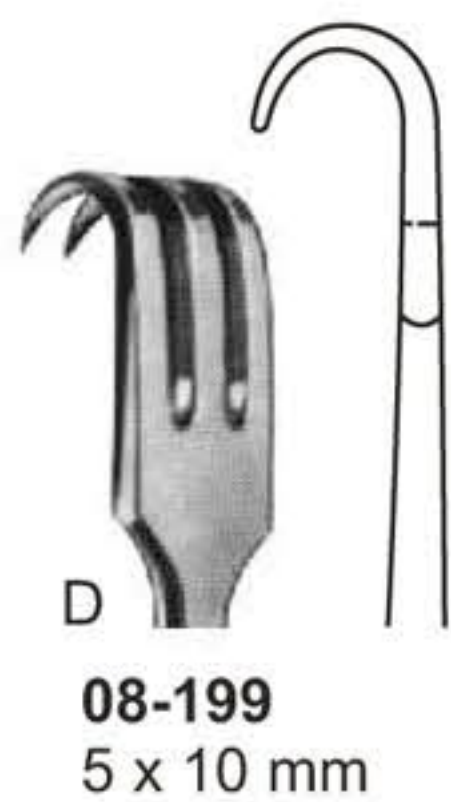

**08-199**  
5 x 10 mm



**08-200**  
11 x 4 mm

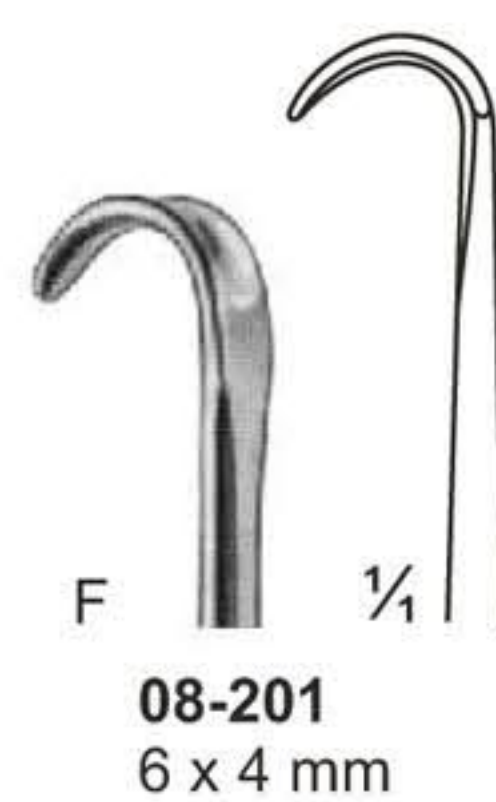

**08-201**  
6 x 4 mm

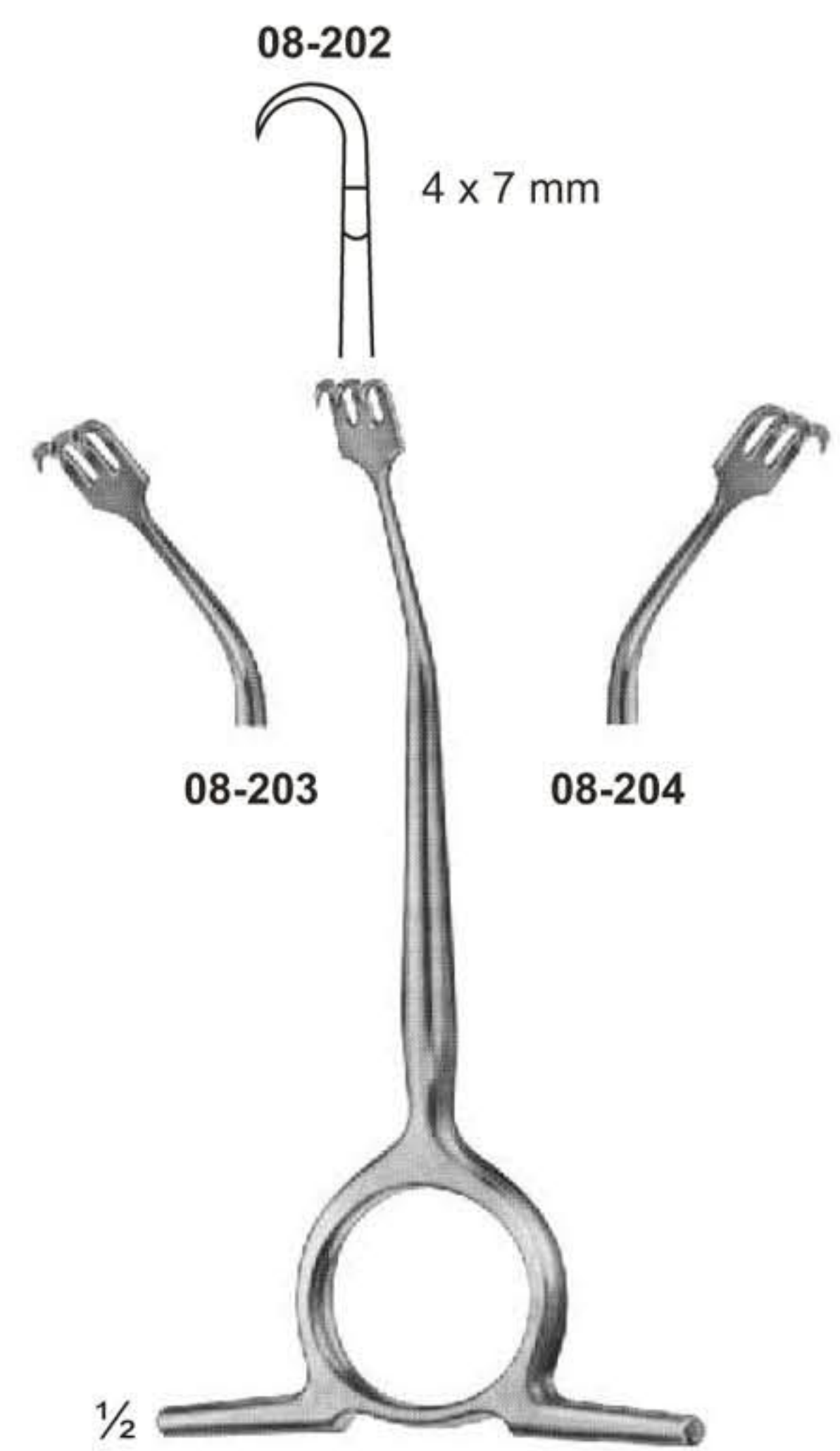

**08-202**  
4 x 7 mm

**08-203**

**08-204**

**08-202 - 204**  
WILLIGER  
120 mm



# Retractors



**08-205**  
EMMET  
Fistula hook  
220 mm

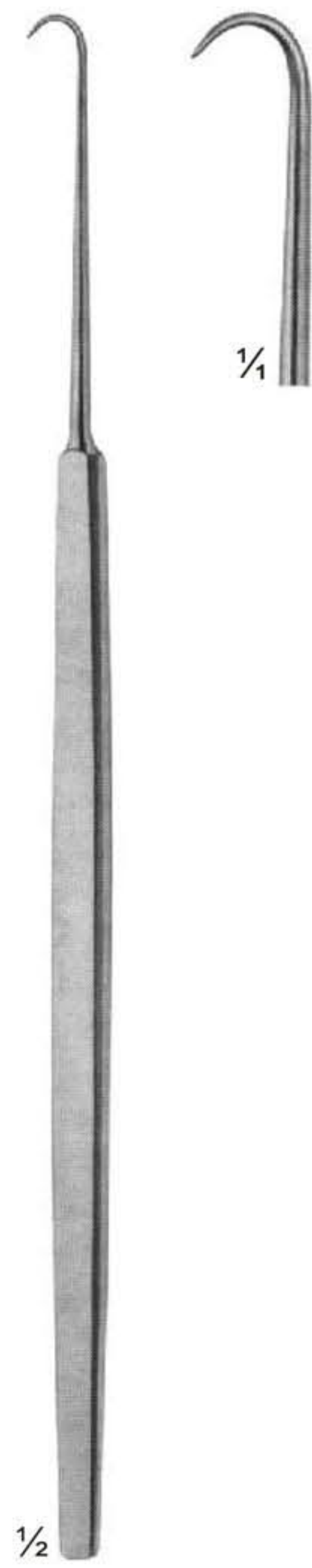

**08-206**  
SIMON  
Fistula hook  
220 mm

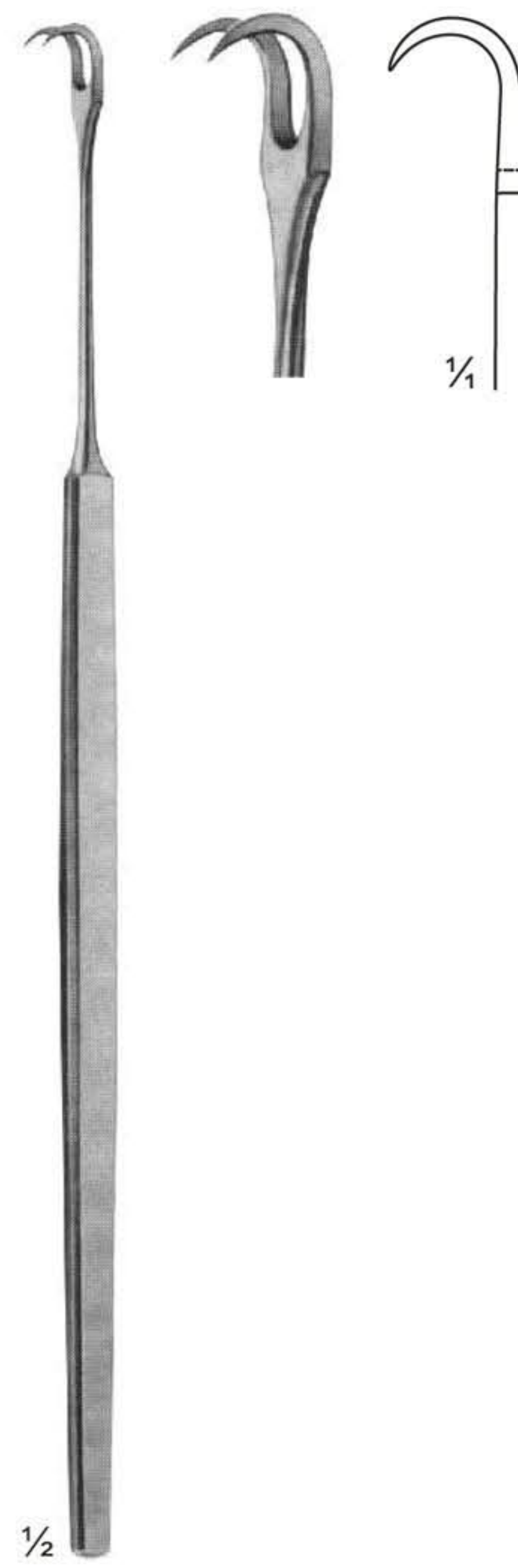

**08-207**  
SIMON  
Fistula hook  
220 mm

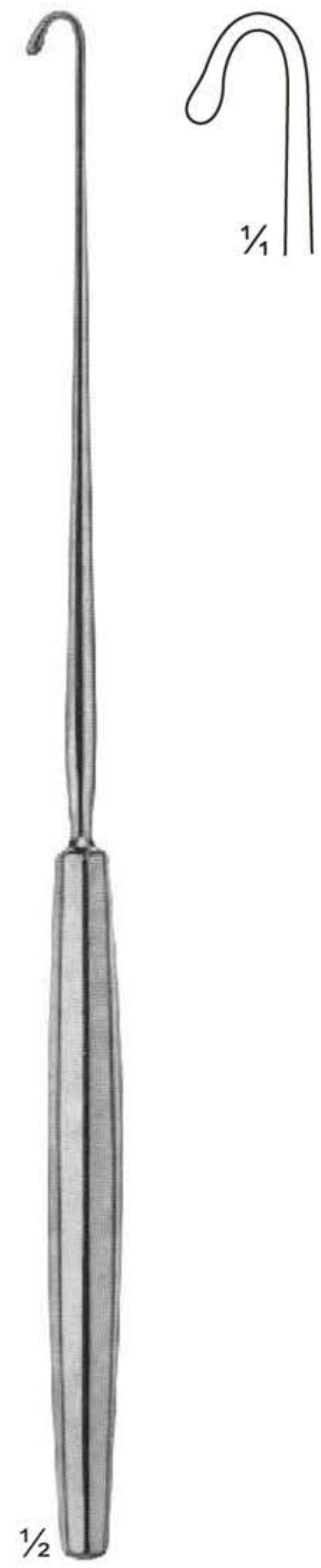

**08-208**  
LANGE  
Fistula hook  
230 mm

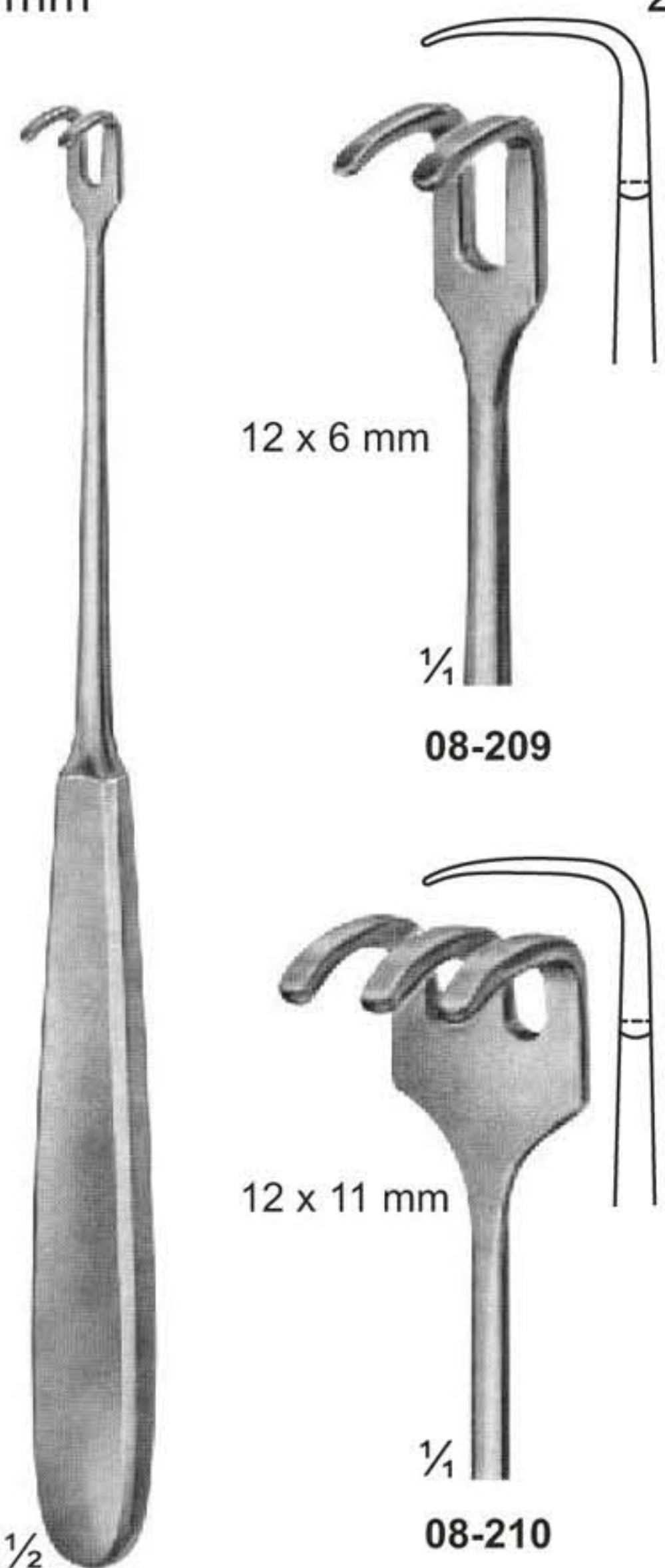

**08-209 - 210**  
Tendon hooks  
175 mm

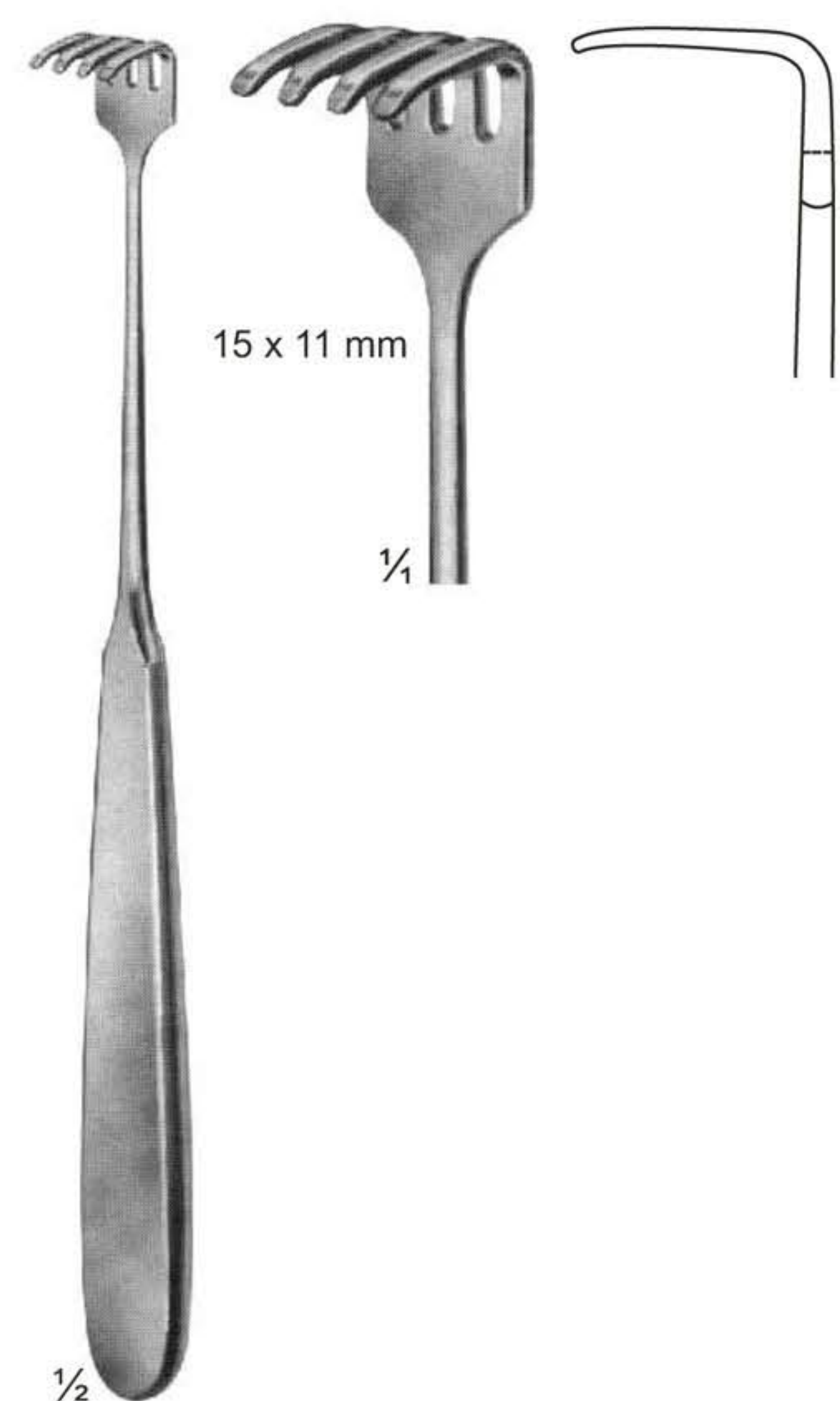

**08-211**  
KLAPP  
Tendon hooks  
175 mm



**Retractors**

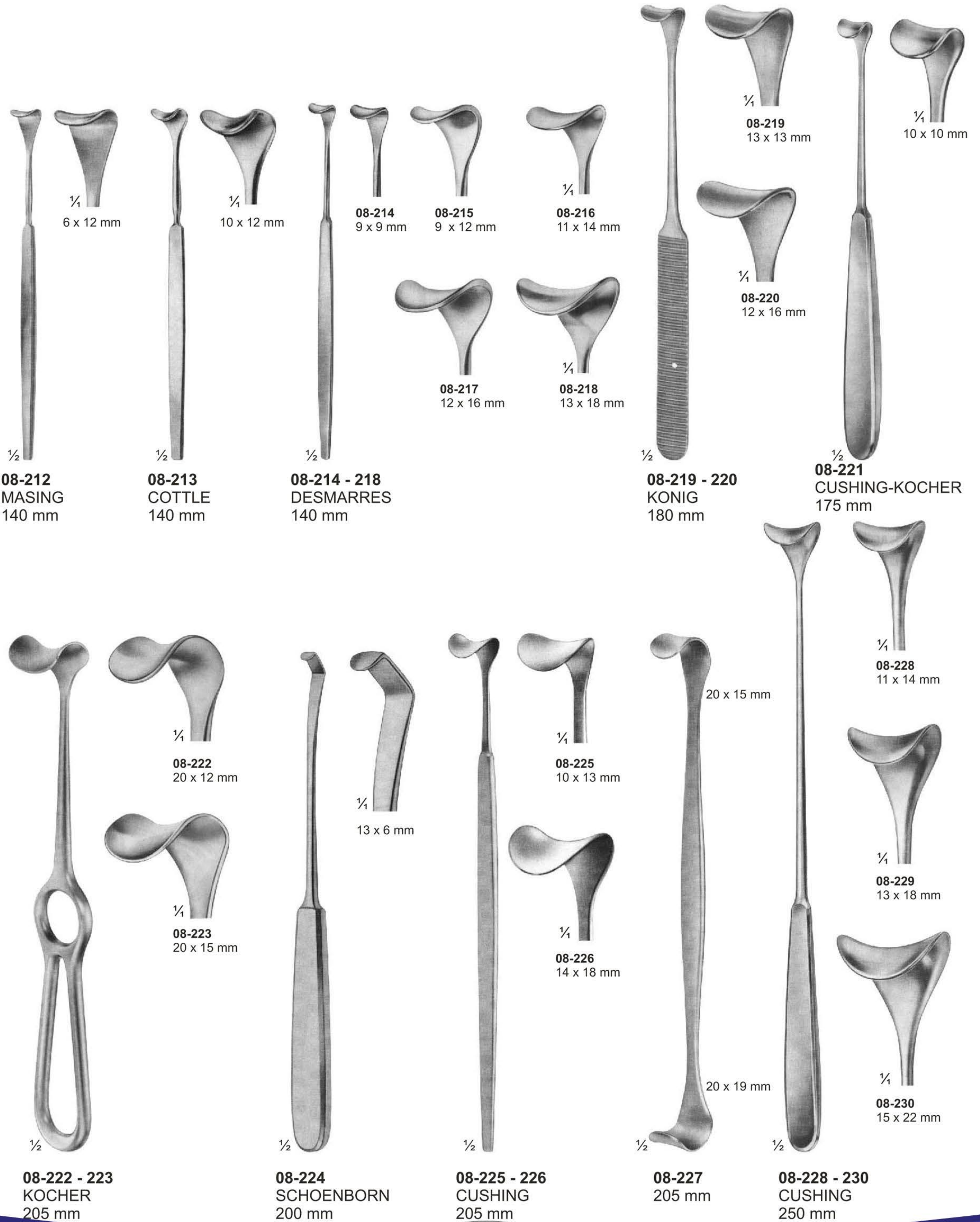



**Retractors**

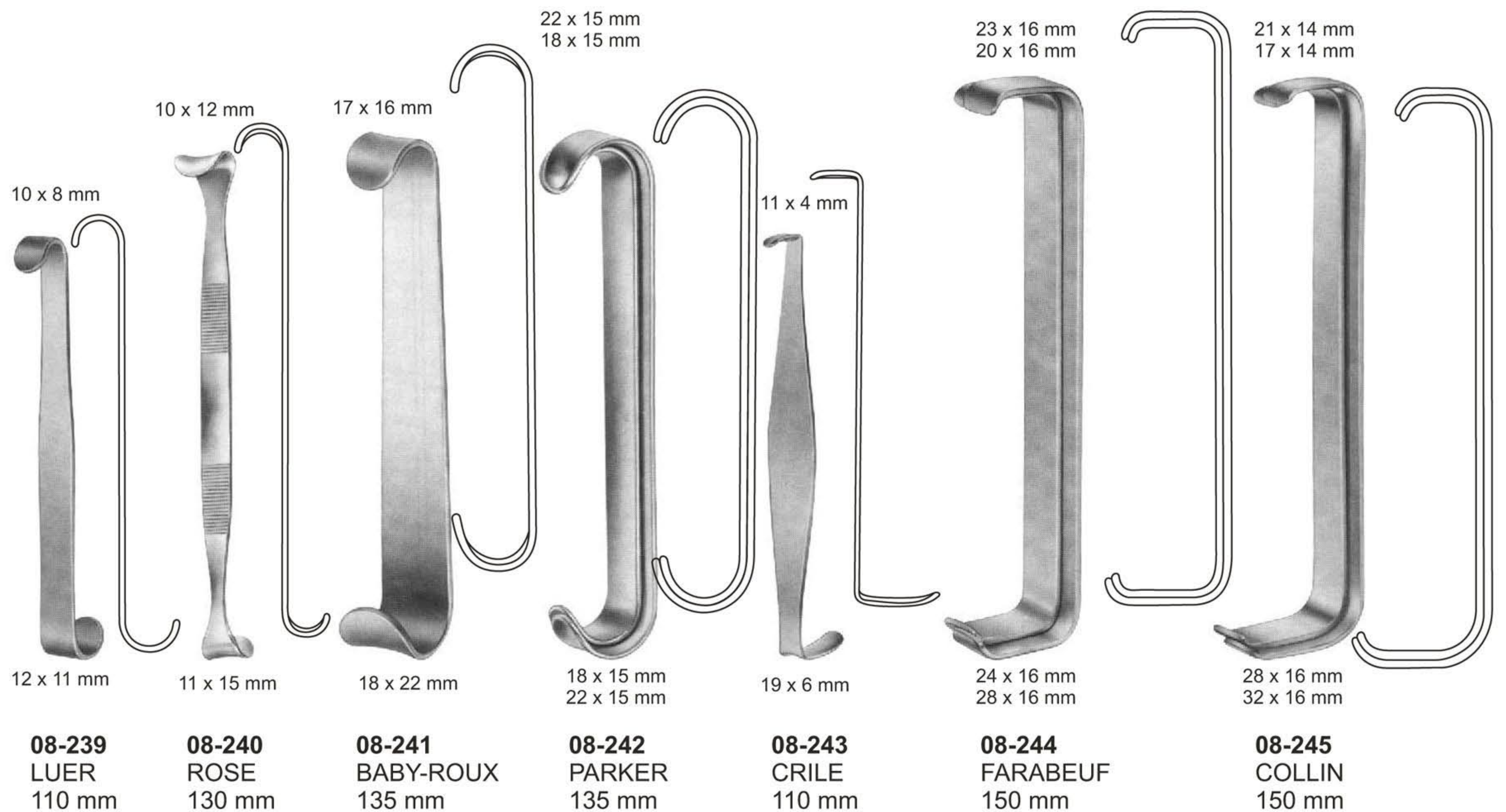



**Retractors**

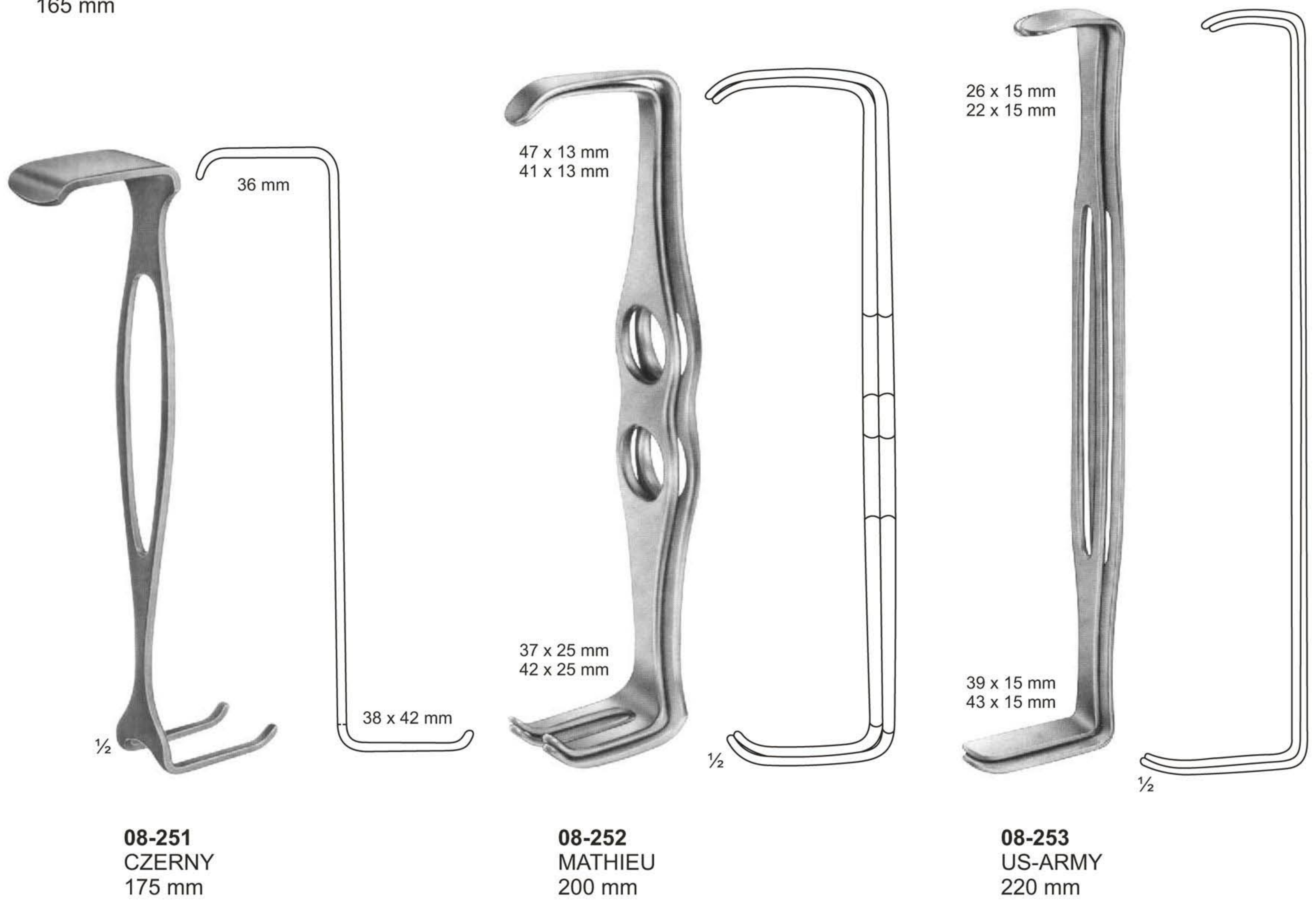
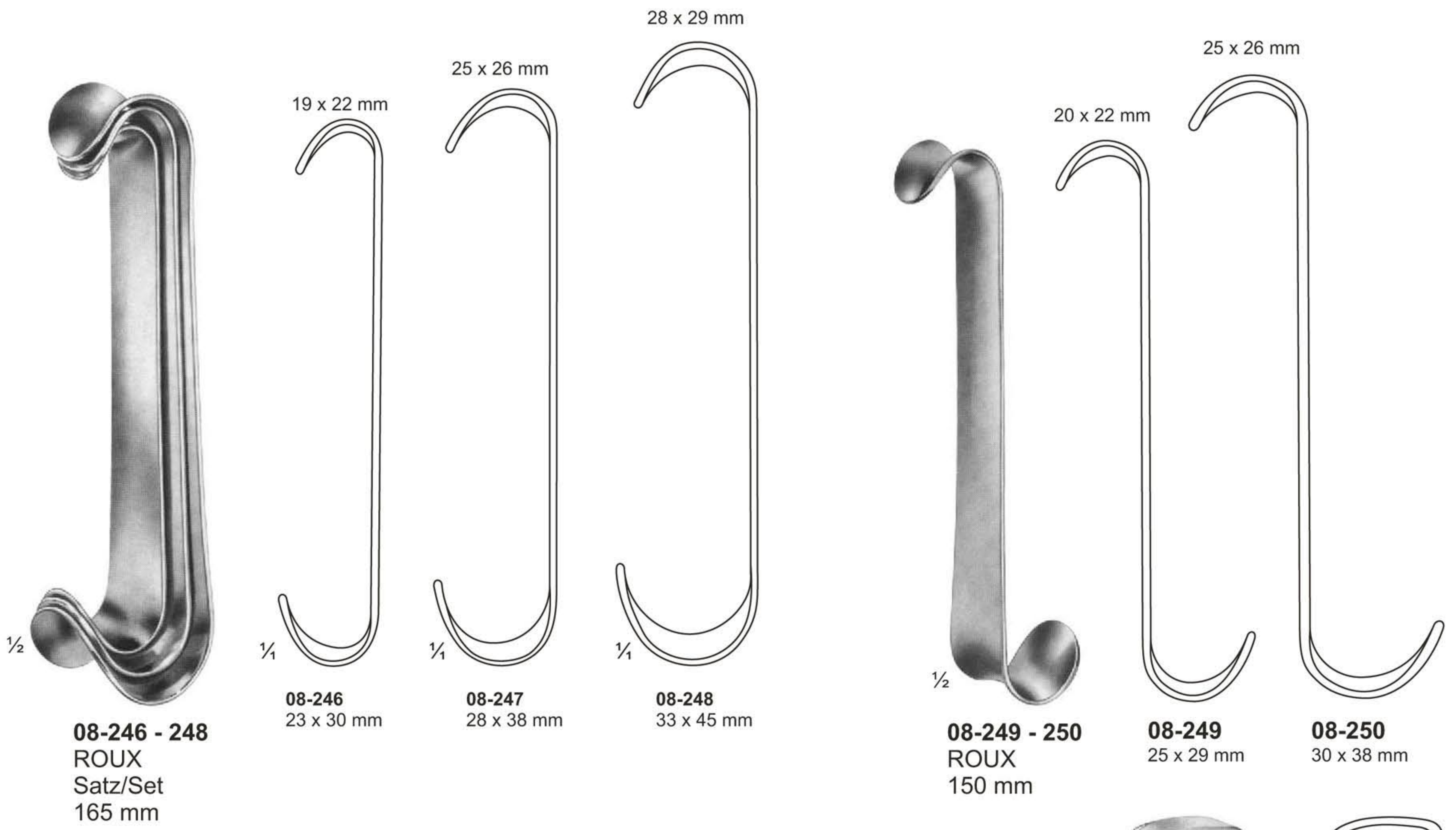



**Bone Retractors and Retractors**



**08-254**  
KOCHER  
Sharp  
205 mm



**08-255**  
KOCHER  
Sharp  
220 mm



**08-256**  
KOCHER  
Blunt  
220 mm



**08-257**  
VOLKMANN  
Sharp  
220 mm

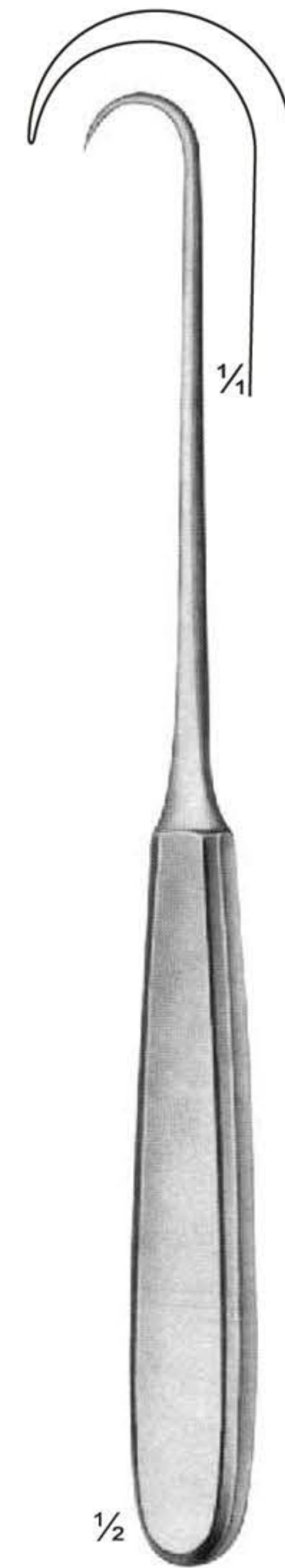

**08-258**  
VOLKMANN  
Sharp  
220 mm



**08-259 - 266**  
VOLKMANN  
225 mm

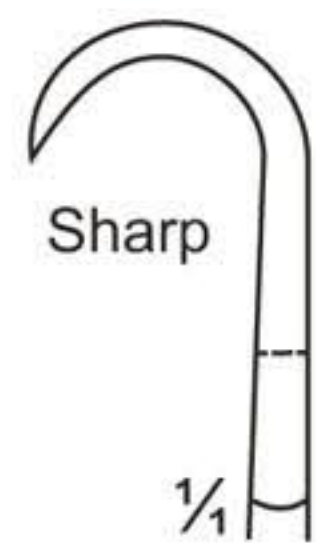

Sharp

1/4

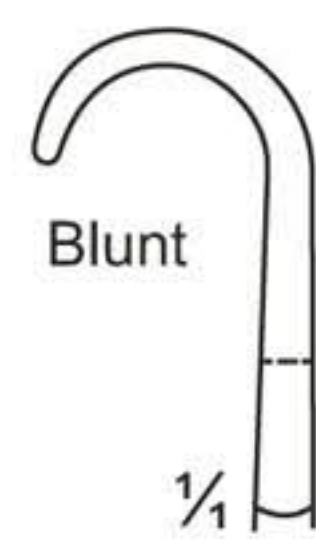

Blunt

1/4



**08-259**  
9 x 8 mm



**08-260**  
9 x 13 mm



**08-261**  
9 x 19 mm



**08-262**  
9 x 29 mm



**08-263**  
8,5 x 8 mm



**08-264**  
8,5 x 13 mm



**08-265**  
8,5 x 19 mm

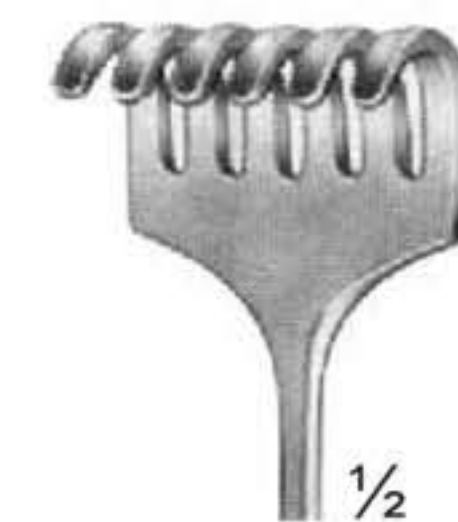

**08-266**  
8,5 x 29 mm



# Retractors

















**08-267 - 280**  
VOLKMANN  
220 mm

1/2

Sharp  
1/4

Blunt  
1/4

Semi-Sharp  
1/4

				
<b>08-267</b> 9 x 8 mm	<b>08-268</b> 9 x 13 mm	<b>08-269</b> 9 x 19 mm	<b>08-270</b> 9 x 29 mm	<b>08-271</b> 9 x 40 mm
				
<b>08-272</b> 8 x 8 mm	<b>08-273</b> 8 x 13 mm	<b>08-274</b> 8 x 19 mm	<b>08-275</b> 8 x 29 mm	<b>08-276</b> 8 x 40 mm
				
<b>08-277</b> 8,5 x 8 mm	<b>08-278</b> 8,5 x 13 mm	<b>08-279</b> 8,5 x 19 mm	<b>08-280</b> 8,5 x 29 mm	









**08-281 - 288**  
KOCHER  
220 mm

1/2

Semi-Sharp  
1/4

Blunt  
1/4

			
<b>08-281</b> 16 x 9 mm	<b>08-282</b> 16 x 14 mm	<b>08-283</b> 16 x 20 mm	<b>08-284</b> 16 x 30 mm
			
<b>08-285</b> 15,5 x 9 mm	<b>08-286</b> 15,5 x 14 mm	<b>08-287</b> 15,5 x 20 mm	<b>08-288</b> 15,5 x 30 mm



**Retractors, Deep form**

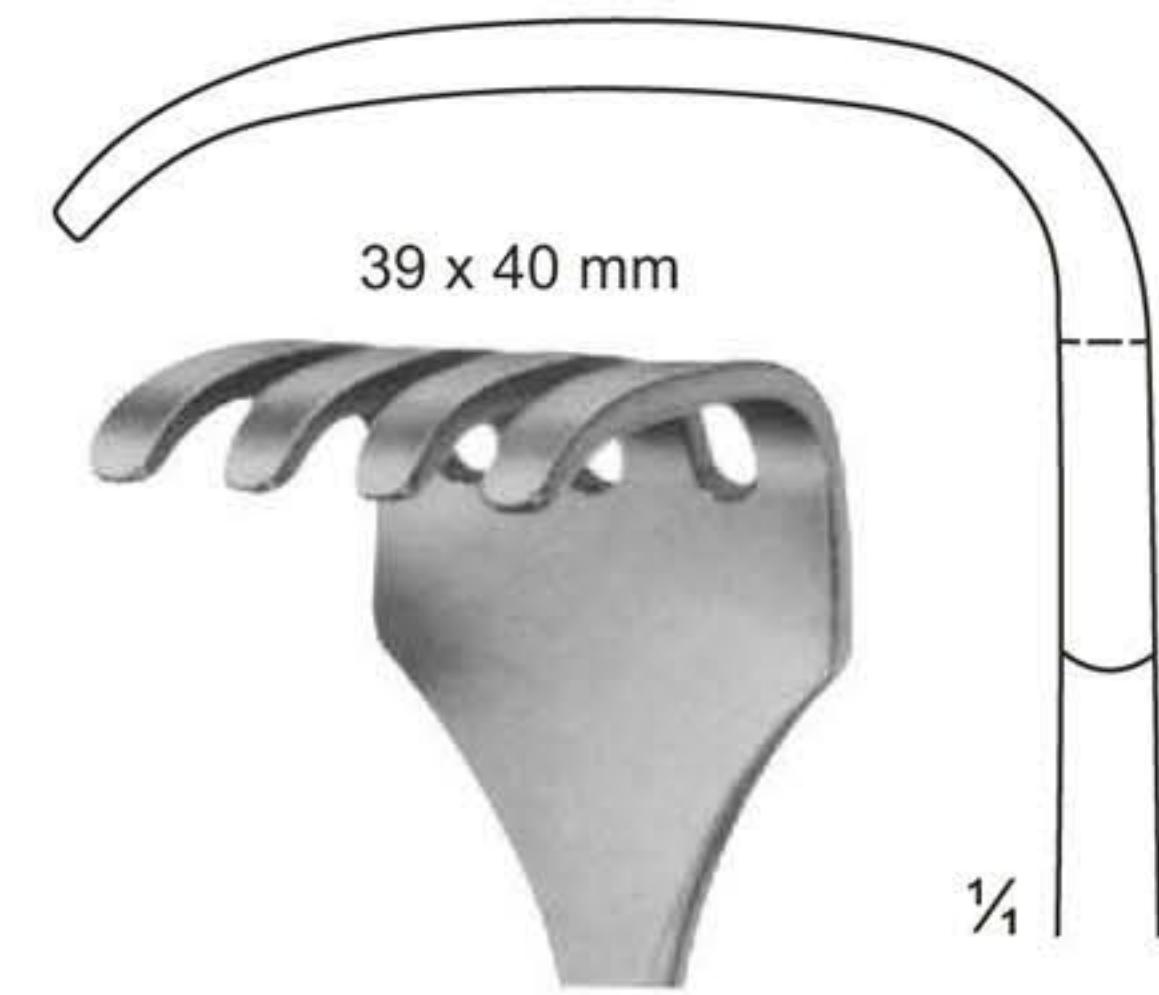

**08-291**  
4 Prongs, blunt

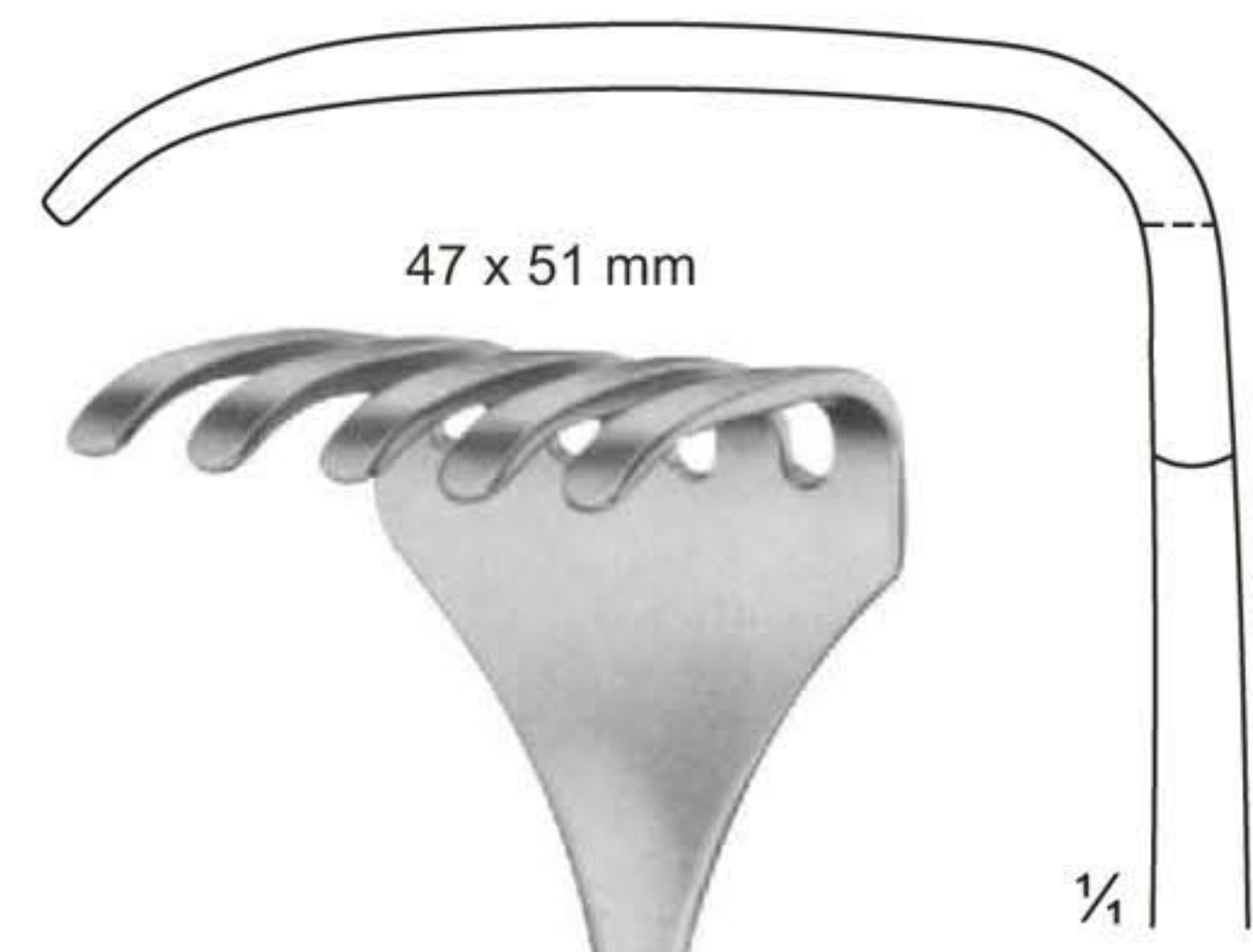

**08-292**  
5 Prongs, blunt



**08-293**  
6 Prongs, blunt

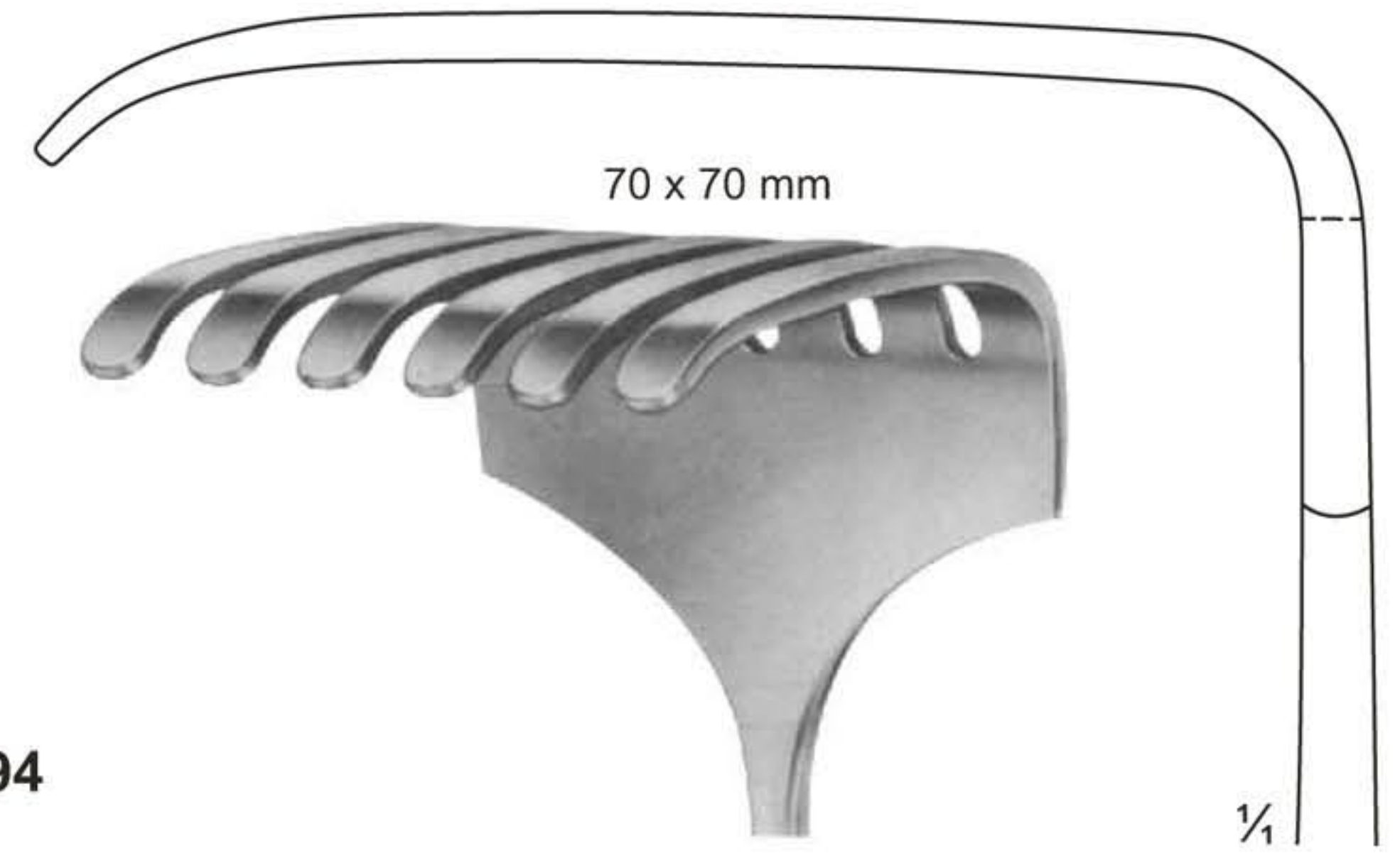

**08-294**  
6 Prongs, blunt



**08-289 - 290**  
KORTE  
240 mm



**08-289**  
8 Prongs, blunt



**08-290**  
8 Prongs, sharp



**08-291 - 294**  
ISRAEL  
255 mm



Retractors



**08-295 - 300**  
LANGENBECK  
210 mm  
**08-295** 28 x 10 mm  
**08-296** 28 x 14 mm  
**08-297** 33 x 14 mm  
**08-298** 28 x 16 mm  
**08-299** 40 x 10 mm  
**08-300** 40 x 13 mm



**08-301 - 307**  
KOCHER-LANGENBECK  
215 mm  
**08-301** 25 x 6 mm  
**08-302** 35 x 8 mm  
**08-303** 35 x 11 mm  
**08-304** 35 x 15 mm  
**08-305** 41 x 11 mm  
**08-306** 55 x 11 mm  
**08-307** 70 x 14 mm

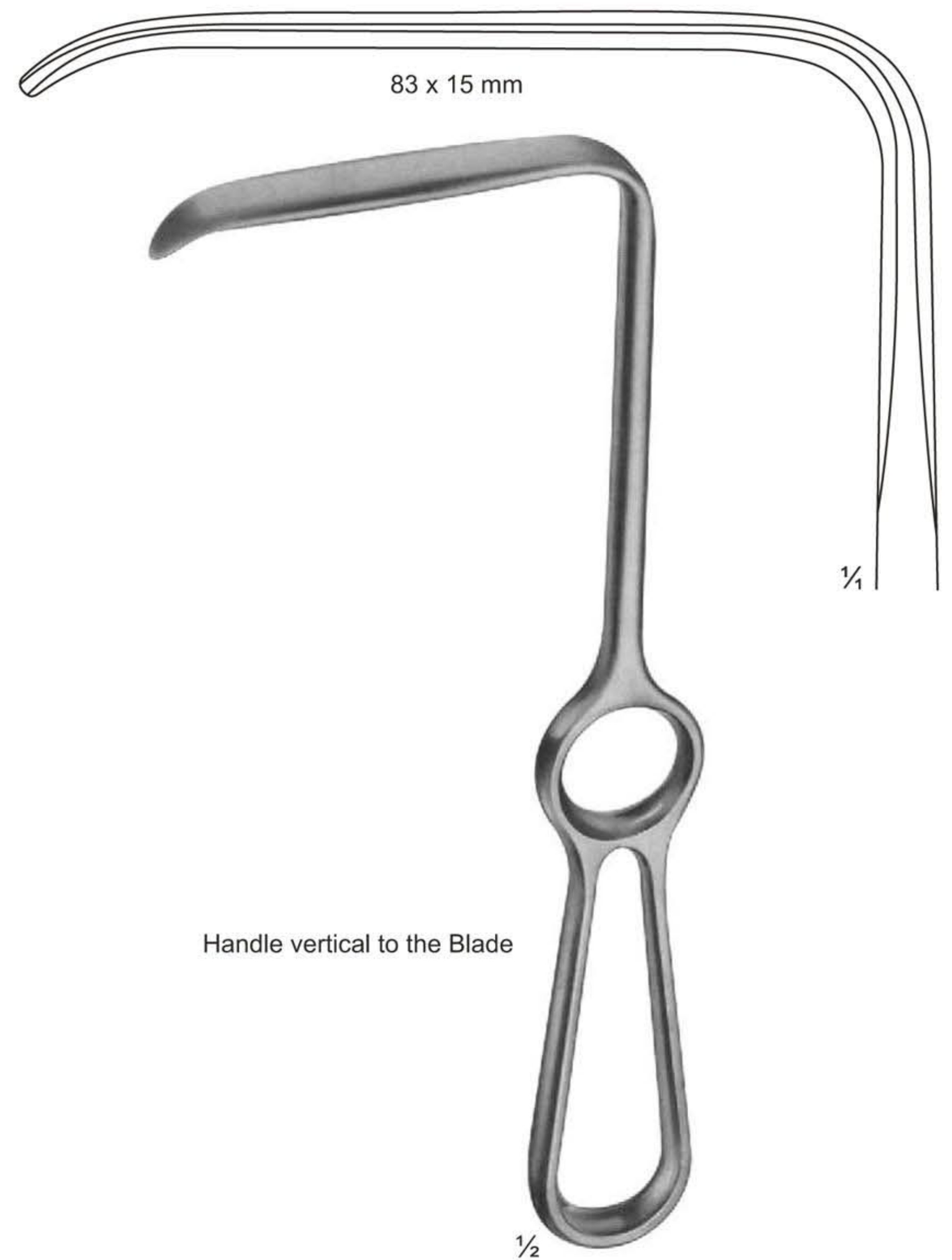

**08-308**  
LANGENBECK  
215 mm



**Retractors**



**08-309 - 313**  
KOCHER  
230 mm

1/2



**08-314 - 316**  
SAUERBRUCH  
225 mm

1/2

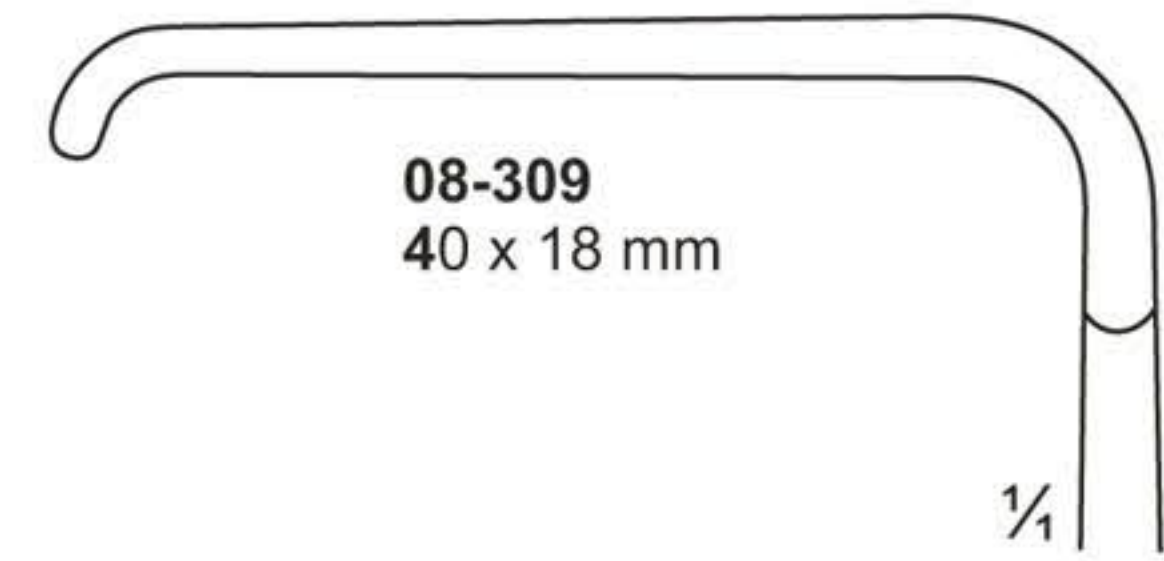

**08-309**  
40 x 18 mm

1/4

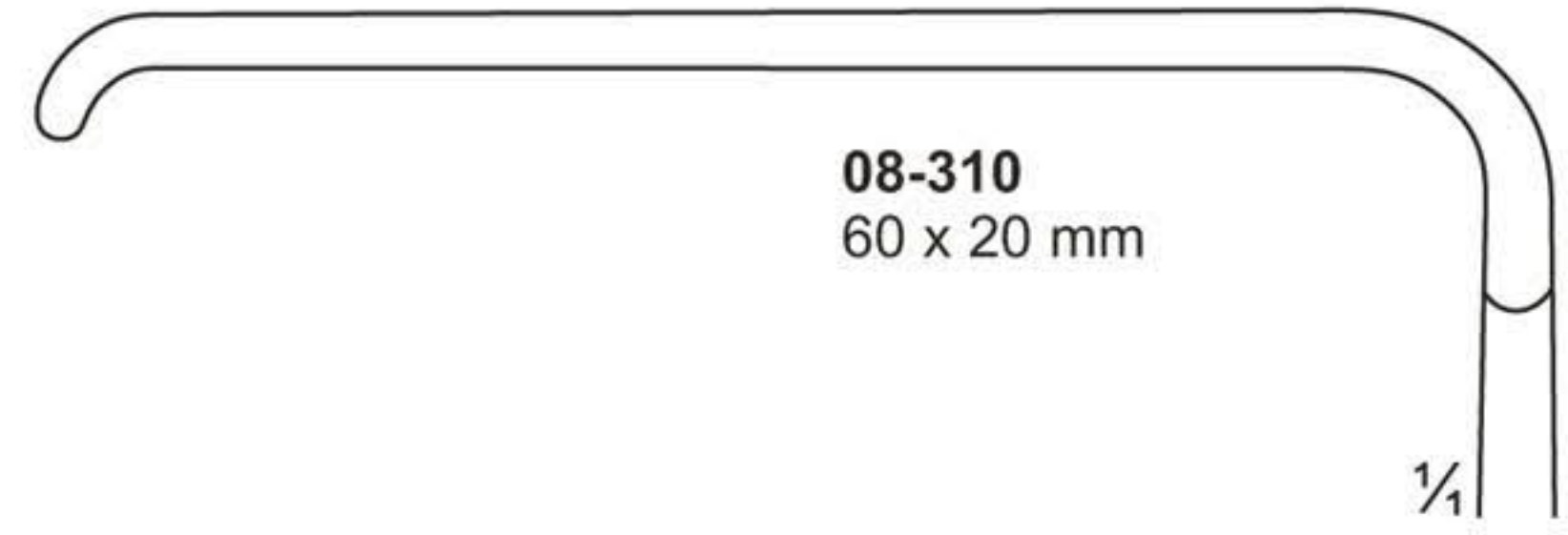

**08-310**  
60 x 20 mm

1/4

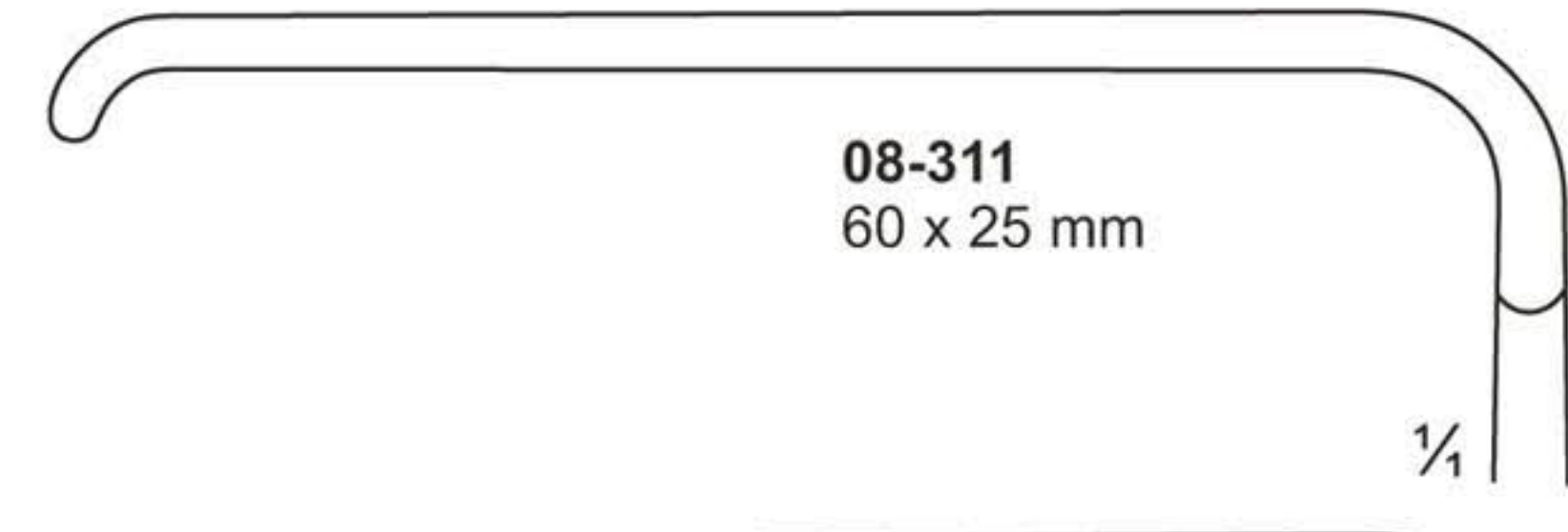

**08-311**  
60 x 25 mm

1/4

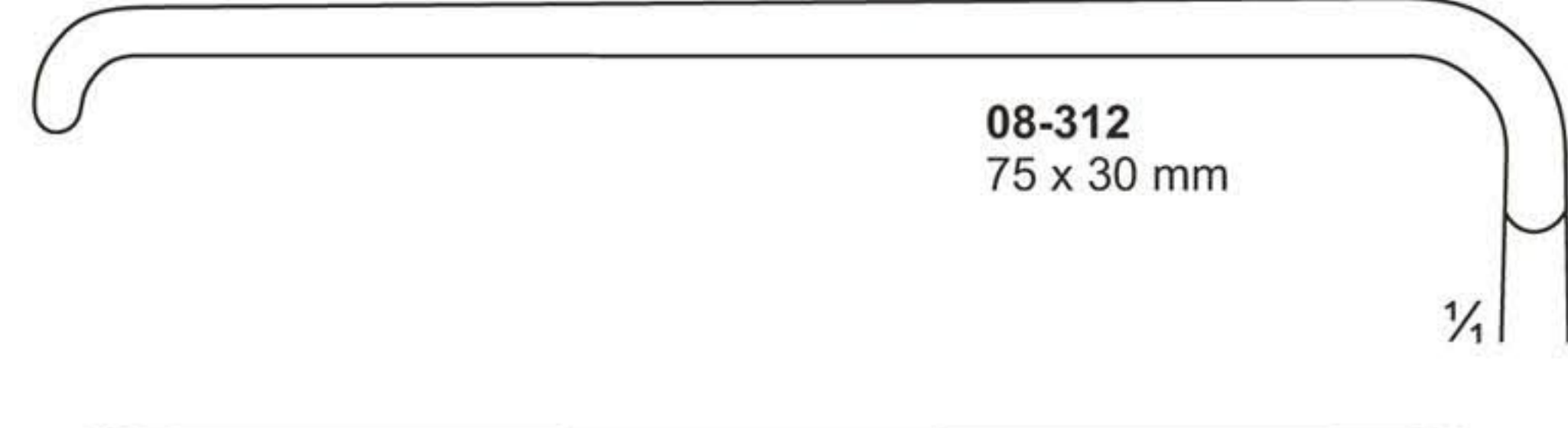

**08-312**  
75 x 30 mm

1/4

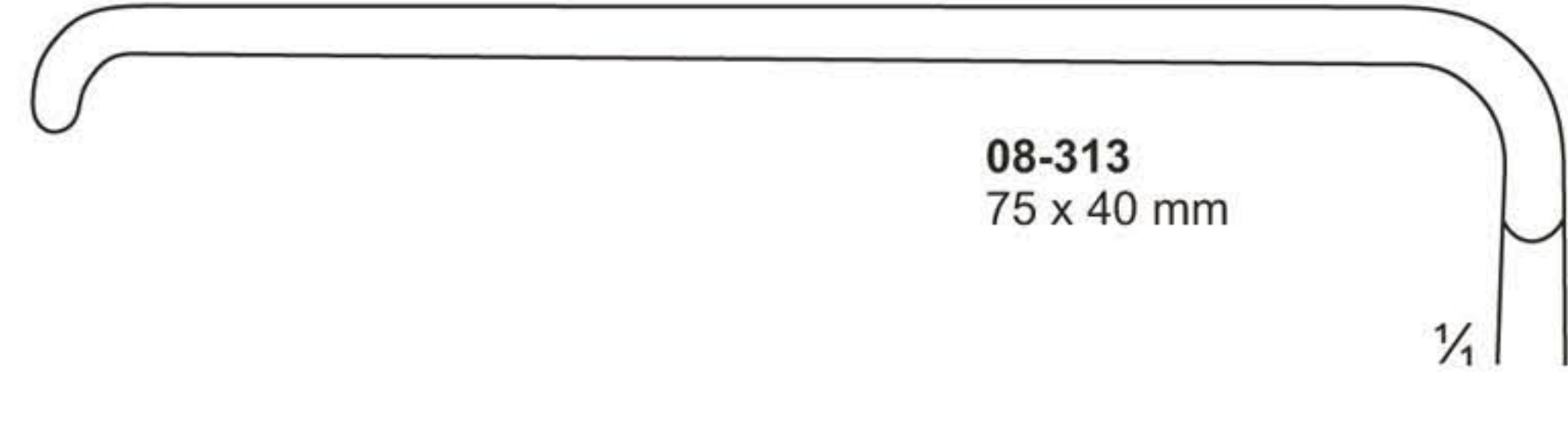

**08-313**  
75 x 40 mm

1/4

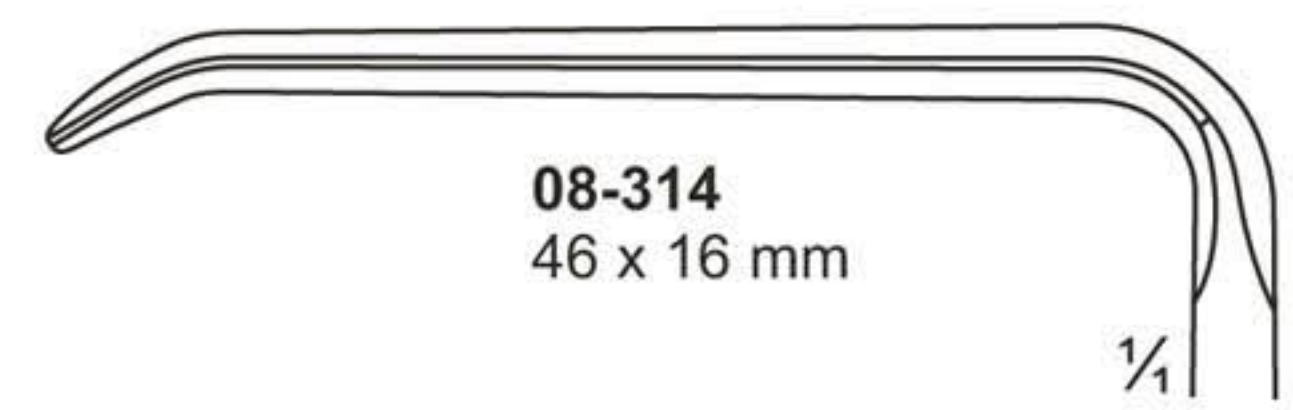

**08-314**  
46 x 16 mm

1/4

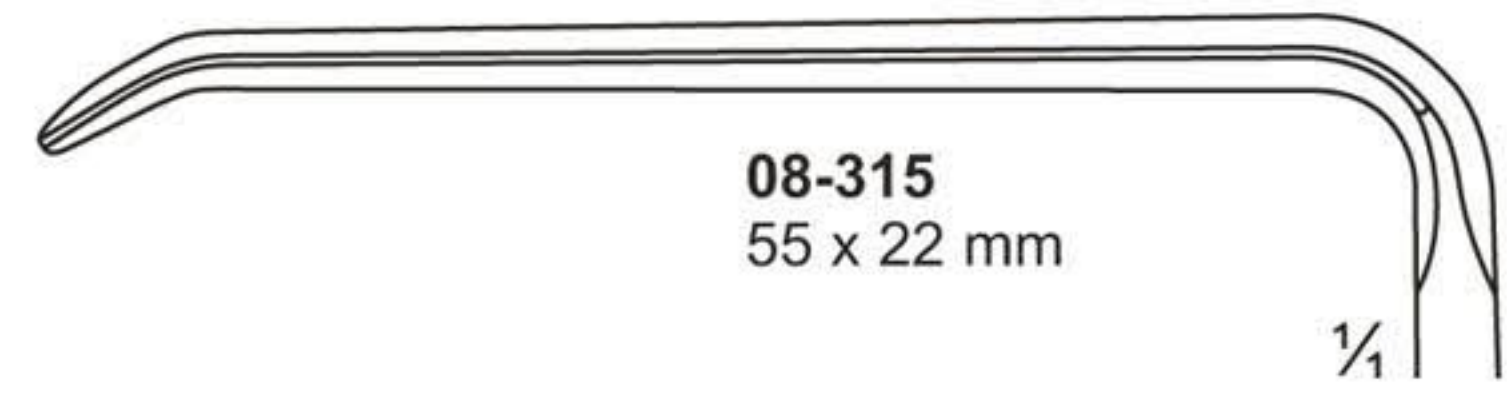

**08-315**  
55 x 22 mm

1/4

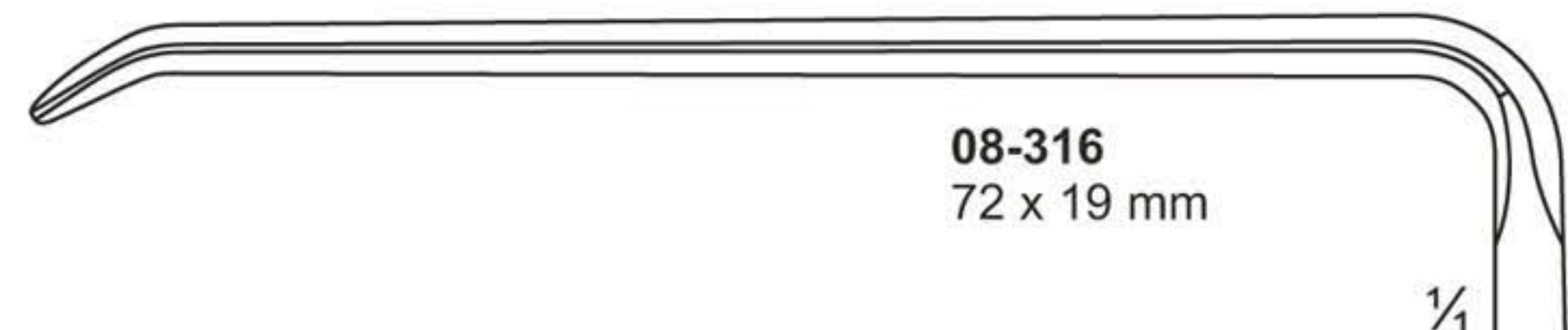

**08-316**  
72 x 19 mm

1/4



**Retractors**



**08-317**  
15 x 15 mm  
220 mm

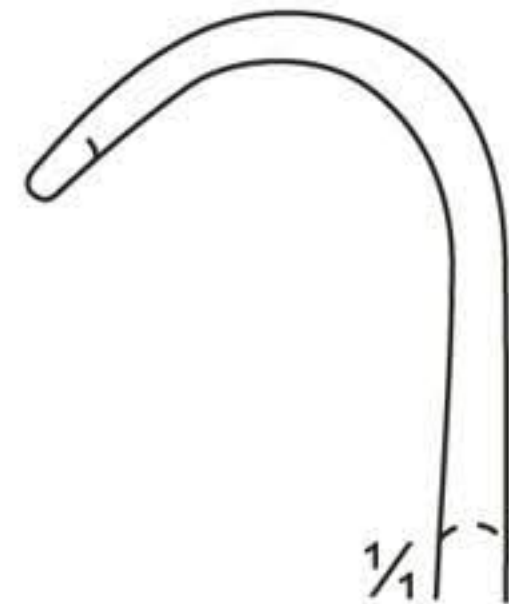

**08-318**  
20 x 22 mm  
215 mm

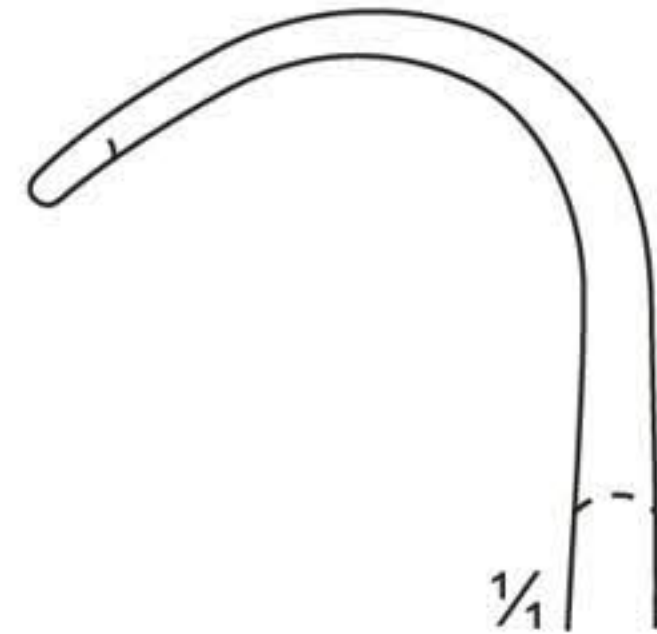

**08-319**  
28 x 28 mm  
235 mm

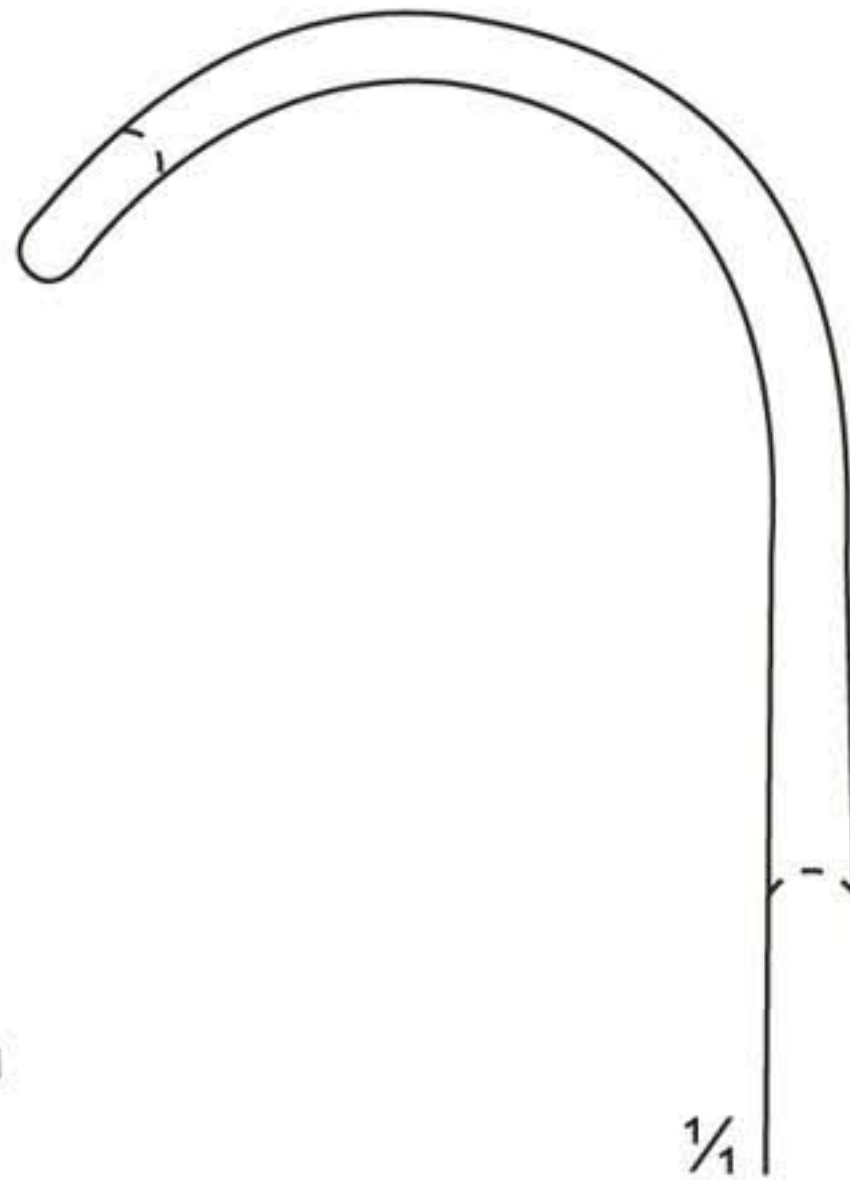

**08-317 - 319**  
MIDDELDORPF

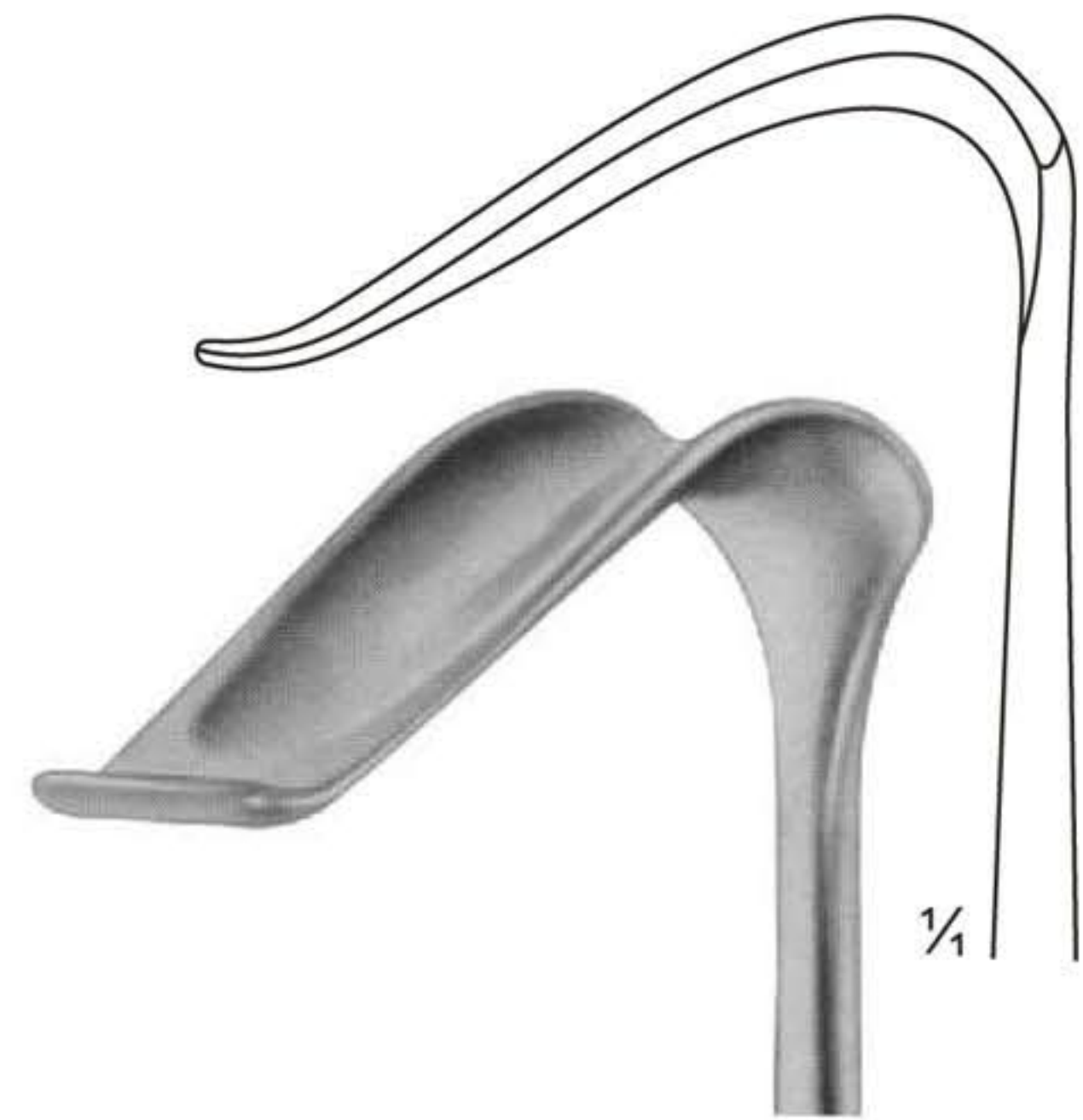

38 x 18 mm

**08-320**  
BUCHS  
205 mm

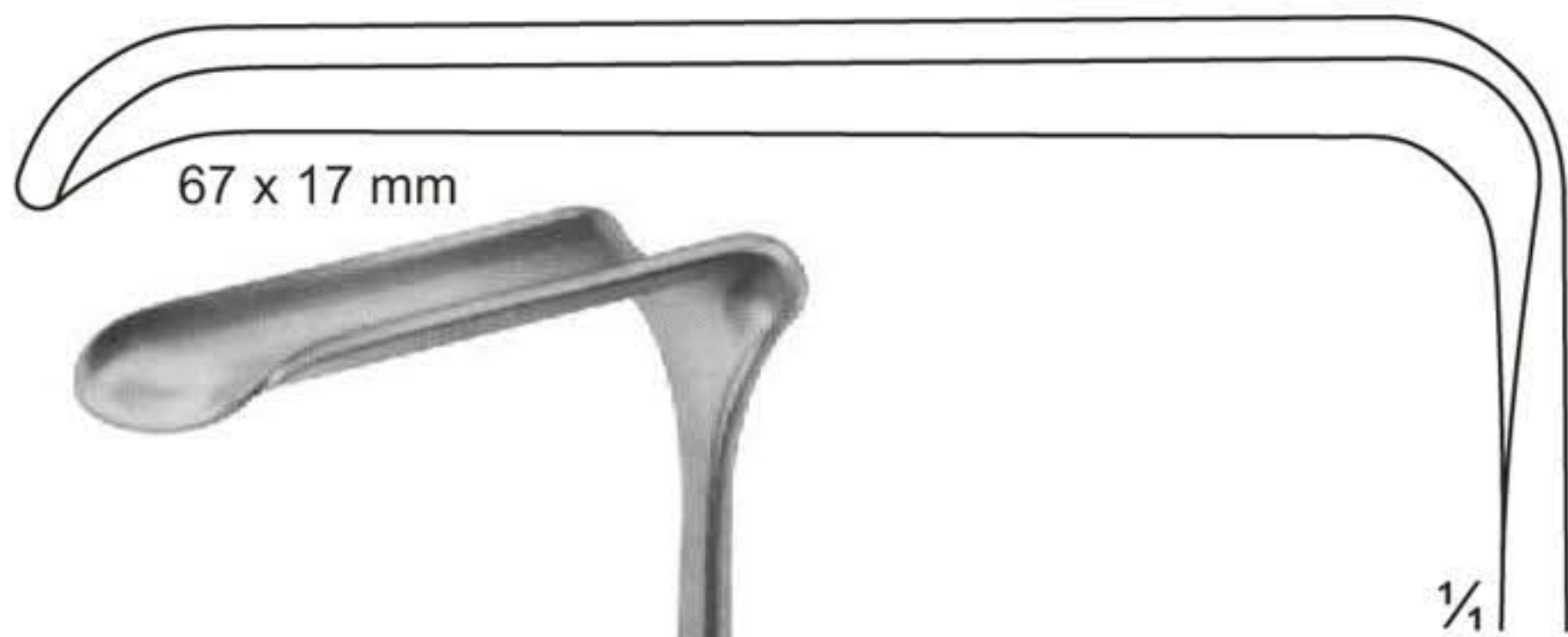

67 x 17 mm



**08-321**  
CASPAR  
210 mm

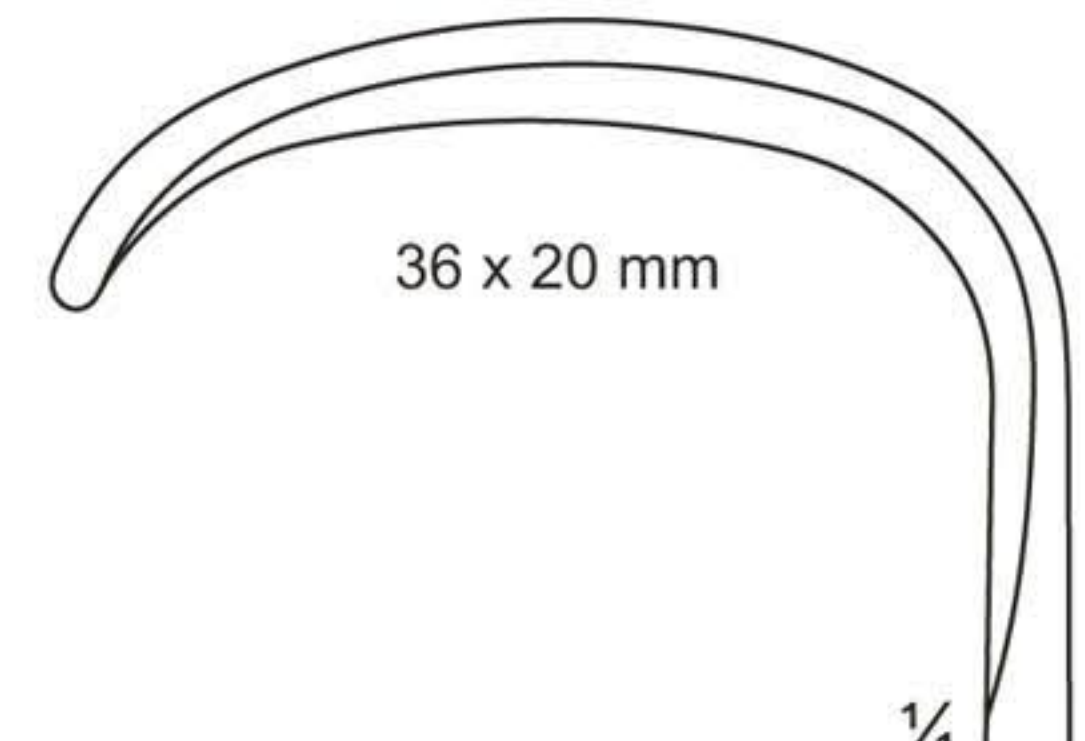

36 x 20 mm

**08-322**  
KOCHER  
230 mm



**Retractors**



1/2  
**08-323 - 328**  
HOSEL  
250 mm

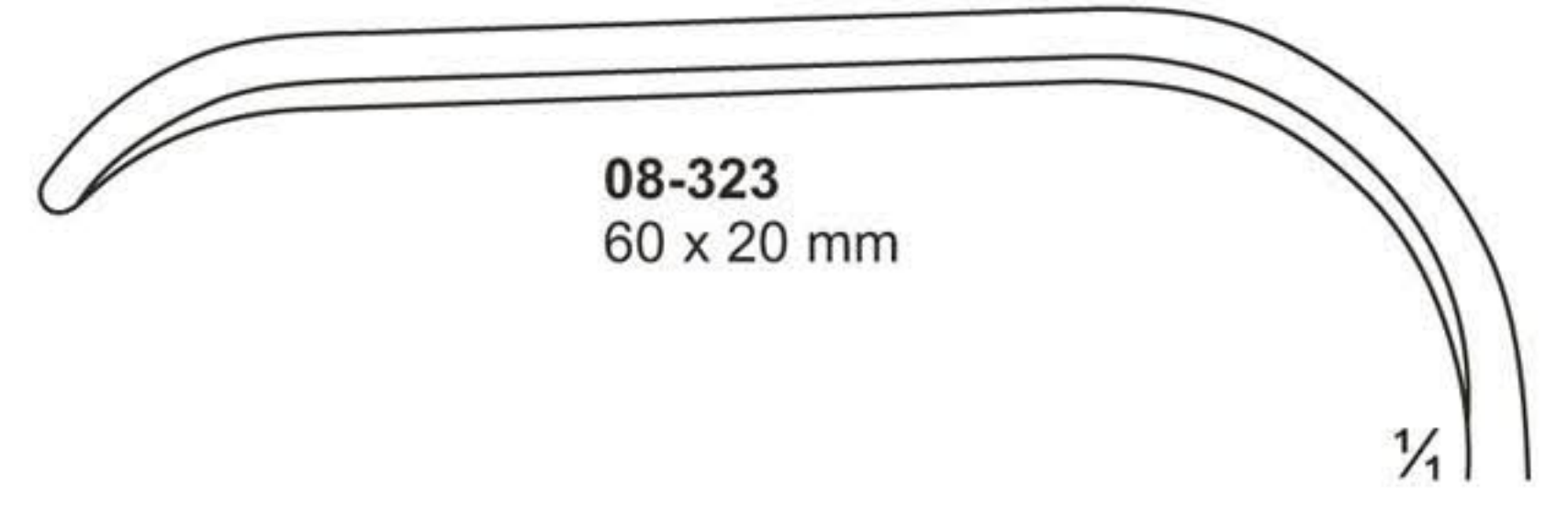

**08-323**  
60 x 20 mm

1/4

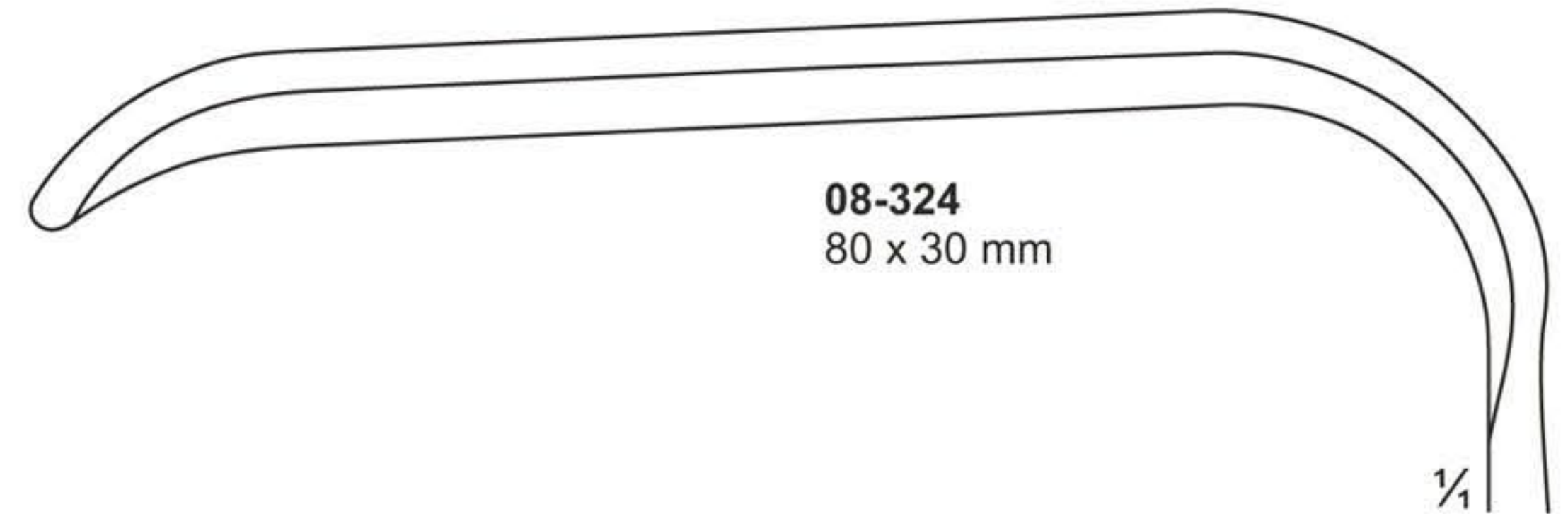

**08-324**  
80 x 30 mm

1/4

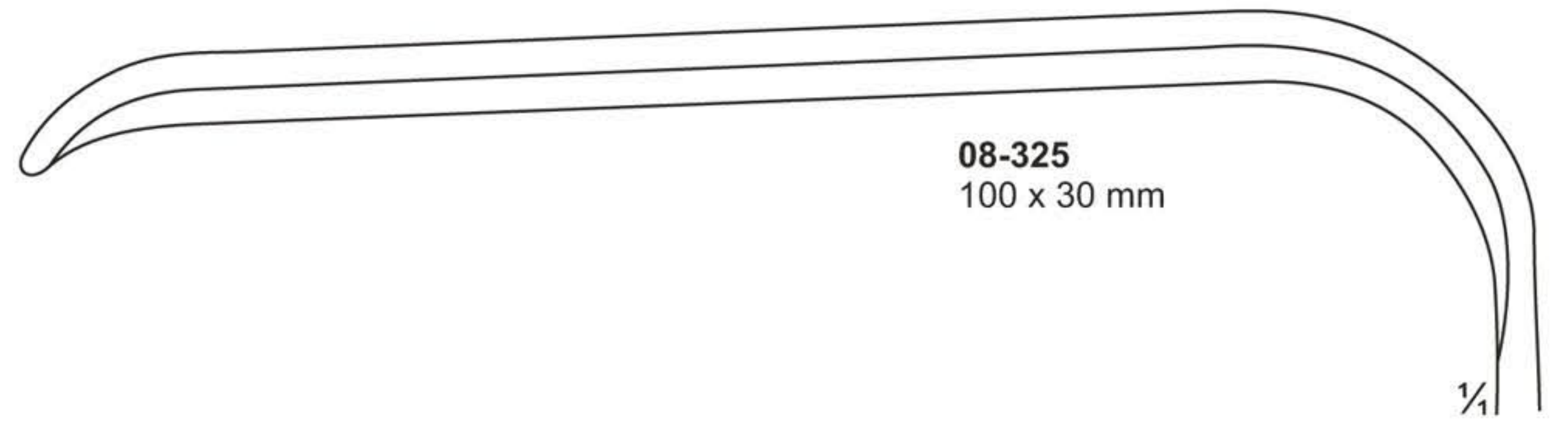

**08-325**  
100 x 30 mm

1/4

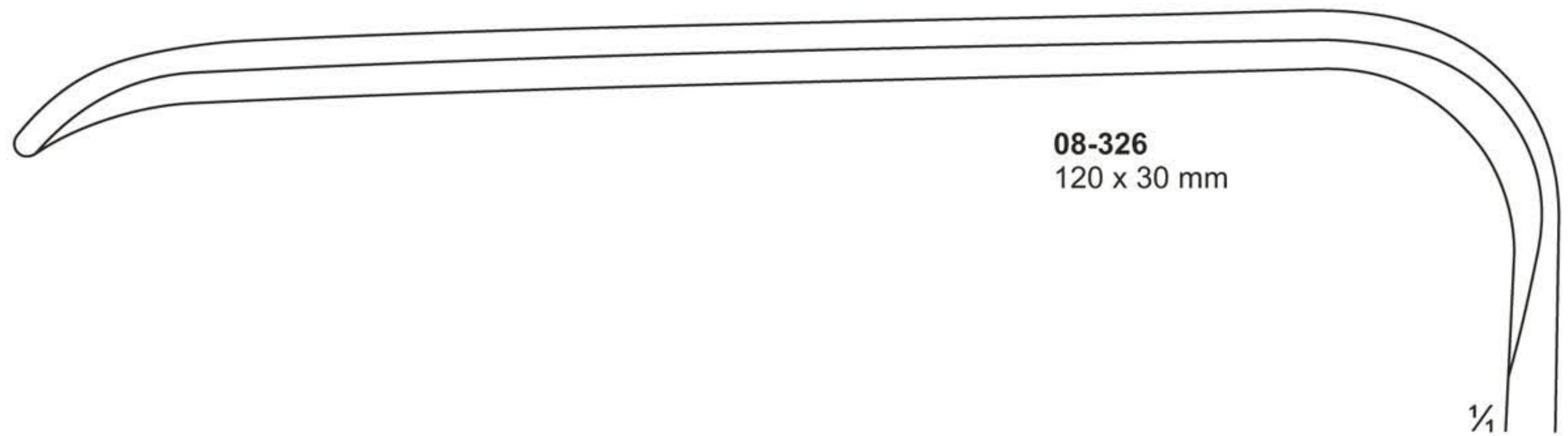

**08-326**  
120 x 30 mm

1/4

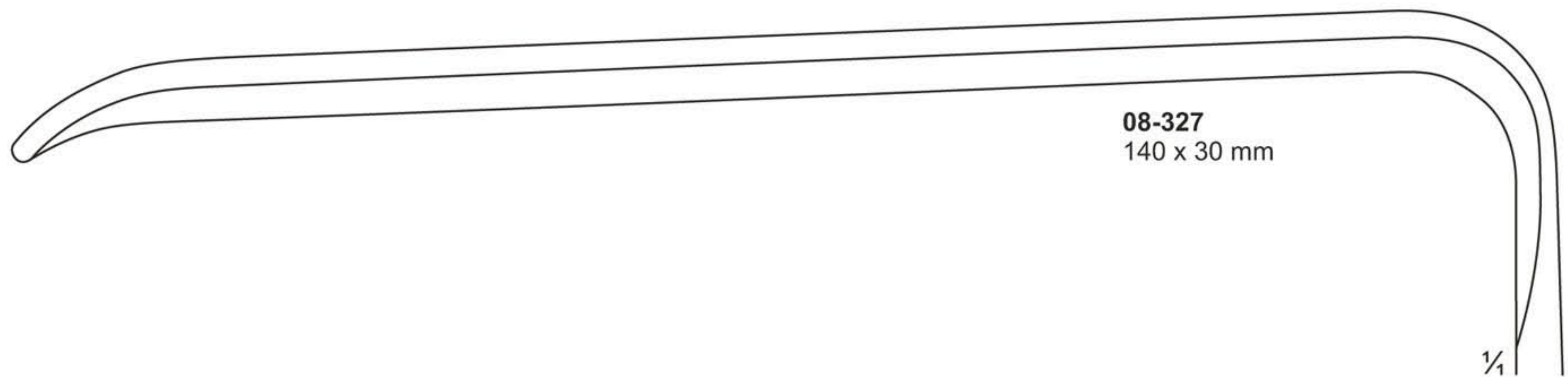

**08-327**  
140 x 30 mm

1/4

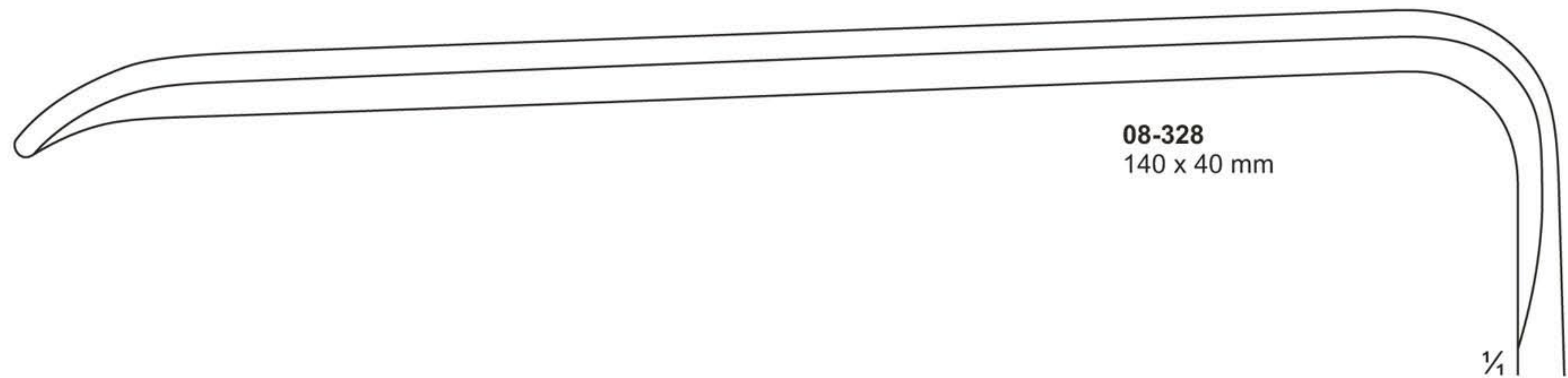

**08-328**  
140 x 40 mm

1/4



**Retractors**

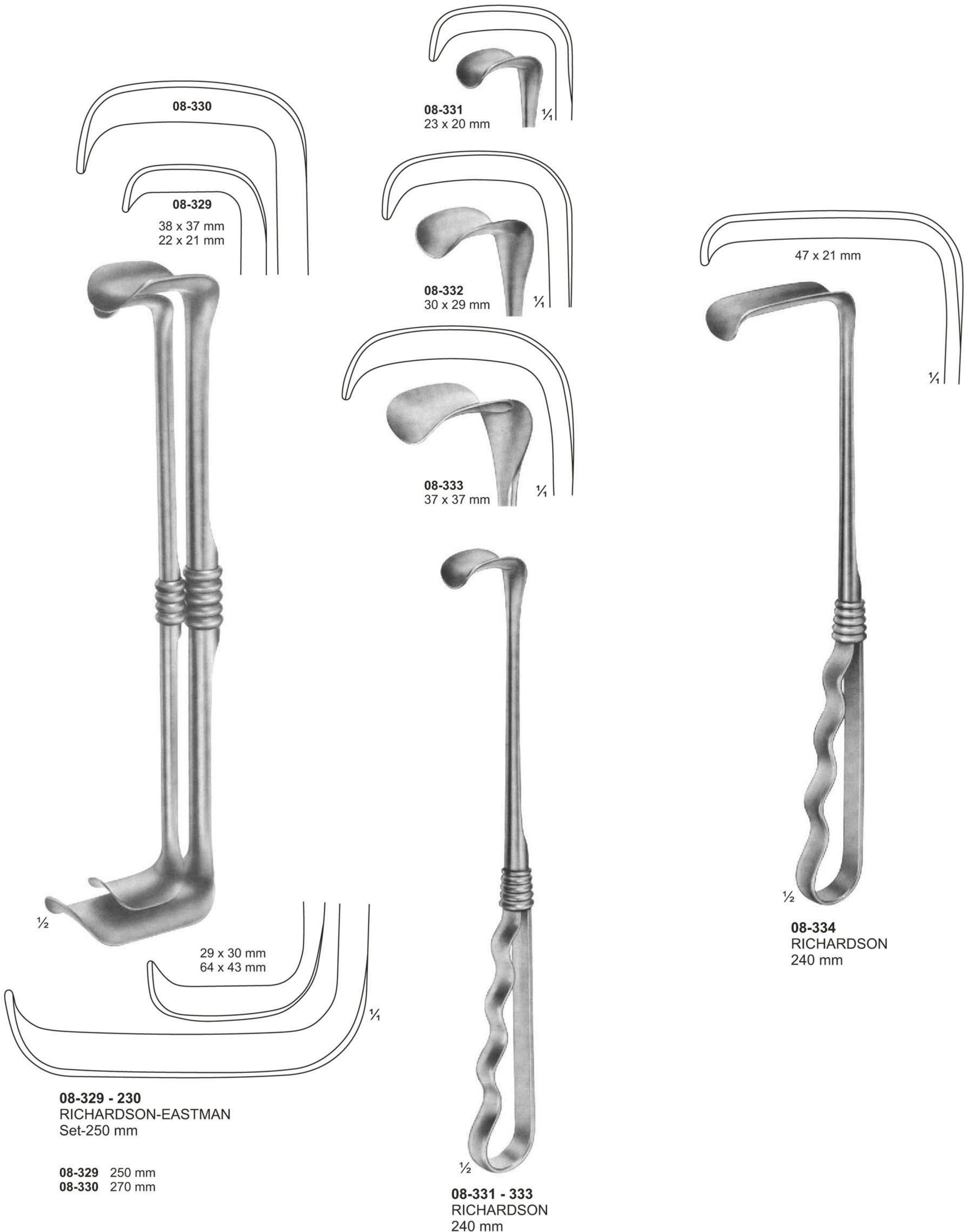



Retractors

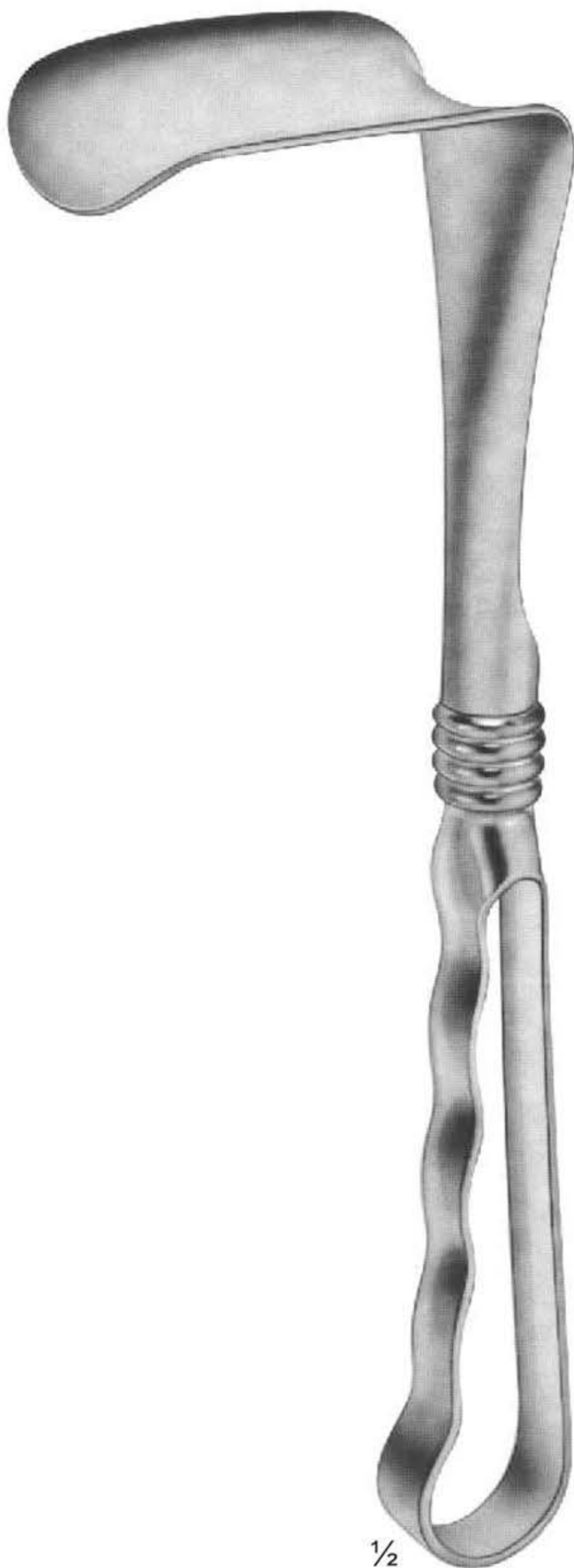
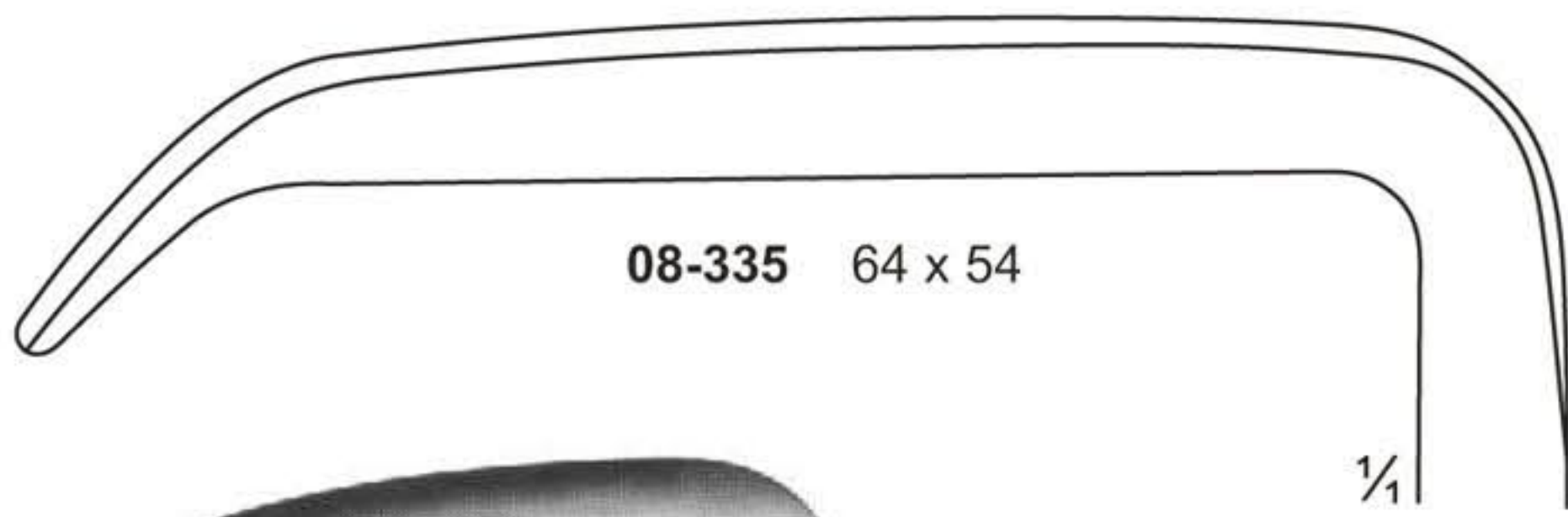
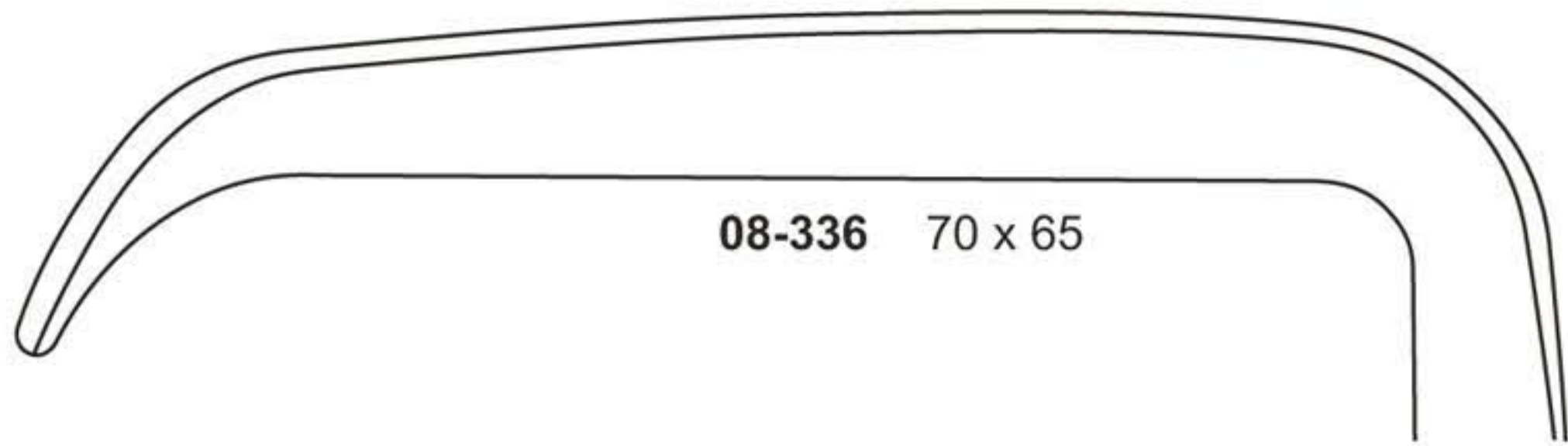

08-335 - 336  
KELLY  
260 mm

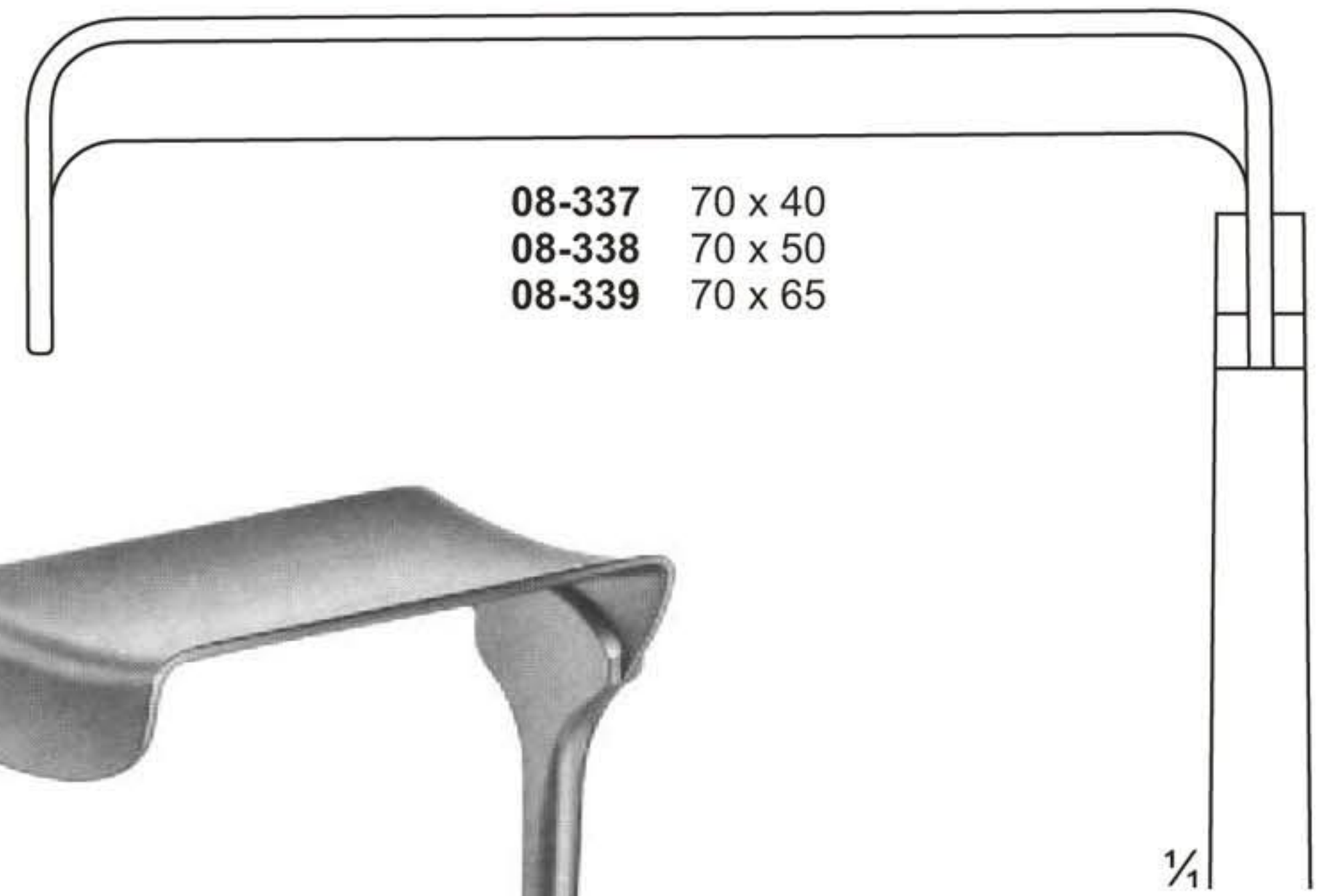

08-337 - 339  
MORRIS  
245 mm



# Retractors For Deep Surgery





# Retractors For Deep Surgery

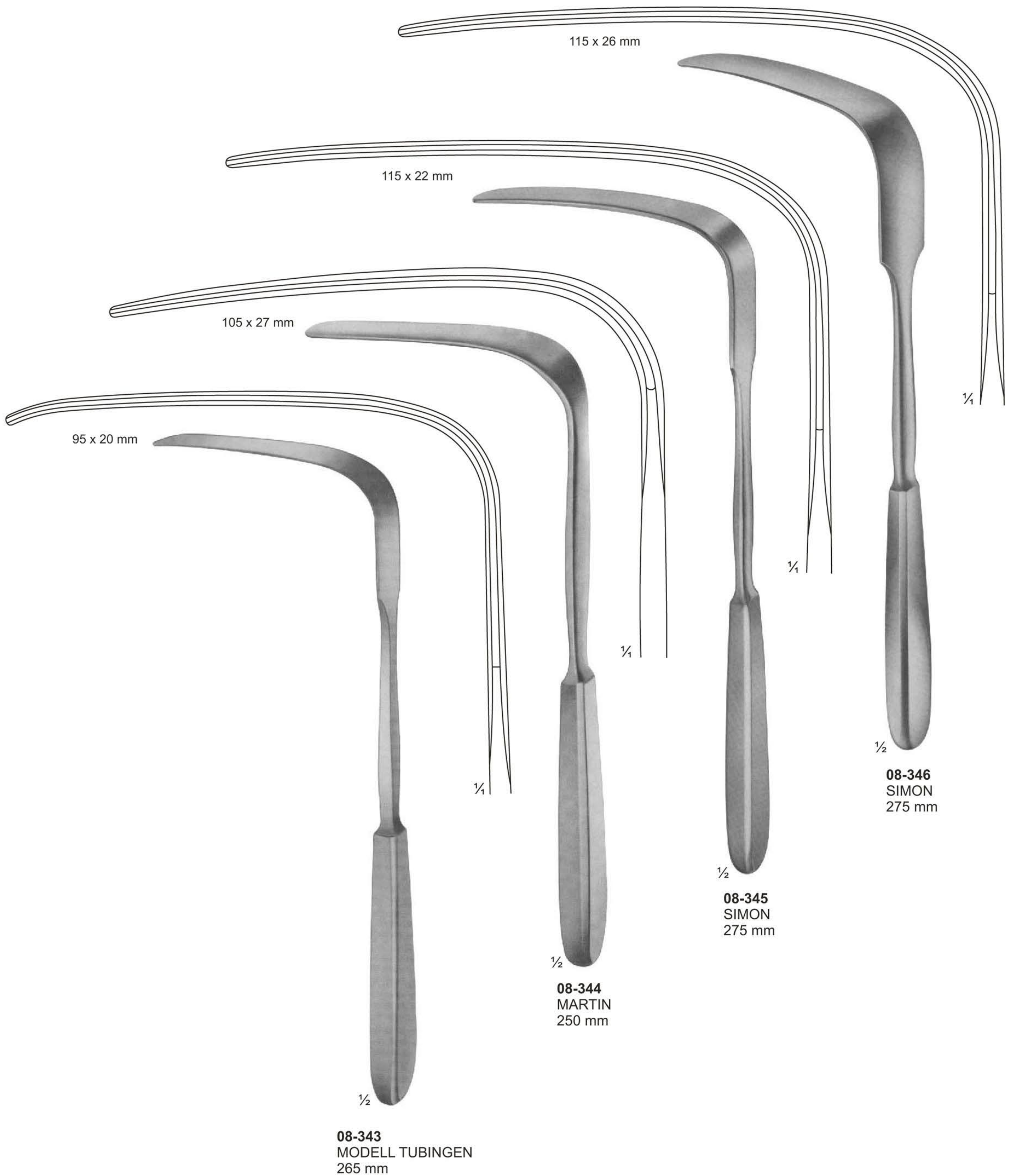



**Vario Retractor System, Germ. Fed. Patent,  
Germ. Fed. Regd.Des.**

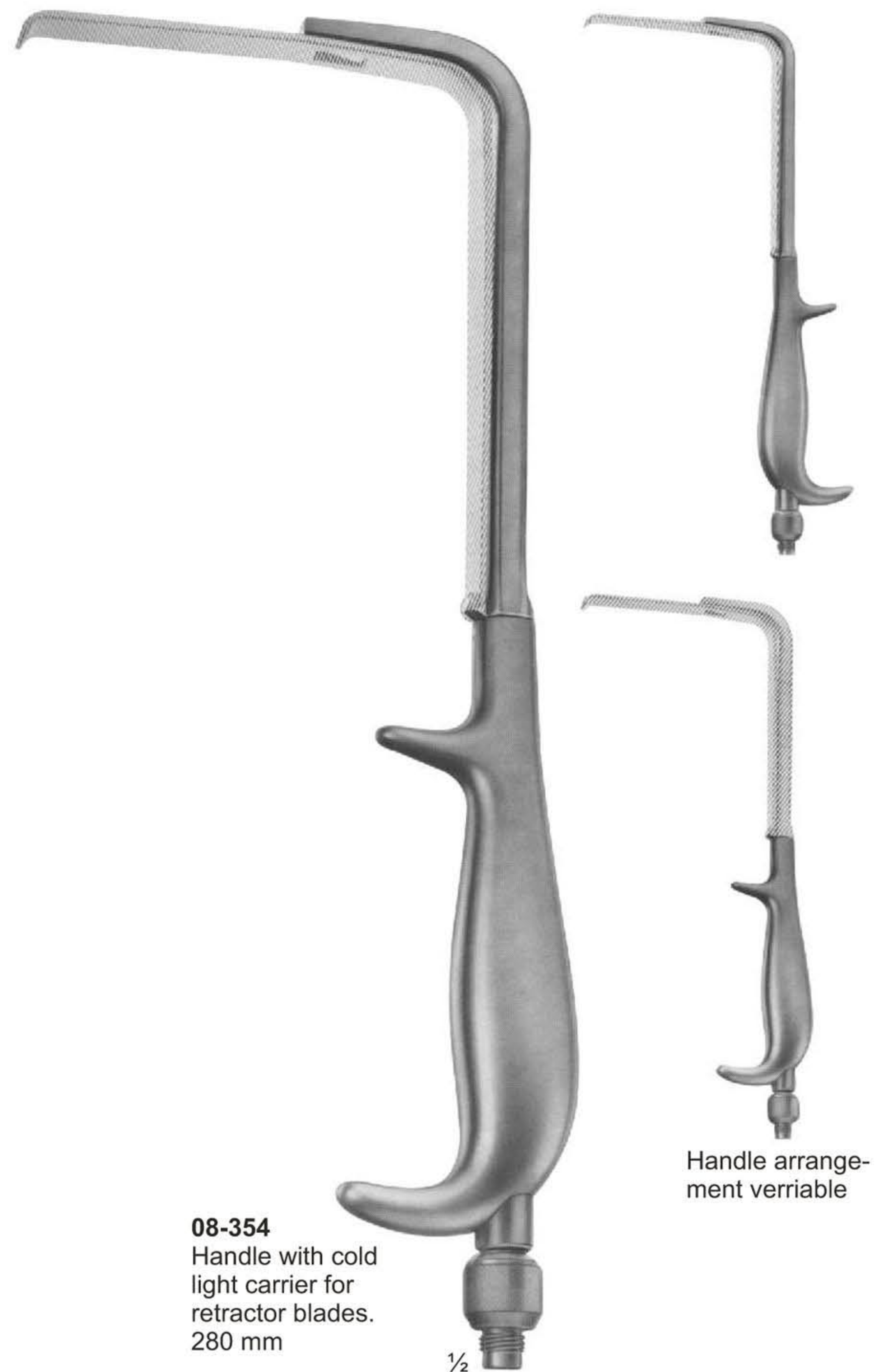



# Retractors, Lung Spatulas

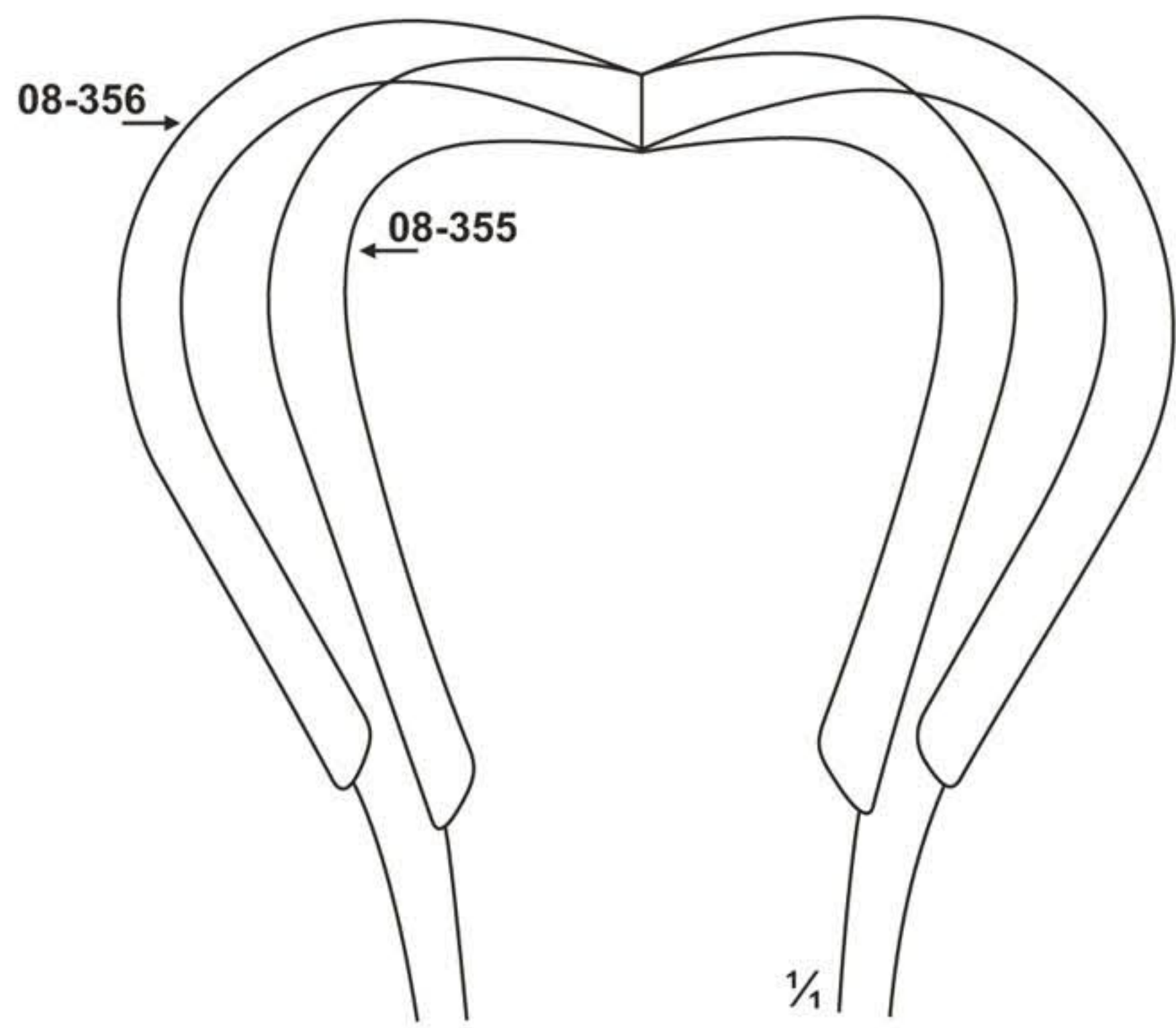

**08-355 - 356**  
HARRINGTON  
08-355 123 x 45 mm  
08-356 123 x 64 mm  
Flexible  
295 mm



**08-357**  
ALLISON  
255 mm

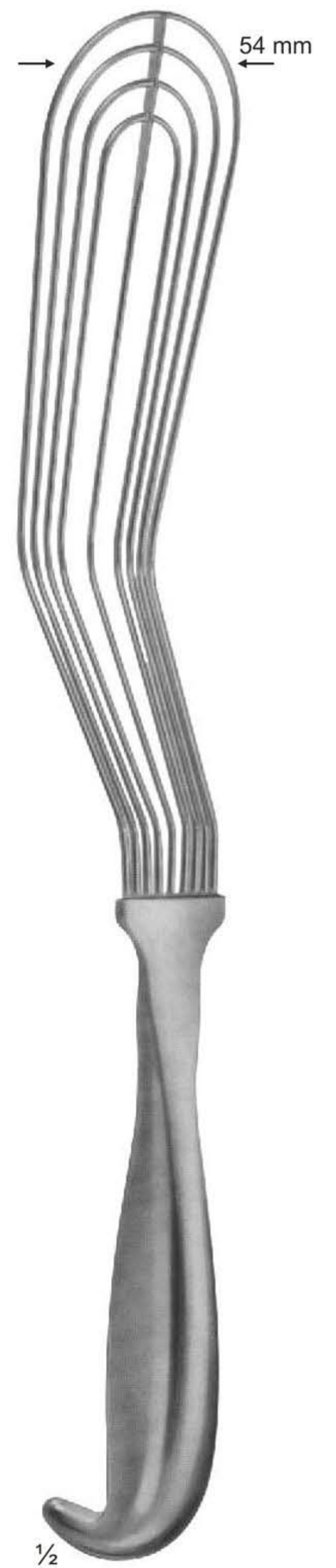

**08-358**  
ALLISON  
320 mm



Retractors, Lung Spatulas





# Retractors, Lung Spatulas



**08-364**  
DEAVER  
300 mm  
Fig. 1

**08-365**  
DEAVER  
315 mm  
Fig. 2

**08-366**  
DEAVER  
365 mm  
Fig. 2



# Retractors, Lung Spatulas



**08-367**  
DEAVER  
300 mm  
Fig. 3

**08-368**  
DEAVER  
310 mm  
Fig. 4

**08-369**  
DEAVER  
320 mm  
Fig. 5



## Retractors, Lung Spatulas

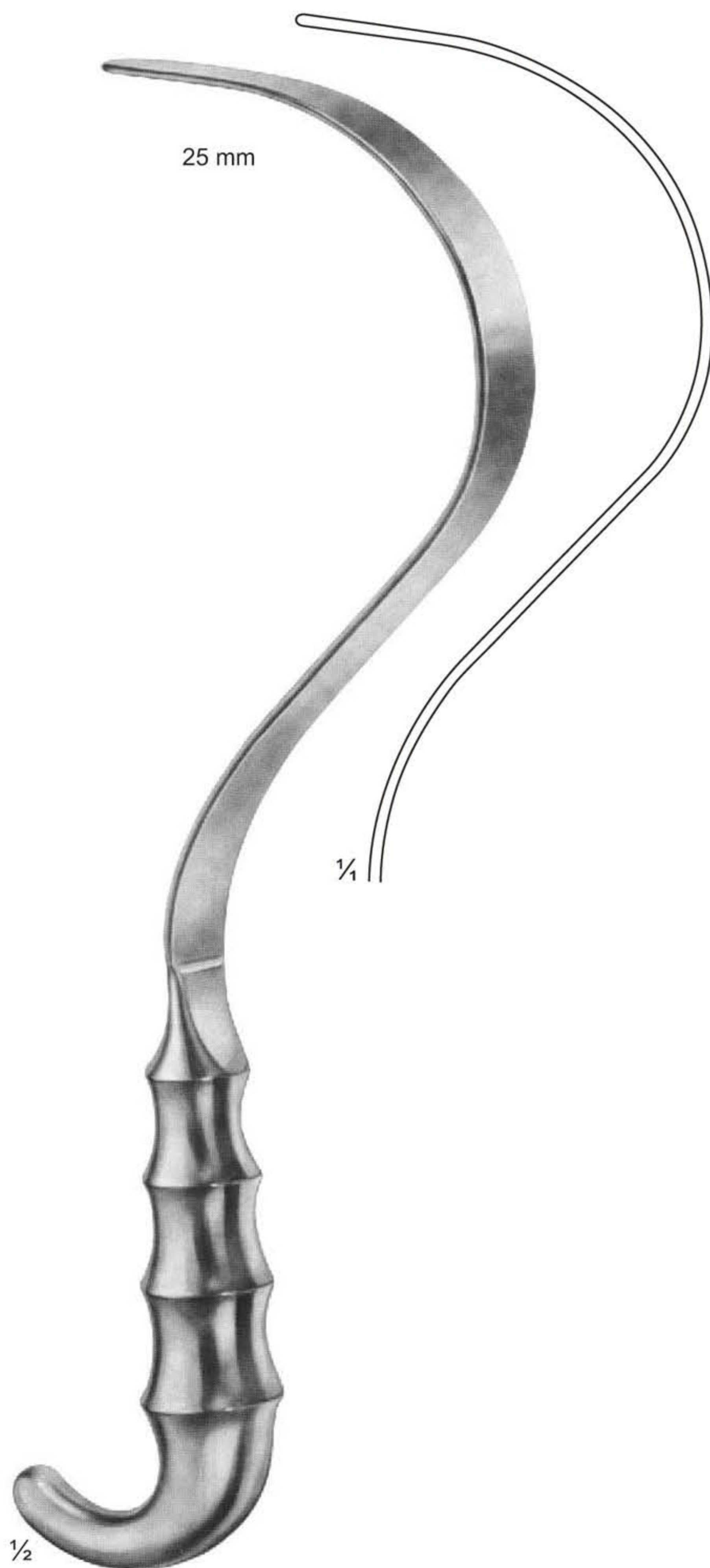

**08-370**  
DEAVER  
310 mm  
Fig. 1



**08-371**  
DEAVER  
310 mm  
Fig. 3



## Retractors, Lung Spatulas



**08-372**  
DEAVER  
305 mm  
Fig. 3



**08-373**  
DEAVER  
310 mm  
Fig. 4



## Retractors For Deep Surgery (Abdominal Retractors)

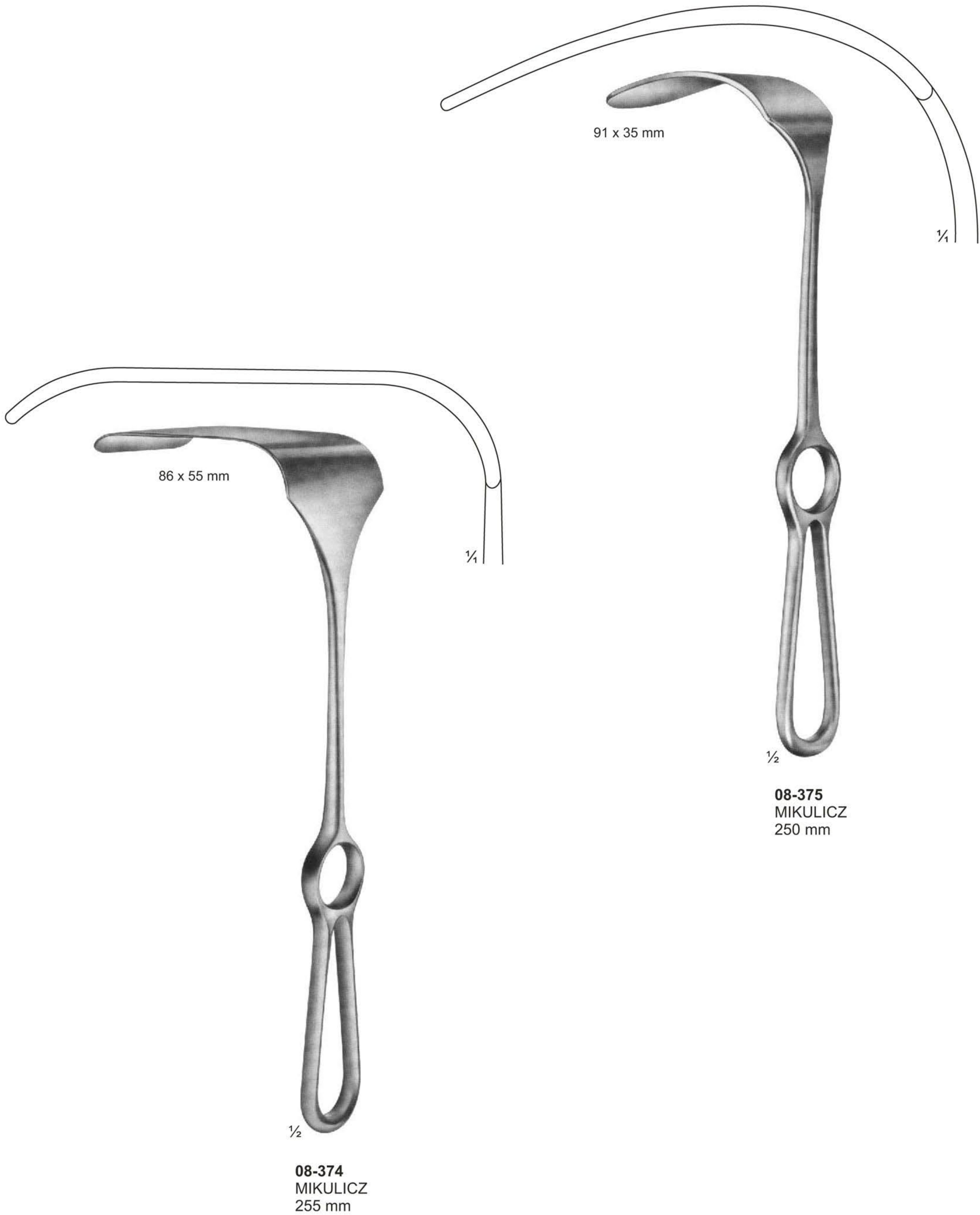



# Retractors For Deep Surgery (Abdominal Retractors)

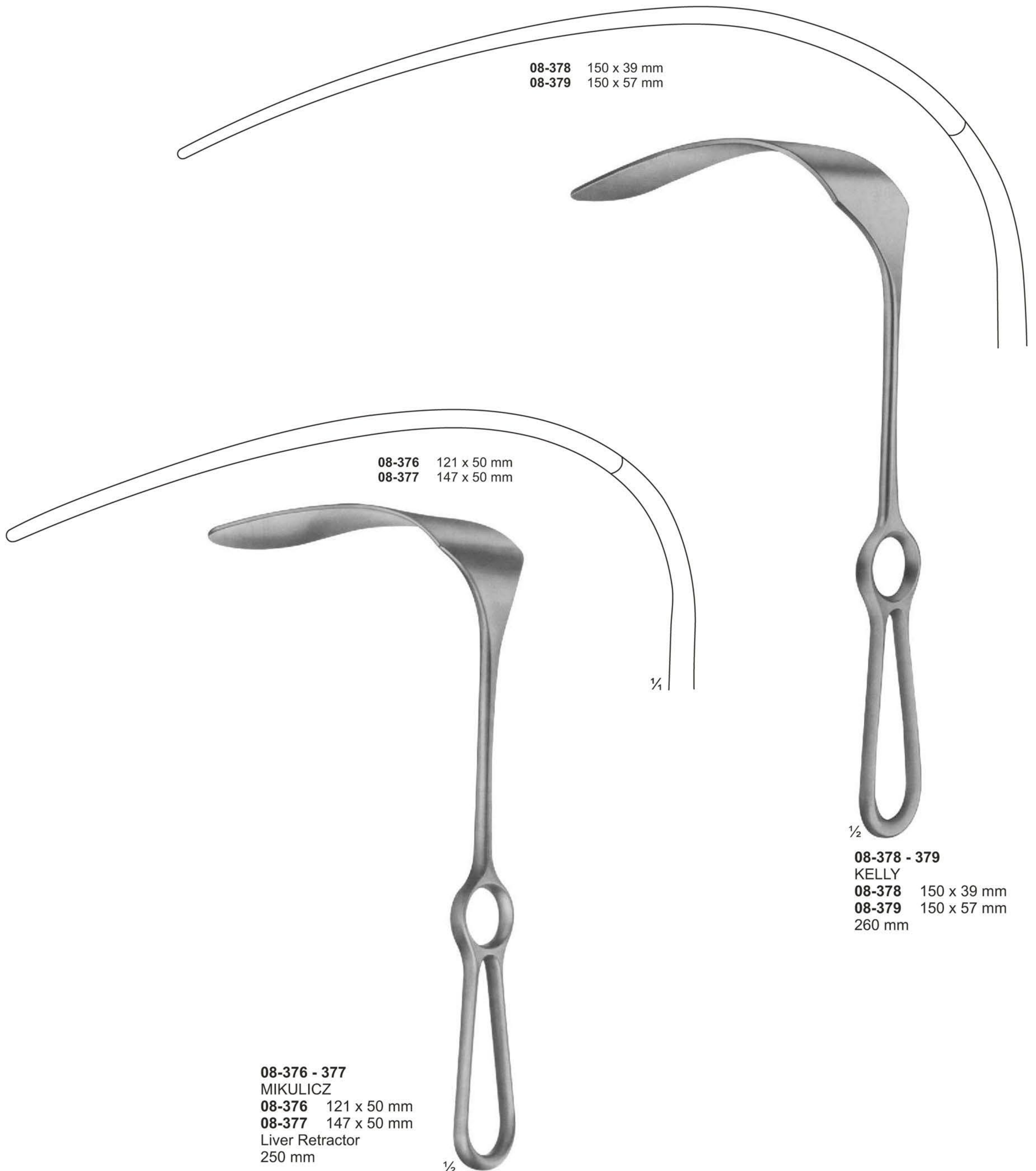



Retractors, Abdominal Retractors

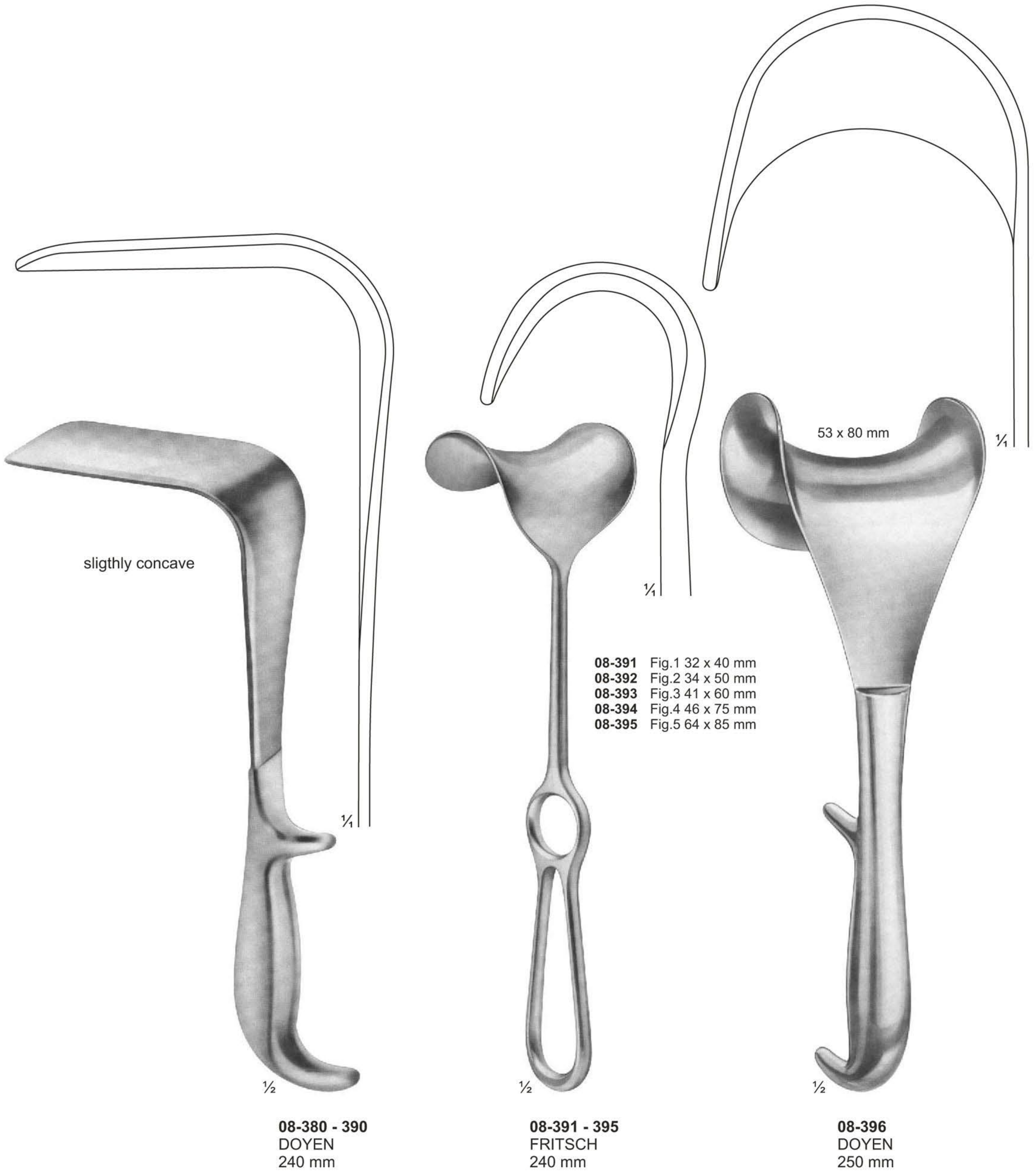

- 08-391 Fig.1 32 x 40 mm
- 08-392 Fig.2 34 x 50 mm
- 08-393 Fig.3 41 x 60 mm
- 08-394 Fig.4 46 x 75 mm
- 08-395 Fig.5 64 x 85 mm

**08-380 - 390**  
DOYEN  
240 mm

**08-391 - 395**  
FRITSCH  
240 mm

**08-396**  
DOYEN  
250 mm

<b>Width of Blades</b>	
35 mm, 45 mm, 60 mm	
<b>Length of Blades</b>	
62 mm	08-380 , 08-381 , 08-382
92 mm	08-383 , 08-384 , 08-385
122 mm	08-386 , 08-387 , 08-388
160 mm	08-389 , 08-390



## Abdominal Retractors



**08-397 - 401**  
ROCHARD  
310 mm  
08-397 48 x 90 mm  
08-398 48 x 105 mm  
08-399 48 x 120 mm  
08-400 48 x 135 mm  
08-401 48 x 155 mm

1/3



1/3

**08-402**



1/3

**08-403 - 406**  
DOYEN  
280 mm  
08-403 48 x 90 mm  
08-404 48 x 105 mm  
08-405 48 x 120 mm  
08-406 48 x 135 mm



1/3

**08-407**  
DOYEN-CHILD  
Fixation device  
220 mm



**08-408**  
Chain with  
weight (747 / 645g)  
790 mm



**Pelvis Retractors**

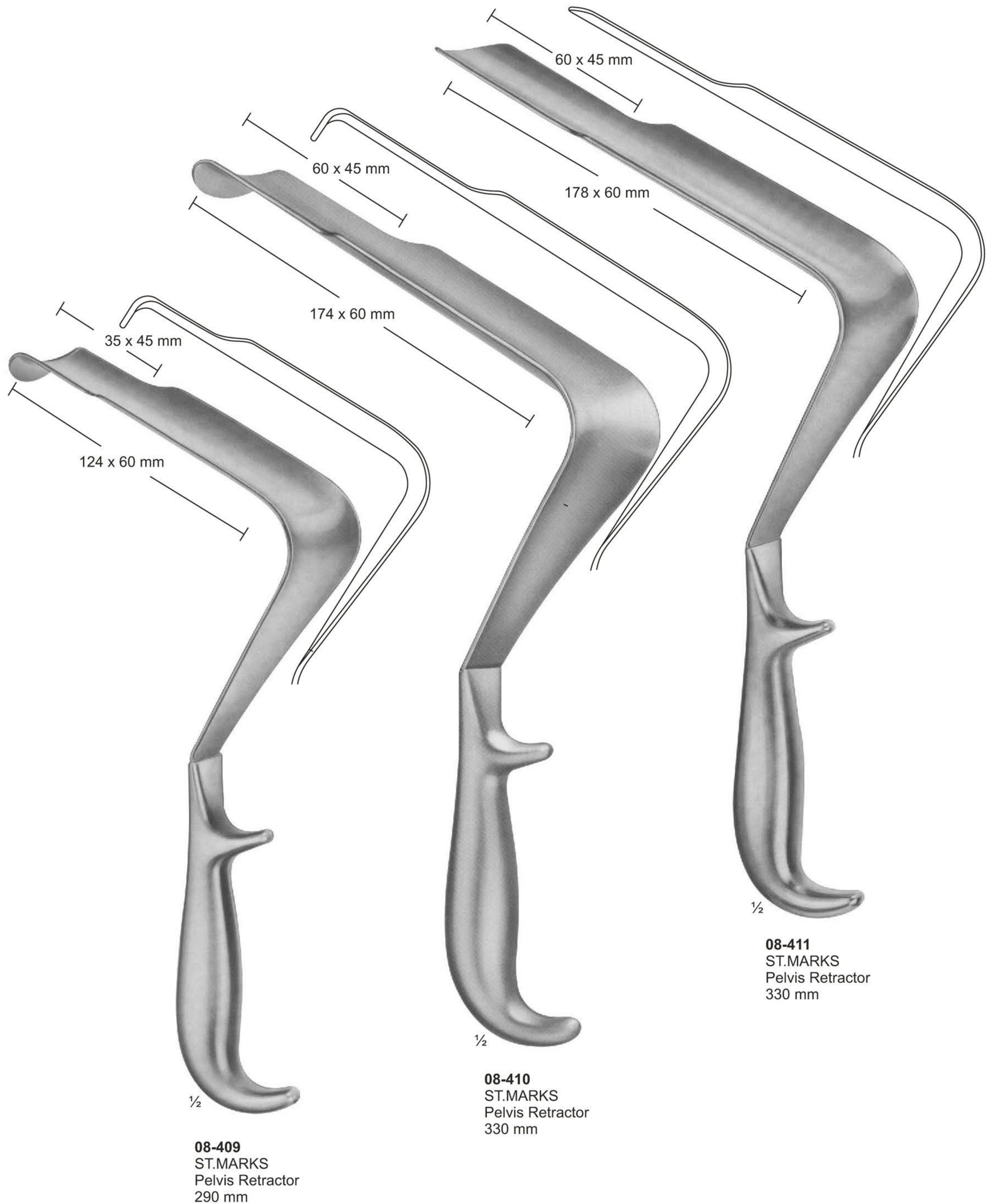



# Abdominal- and Intestinal Spatulas

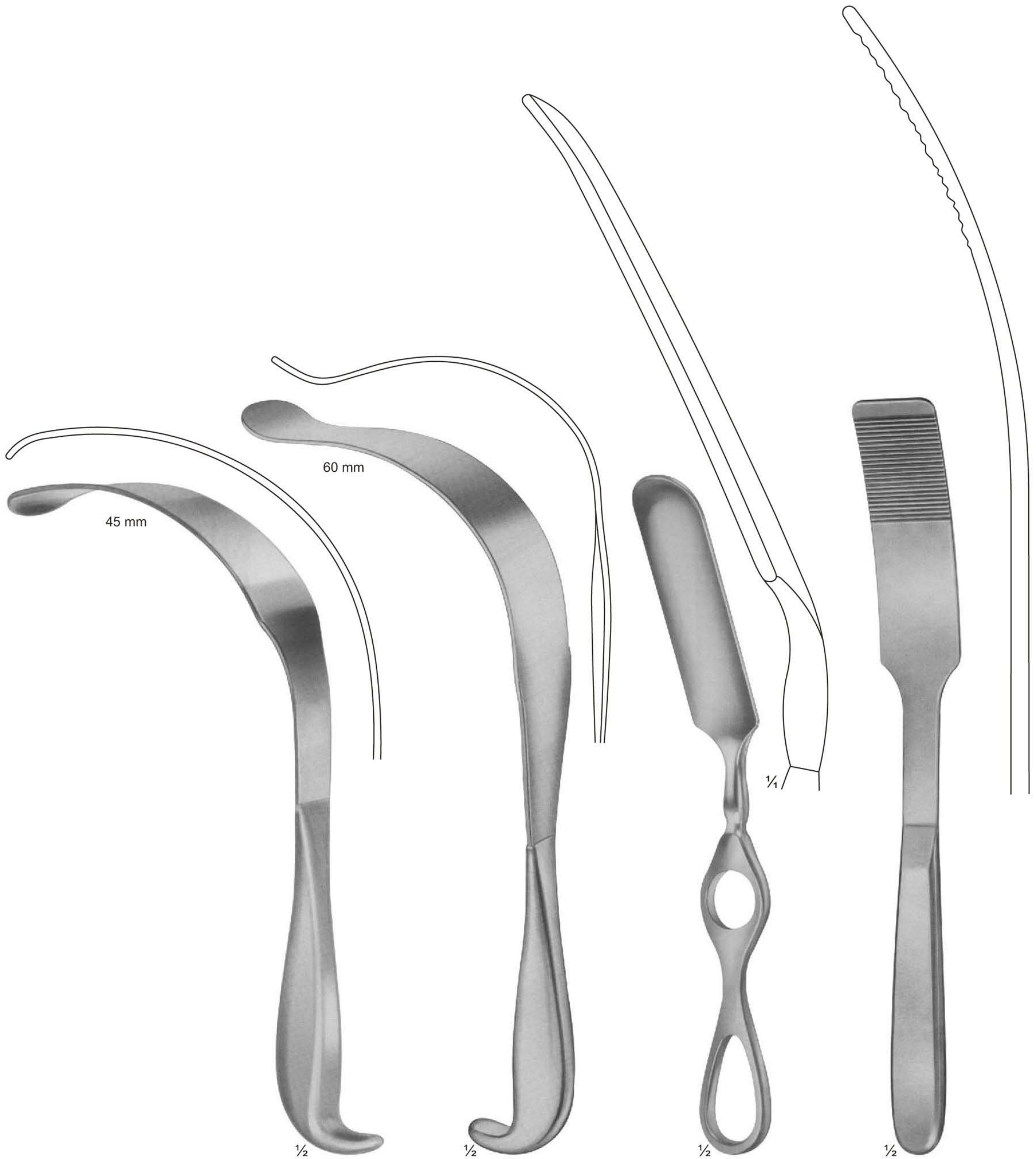

**08-412**  
LERICHE  
255 mm

**08-413**  
KUMMEL  
Malleable  
285 mm

**08-414**  
MIKULICZ  
29 mm  
250 mm

**08-415 - 416**  
KADER  
**08-415** 30 mm  
**08-416** 40 mm  
270 mm



# Abdominal- and Intestinal Spatulas



**08-417**  
REVERDIN  
285 mm



**08-418**  
HABERER  
Malleable  
305 mm



**08-419** 30 mm  
**08-420** 40 mm  
**08-421** 50 mm  
Malleable  
330 mm



**08-422**  
TUFFIER  
Malleable  
200 mm



# Self-Retaining Retractors



**08-423**  
BOSE  
60 mm



**08-424**  
FINSEN  
50 mm



**08-425**  
FINSEN  
70 mm



**08-426**  
FINSEN modif.  
75 mm



**08-427**  
45 mm



**08-428**  
55 mm



**08-429**  
MUELLER  
65 mm



**08-430**  
100 mm



**08-431 - 432**  
ALM  
**08-431** 70 mm  
**08-432** 100 mm

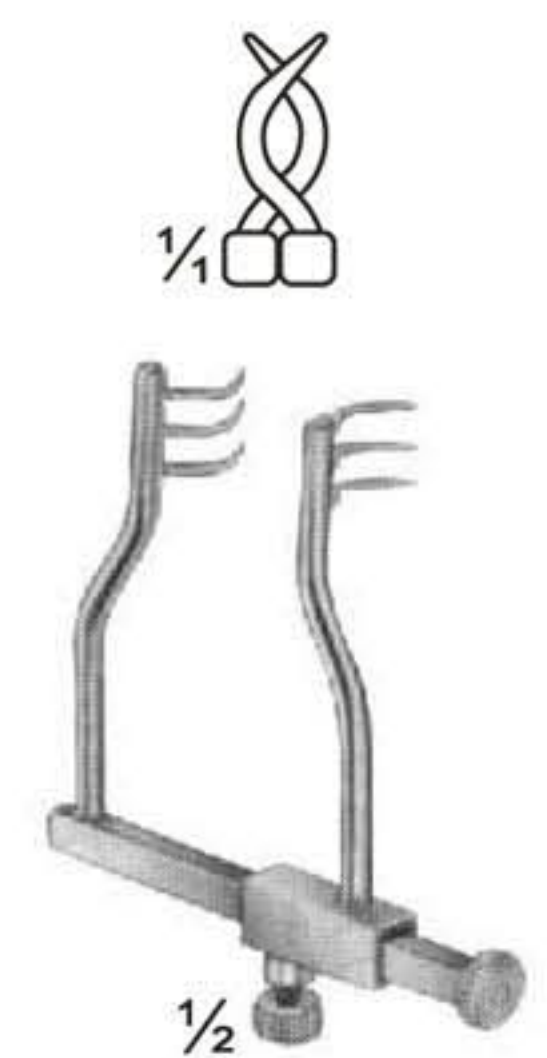

**08-433**  
LOGAN  
modif. REILL  
50 mm



**08-434**  
JANSEN  
100 mm



**08-435**  
JANSEN  
100 mm

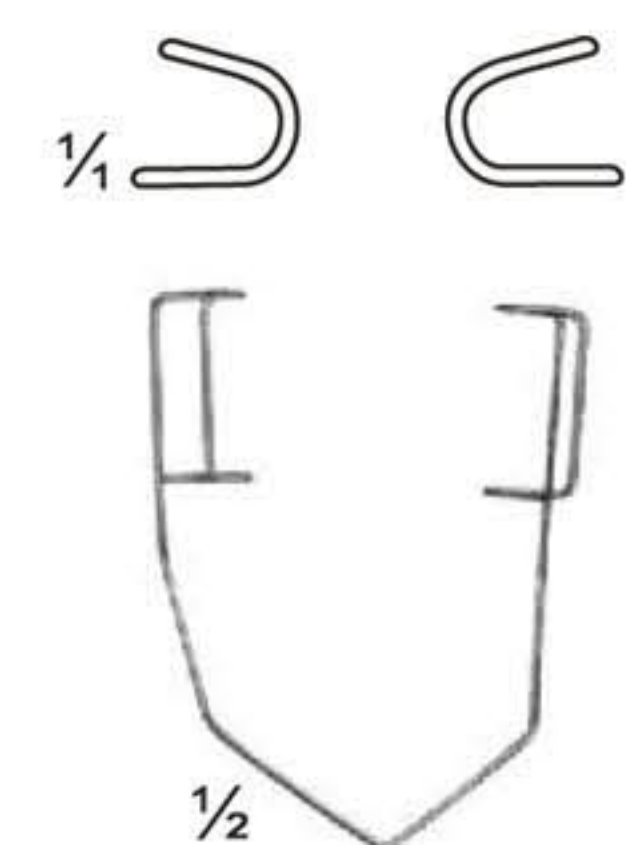

**08-436**  
BARRAQUER  
45 mm



## Self-Retaining Retractors

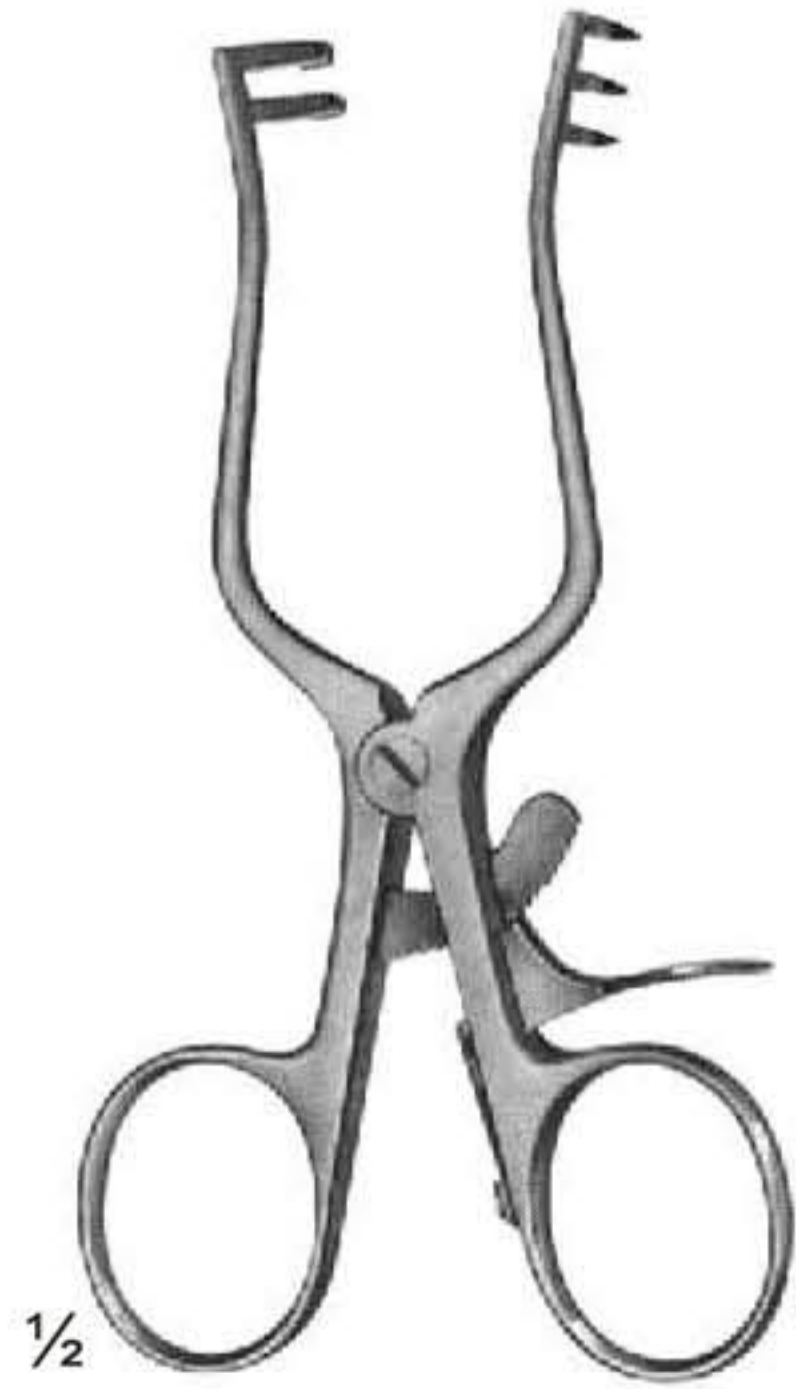

**08-437**  
WEITLANER  
Sharp  
110 mm



**08-438**  
WEITLANER  
Semi-Sharp  
110 mm



**08-439**  
WEITLANER  
Blunt  
110 mm



**08-440**  
WEITLANER  
Sharp  
130 mm



**08-441**  
WEITLANER  
Semi-Sharp  
130 mm

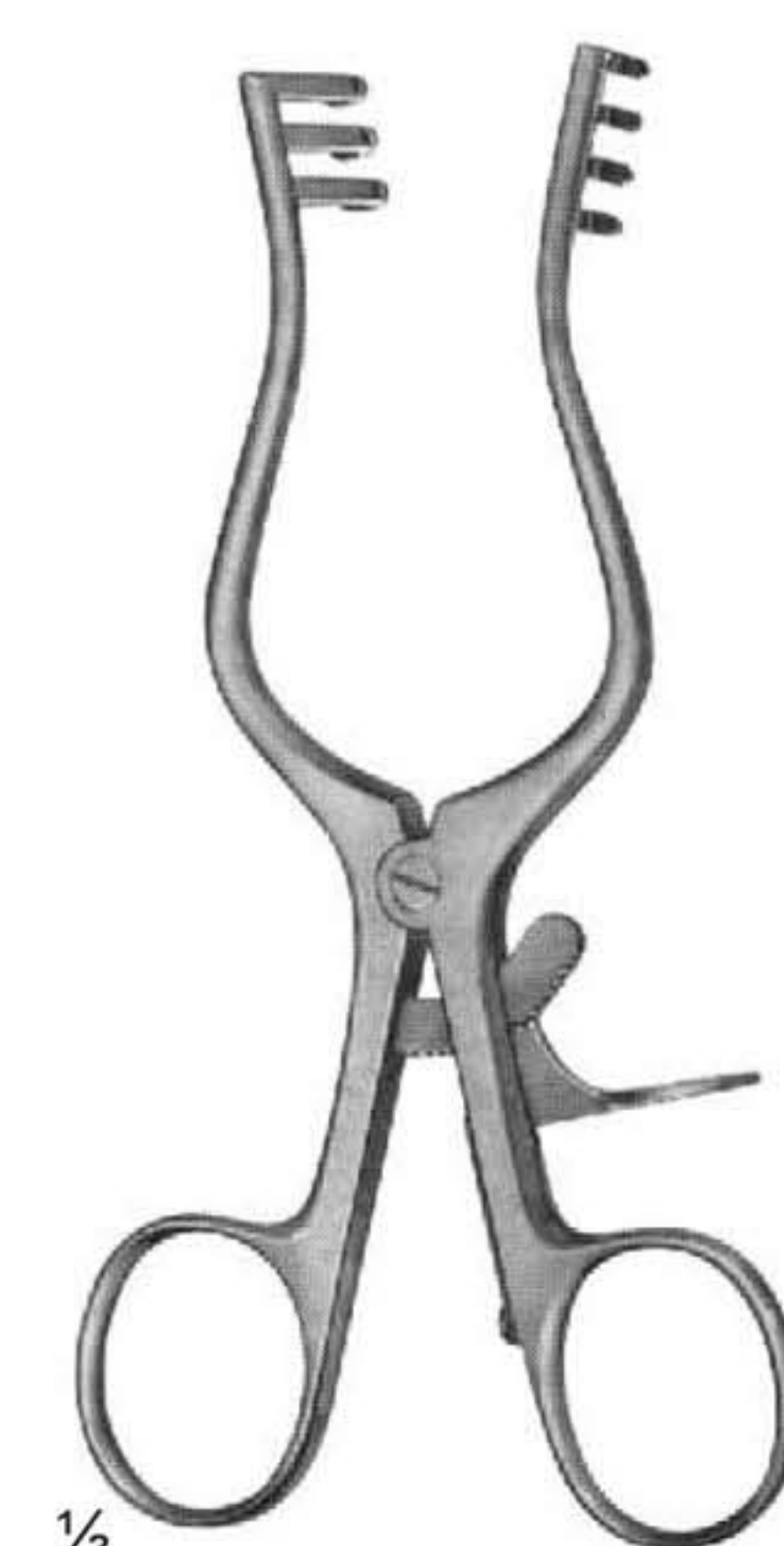

**08-442**  
WEITLANER  
Blunt  
130 mm



## Self-Retaining Retractors

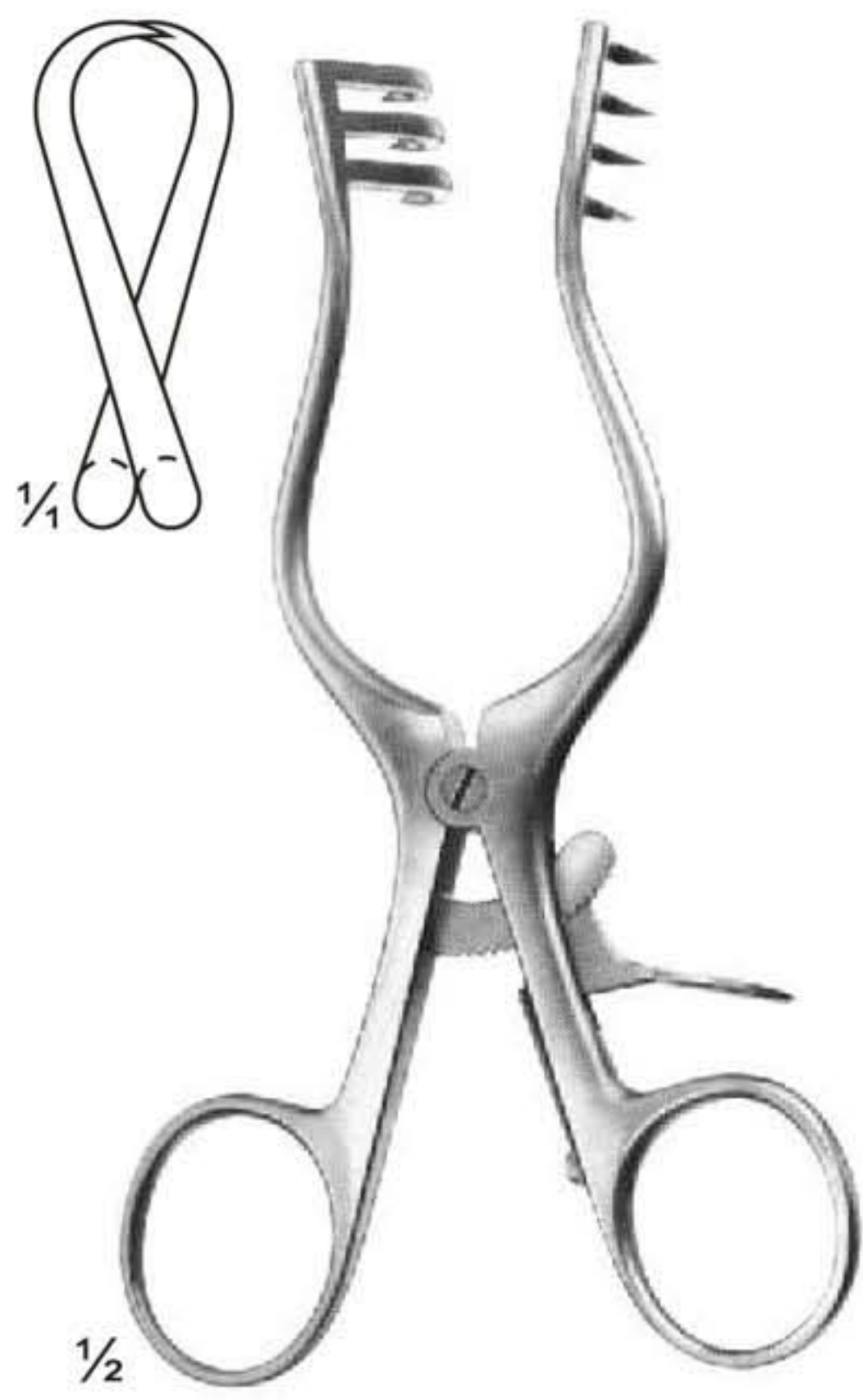

**08-443**  
WEITLANER  
Sharp  
130 mm

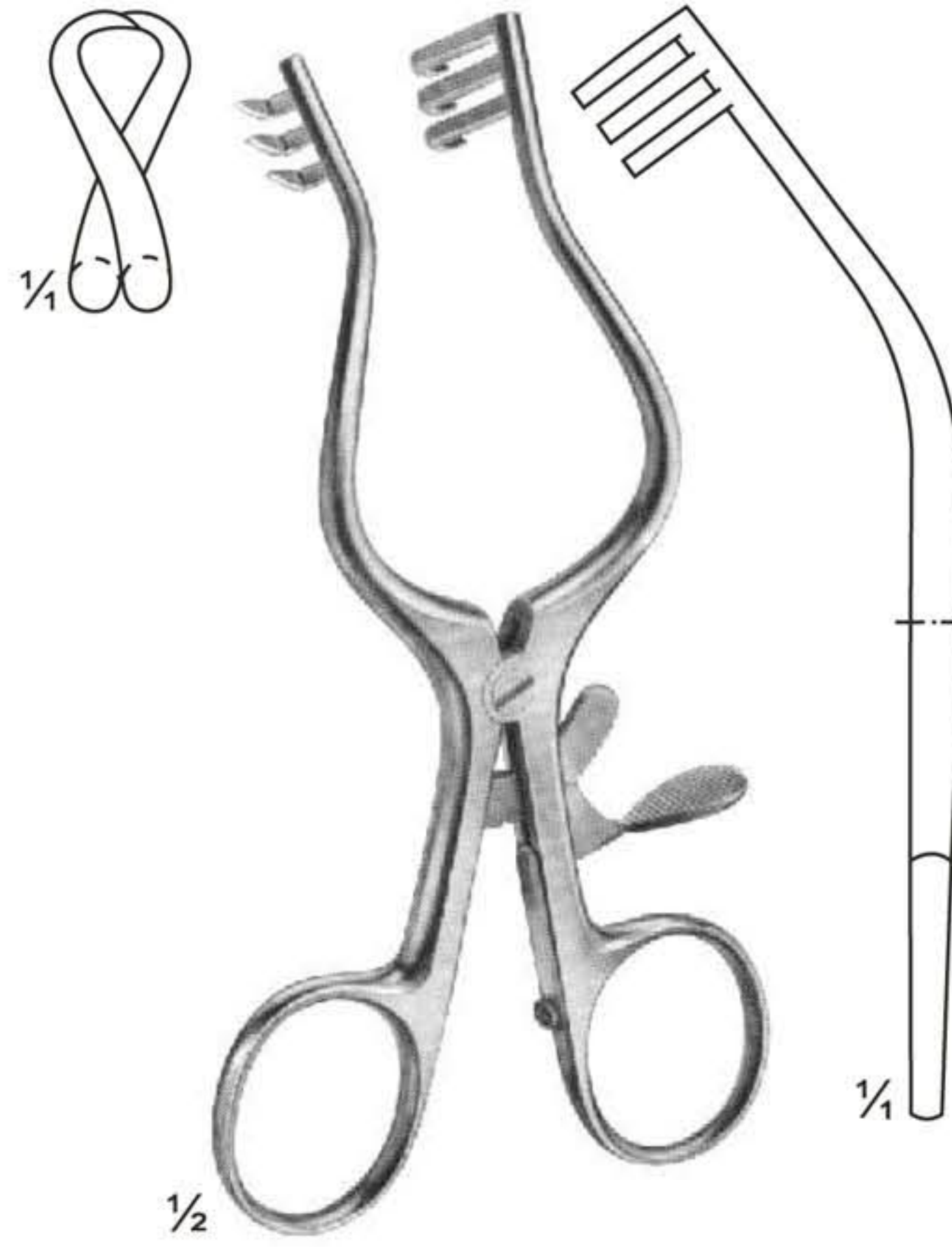

**08-444**  
WULLSTEIN  
Sharp  
130 mm

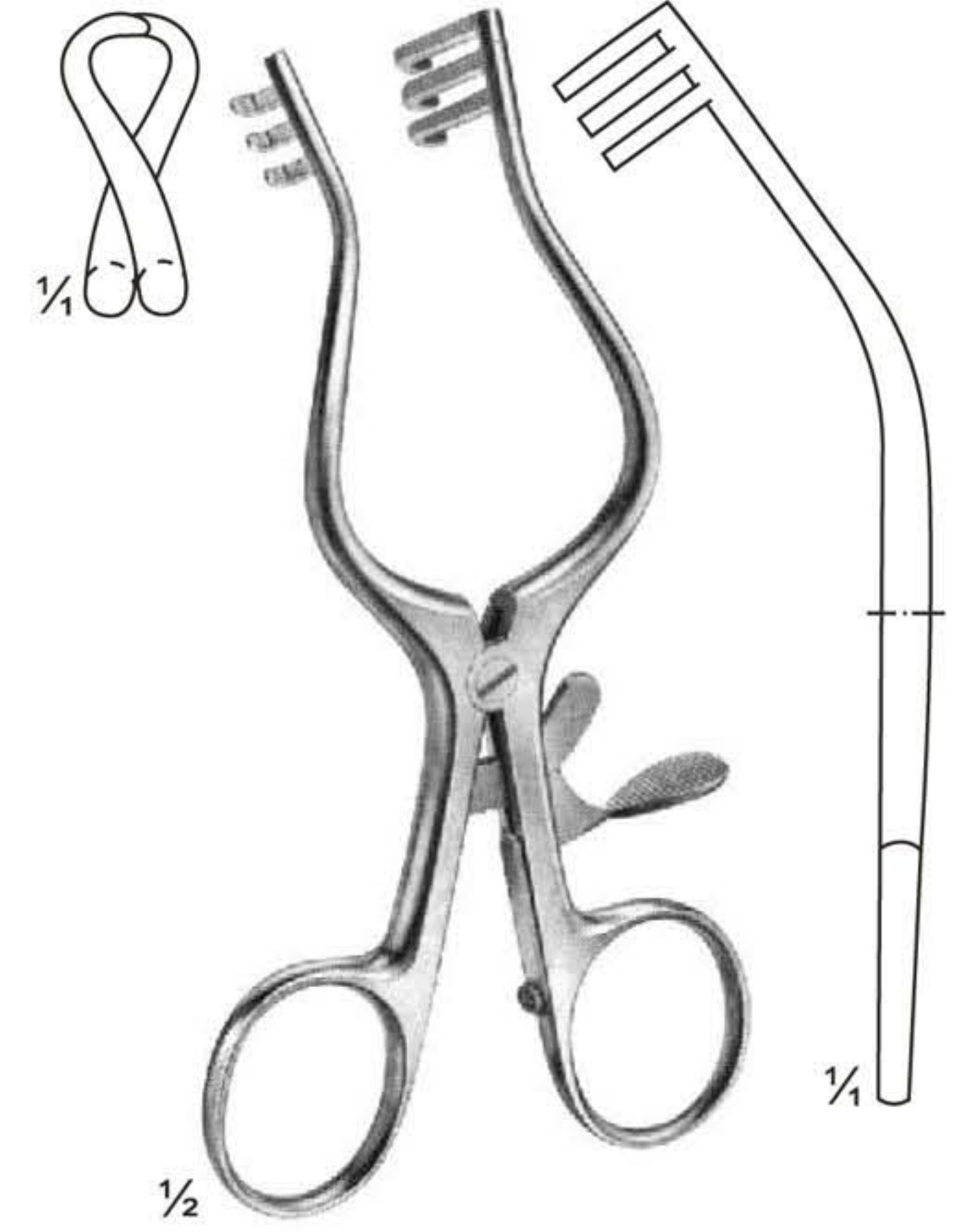

**08-445**  
WULLSTEIN  
Blunt  
130 mm

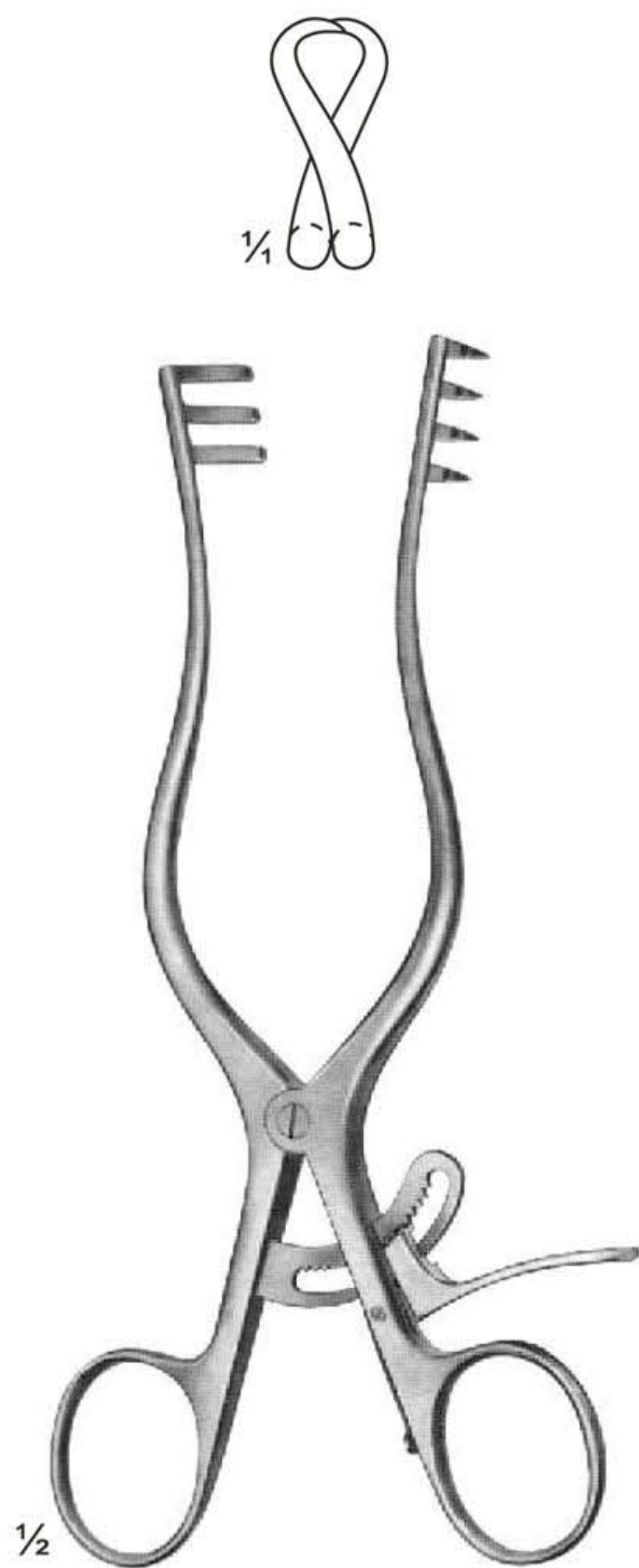

**08-446**  
WEITLANER  
Sharp  
165 mm



**08-447**  
PLESTER  
Blunt  
110 mm

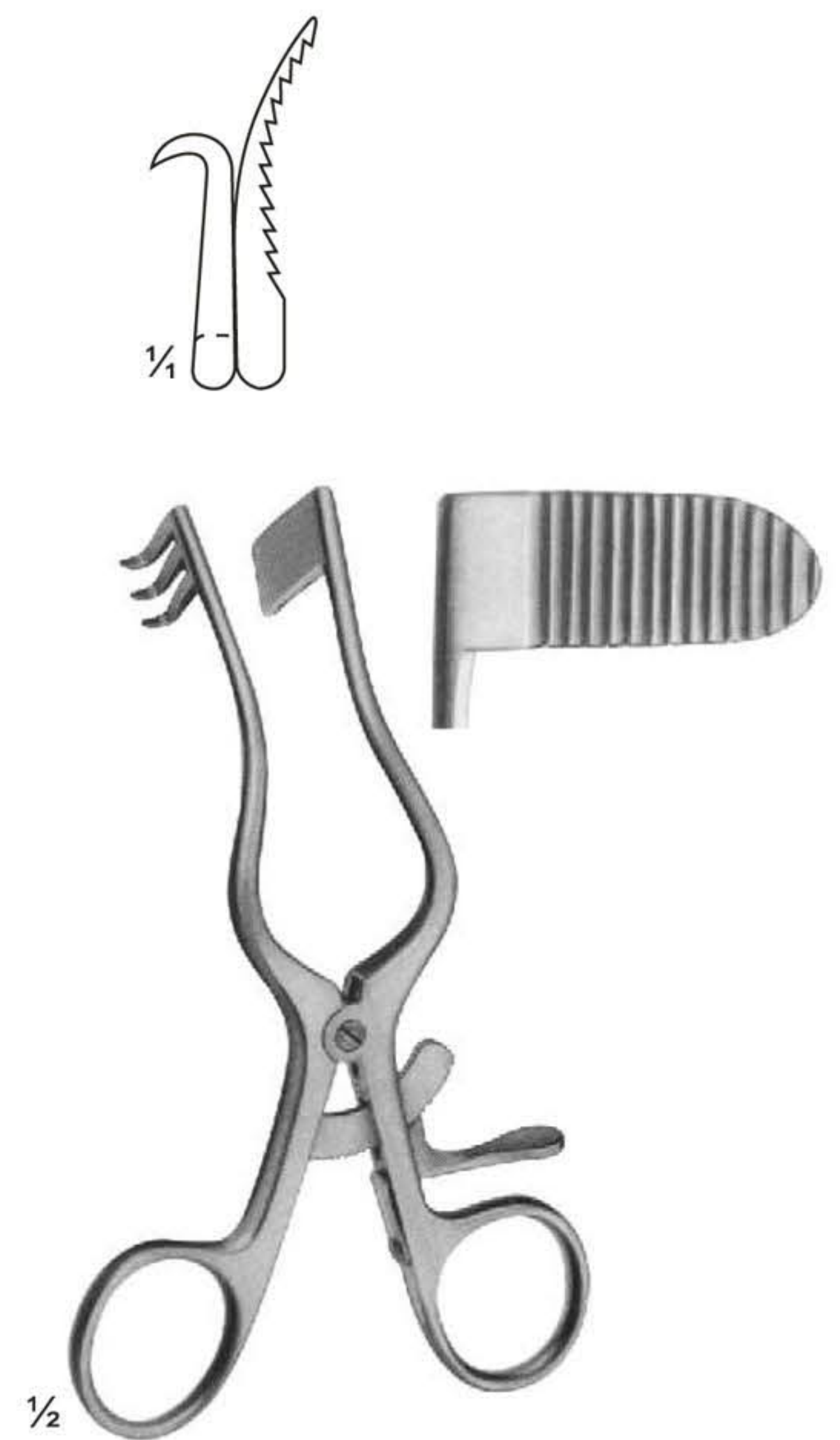

**08-448**  
PERKINS  
130 mm



## Self-Retaining Retractors



**08-449**  
ADSON-BABY  
Blunt  
140 mm

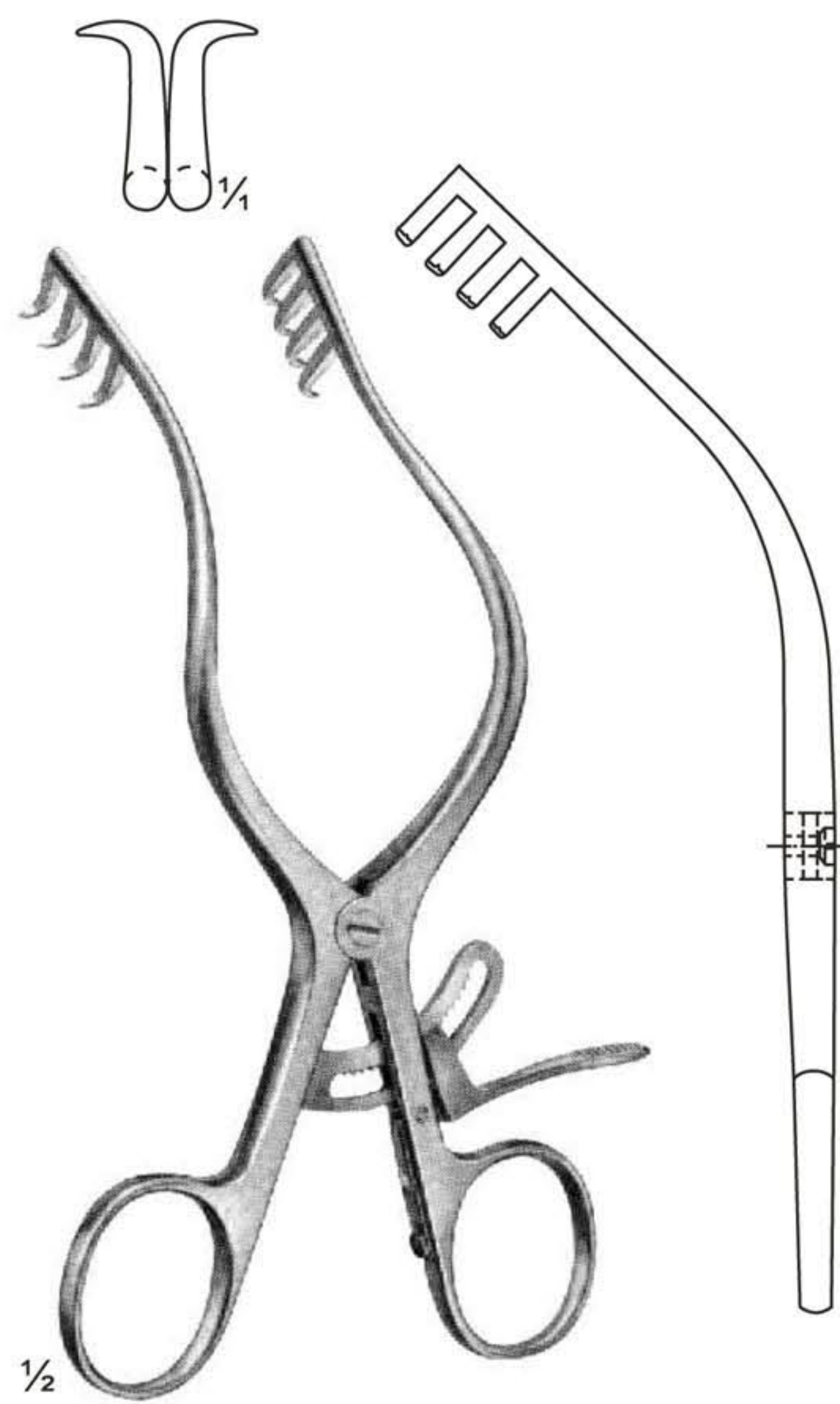

**08-450**  
MOLLISON  
Sharp  
155 mm

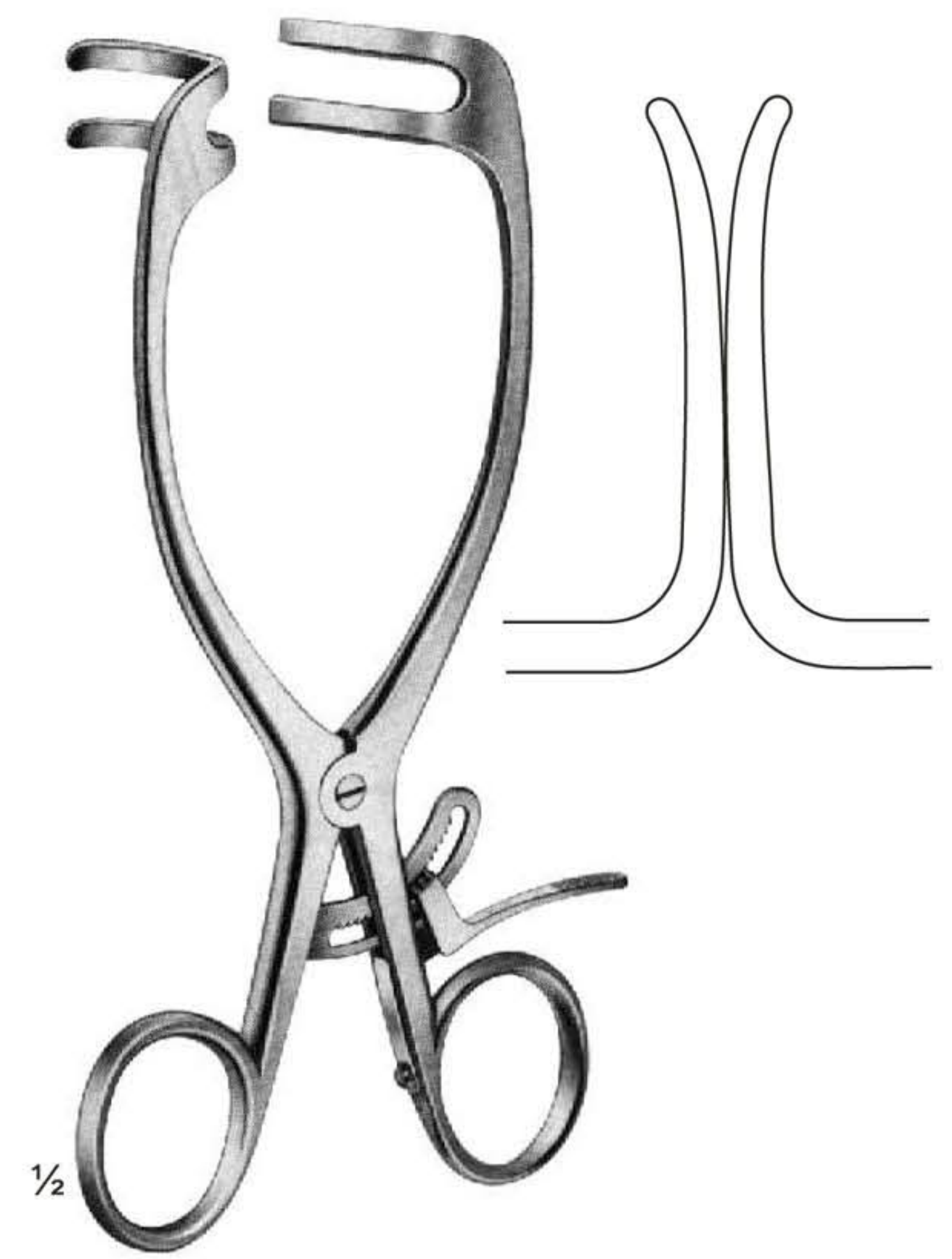

**08-451**  
MAYO-ADAMS  
165 mm



## Self-Retaining Laminectomy Retractors

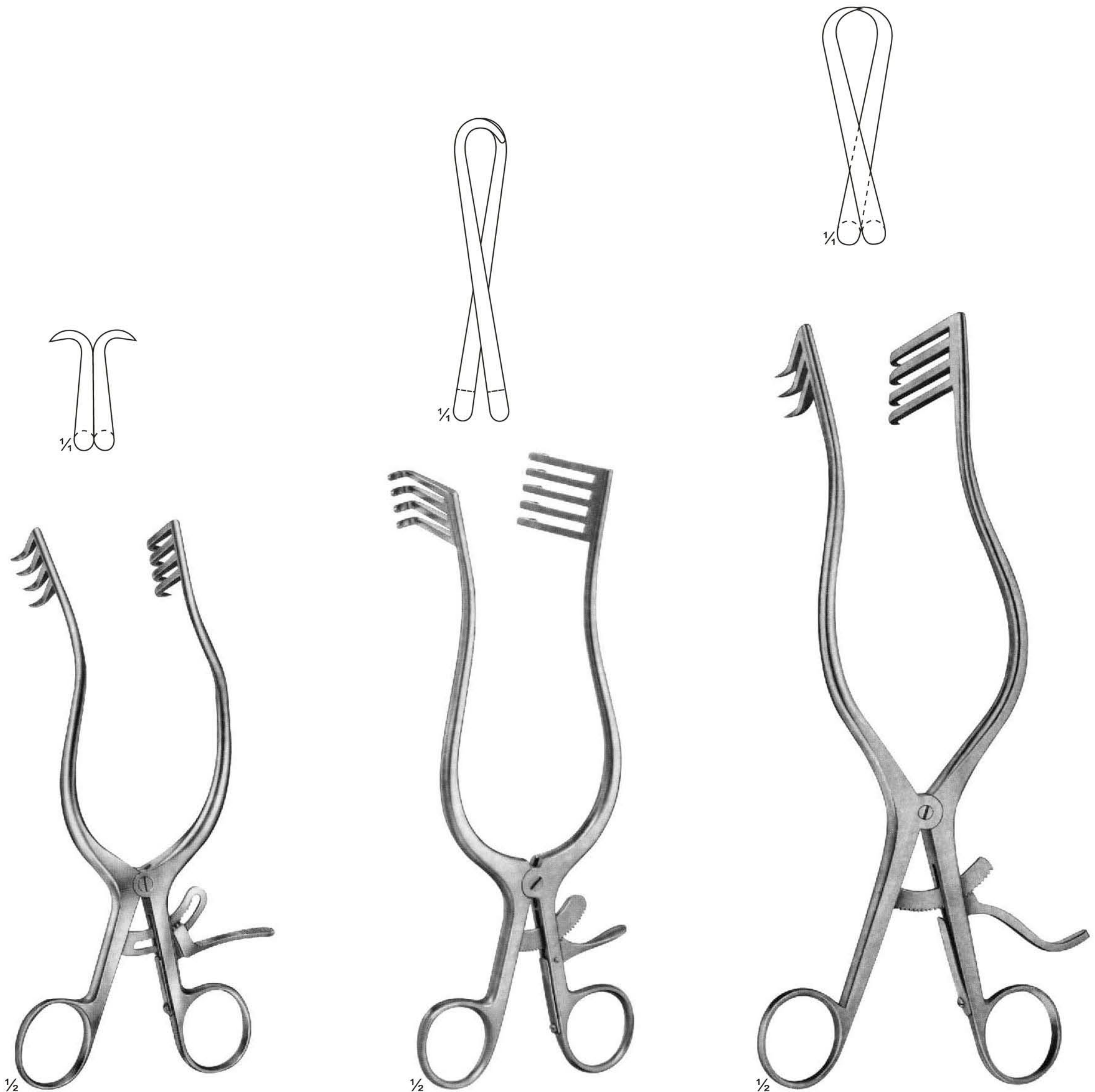

**08-452**  
ANDERSON-ADSON  
Sharp  
190 mm

**08-453**  
NORFOLK and  
NORWICH  
Blunt  
220 mm

**08-454**  
ADSON  
Sharp  
265 mm



# Self-Retaining Laminectomy Retractors

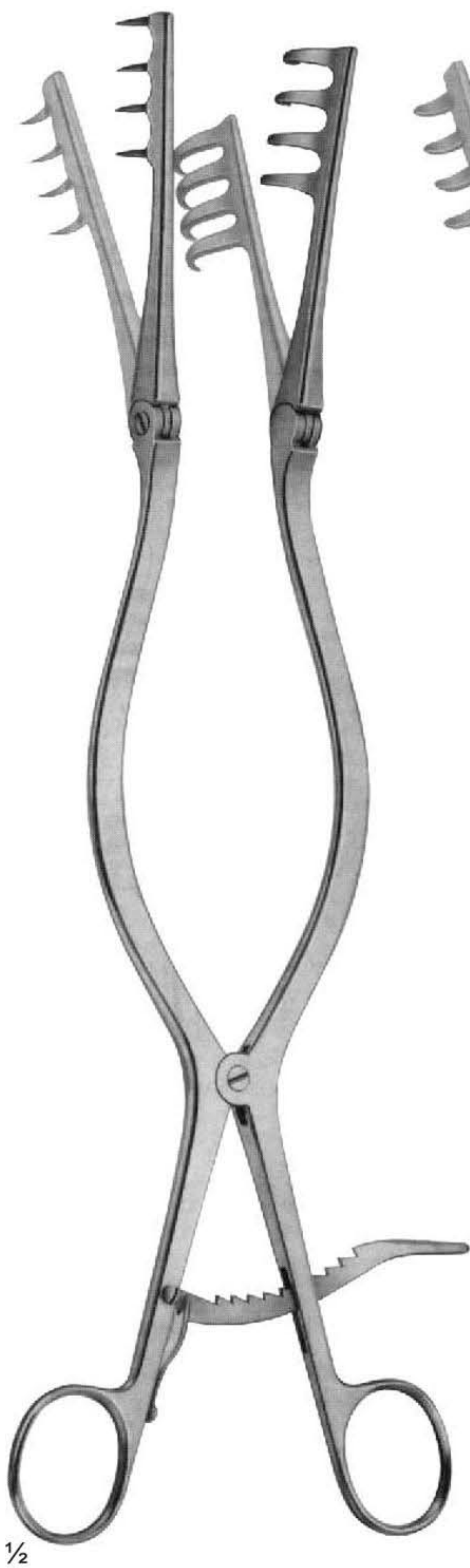
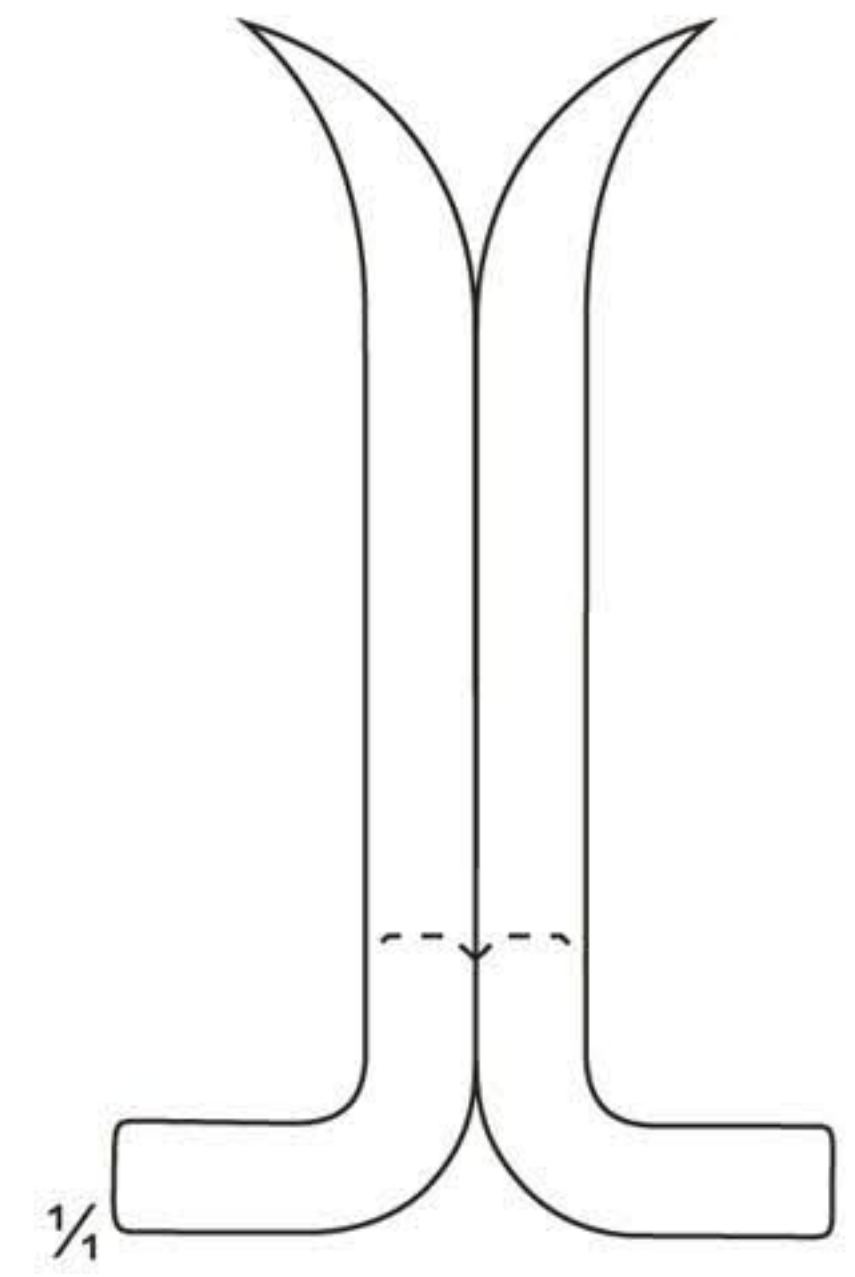
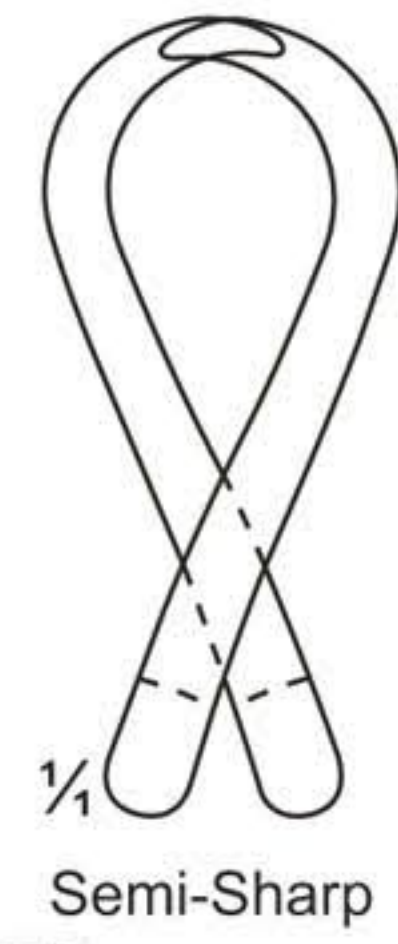
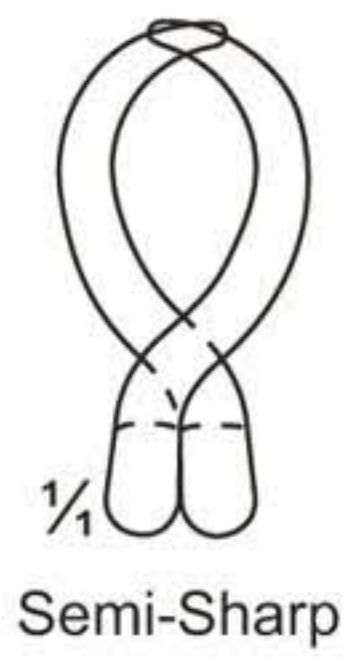
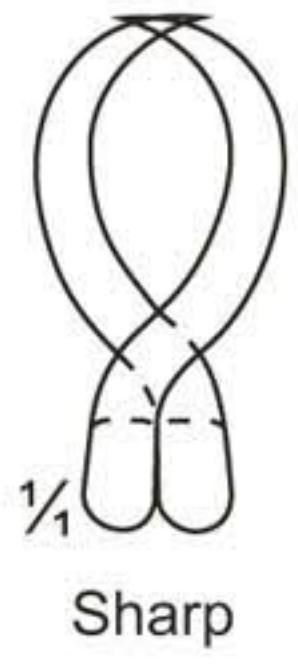

**08-455 - 456**  
BECKMANN-ADSON  
Sharp  
310 mm



**08-456**  
BECKMANN-ADSON  
Semi-Sharp  
310 mm



**08-457**  
ADSON  
Semi-Sharp  
320 mm



**08-458**  
BECKMANN-EATON  
Sharp  
320 mm



Special Retractors



1/2

**08-459**  
JOLL ( FRIEDMAN )  
Thyroid- and Vaginal Retractor  
155 mm

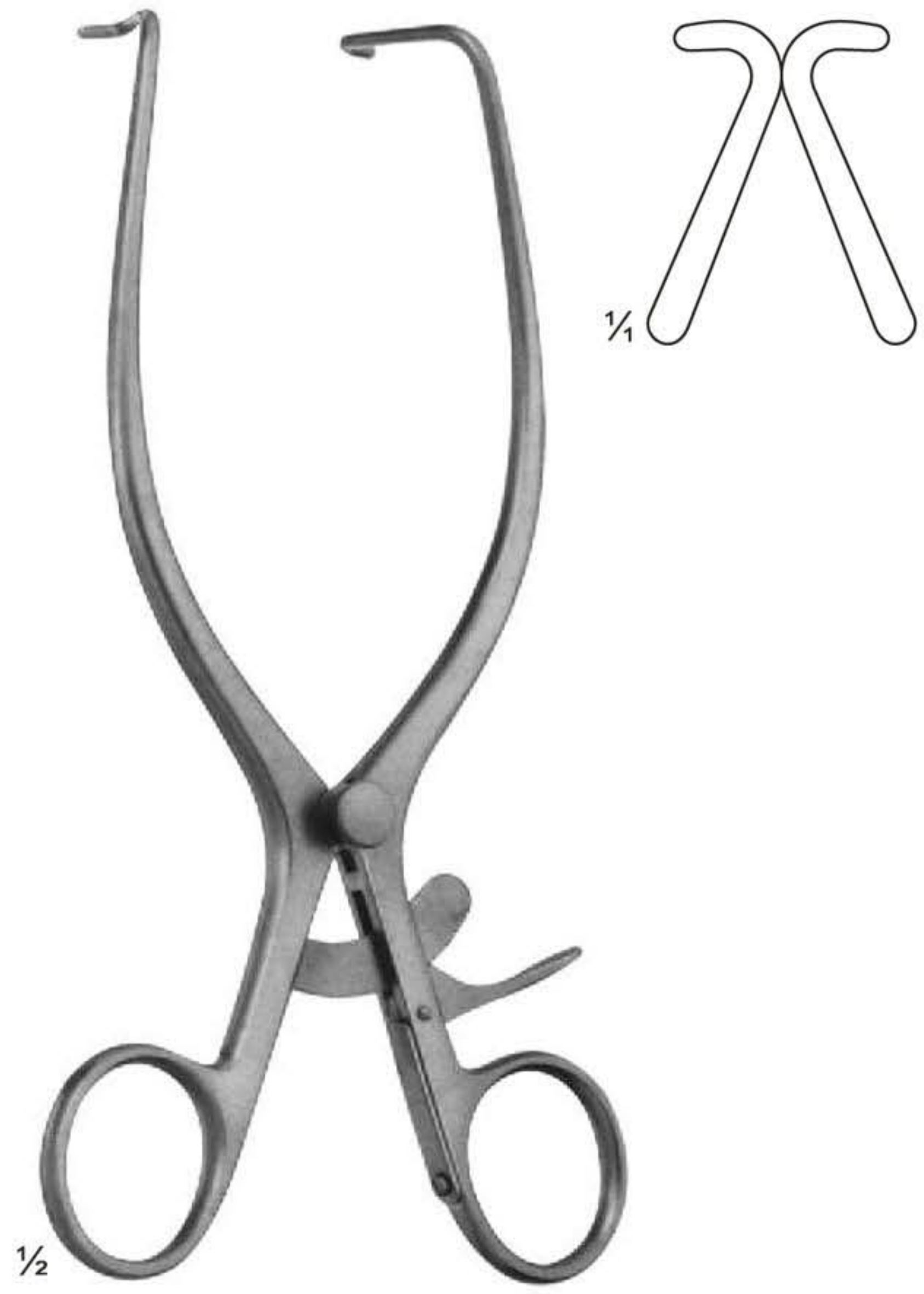

1/2

**08-460**  
JACKSON BURROWS  
Retractor, blunt  
185 mm

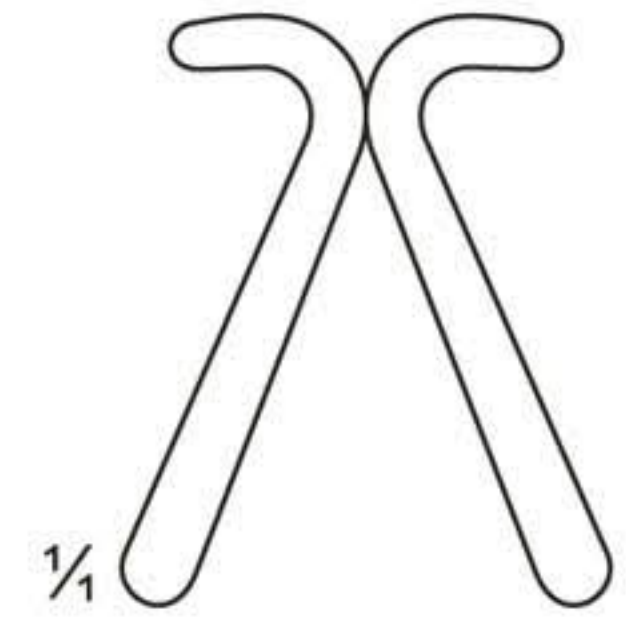

1/4

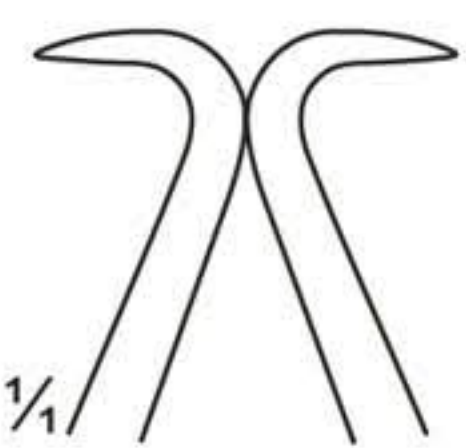

1/4



1/2

**08-461**  
GELPI  
Vaginal Retractor  
135 mm

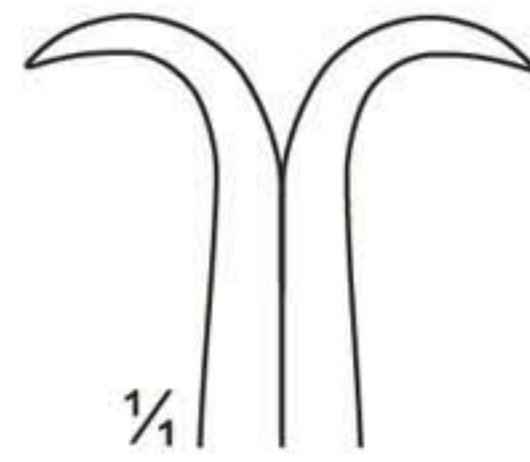

1/4



1/2

**08-462**  
GELPI  
Skin- and Vaginal Retractor  
175 mm

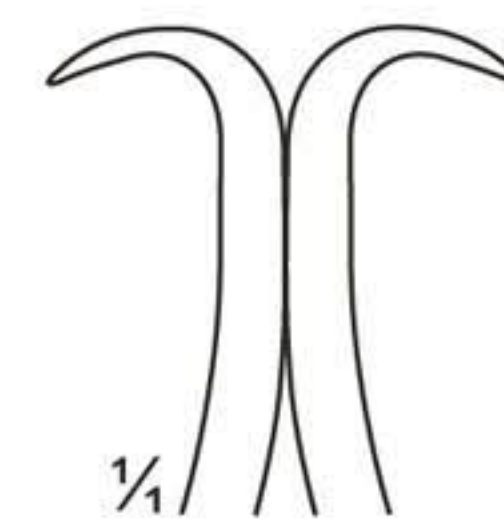

1/4



1/2

**08-463**  
DE BAKEY  
Femur Retractor  
145 mm



## Self Retaining Retractors for Laminectomy and other Operations

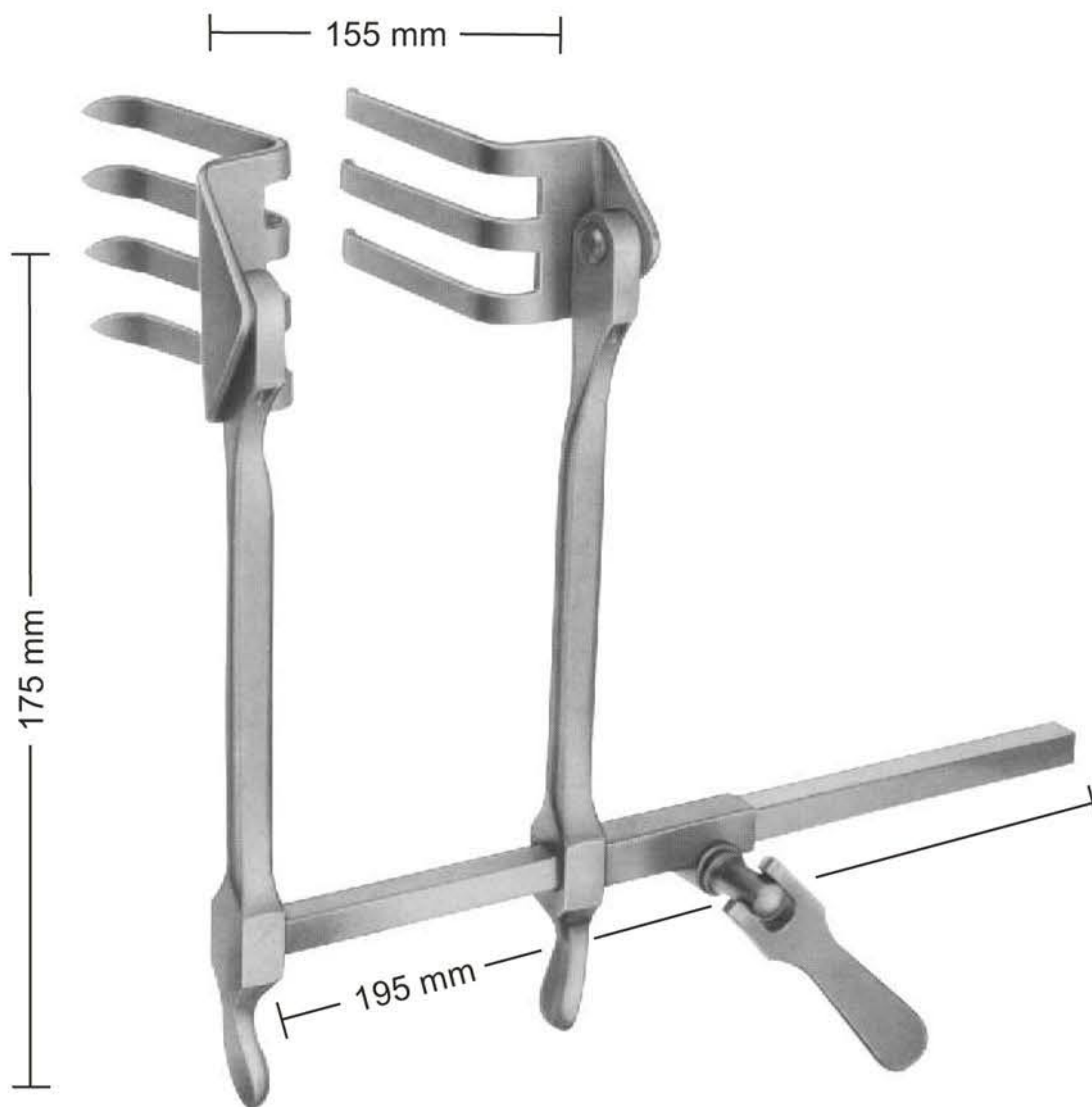

**08-464 - 468**  
SCOVILLE-RICHTER  
Retractor with 1 pair  
blades reversible type.  
The Retractor bar and  
shanks may be easily  
rotated 180° when  
blades are in situ.



**08-465**  
62 x 52 mm    62 x 37 mm  
PR= Pair



**08-466**  
47 x 51 mm



**08-467**  
30 x 40 mm



**08-468**  
37 x 62 mm



**Retractors for Cervical Spine**



**08-469**  
CLOWARD modif.  
Spreader Only



16 mm  
**08-470**

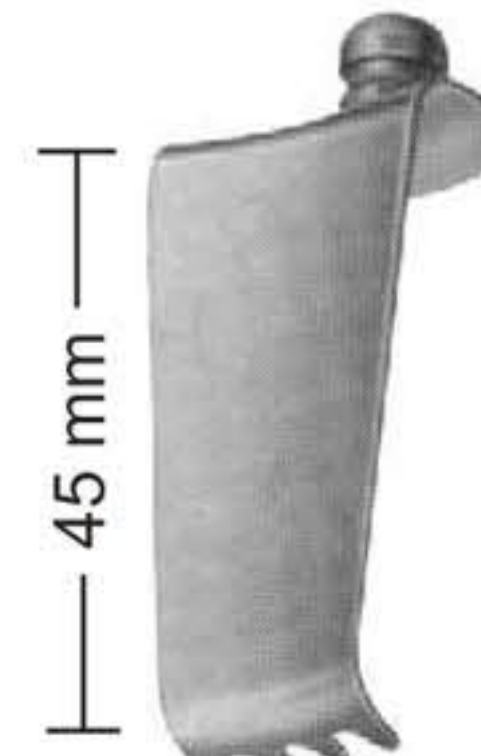

16 mm  
**08-471**



16 mm  
**08-475**



16 mm  
**08-476**

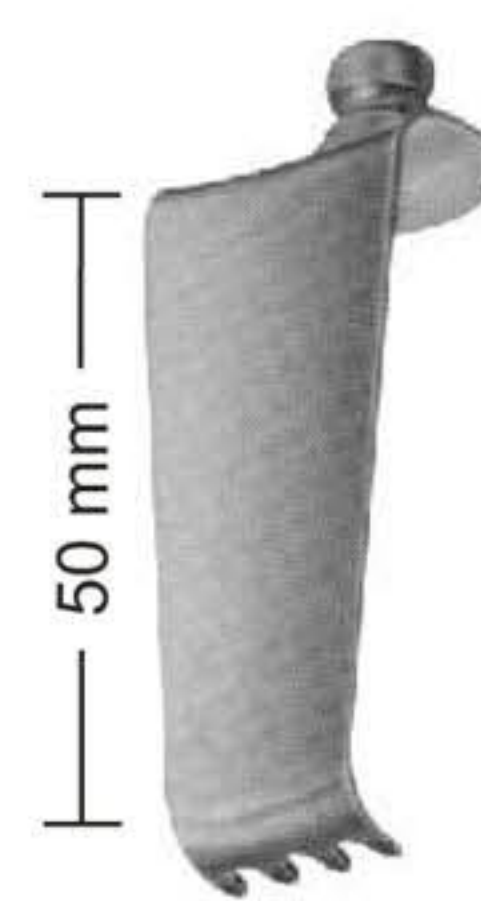

16 mm  
**08-472**

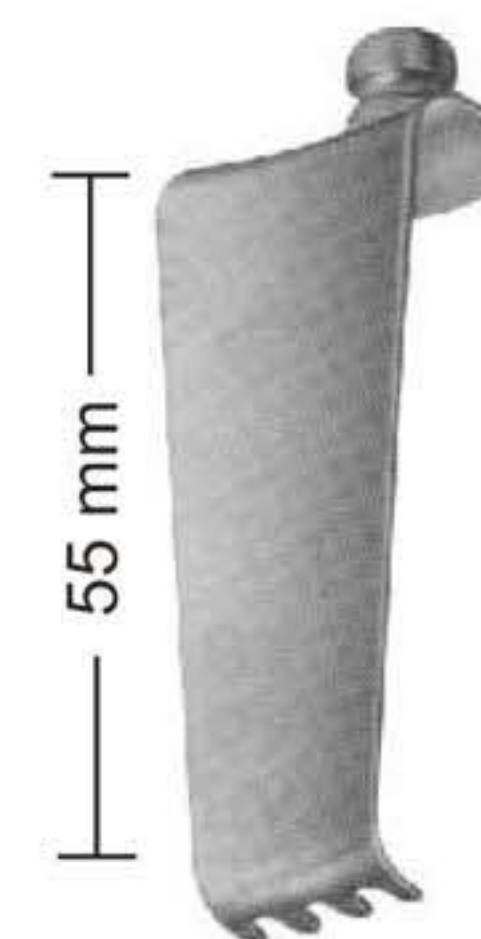

16 mm  
**08-473**

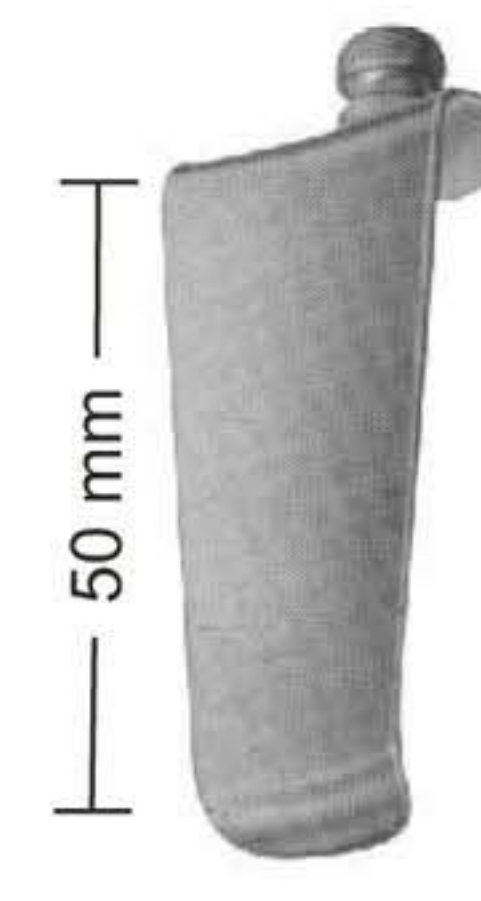

16 mm  
**08-477**

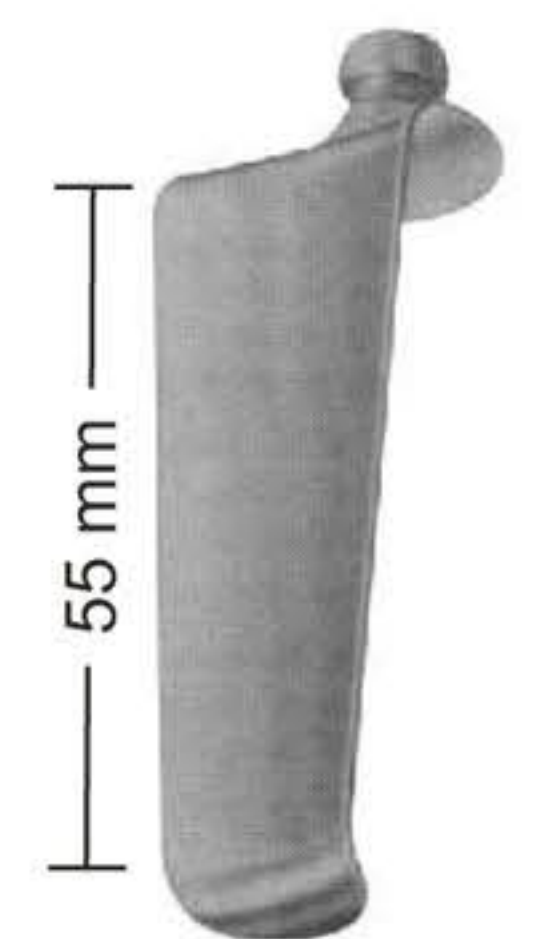

16 mm  
**08-478**

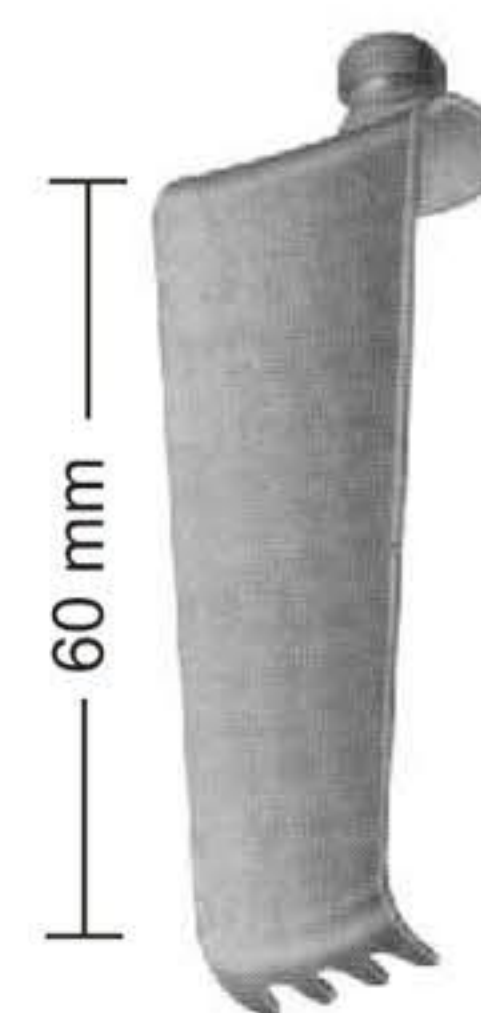

16 mm  
**08-474**

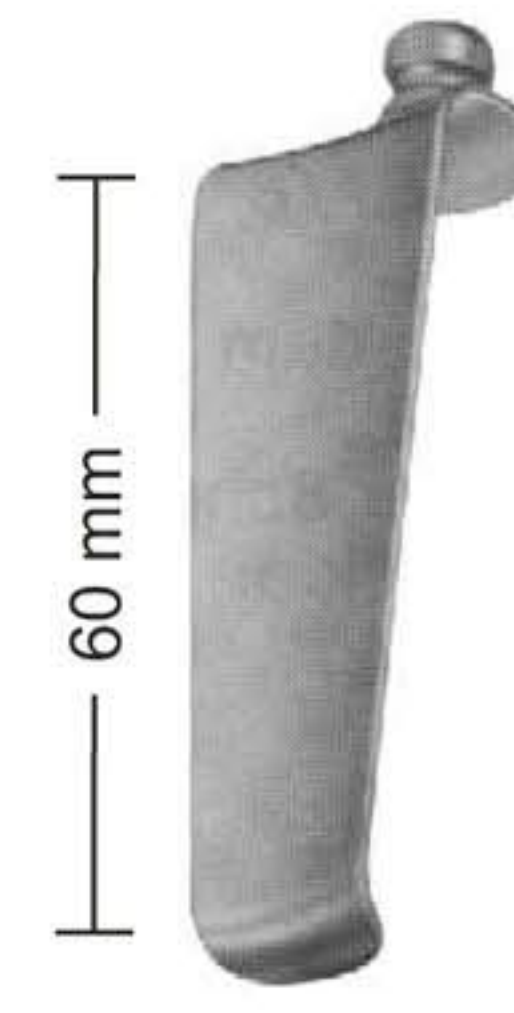

16 mm  
**08-479**

08-470 blade  
08-471 blade  
08-472 blade  
08-473 blade  
08-474 blade

08-475 blade  
08-476 blade  
08-477 blade  
08-478 blade  
08-479 blade



## Retractors for Cervical Vertebral Column

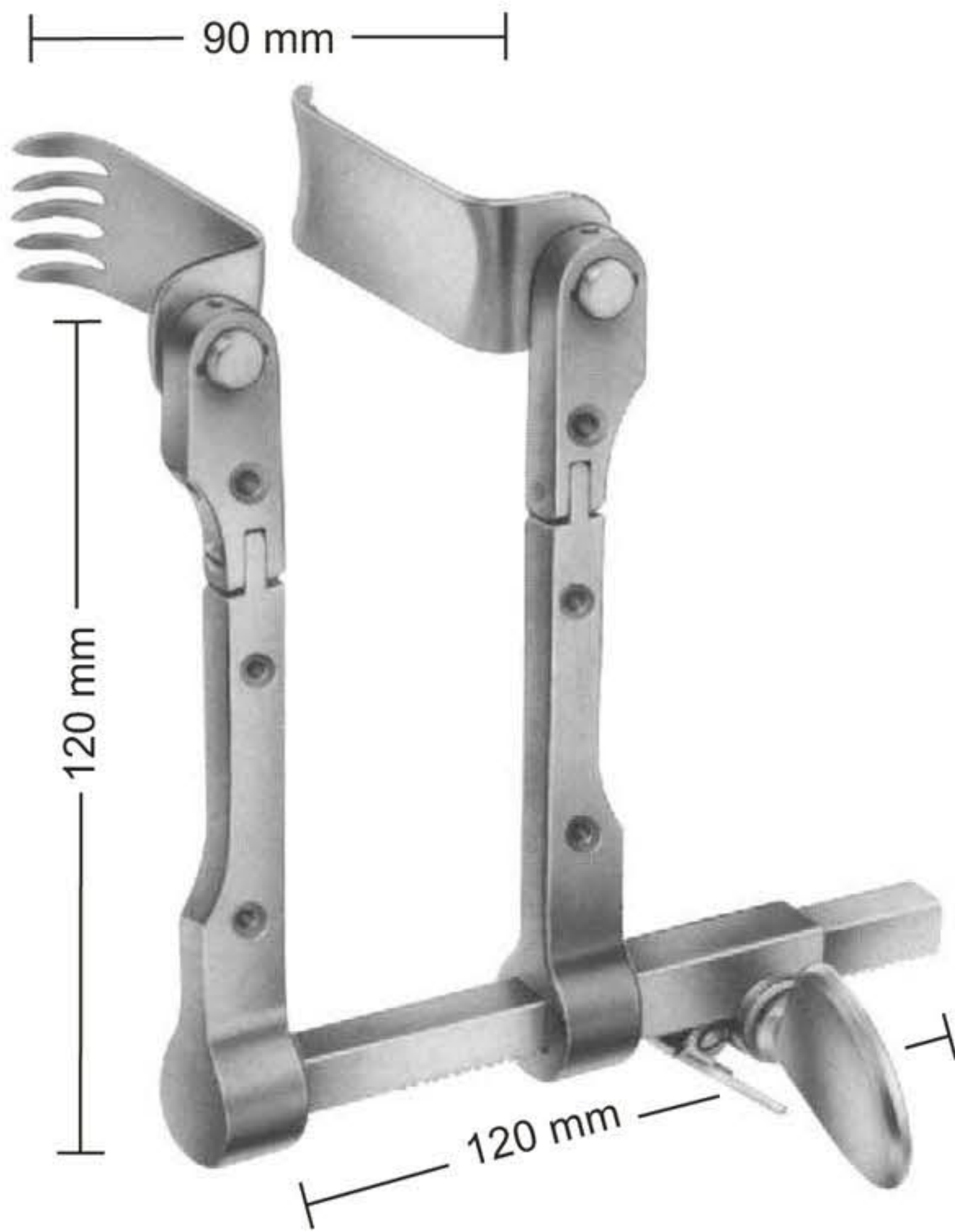

**08-480**  
CASPAR  
Retractor, adjustable,  
consisting of: 5 medial  
blades, 5 Lateral blades.

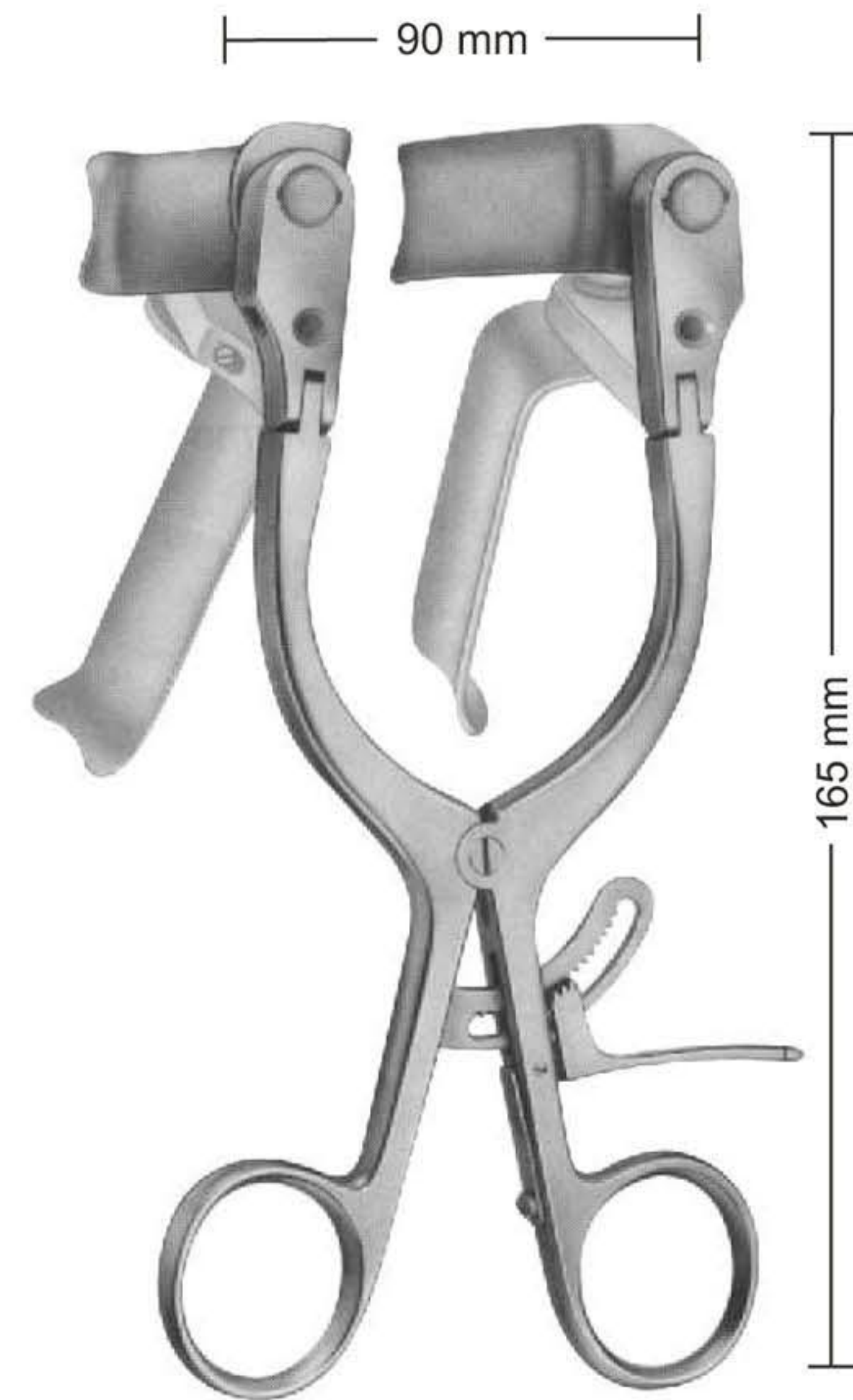

**08-480 A**  
CASPAR  
Counter retractor, adjustable,  
consisting of: 5 blades.



**08-481** 40 x 23 mm  
**08-482** 45 x 23 mm  
**08-483** 50 x 23 mm  
**08-484** 55 x 23 mm  
**08-485** 60 x 23 mm  
Medial blades



**08-486** 40 x 23 mm  
**08-487** 45 x 23 mm  
**08-488** 50 x 23 mm  
**08-489** 55 x 23 mm  
**08-490** 60 x 23 mm  
Lateral blades



**08-491** 45 x 23 mm  
**08-492** 50 x 23 mm  
**08-493** 55 x 23 mm  
**08-494** 60 x 23 mm  
**08-495** 65 x 23 mm  
Blunt blades



**08-496** 50 x 25 mm  
**08-497** 60 x 25 mm  
Blunt blades,  
for harvesting of the  
fusion graft from the  
iliac crest



**08-498** 40 x 25 mm  
**08-499** 45 x 25 mm  
**08-500** 50 x 25 mm  
**08-501** 55 x 25 mm  
**08-502** 60 x 25 mm  
Medial Titan blades  
semi transparent to x-ray



**08-503** 40 x 25 mm  
**08-504** 45 x 25 mm  
**08-505** 50 x 25 mm  
**08-506** 55 x 25 mm  
**08-507** 60 x 25 mm  
Lateral Titan blades  
semi transparent to x-ray



Lamina Spreaders

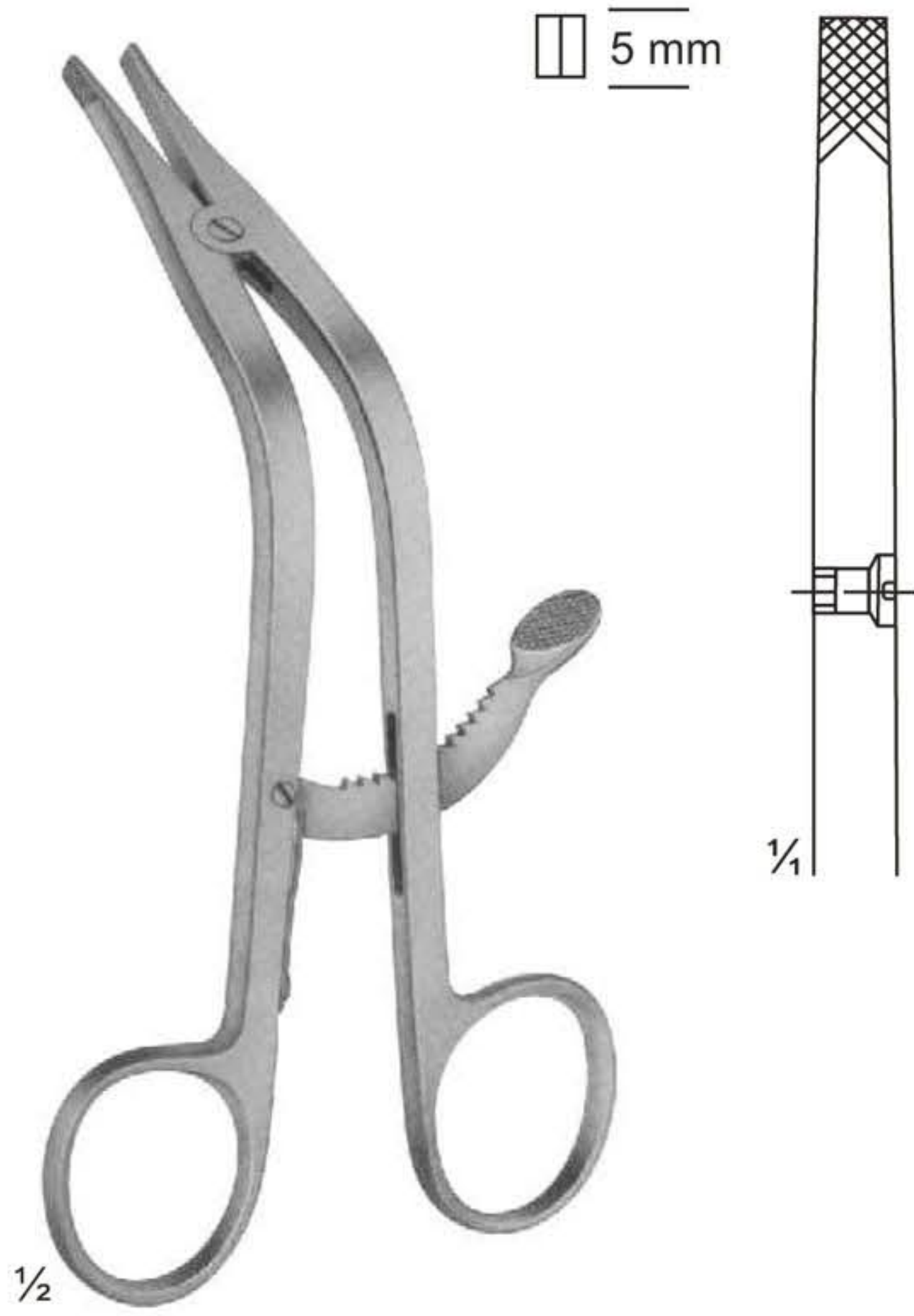

**08-508**  
CLOWARD  
155 mm



**08-509**  
CLOWARD  
135 mm

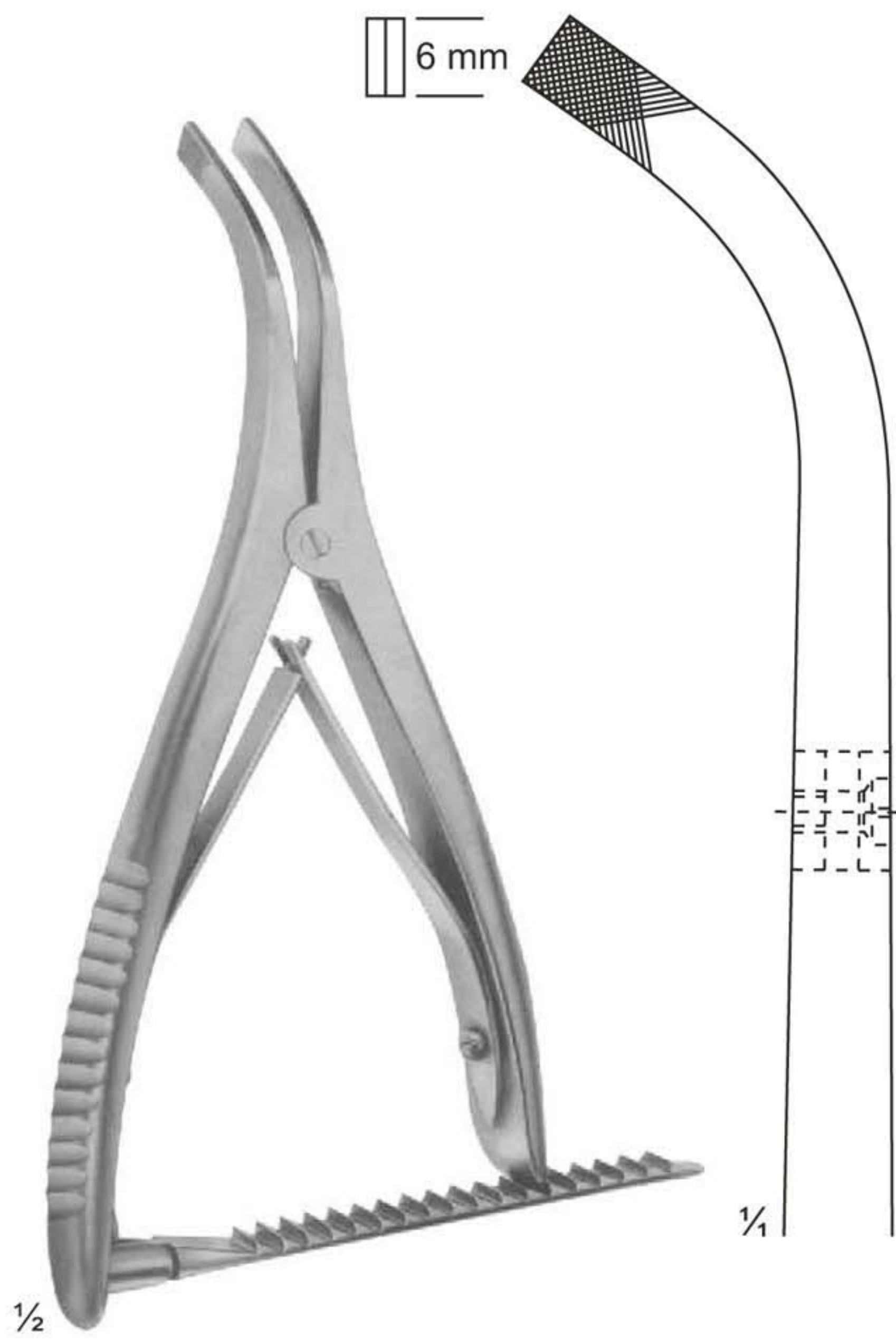

**08-510**  
INGE  
170 mm

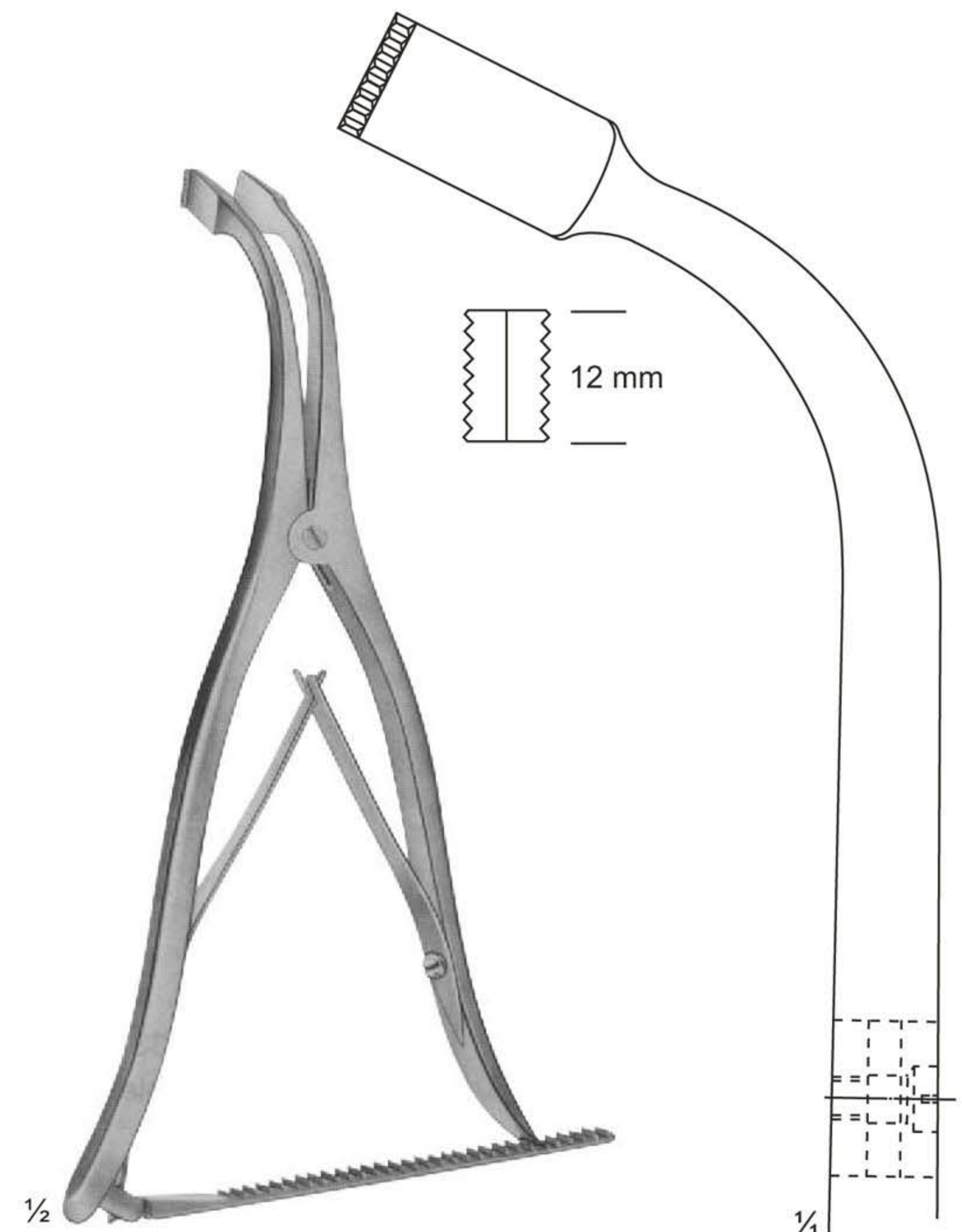

**08-511**  
INGE  
275 mm



**Abdominal Retractors**

**08-512**  
BABY-COLLIN  
with 2 pair of blades

90 mm  
24 mm  
42 mm

**08-513**  
COLLIN  
complete

135 mm  
37 mm  
62 mm

**08-514 - 518**  
COLLIN  
complete

08-817 135 mm  
08-818 160 mm

08-516  
08-515  
08-514

Spreader only  
Lateral blade  
Canter blade

37x98mm  
37x80mm  
37x62mm

52x76mm  
54x67mm  
54x55mm

**08-519 - 520**  
RICARD  
complete

210 mm

**08-521 - 523**  
HOLZBACH  
Complete

275 mm

08-519  
08-520

Spreader only  
Lateral blade  
Canter blade

58x80mm  
72x84mm  
54x70mm

72x90mm

08-521  
08-522  
08-523

Spreader only  
Lateral blade  
Canter blade

59x80mm  
74x82mm



# Abdominal Baldes

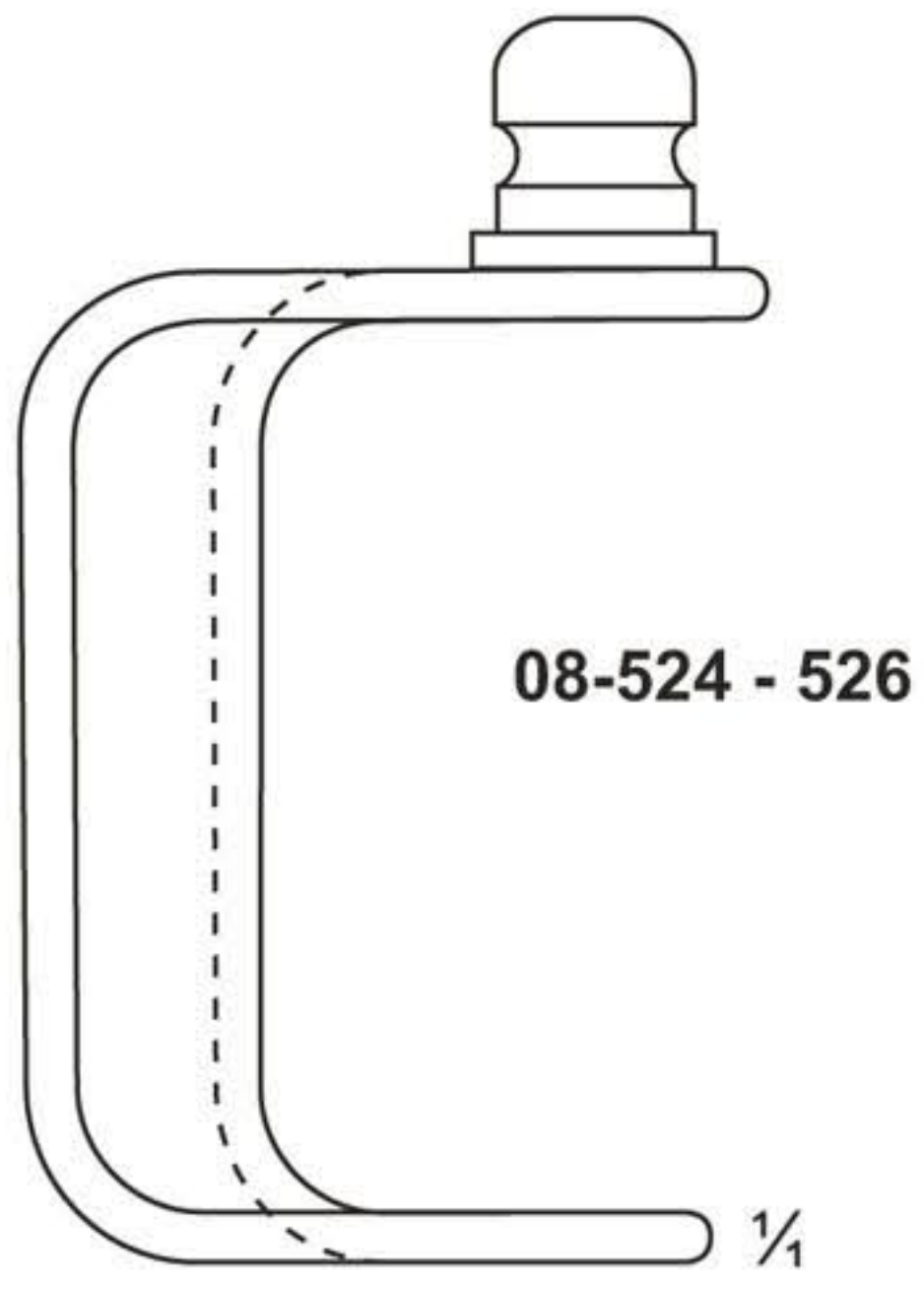

08-524 - 526

Lateral blades only  
**08-524** 37x62 mm  
**08-525** 37x80 mm  
**08-526** 37x98 mm

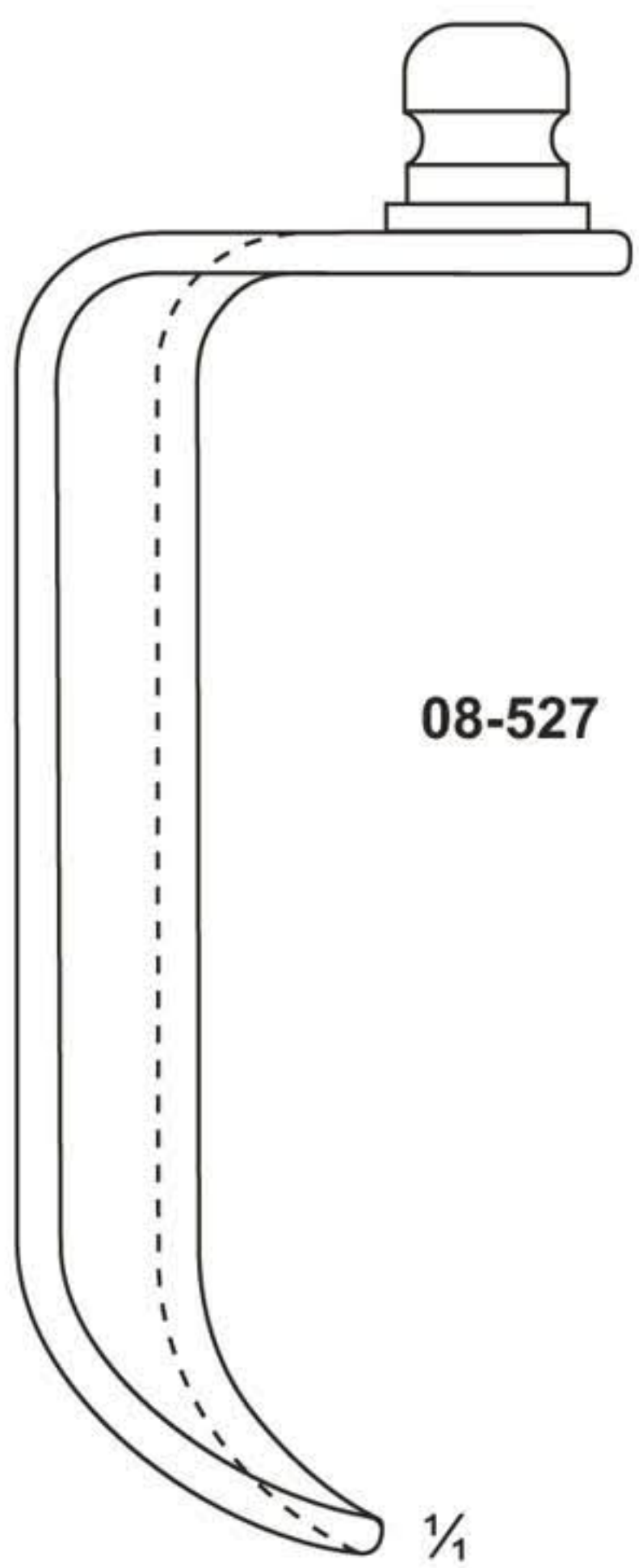

08-527

08-527 61x80 mm

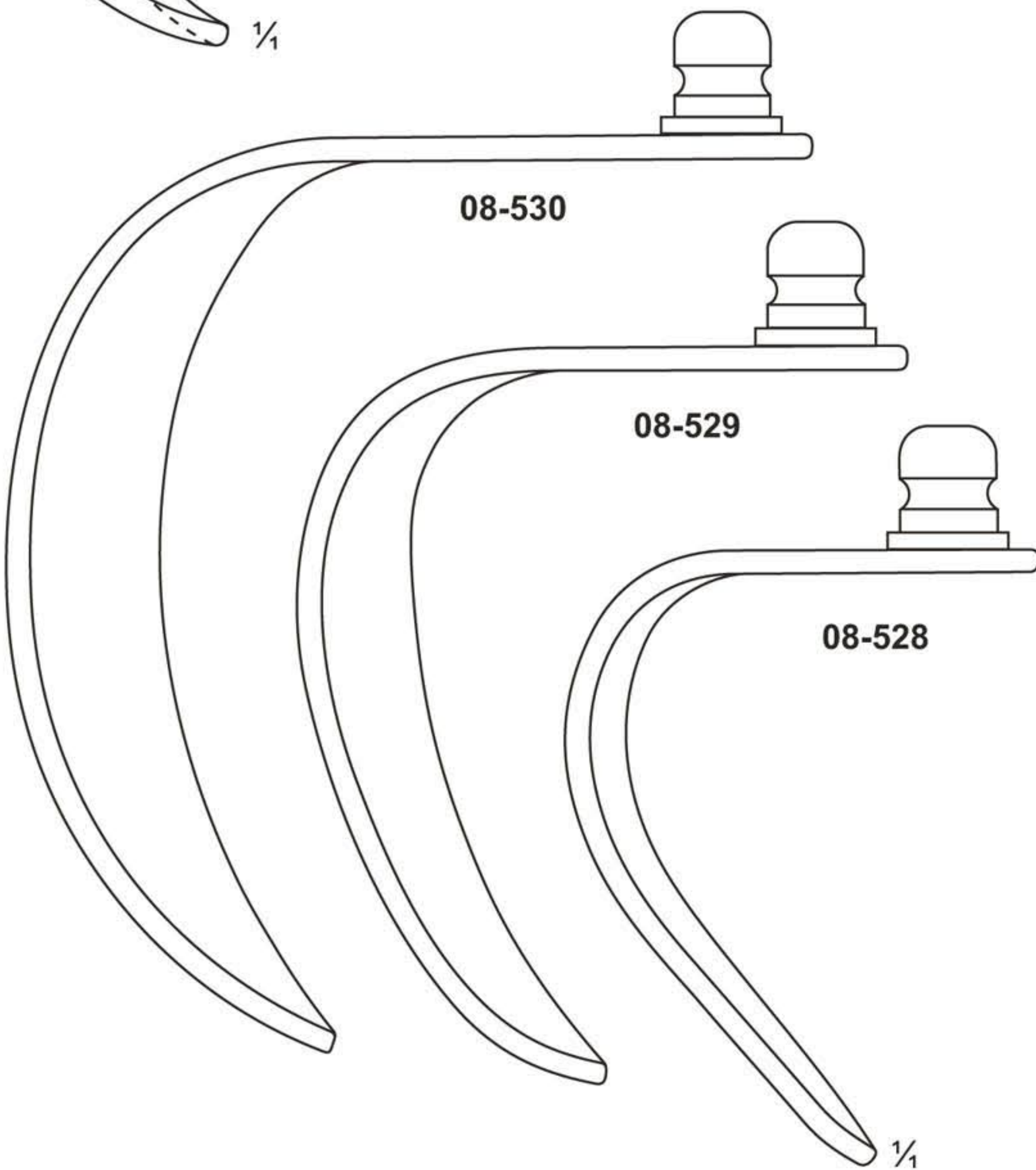

08-530

08-529

08-528

**08-528** 48x59 mm  
**08-529** 58x80 mm  
**08-530** 72x84 mm

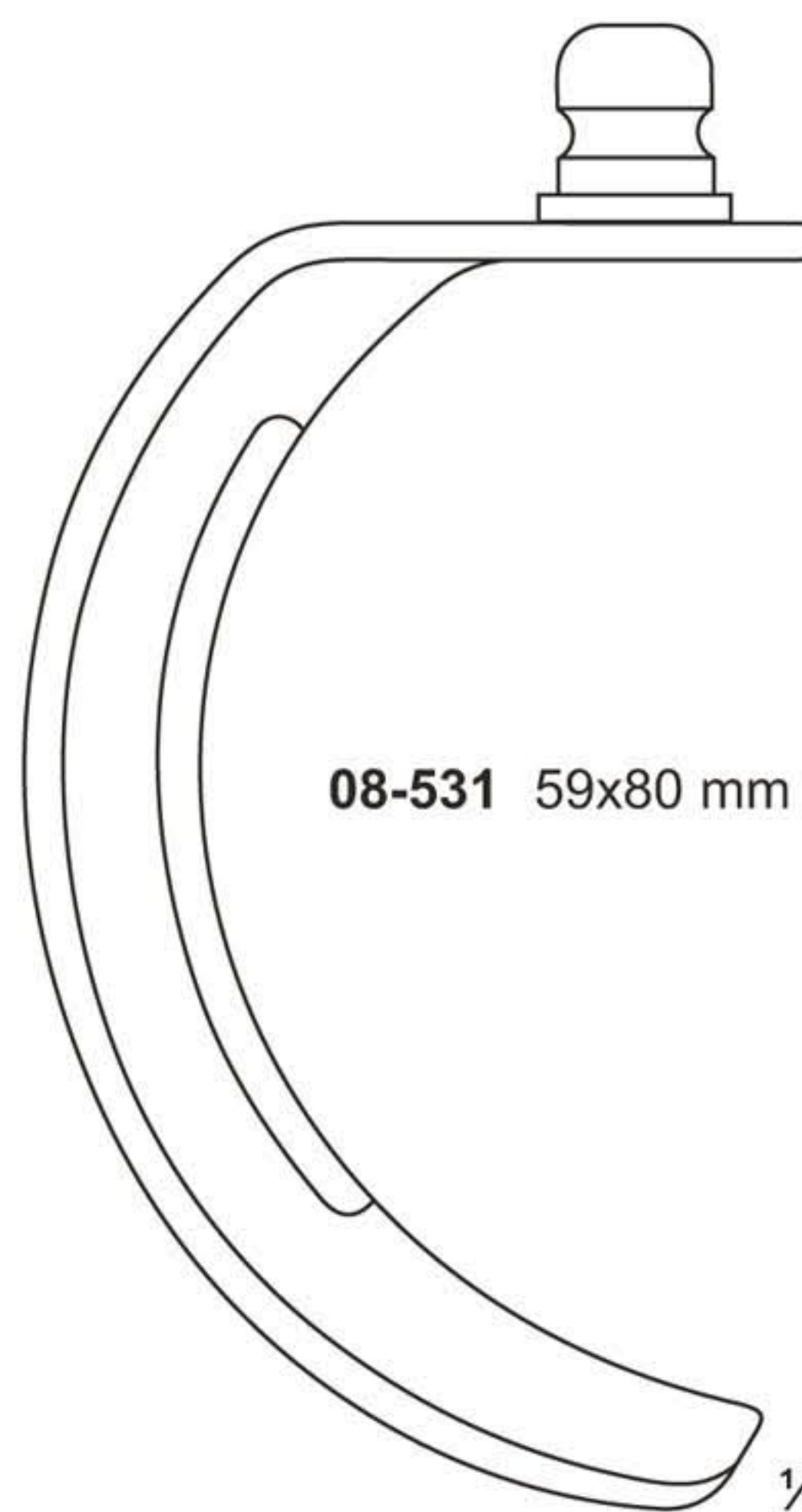

08-531 59x80 mm





# Abdominal Retractors

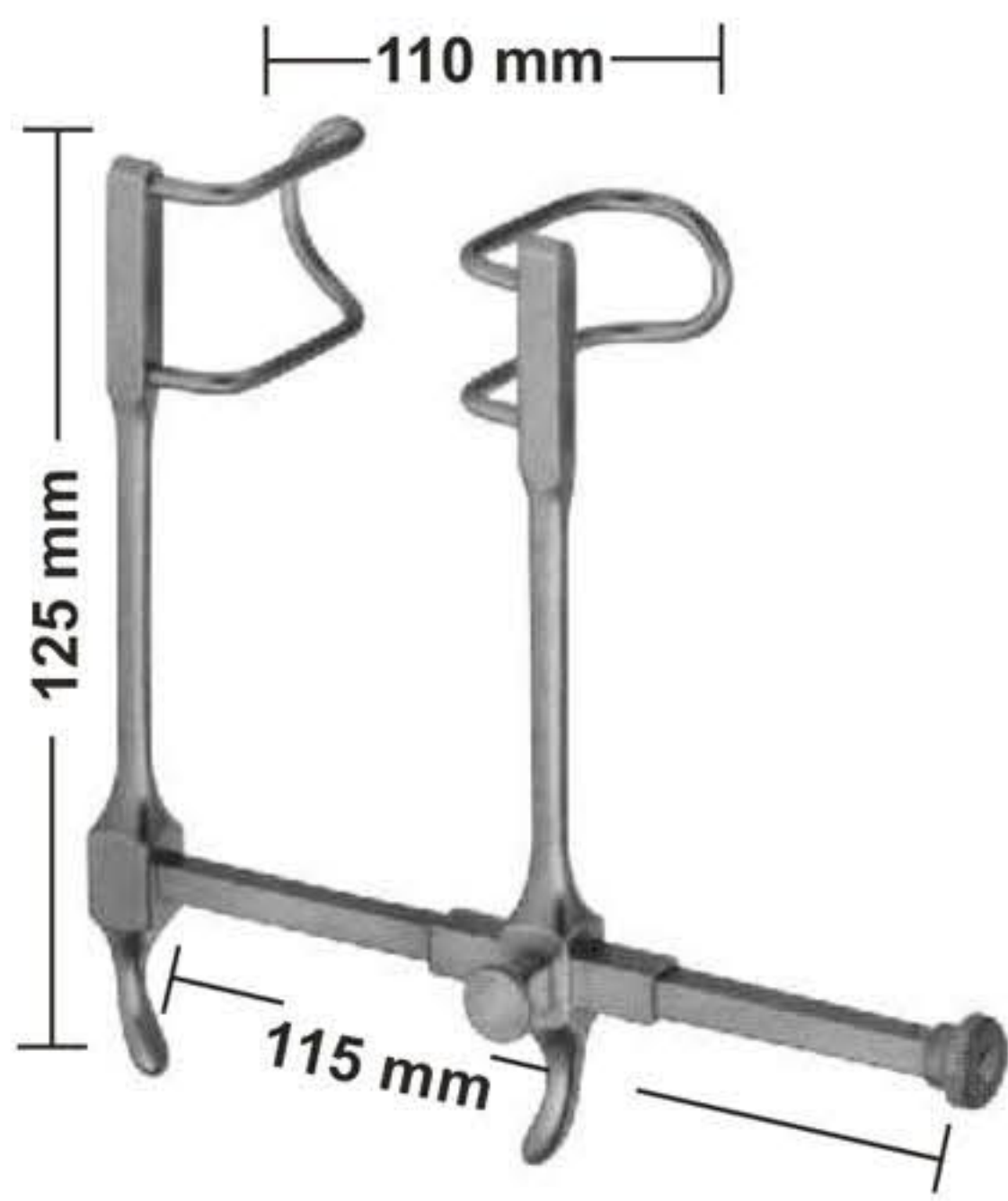

**08-532**  
GOSSET  
Blades:38 mm deep

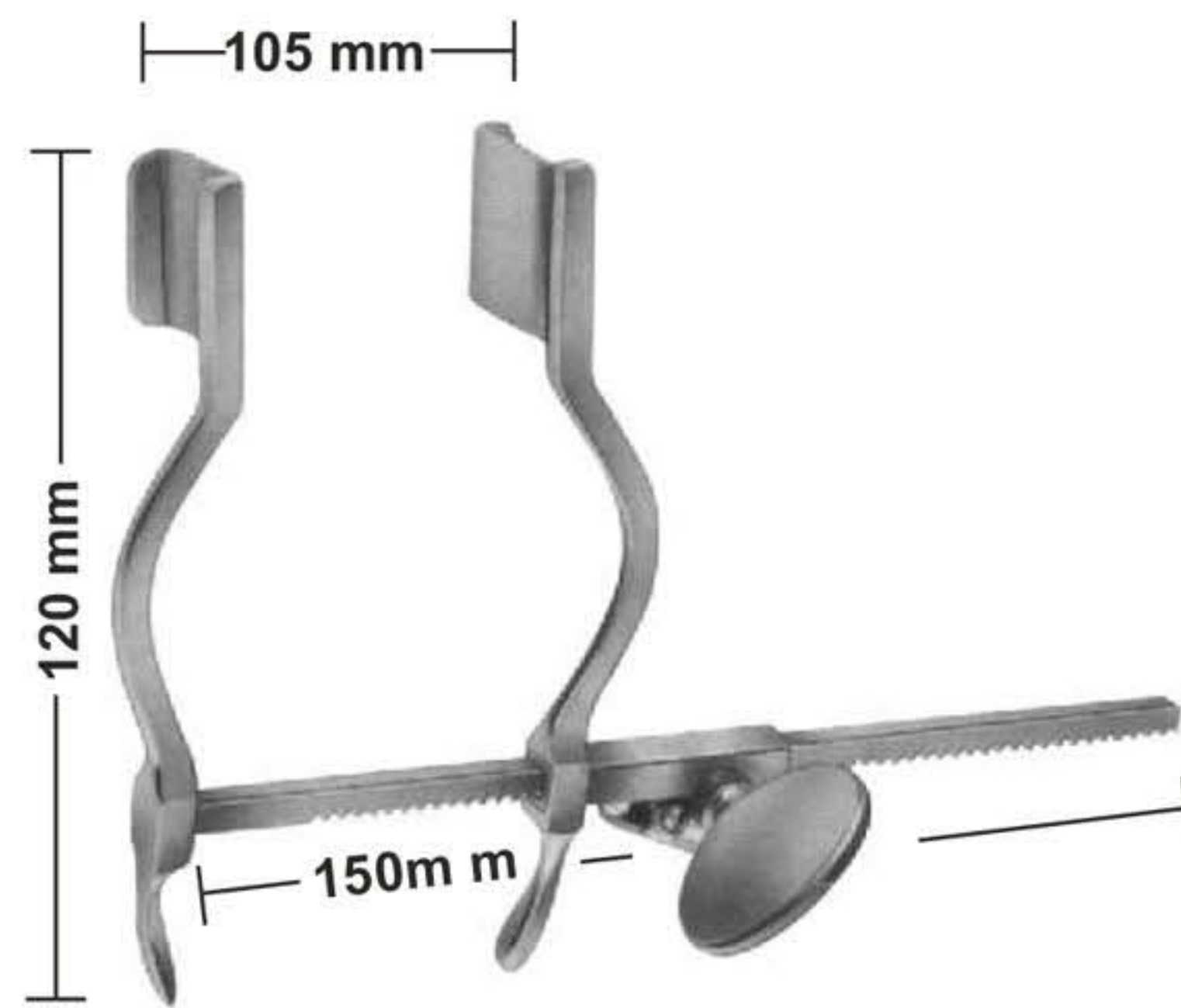

**08-533**  
HERTZLER  
Blades 20 X 25 mm

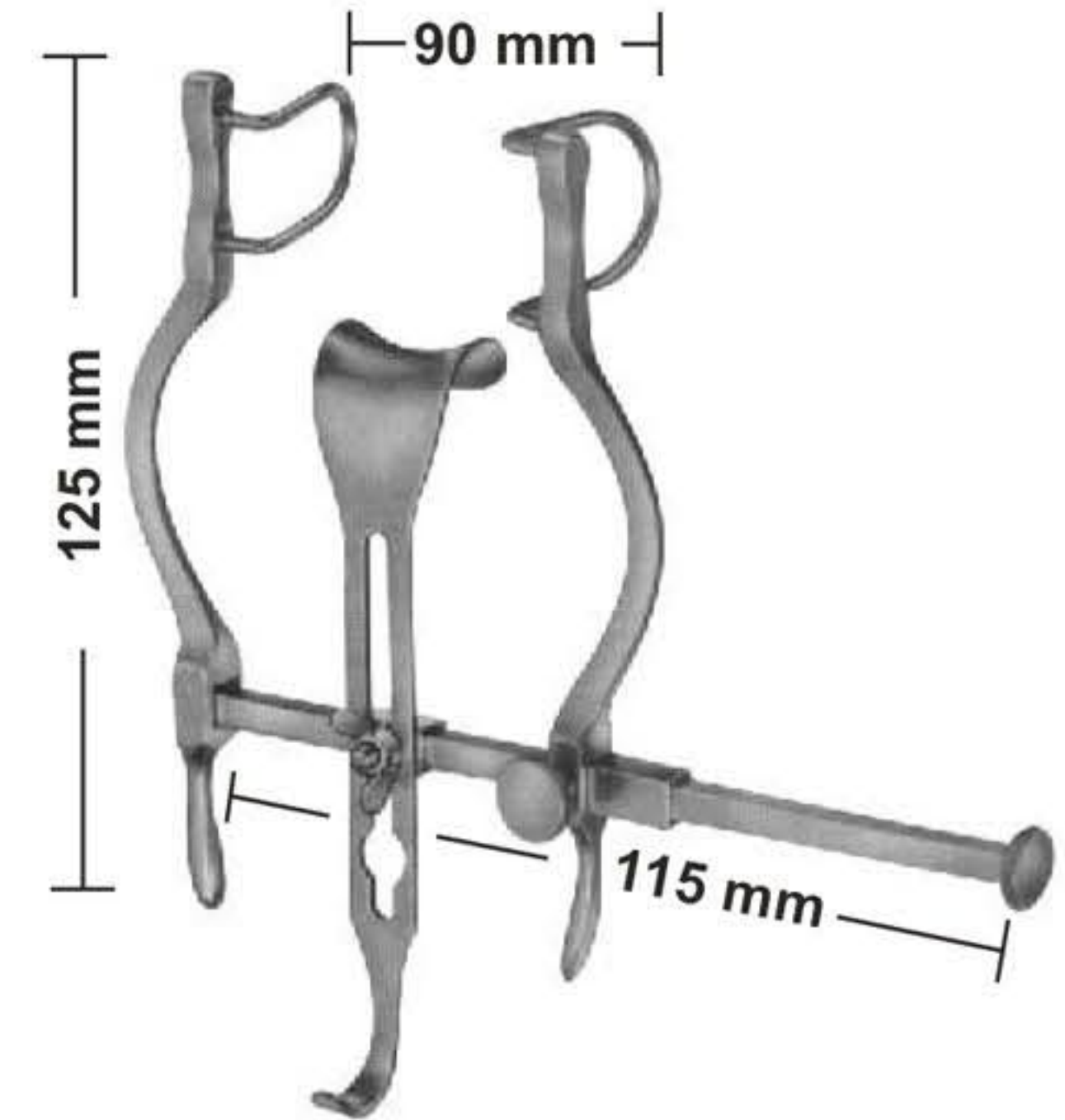

**08-534**  
BALFOUR-BABY  
Lateral blades 27 mm deep  
Center blade 21x24 mm

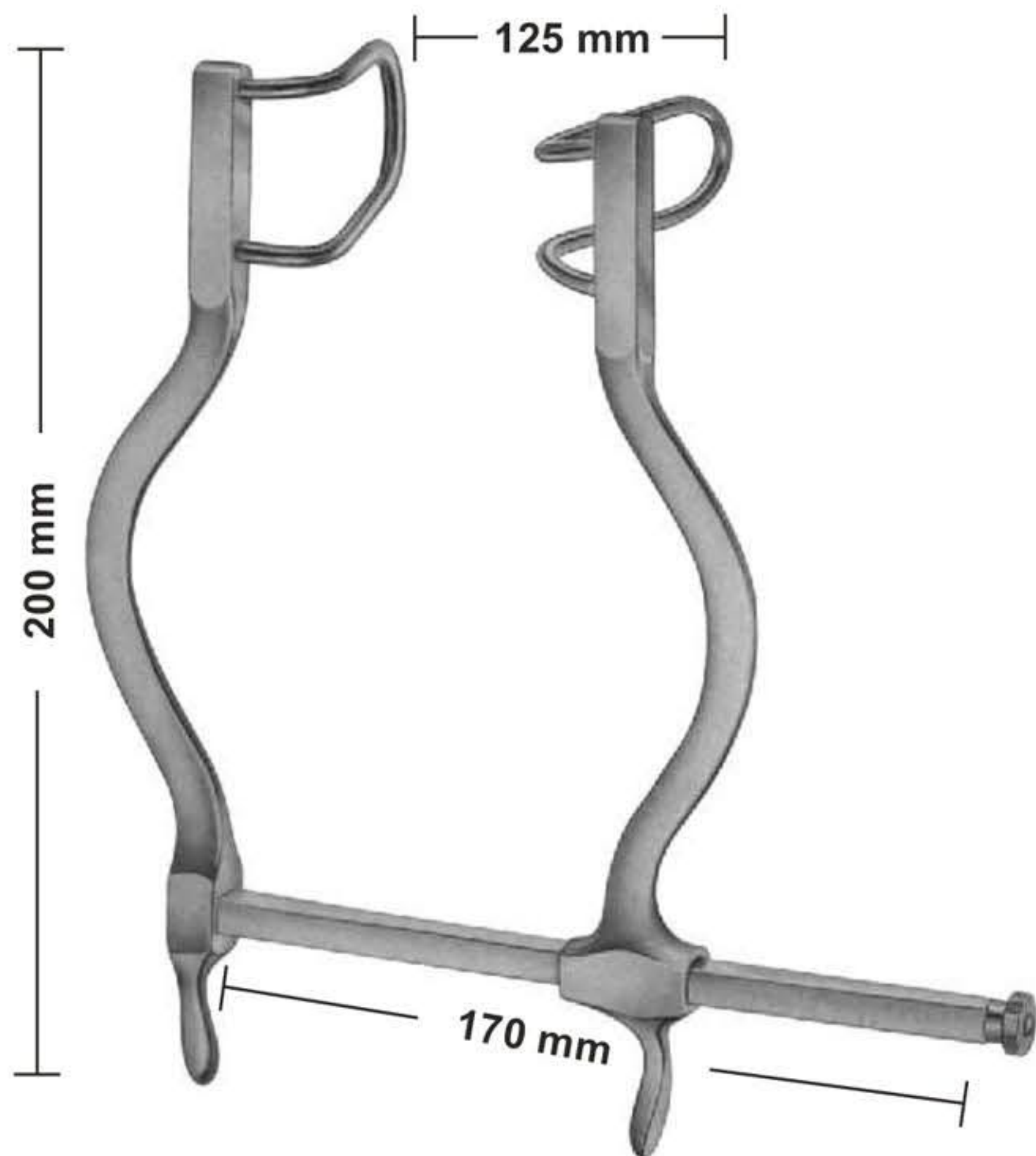

**08-535**  
GOSSET  
Blades:55mm deep

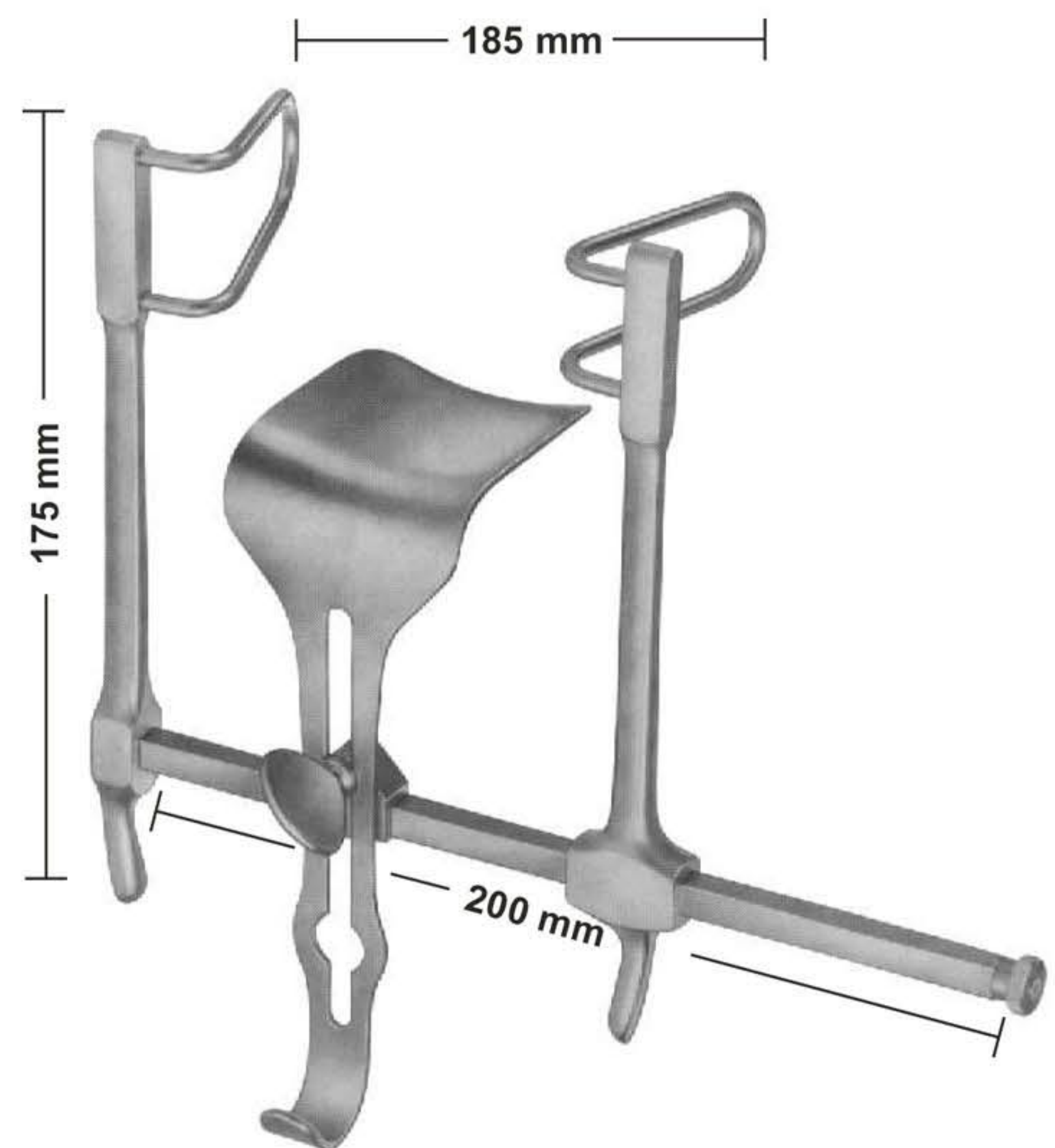

**08-536**  
GOSSET  
Lateral blades 58 mm deep  
Center blade 59 x 57 mm



# Abdominal Retractors

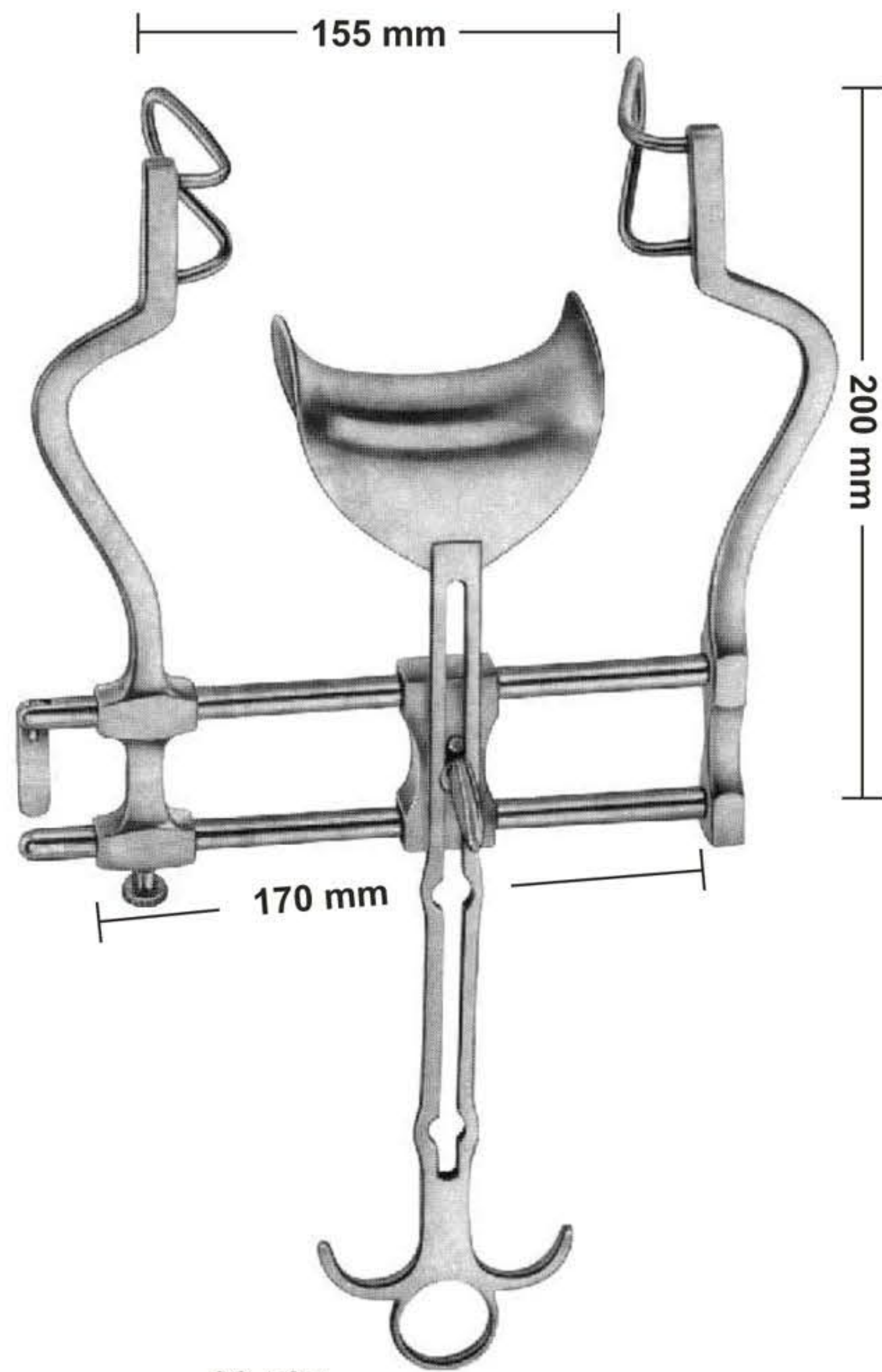

**08-537**  
BALFOUR  
Lateral blades 60 mm deep  
Center blade 47 x 80 mm

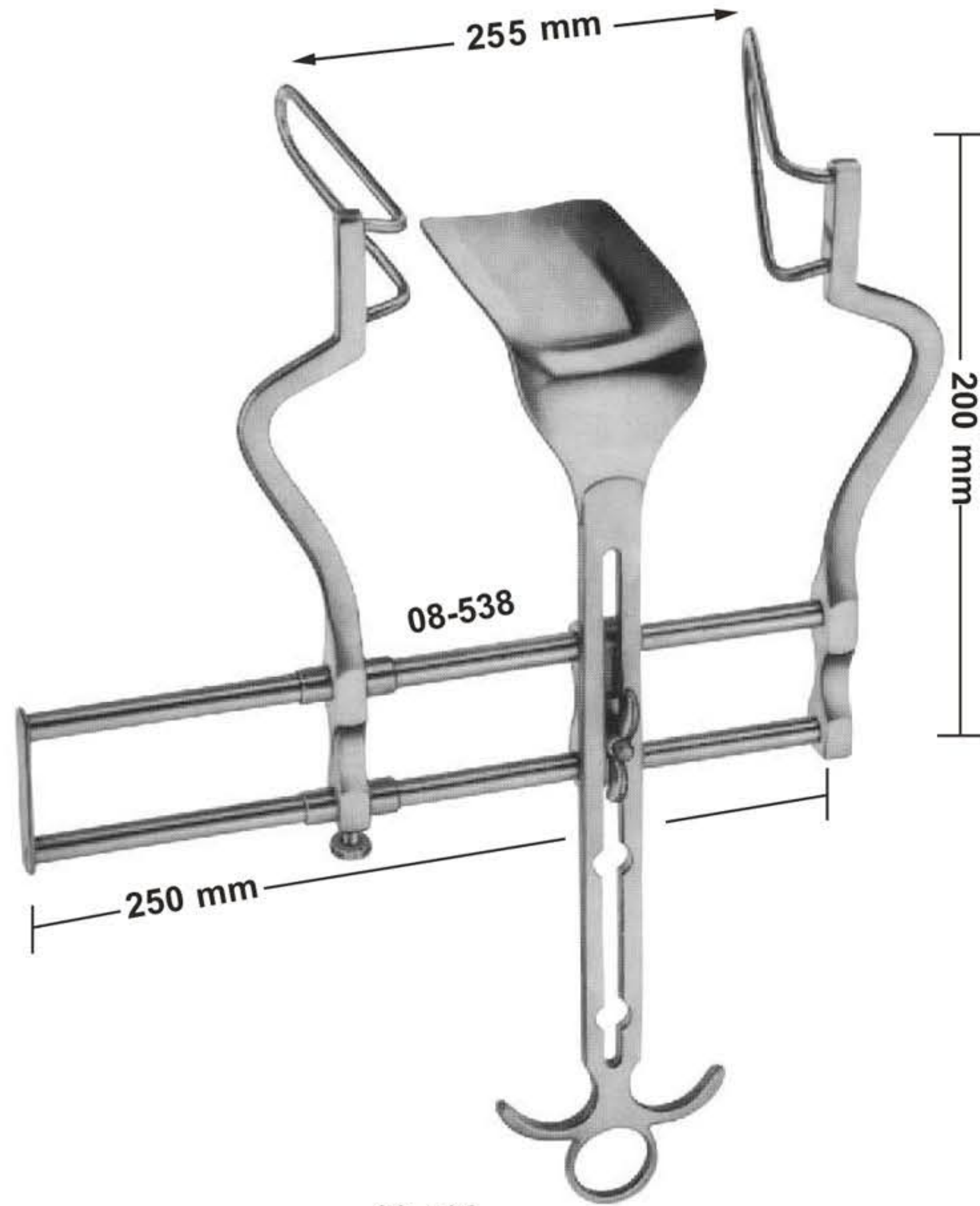

**08-538**  
BALFOUR  
Lateral blades 105 mm deep  
Center blade 107x 59 mm

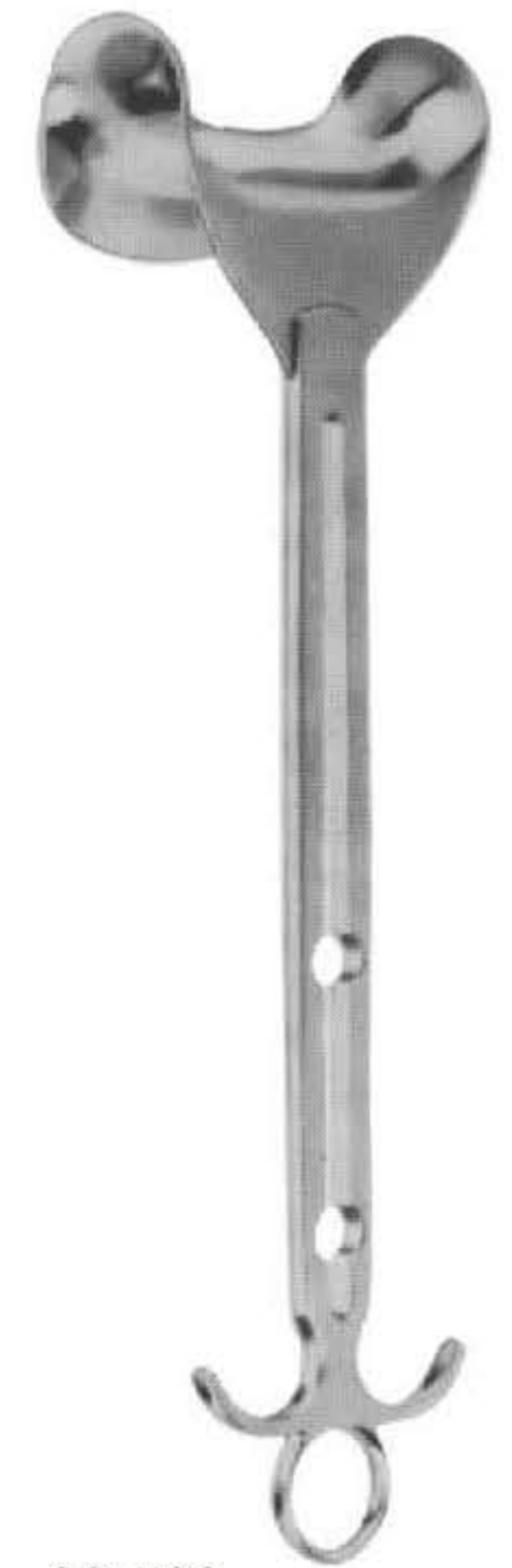

**08-539**  
Center blade only  
54x80 mm

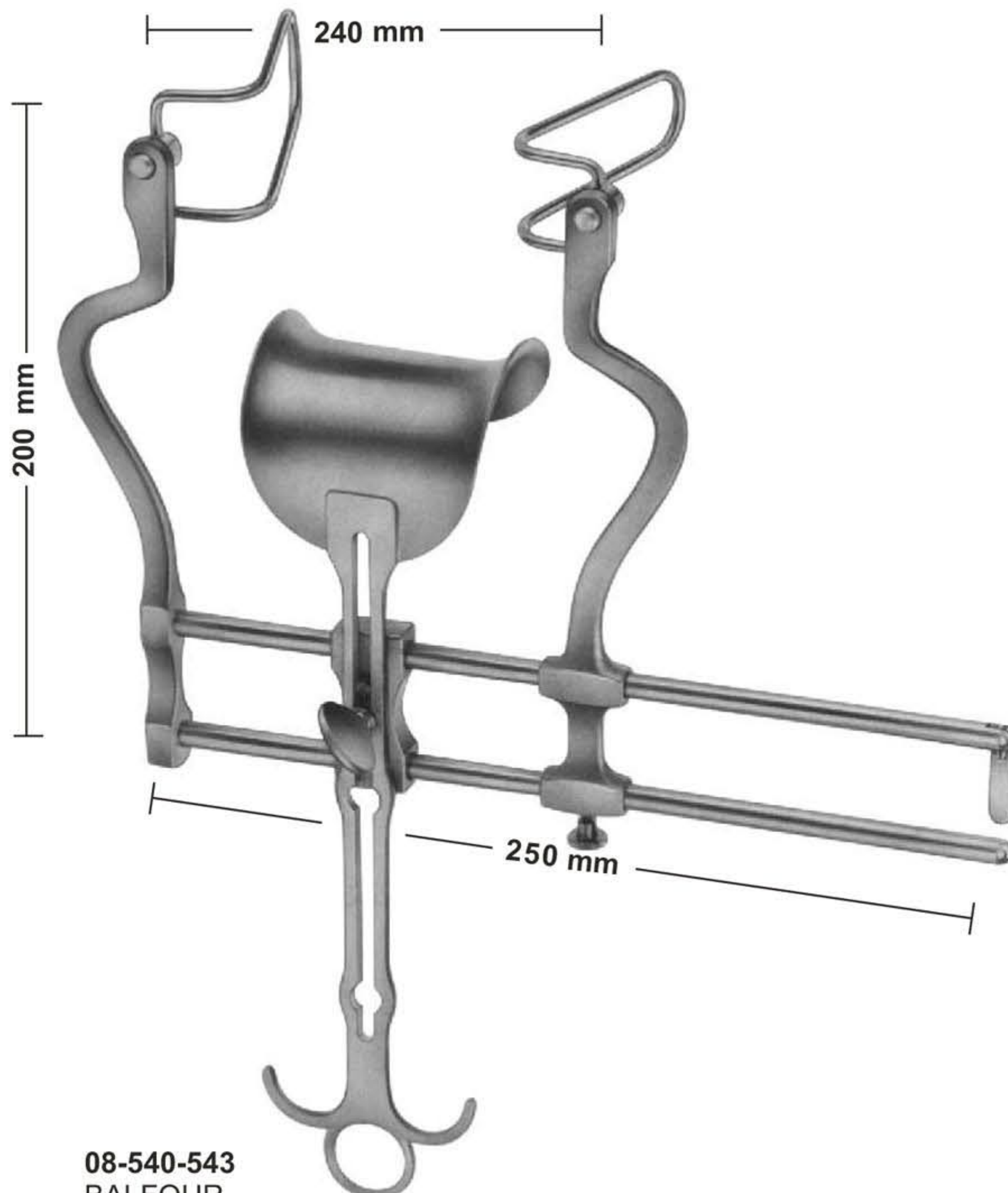

**08-540-543**  
BALFOUR

Spreader only	<b>08-540</b>	<b>08-541</b>	<b>08-542</b>	<b>08-543</b>
Lateral blades	50 mm	60 mm	75 mm	90 mm
Center blade	47 x 80 mm	62x76 mm	80x80 mm	80x80 mm

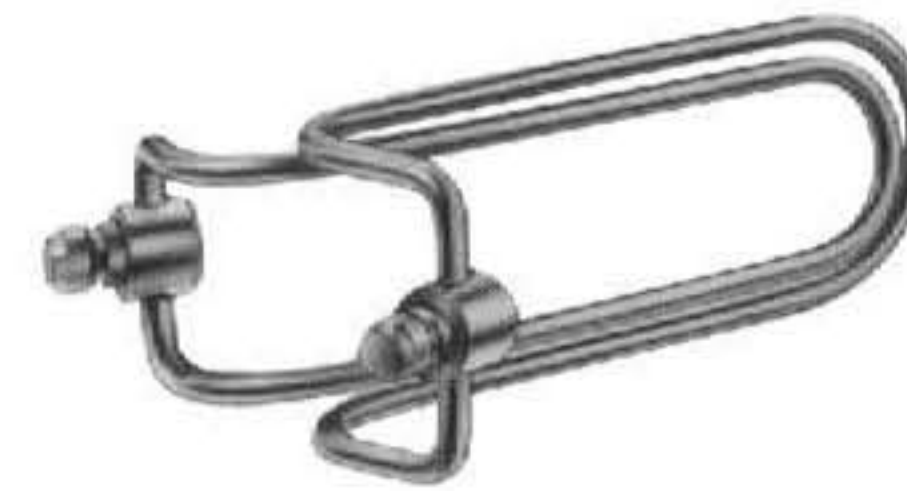

Sales Unit of blades: PR = pair

Lateral blades  
**08-544** 50 mm deep  
**08-545** 60 mm deep  
**08-546** 75 mm deep  
**08-547** 90 mm deep

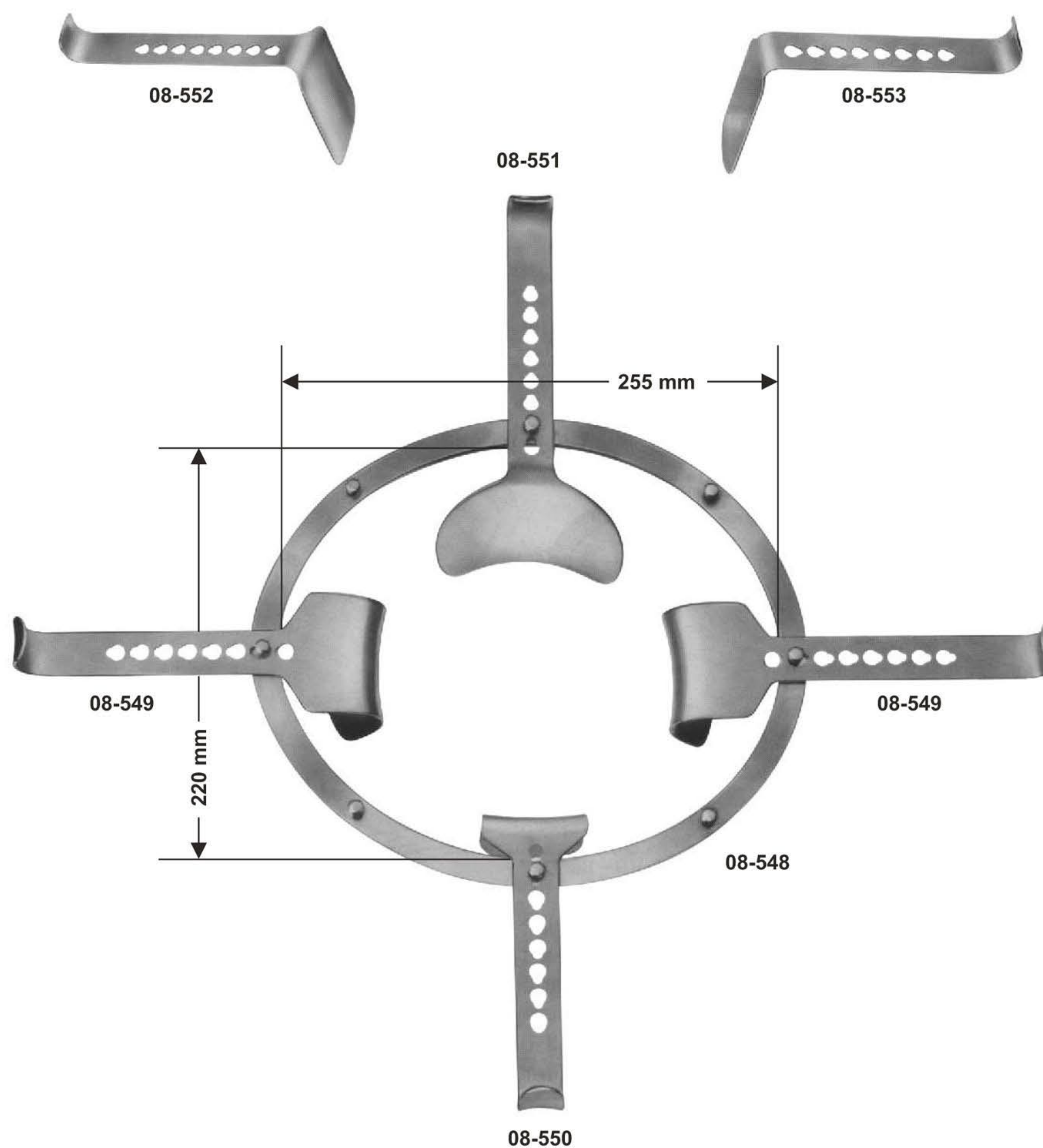

# Abdominal Retractors

**08-548 - 08-553**

SEMM

consisting of:

- 08-548** 1 frame 225 x 220 mm
- 08-549** 2 blades 46 x 64 mm
- 08-550** 1 blade 53 x 54 mm  
(for bladder)
- 08-551** 1 blade 82 x 97 mm  
(for intestine)
- 08-552** 1 blade 98 x 51 mm  
(for intestine)
- 08-553** 1 blade, narrow  
107 x 36 mm



## Abdominal Retractors

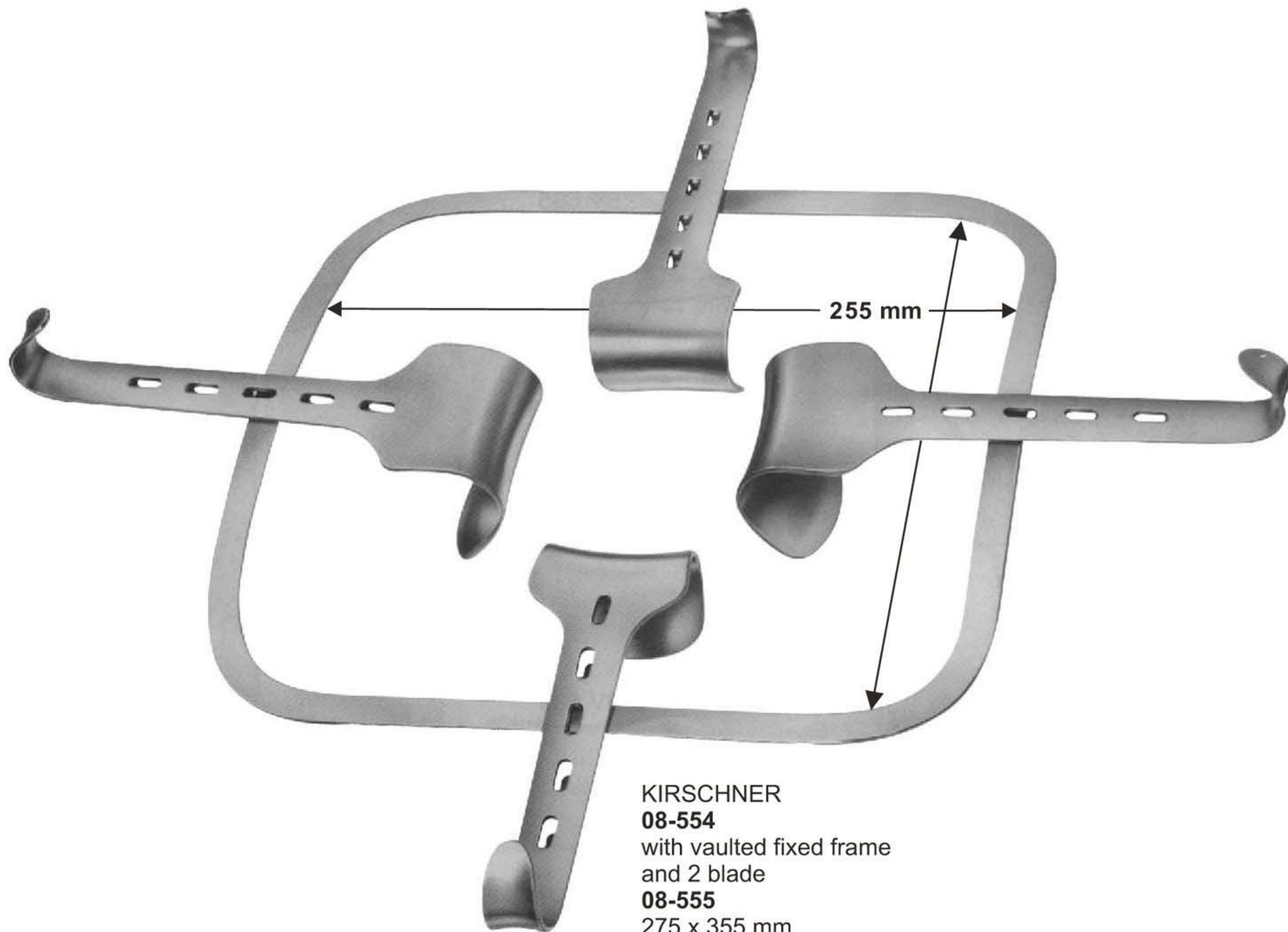

KIRSCHNER  
**08-554**  
 with vaulted fixed frame  
 and 2 blade  
**08-555**  
 275 x 355 mm  
 Frame only, over-sized  
**08-556**  
 295 x 275 mm  
 Frame only



**08-557**  
 KIRSCHNER  
 64 x 80 mm



**08-558**  
 KIRSCHNER-BALFOUR  
 80x 82 mm



**08-559 - 561**  
 KIRSCHNER  
**08-559** 90x 69mm  
**08-560** 92x 95mm  
**08-561** 78x 58mm



**08-562 - 564**  
 KIRSCHNER  
**08-562** 108x42mm  
**08-563** 91x 55mm  
**08-564** 121x 55mm



## Intestinal and Tissue Grasping Forceps

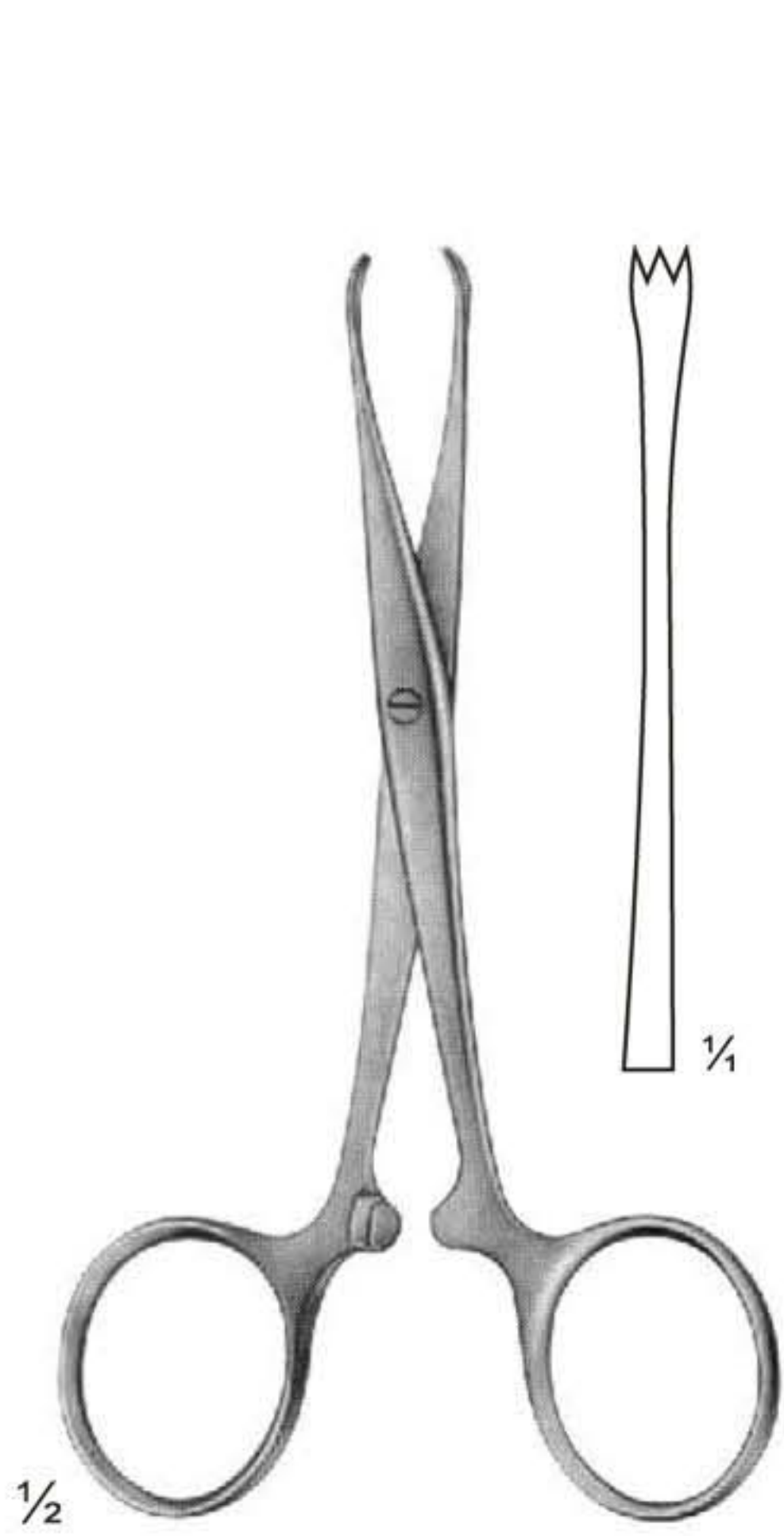

**09-101**  
CHAPUT  
2 X 3 teeth, sharp  
125 mm,

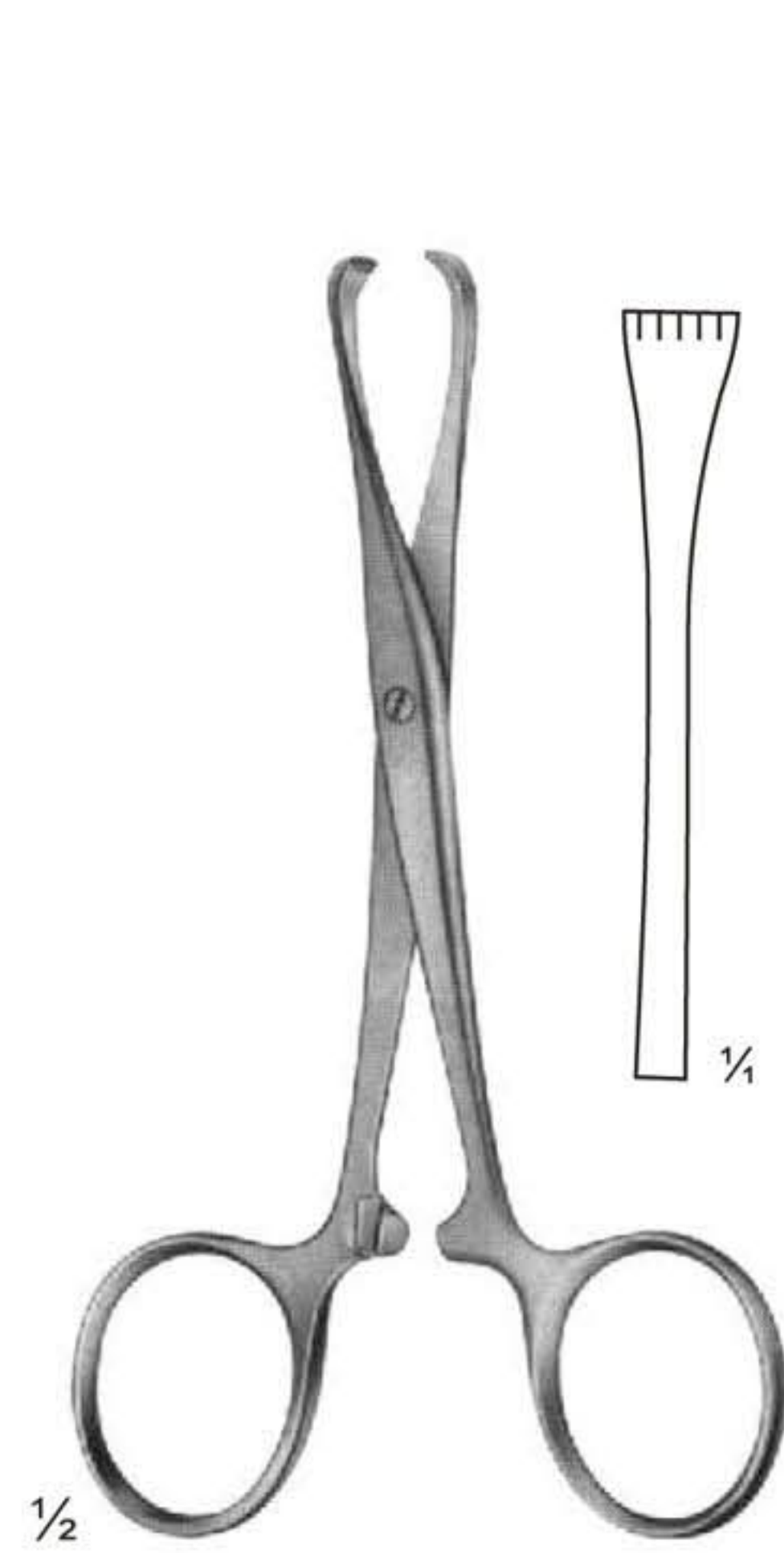

**09-102**  
TUFFIER  
5 X 6 teeth, sharp  
125 mm,



**09-103**  
BOYS-ALLIS  
5 X 6 teeth, sharp  
155 mm,

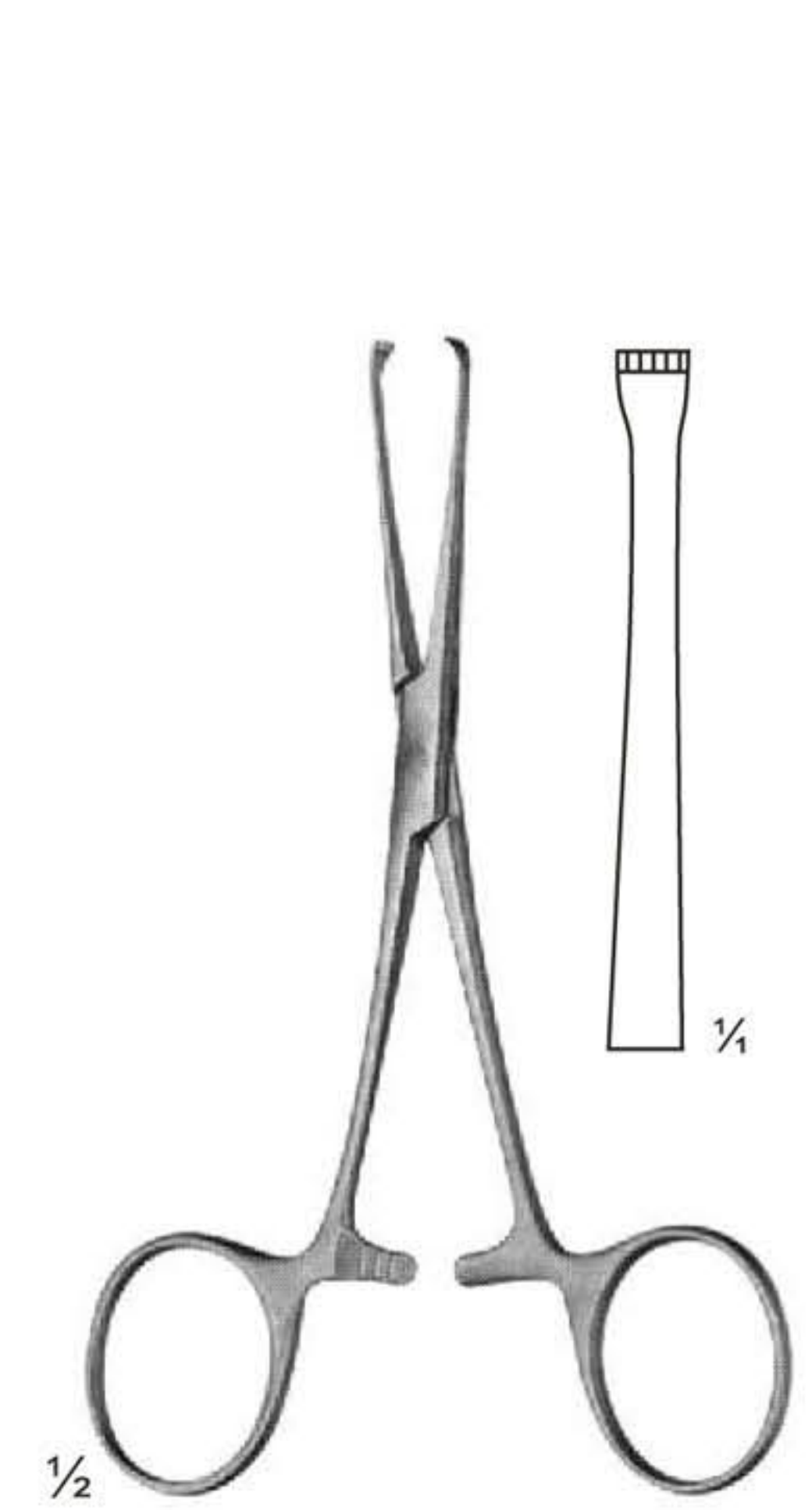

**09-104**  
ALLIS  
4 X 5 teeth  
155 mm,

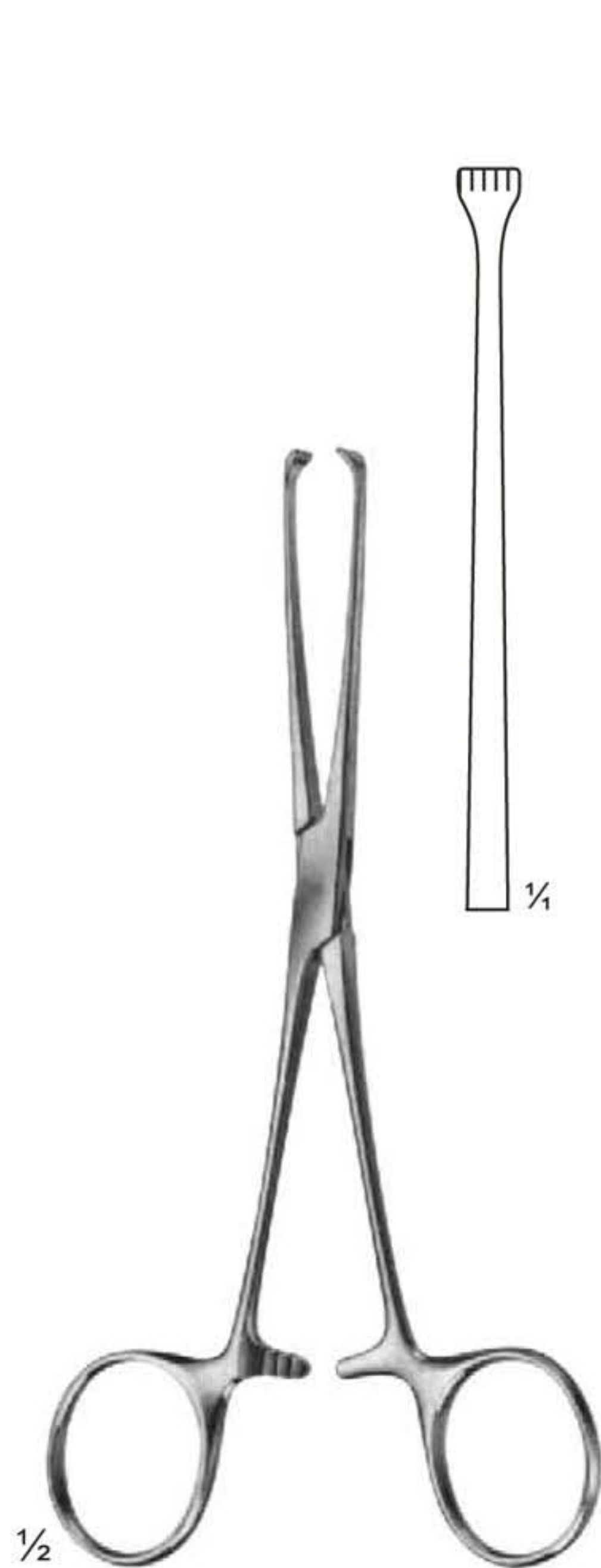

**09-105**  
ALLIS  
155 mm,  
4 X 5 teeth

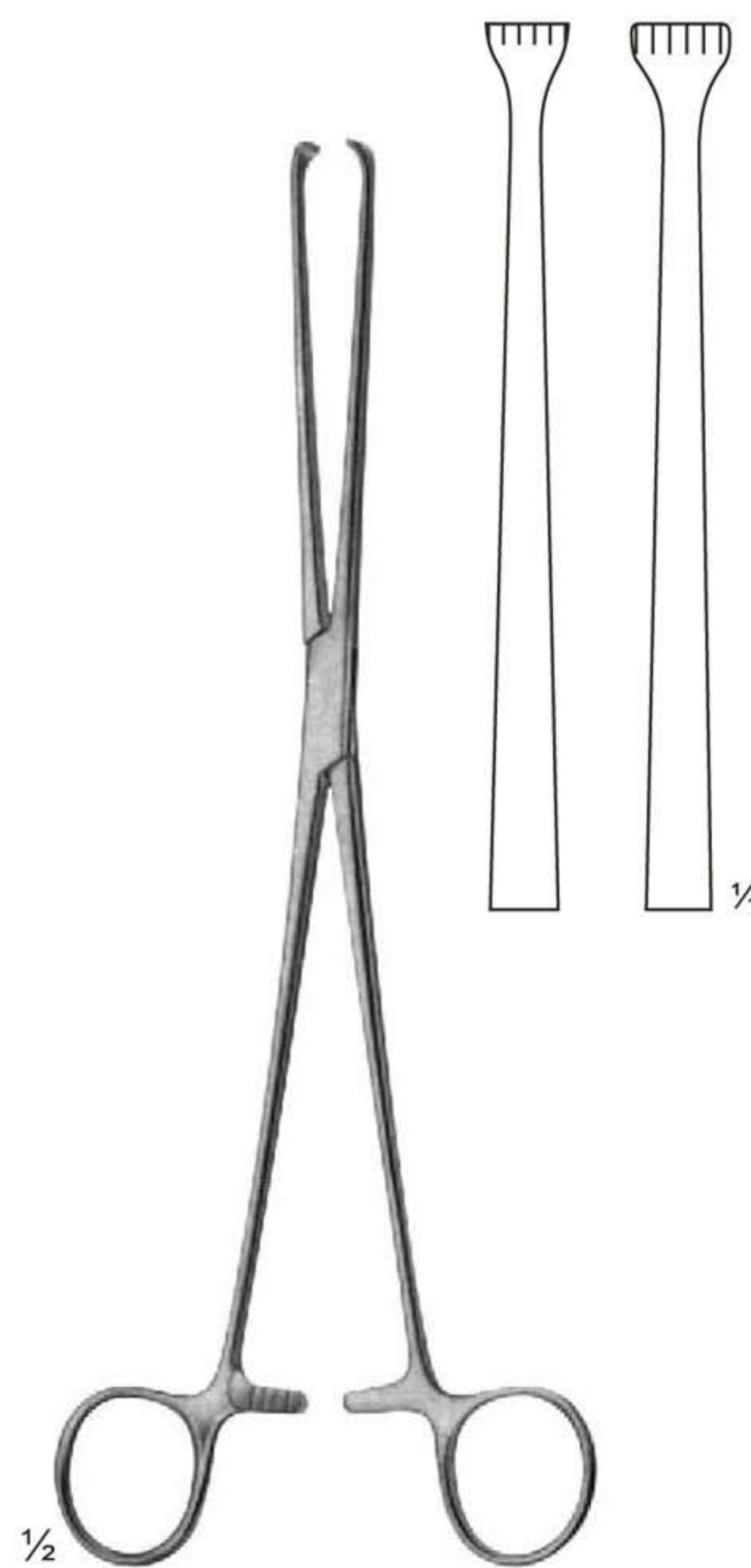

**09-106**  
ALLIS  
190 mm,  
**09-107**  
255 mm,  
5 X 6 teeth

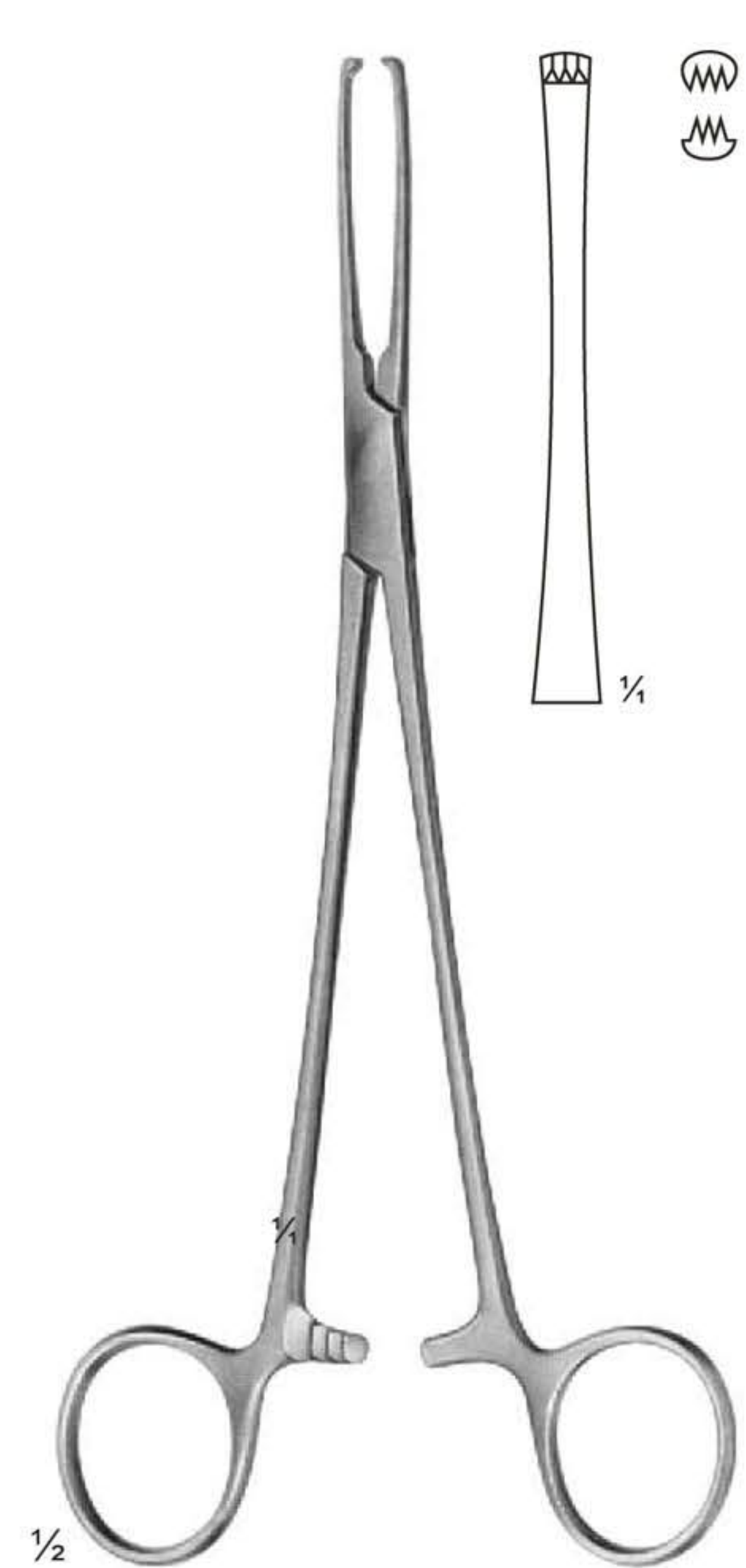

**09-108**  
JUDD-ALLIS  
3 X 4 teeth  
195 mm,



# Intestinal Grasping Forceps

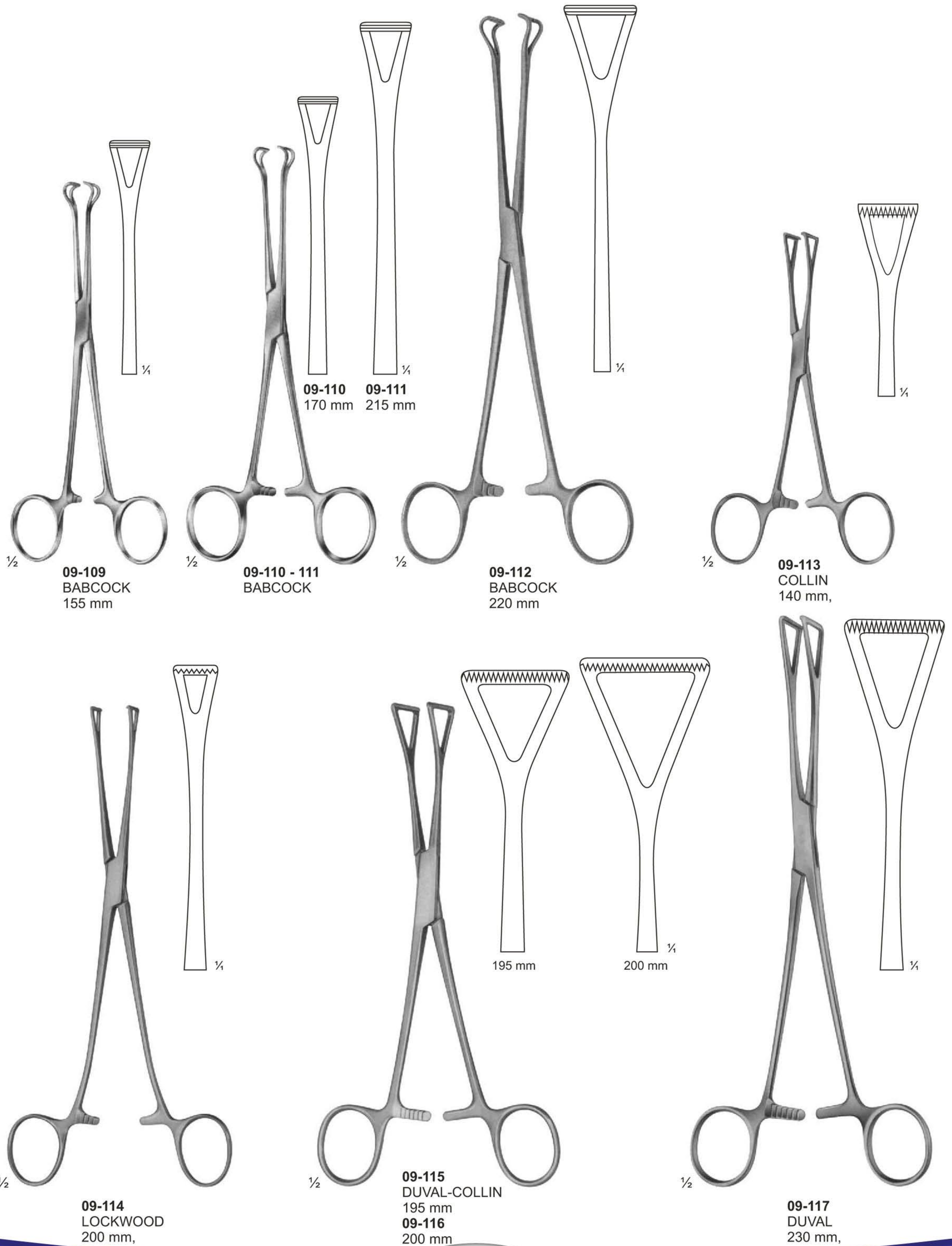



## Organ - Tissue Grasping, Dissecting & Intestinal Forceps

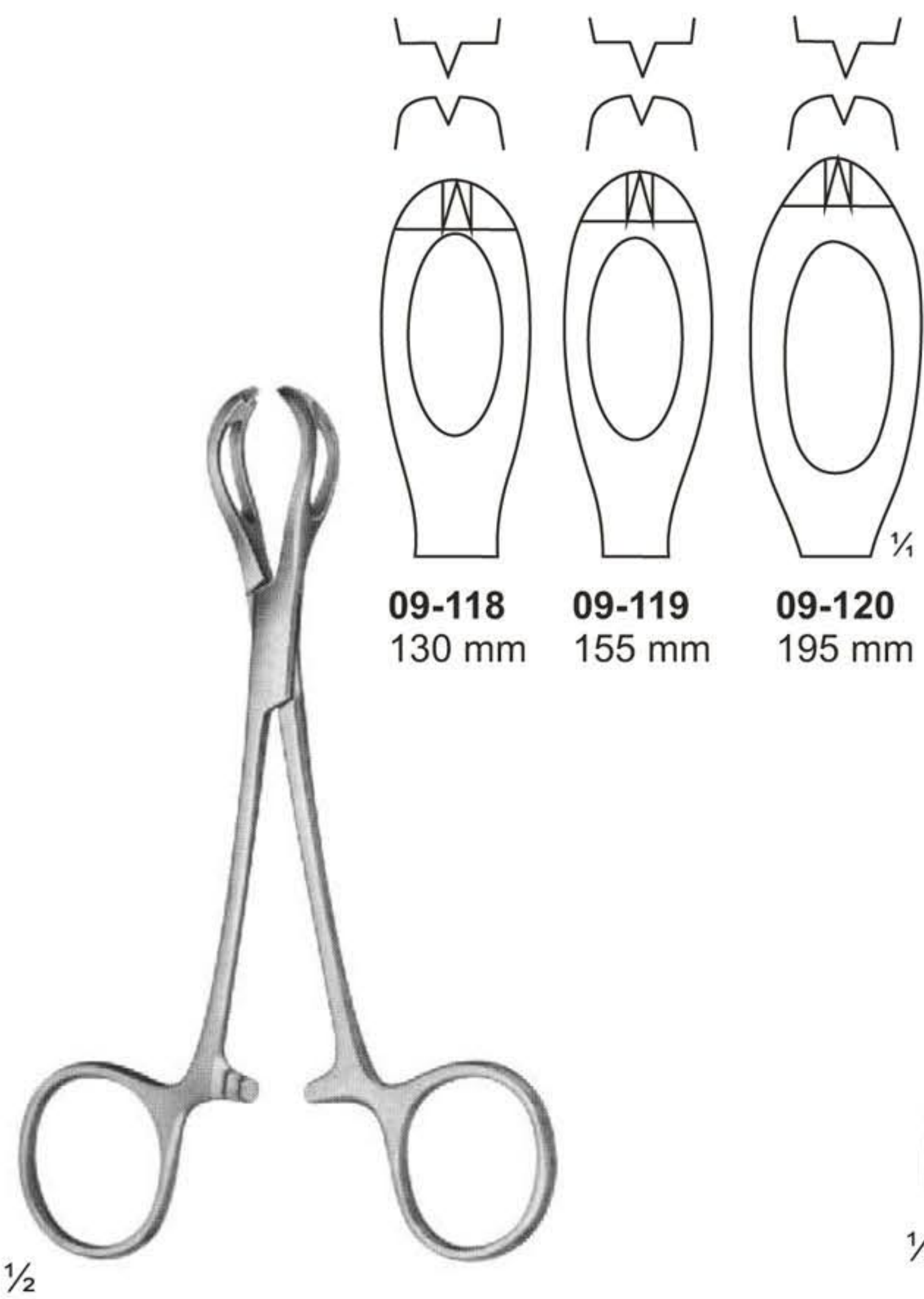

**09-118-120**  
LANE

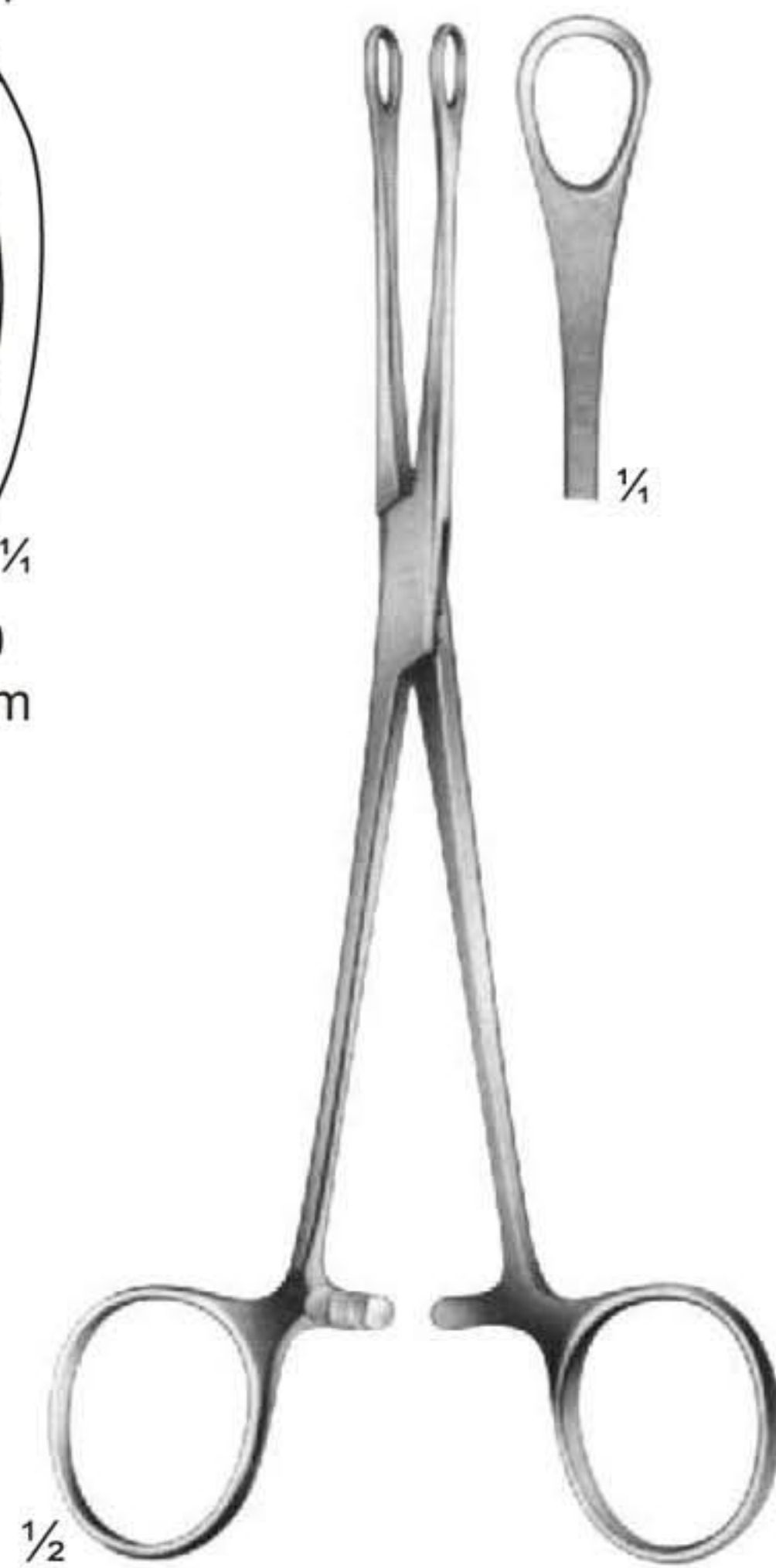

**09-121**  
WILLIAMS  
160 mm



**09-122**  
DENIS  
BROWNE  
190 mm

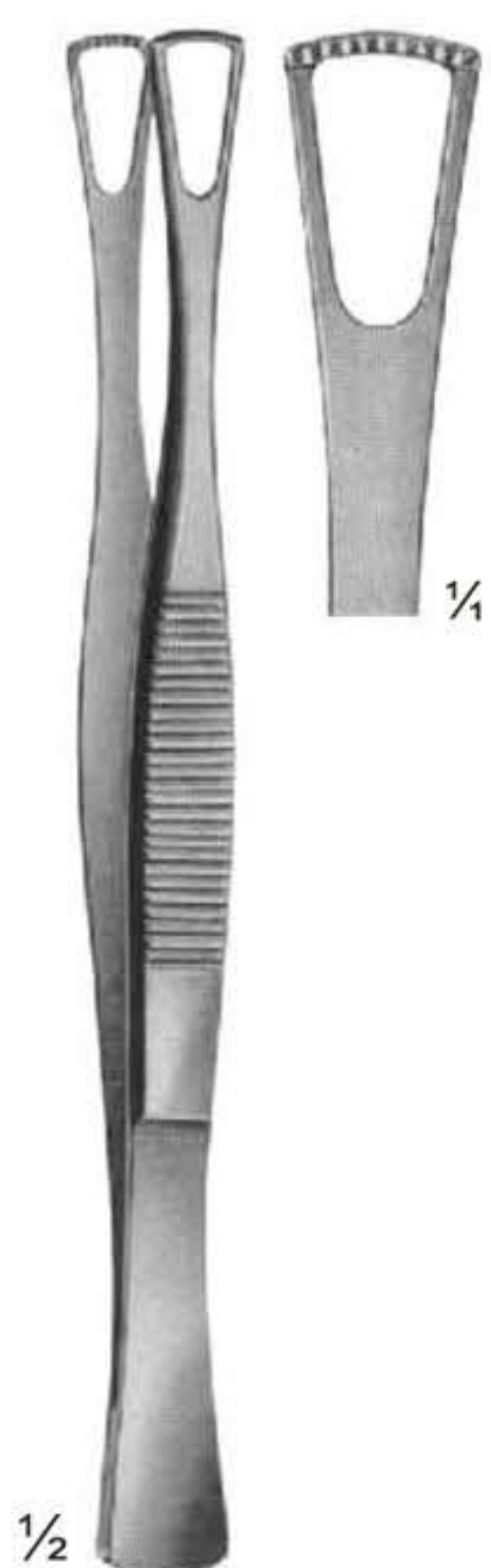

**09-123**  
DUVAL  
140 mm



**09-124**  
WANGENSTEEN  
150 mm  
**09-125**  
230 mm



**09-126**  
WANGENSTEEN  
150 mm  
**09-127**  
230 mm



# Organ - Tissue Grasping, Dissecting & Intestinal Forceps

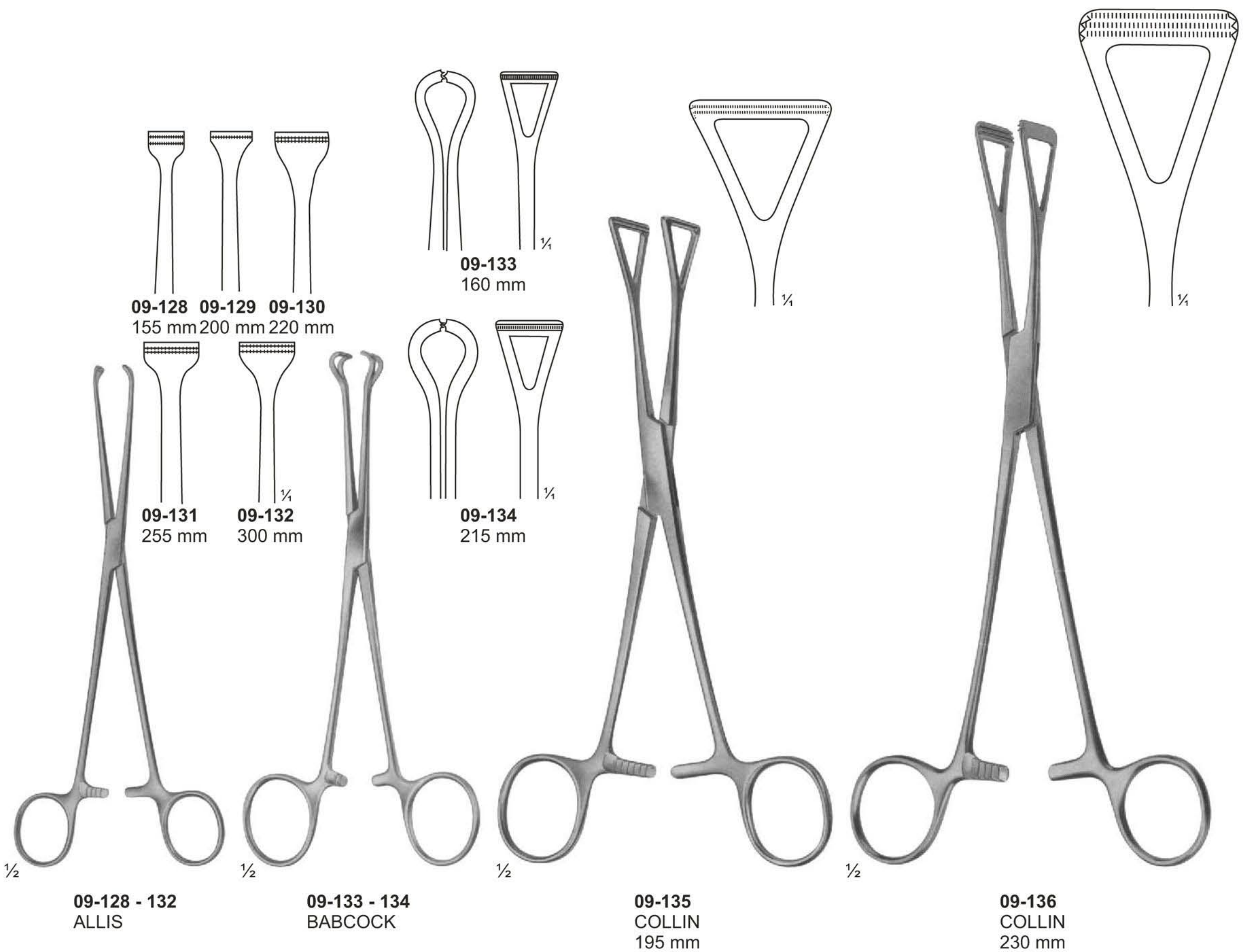



# Ultra - Light - Forceps, Dissecting Forceps

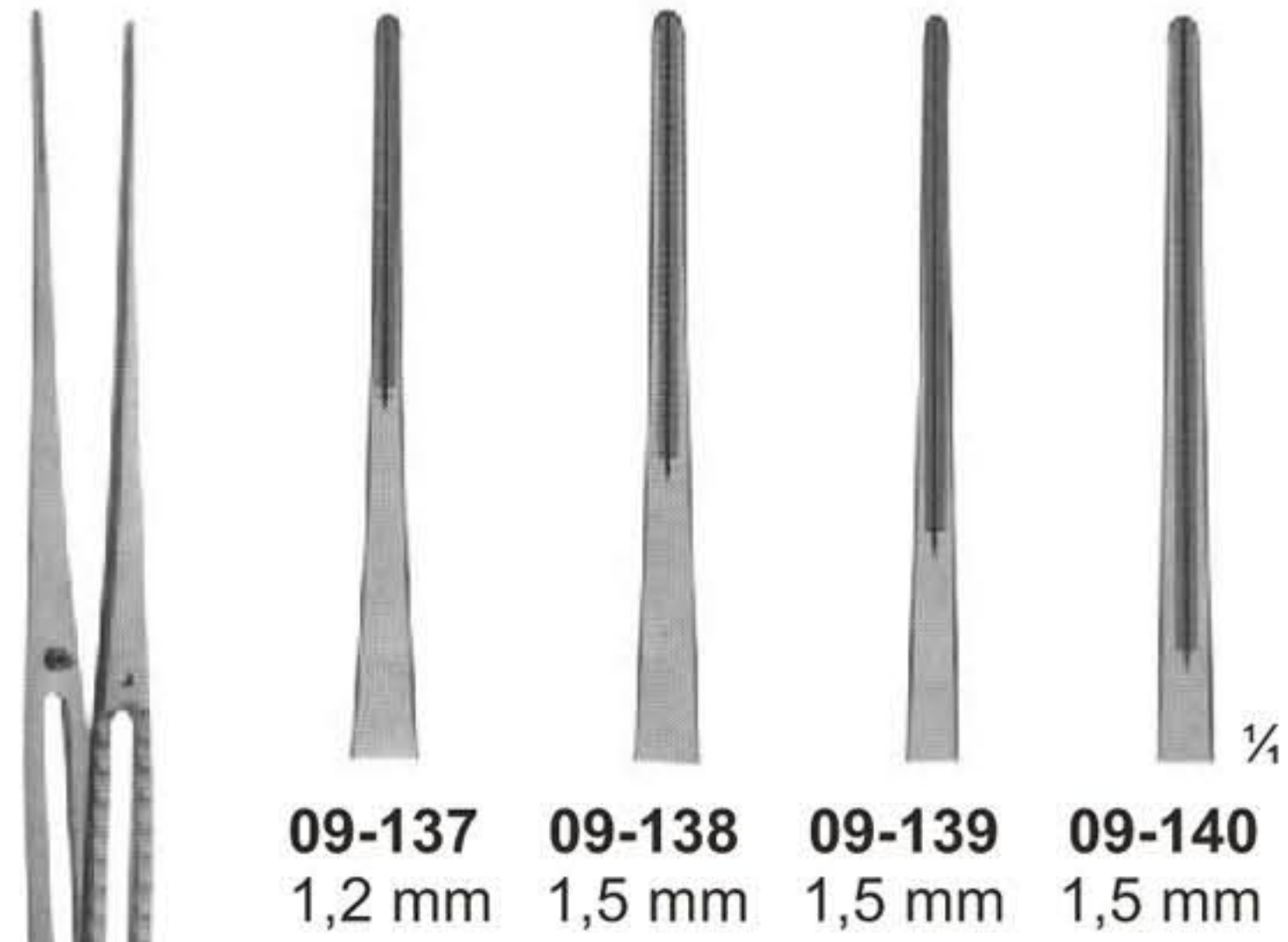

1/2  
**09-137** 150 mm  
**09-138** 200 mm  
**09-139** 240 mm  
**09-140** 300 mm



1/2  
**DE BAKEY**  
**09-141** 150 mm  
**09-142** 200 mm  
**09-143** 240 mm  
**09-144** 300 mm

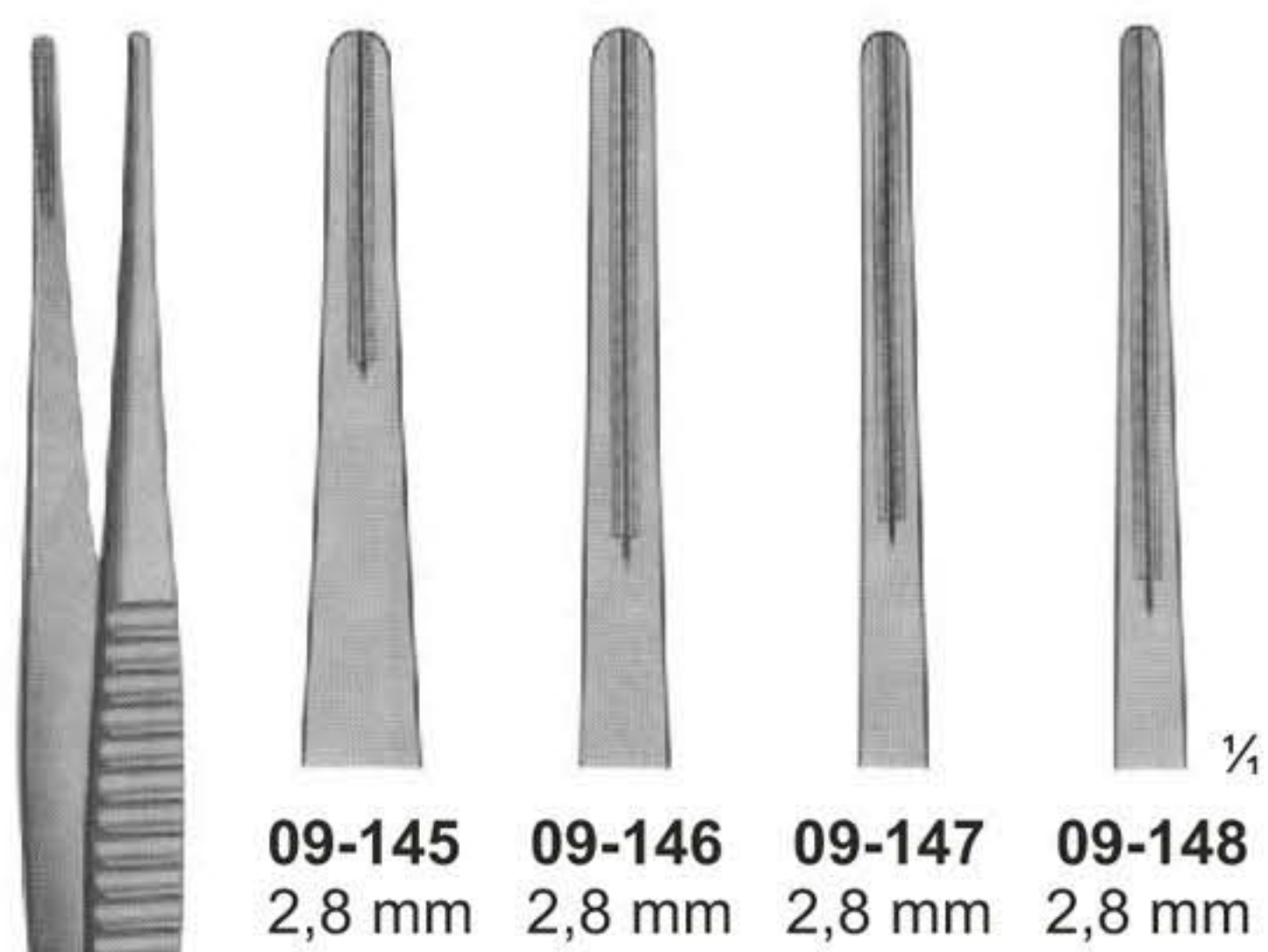

1/2  
**DE BAKEY**  
**09-145** 150 mm  
**09-146** 200 mm  
**09-147** 240 mm  
**09-148** 300 mm

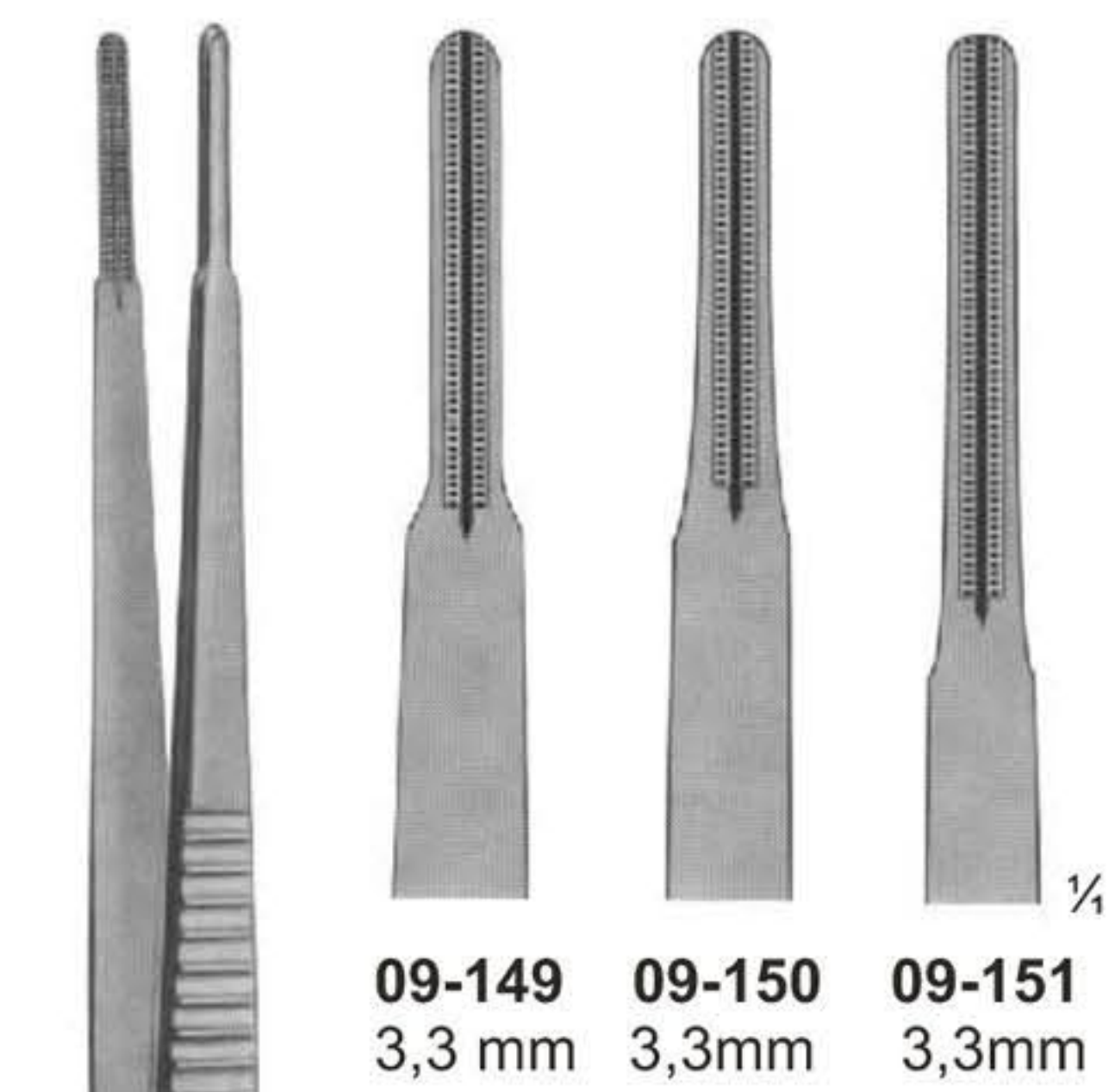

1/2  
**DE BAKEY**  
**09-149** 200 mm  
**09-150** 240 mm  
**09-151** 300 mm



## Intestinal Clamps for Children

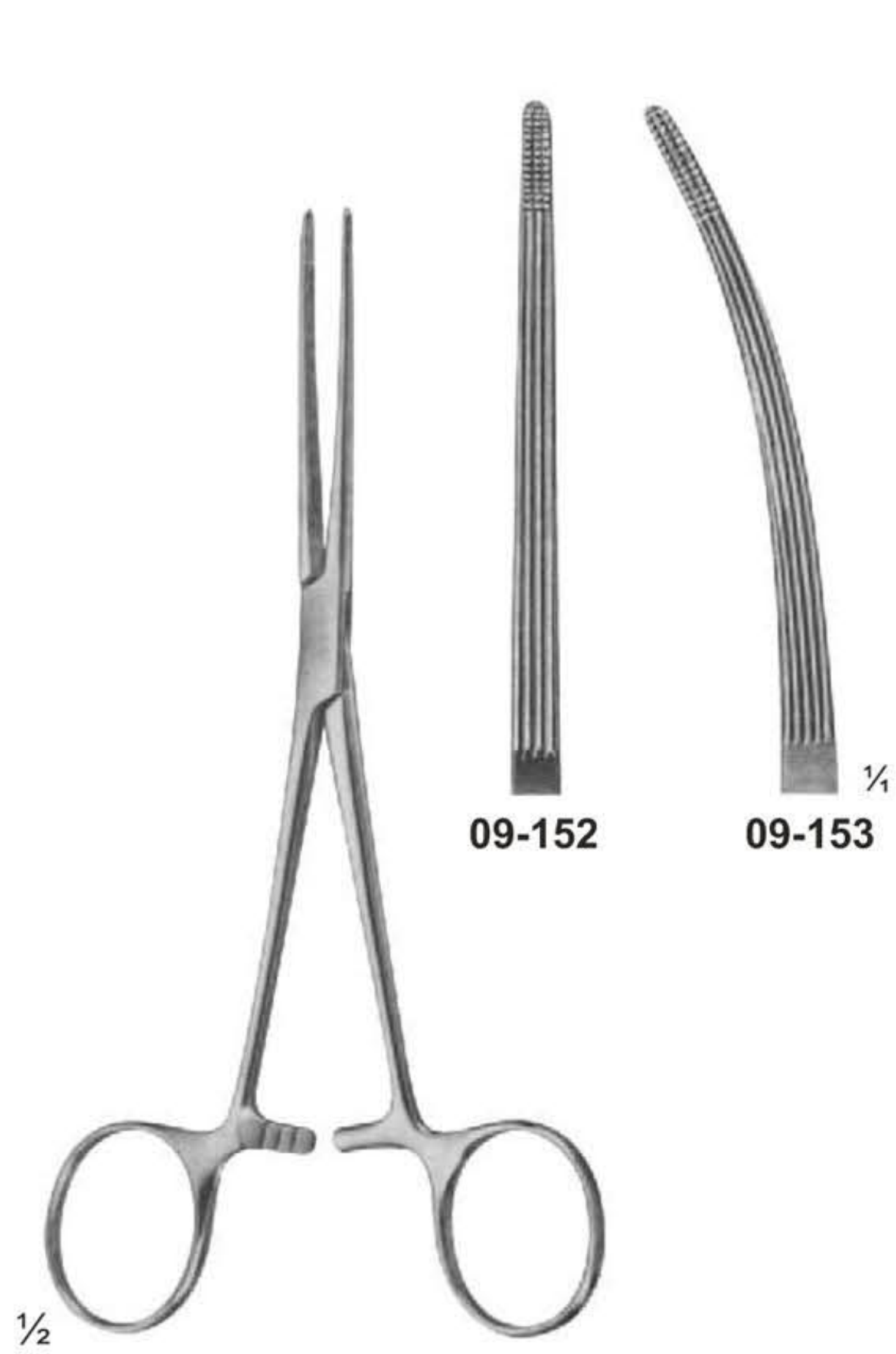

**09-152 - 153**  
BAINBRIDGE  
155 mm

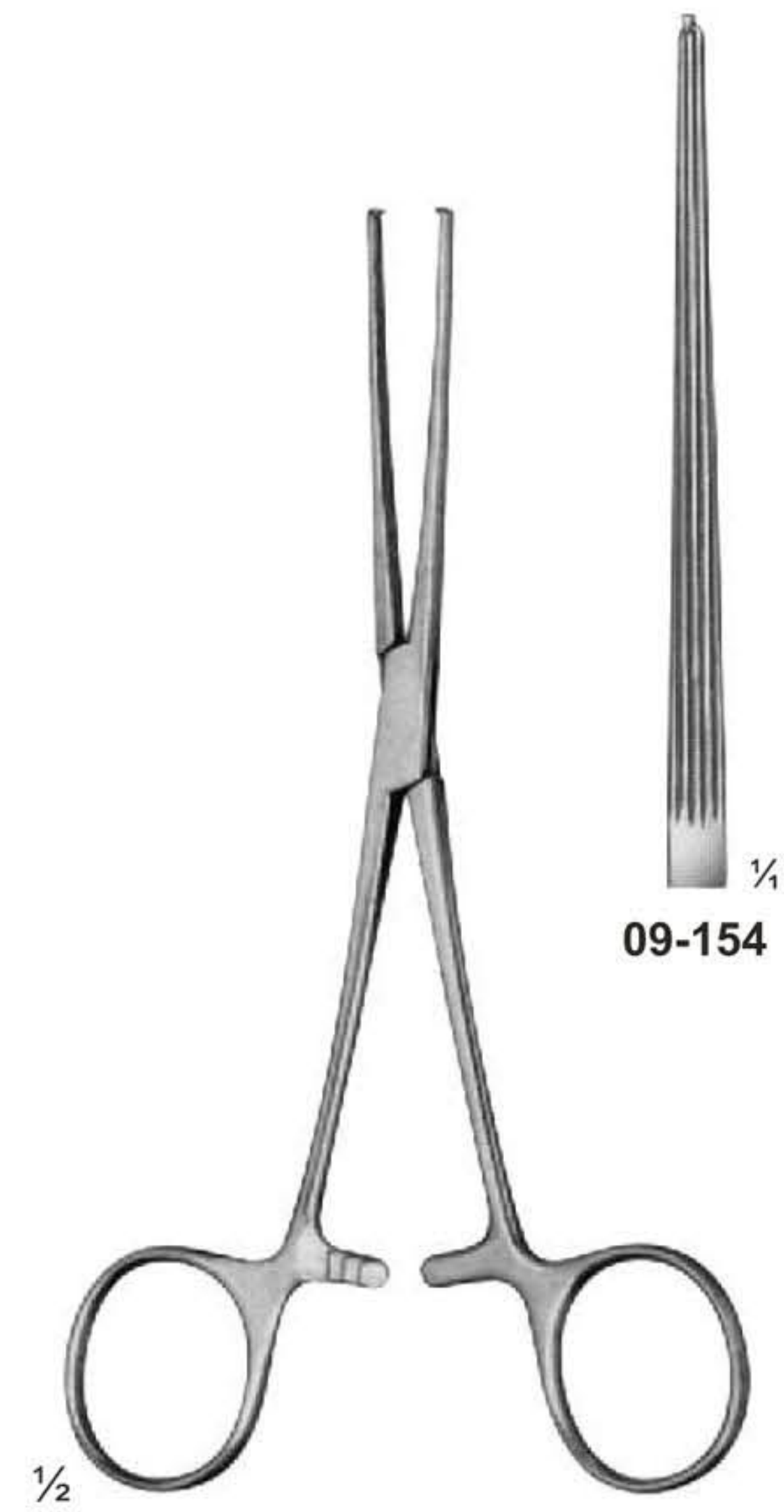

**09-154**  
ALLEN  
155 mm

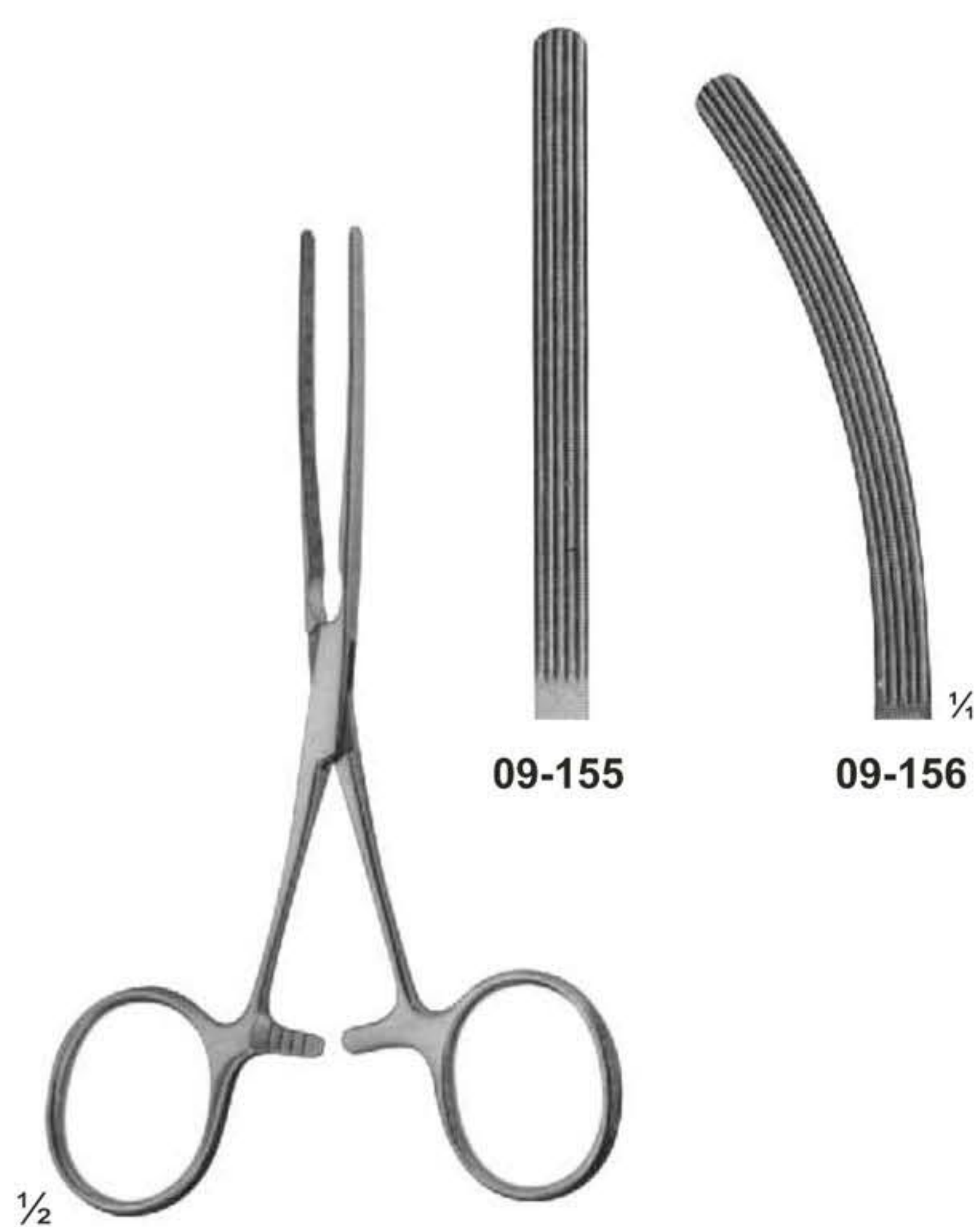

**09-155 - 156**  
BABY-KOCHER  
very elastic blades  
130 mm

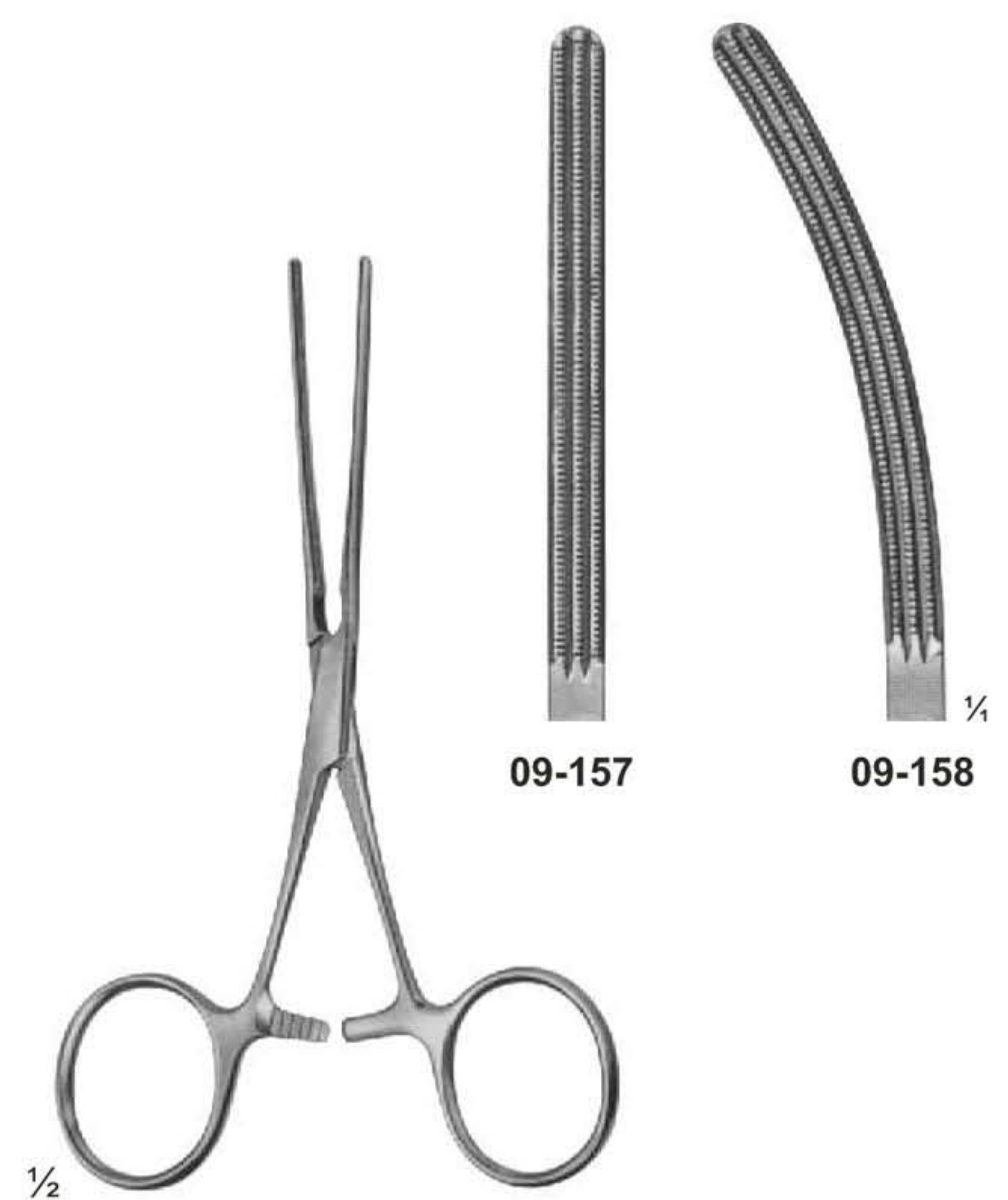

**09-157 - 158**  
BABY-KOCHER  
with elastic blades  
130 mm



**Intestinal Clamps, Soft Elastic**

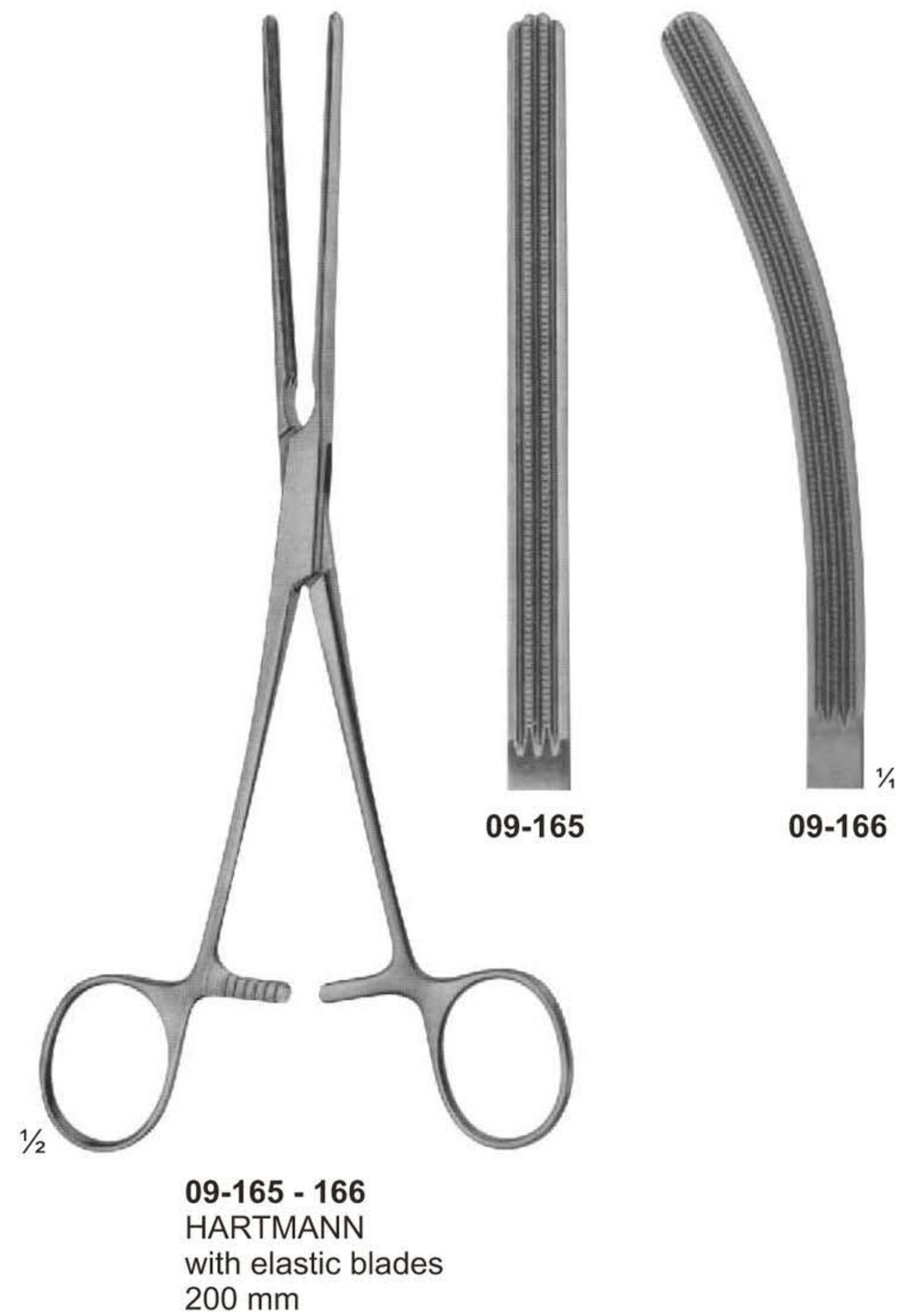
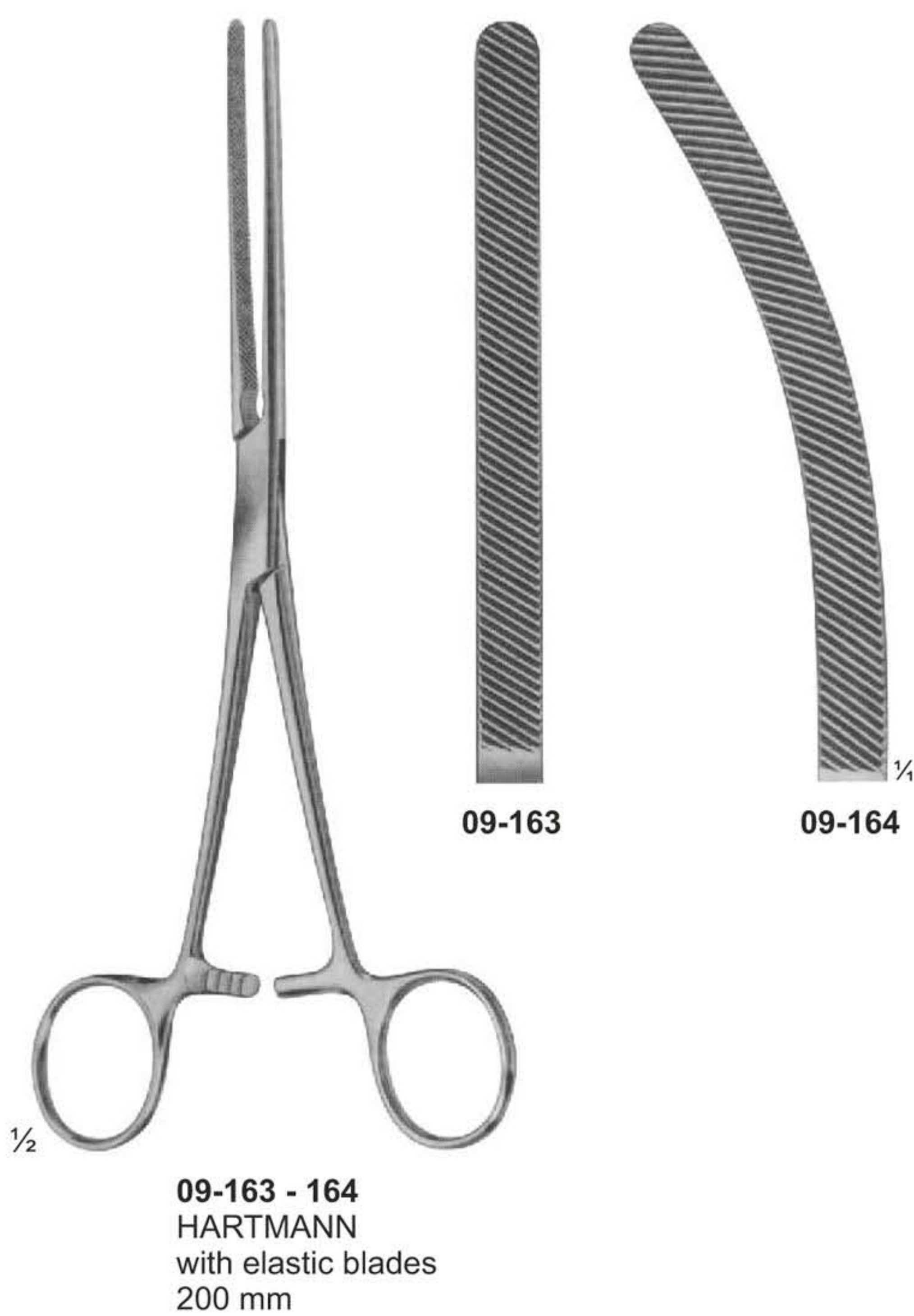
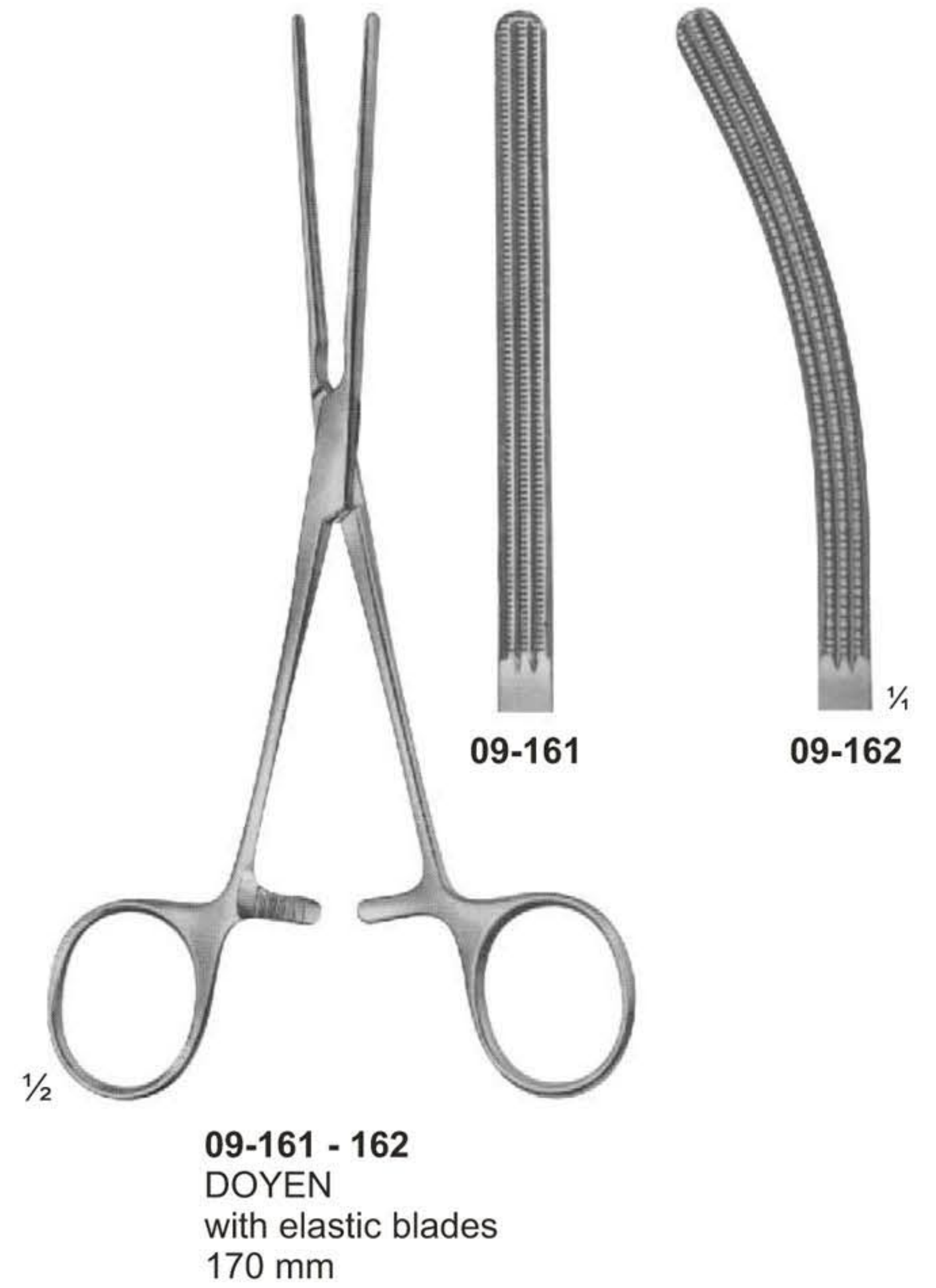
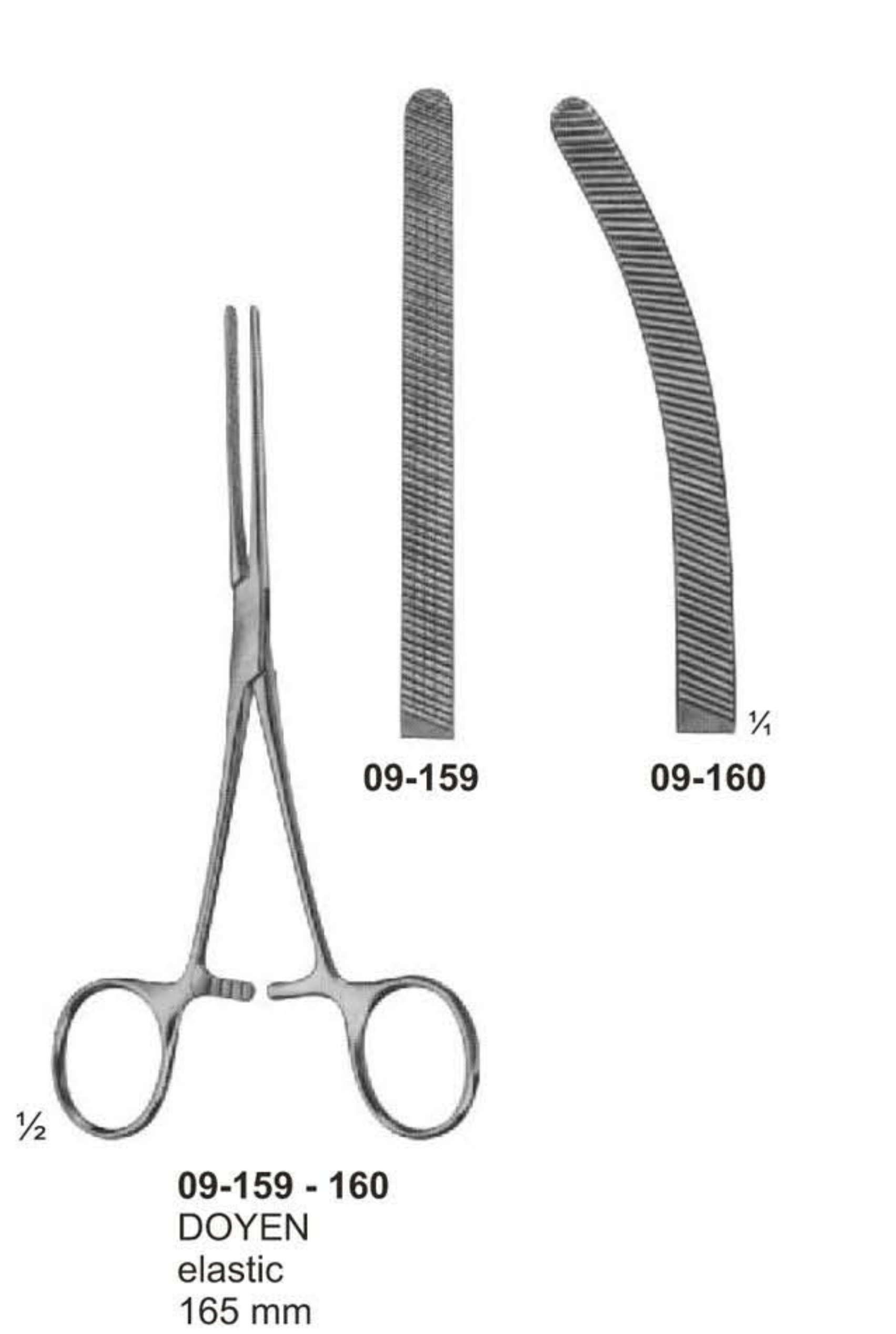



**Intestinal Clamps, Soft elastic**

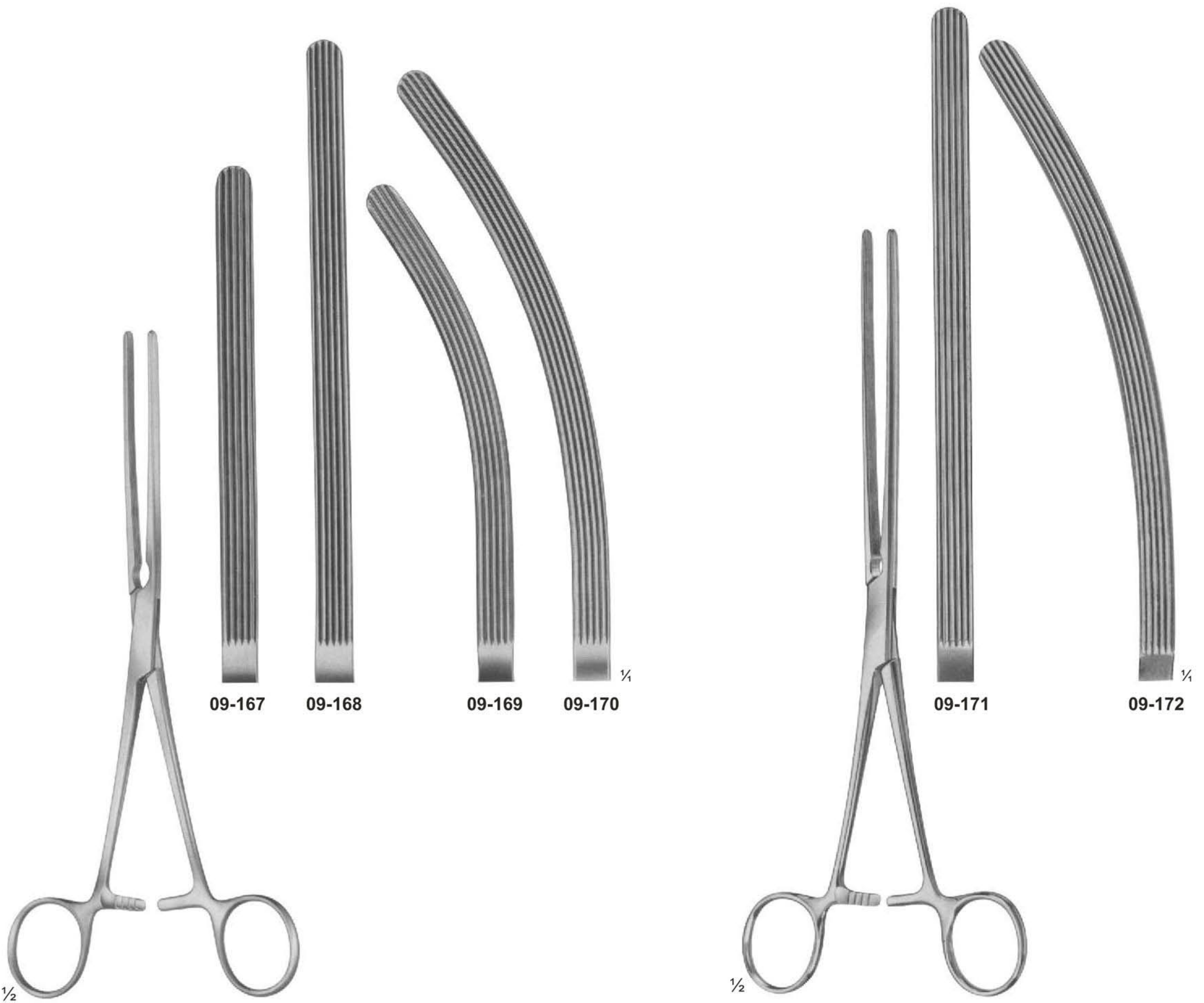

**09-167 - 170**  
KOCHER  
with elastic blades  
**09-169** 210 mm  
**09-170** 230 mm

**09-171 - 172**  
DOYEN  
with elastic blades  
210 mm



**Intestinal Clamps, Soft elastic**



**09-173 - 174**  
DOYEN  
with elastic blades  
235 mm

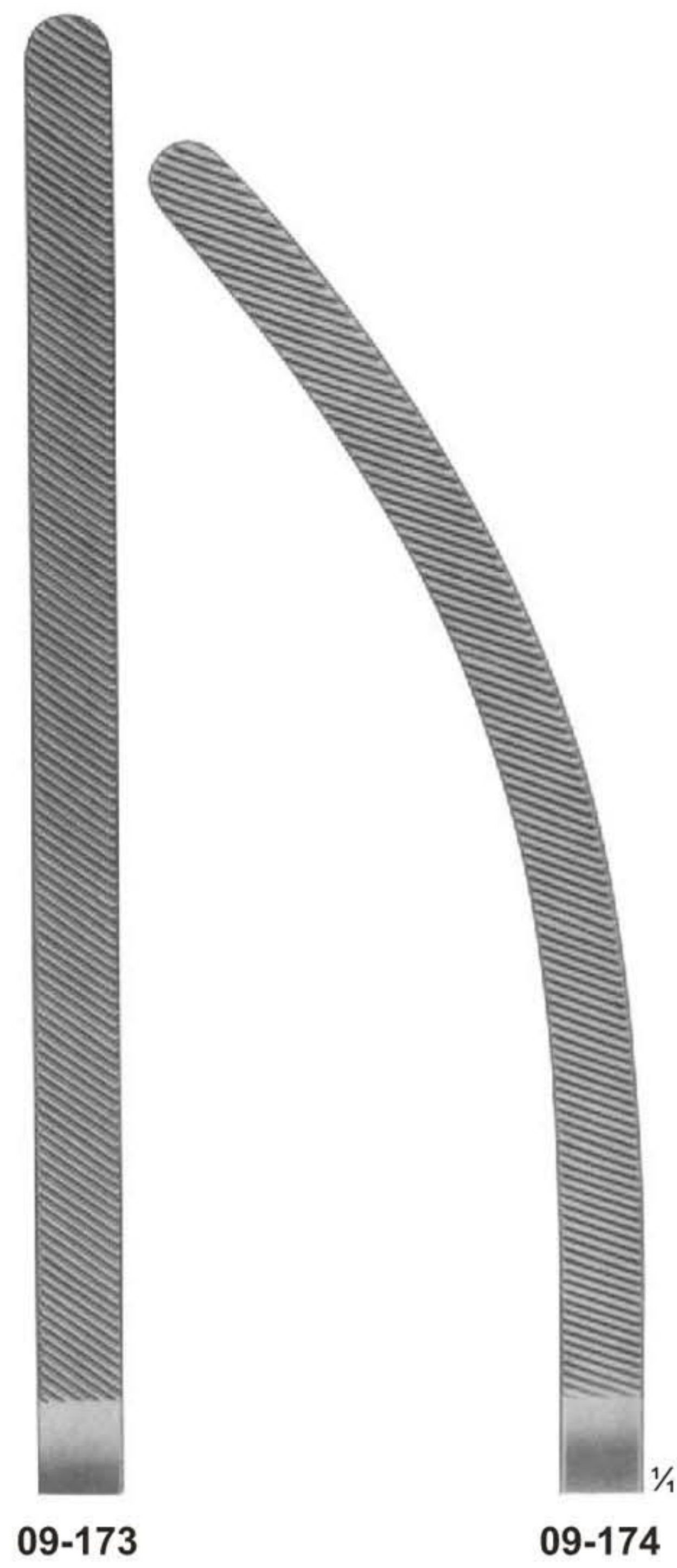

**09-174**

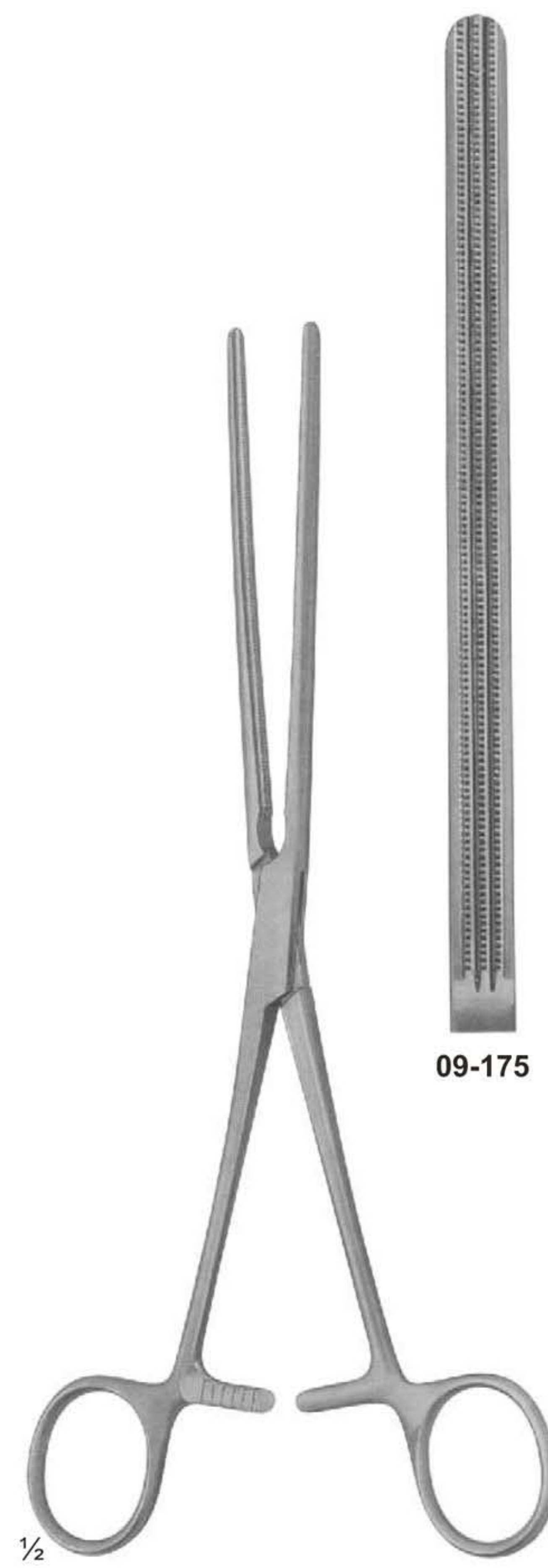

**09-175 - 176**  
DOYEN  
with elastic blades  
230 mm

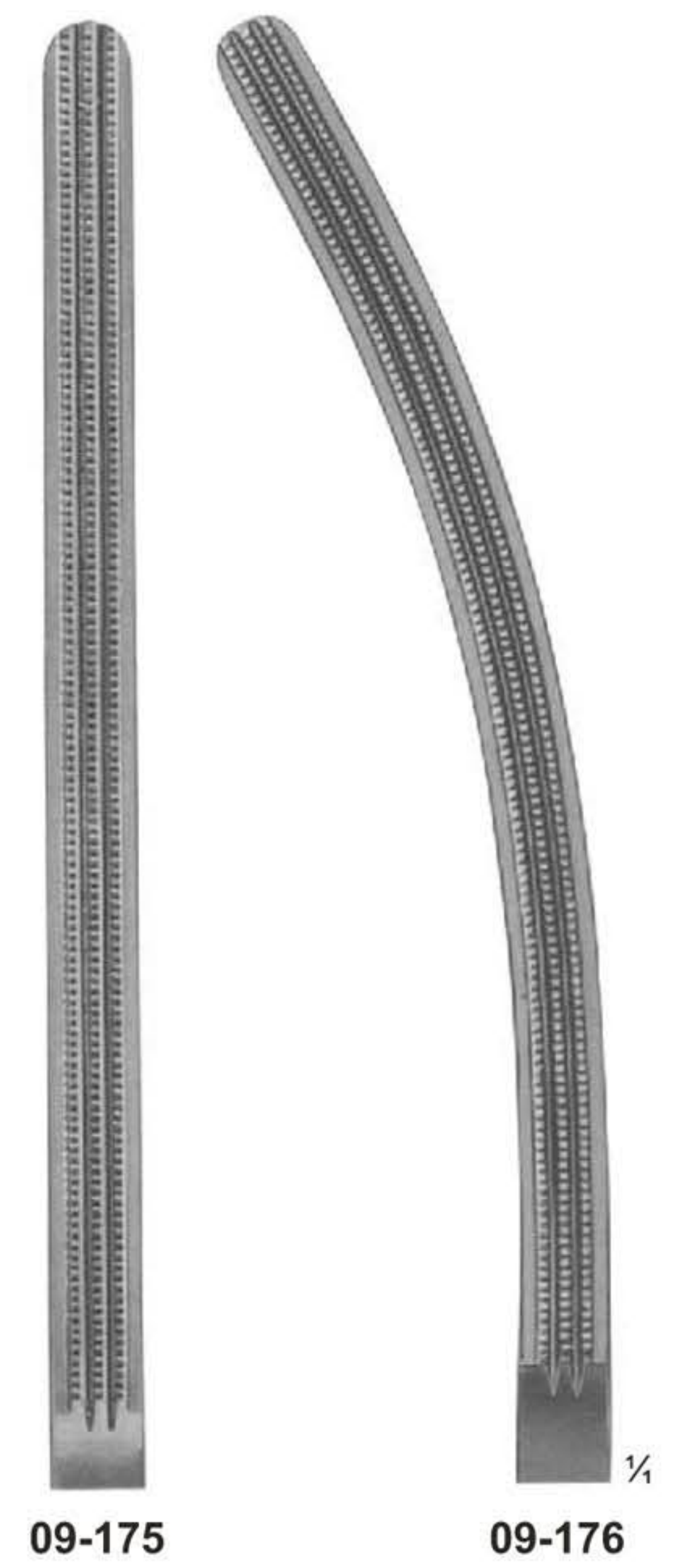

**09-176**



**Intestinal Clamps, Soft elastic**

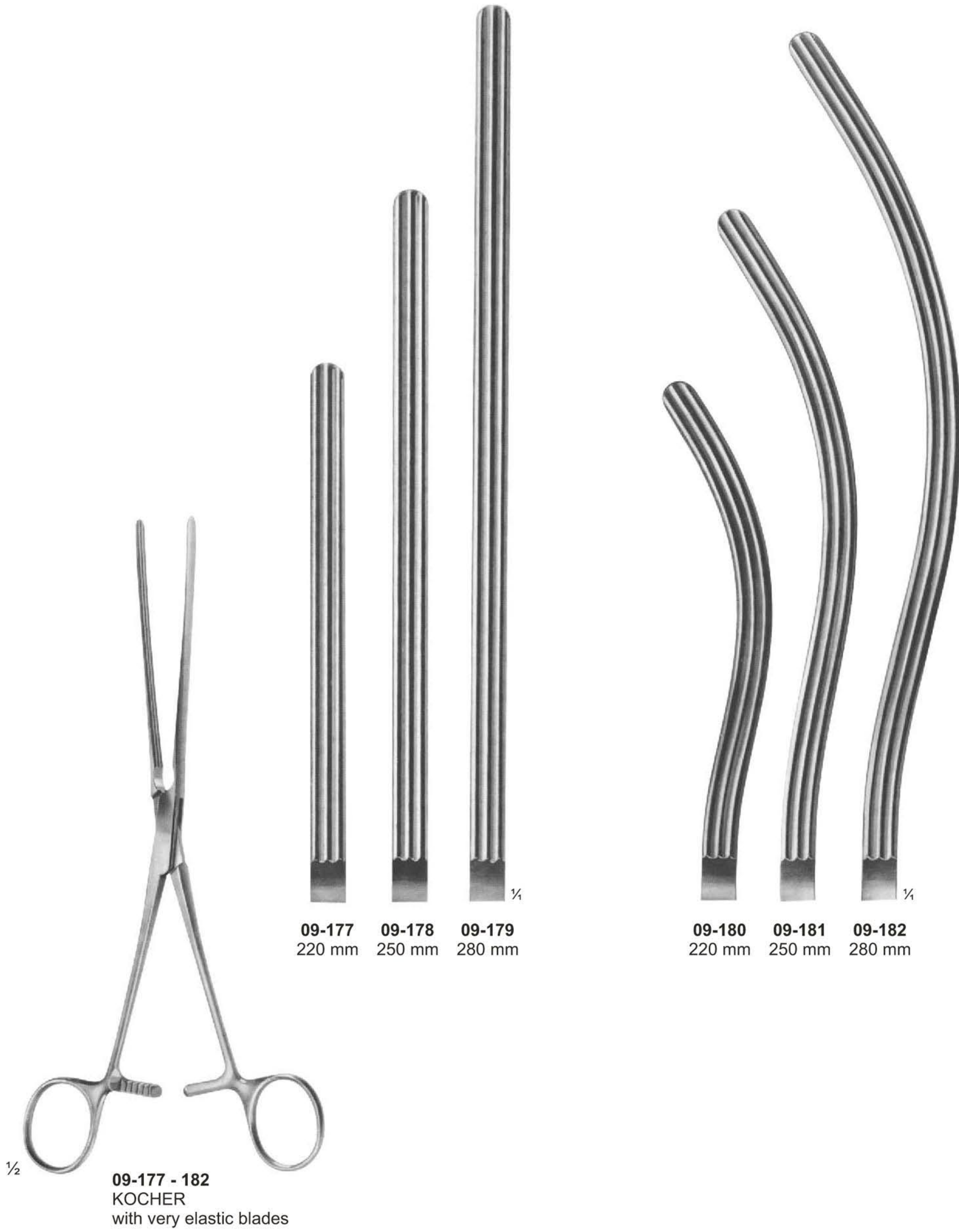



# Intestinal Clamps, Soft elastic



1/2

**09-183 - 188**  
KOCHER  
with very elastic blades

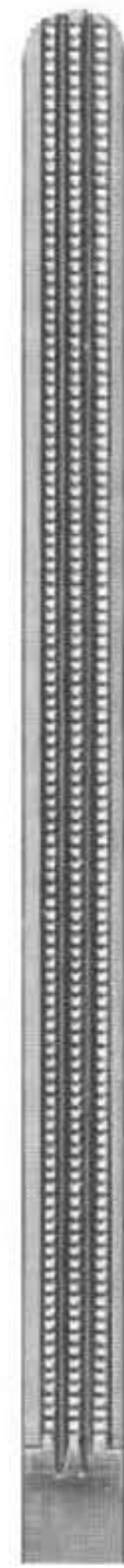

**09-183**  
220 mm

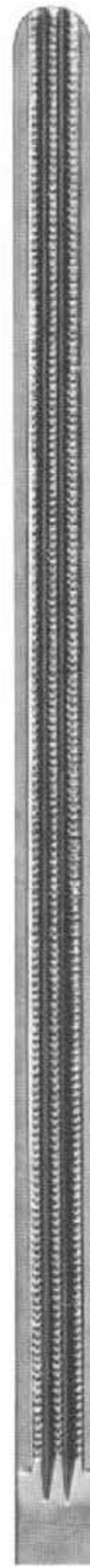

**09-184**  
250 mm



**09-185**  
280 mm

1/4



**09-186**  
220 mm



**09-187**  
250 mm



**09-188**  
280 mm

1/4



## Intestinal Clamps





# Intestinal Clamps

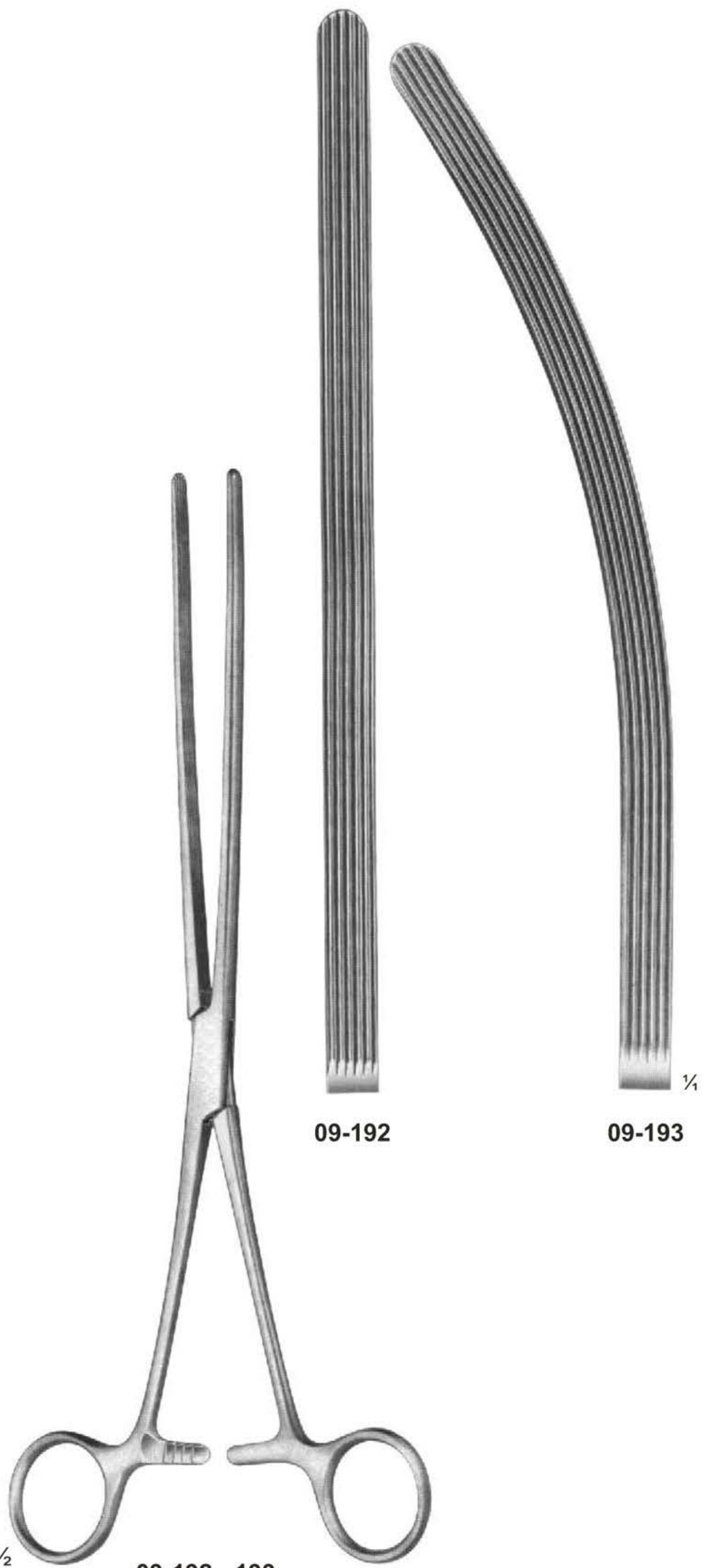

09-192

09-193

**09-192 - 193**  
MAYO-ROBSON  
hard elastic  
250 mm

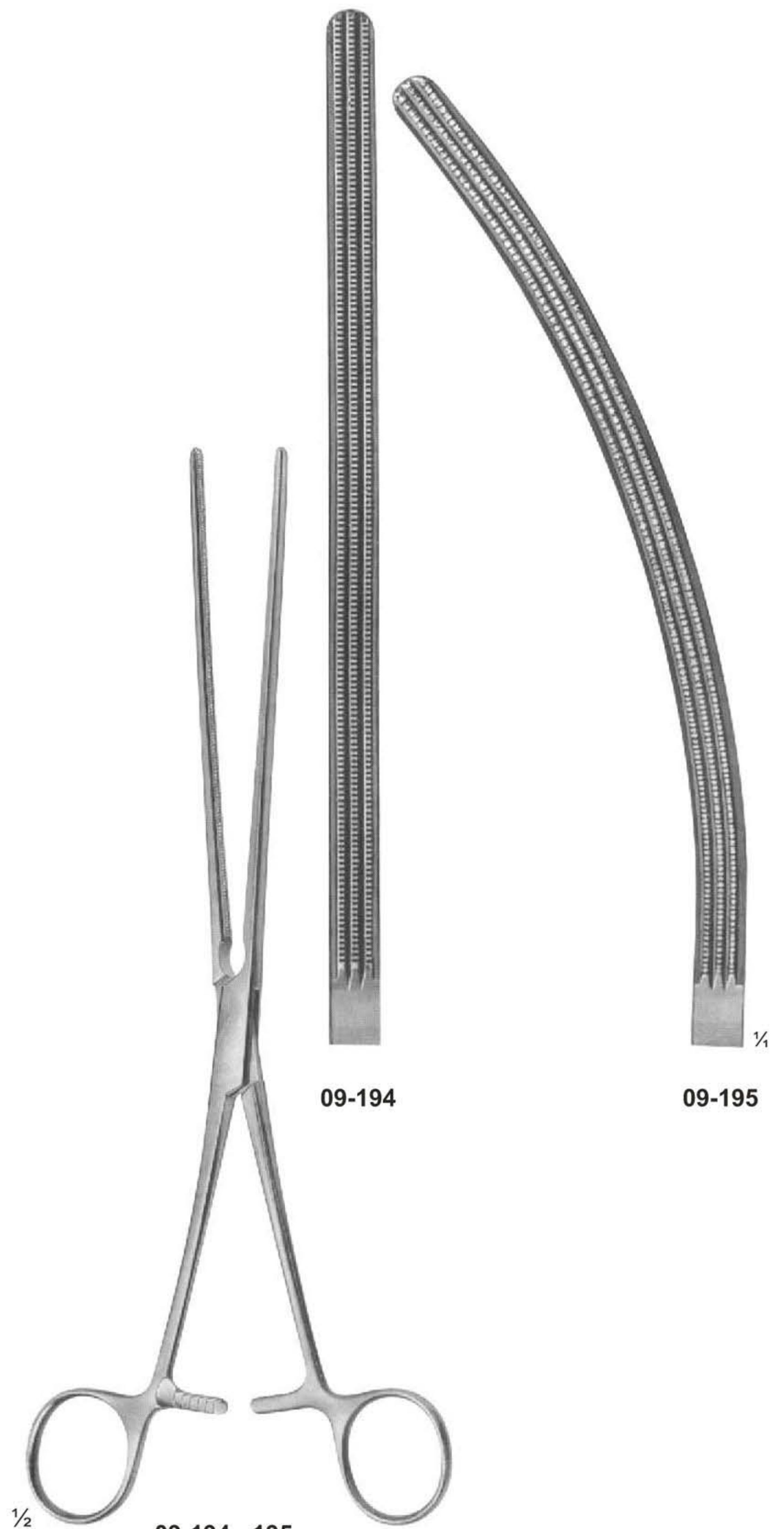

09-194

09-195

**09-194 - 195**  
MAYO-ROBSON  
250 mm



## Gastro-Intestinal Forceps, twin



**09-196**  
LANE  
300 mm

**09-197**  
LANE  
300 mm



**Stomach Clamps**



**09-198**

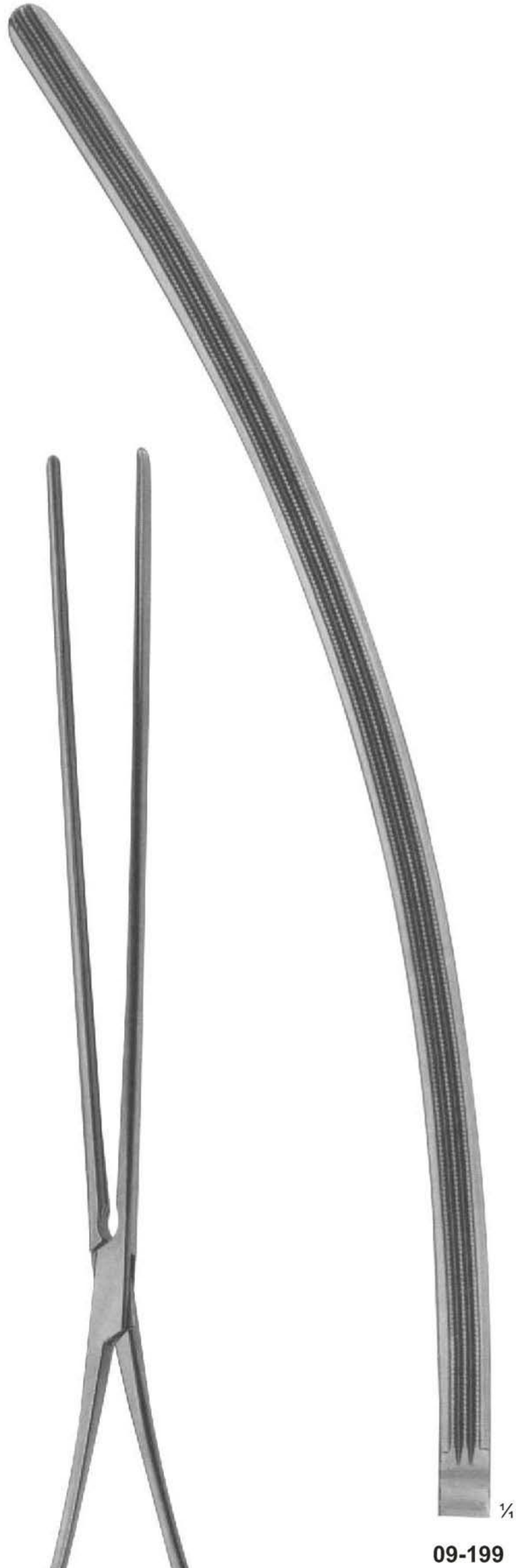

**09-199**

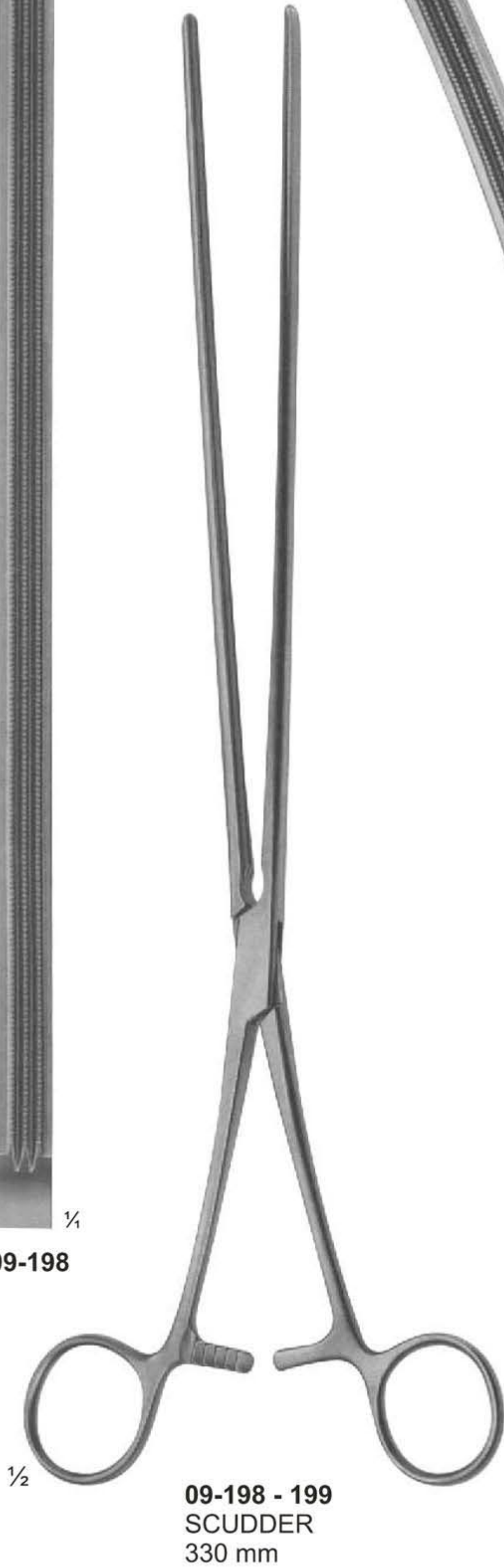

**09-198 - 199**  
SCUDDER  
330 mm



**09-200**  
KLEINSCHMIDT  
Spur crushers and  
Appendectomy clamps  
130 mm



# Intestinal and Pylorus Clamps



**09-201**  
PAYR  
Intestinal clamp  
light pattern,  
for children  
180 mm

**09-202**  
PAYR  
200 mm

**09-203**  
PAYR  
275 mm

**09-204**  
PAYR  
Pylorus clamp  
315 mm



# Anastomosis Forceps



**09-205**  
PARKER-KERR  
anastomosis forceps  
for colon resection  
180 mm

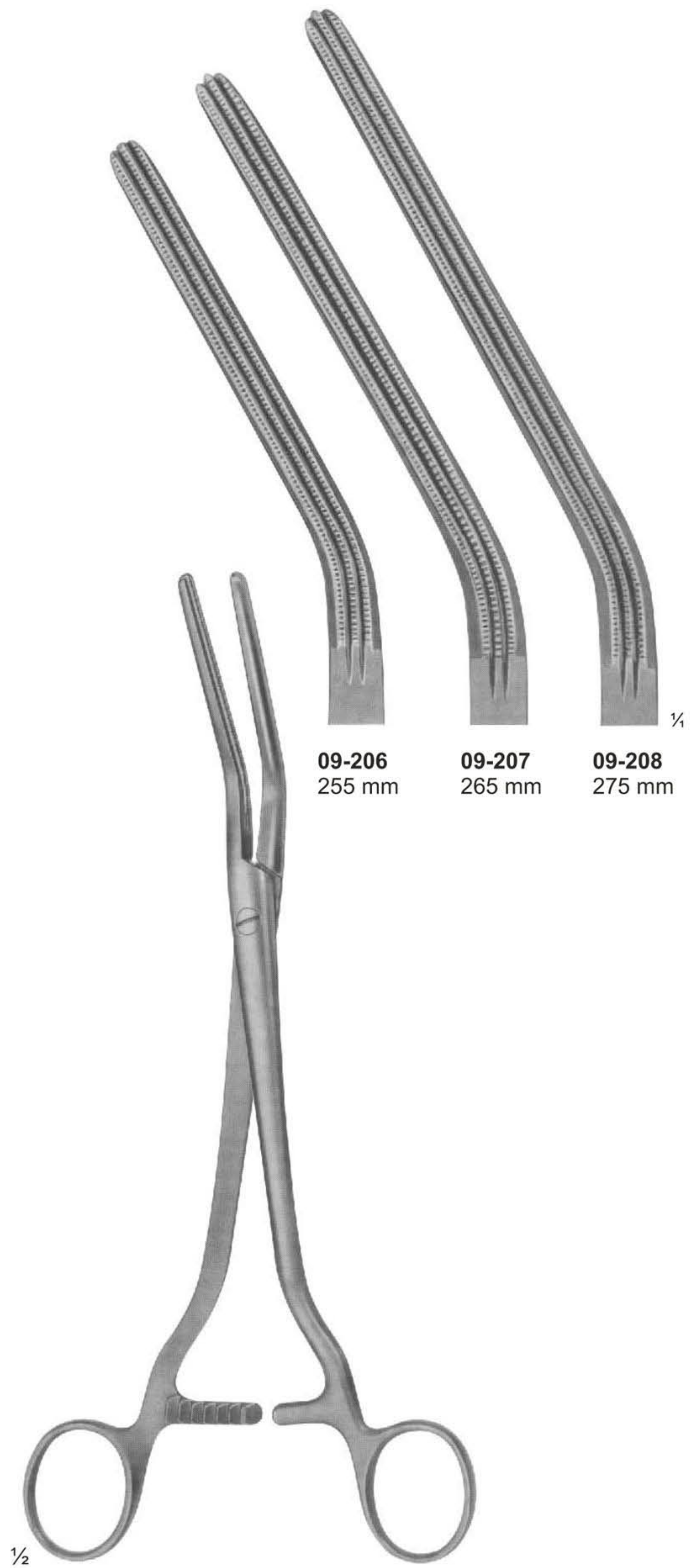

**09-206** 255 mm  
**09-207** 265 mm  
**09-208** 275 mm

**09-206 - 208**  
DICK  
pressure clamps  
180 mm



# Sigmoid Anastomosis Forceps





# Sigmoid Anastomosis Forceps

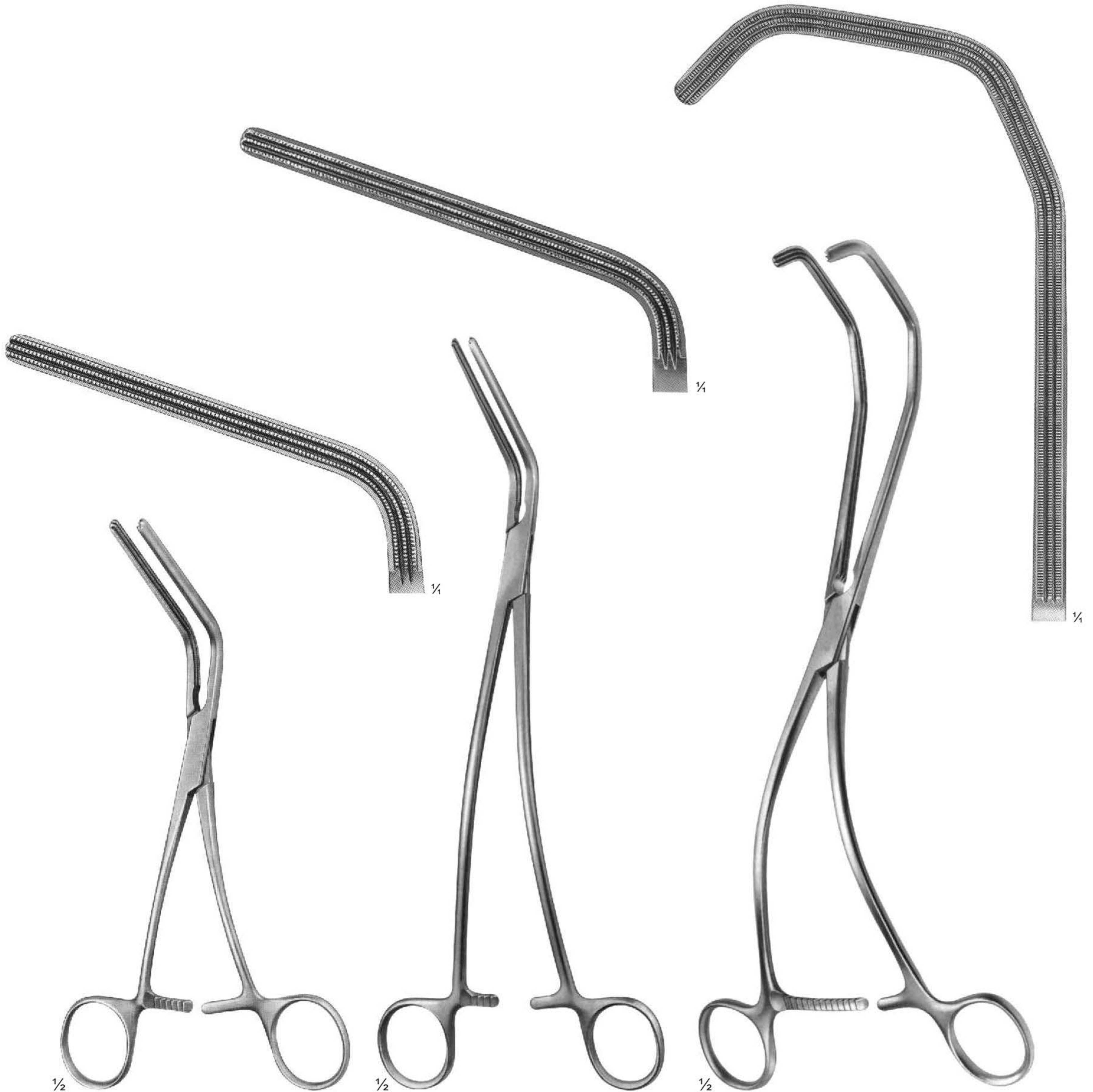

1/2

**09-212**  
MORRIS  
175 mm

1/2

**09-213**  
DE BAKEY  
(MORRIS modif.)  
240 mm

1/2

**09-214**  
KERSTING  
270 mm



# Rectal Specula

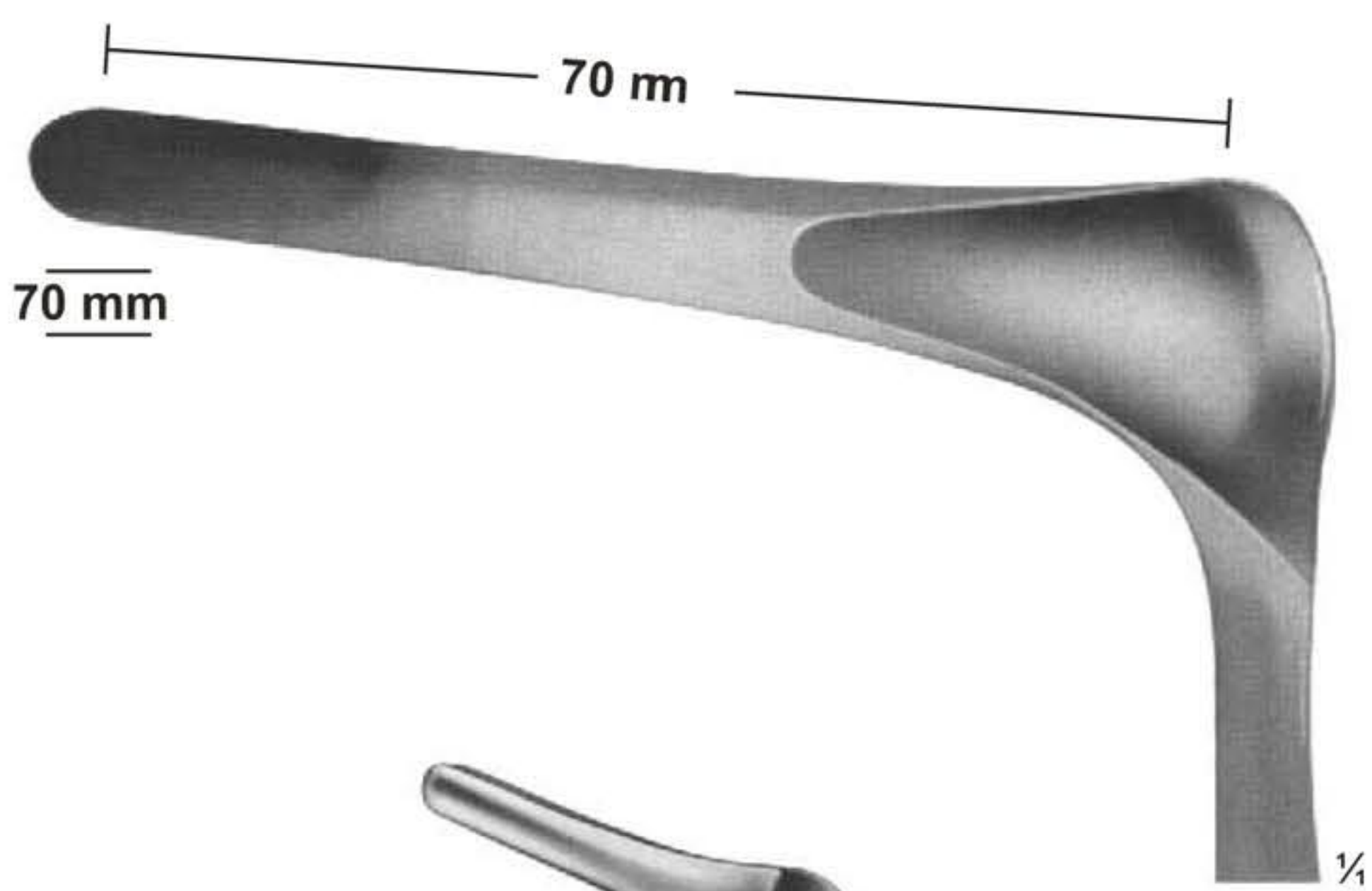

**10-101**  
KILLIAN  
for children  
145 mm



**10-102**  
SIMS  
160 mm



**10-103**  
SIMS  
160 mm



# Rectal Specula

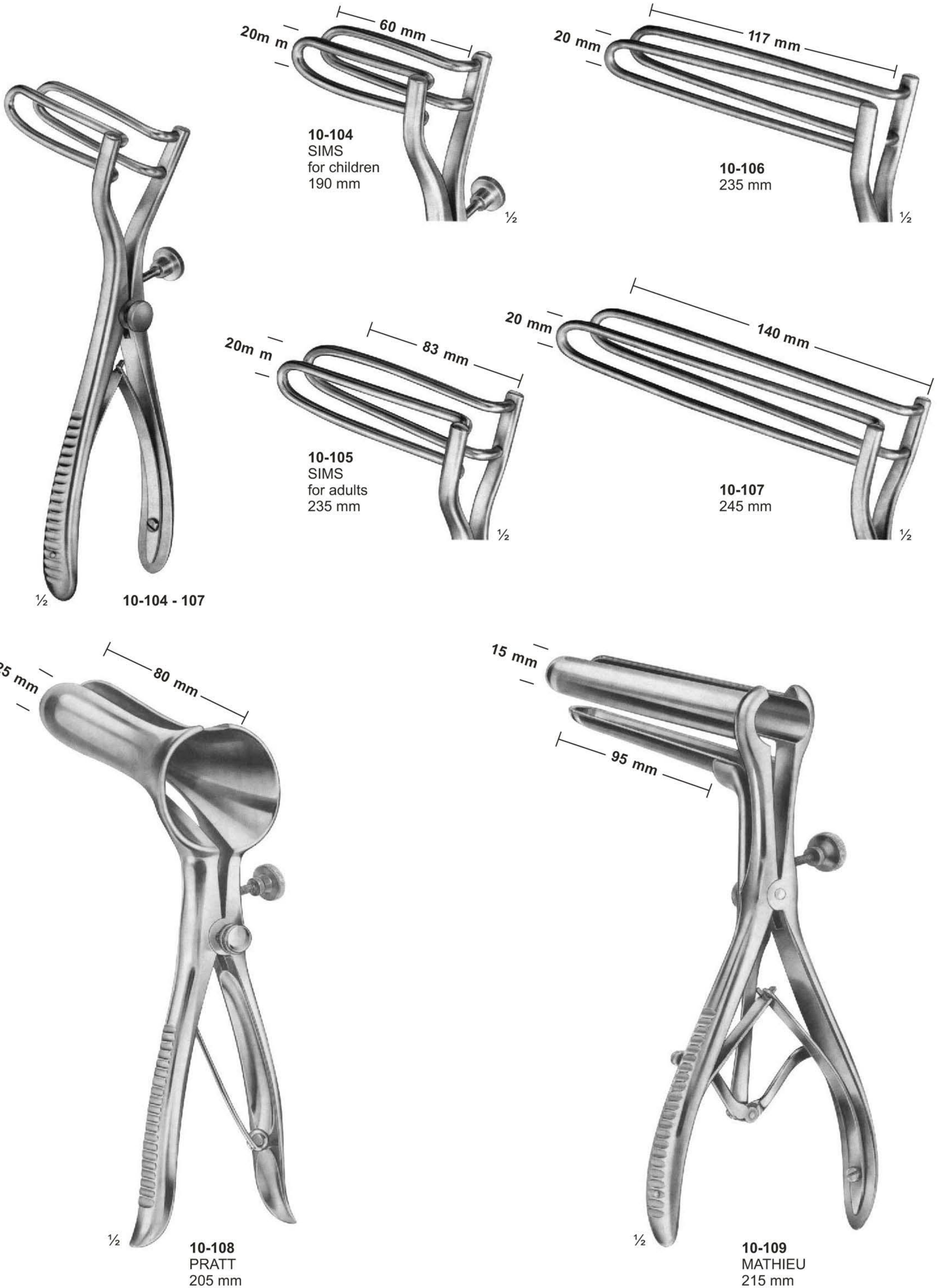



# Anuscopes-Sphincteroscopes



**10-110**  
IVES-FANSLER  
Anuscops  
145 mm



**10-111**  
KELLY  
Sphincteroscope  
160 mm

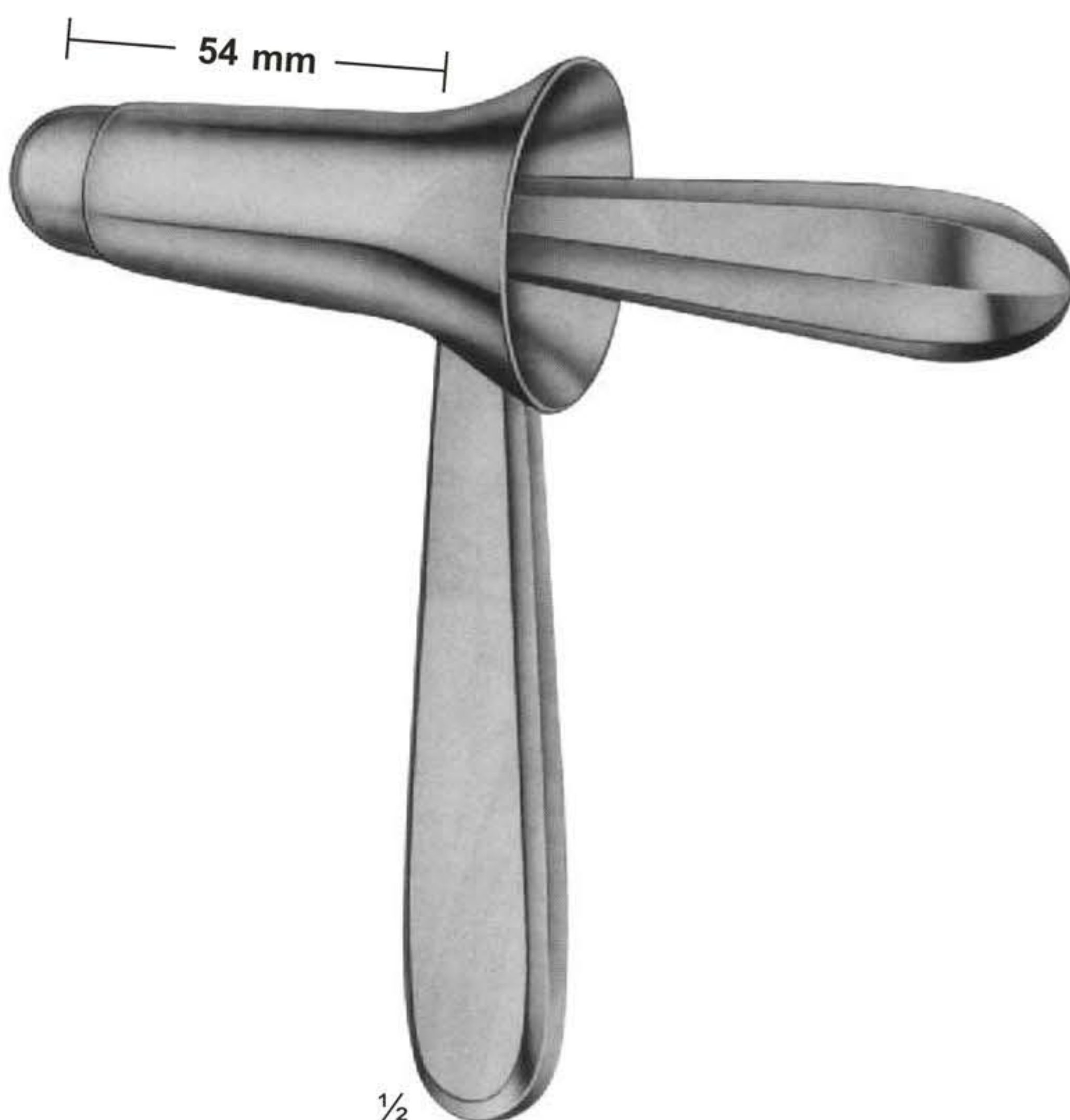

**10-112**  
KELLY  
Sphincteroscope  
160 mm

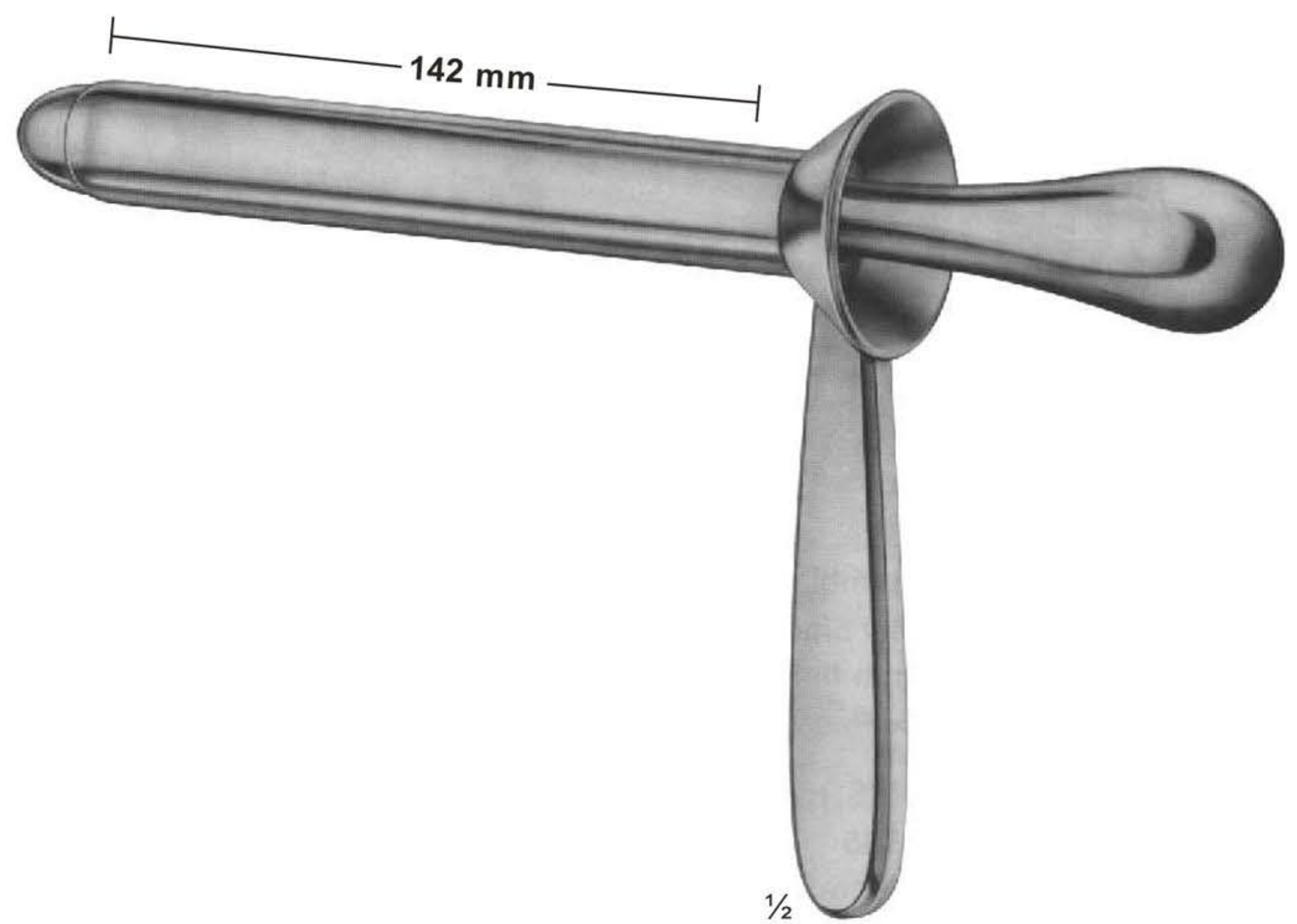

**10-113**  
KELLY  
Proctoscope  
160 mm



# Biopsy forceps for rectum

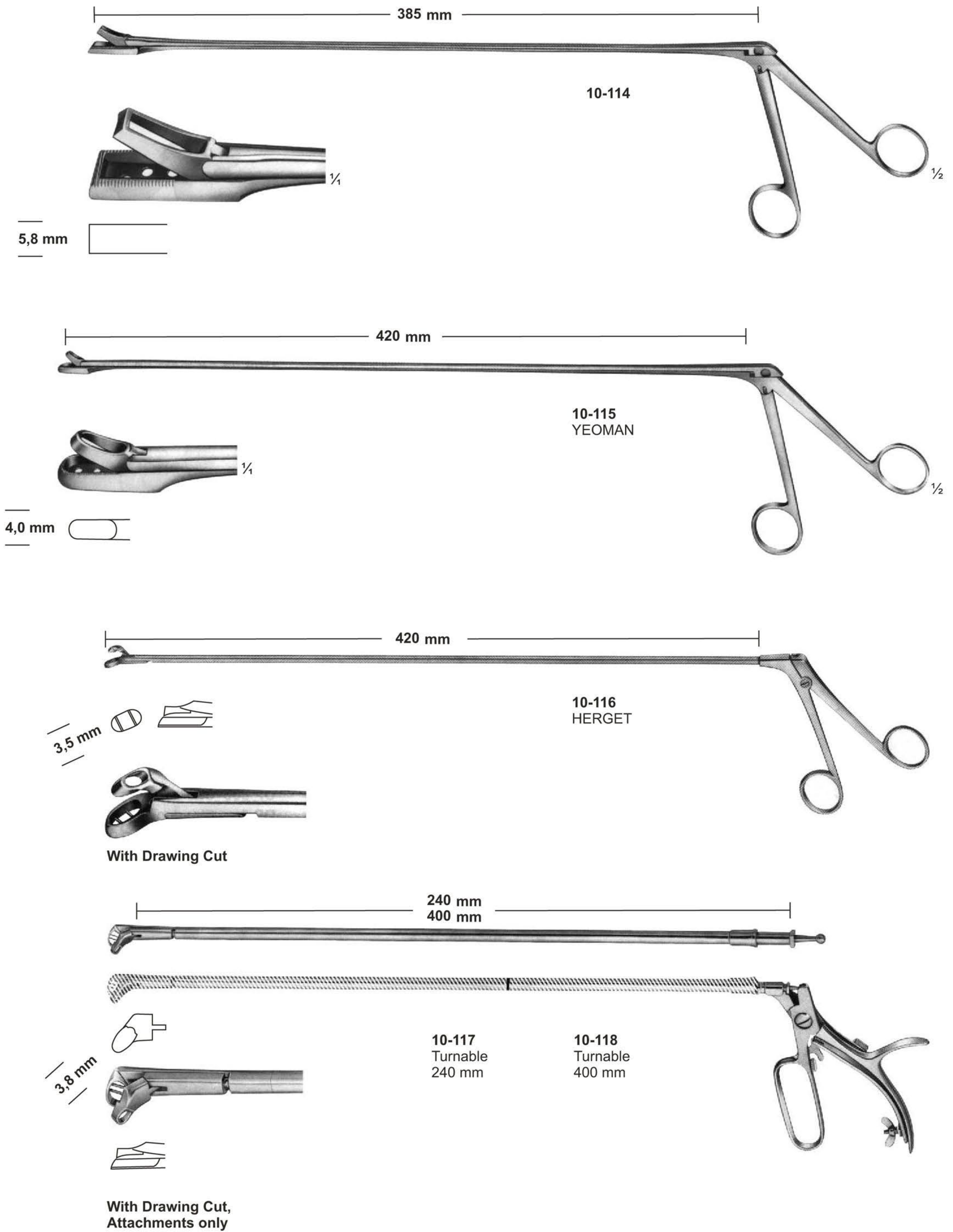



# Biopsy Forceps & Swab Holders

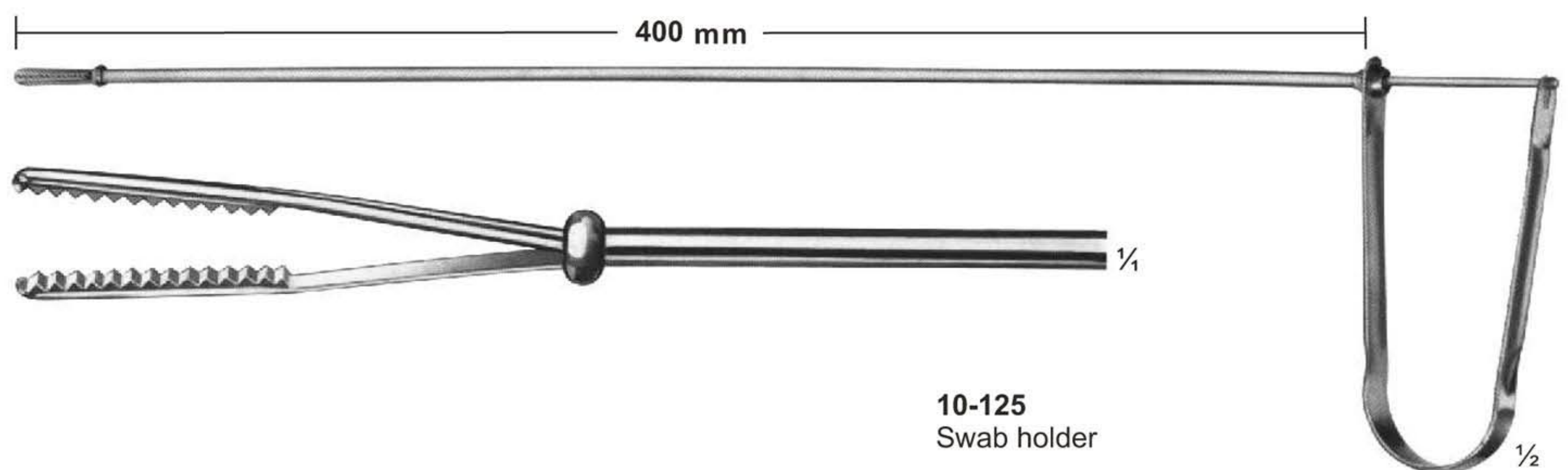
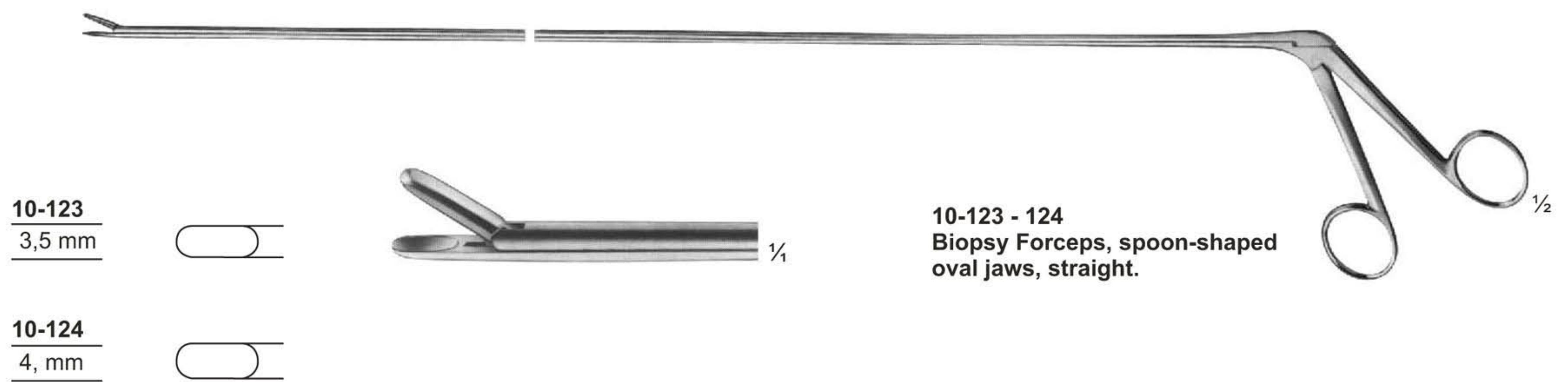
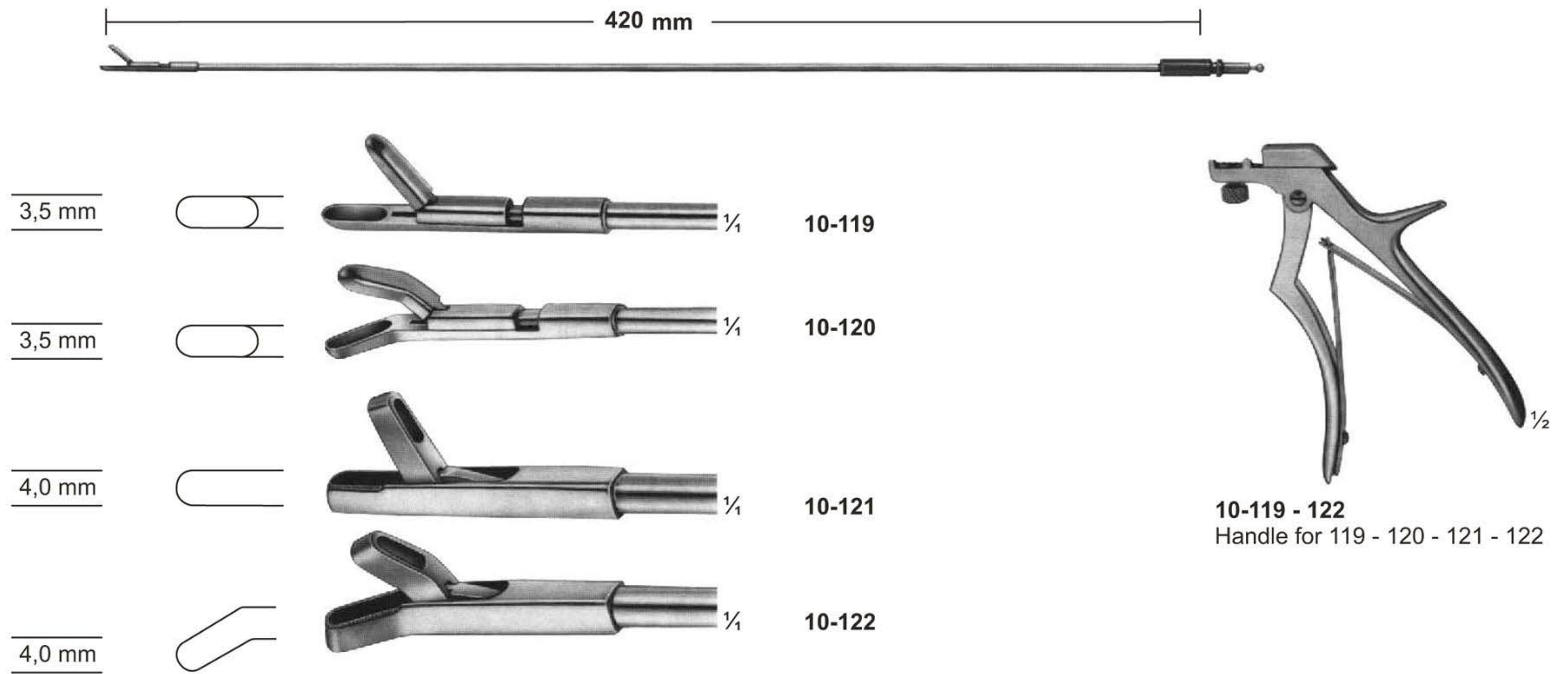



# Haemorrhoidal Forceps

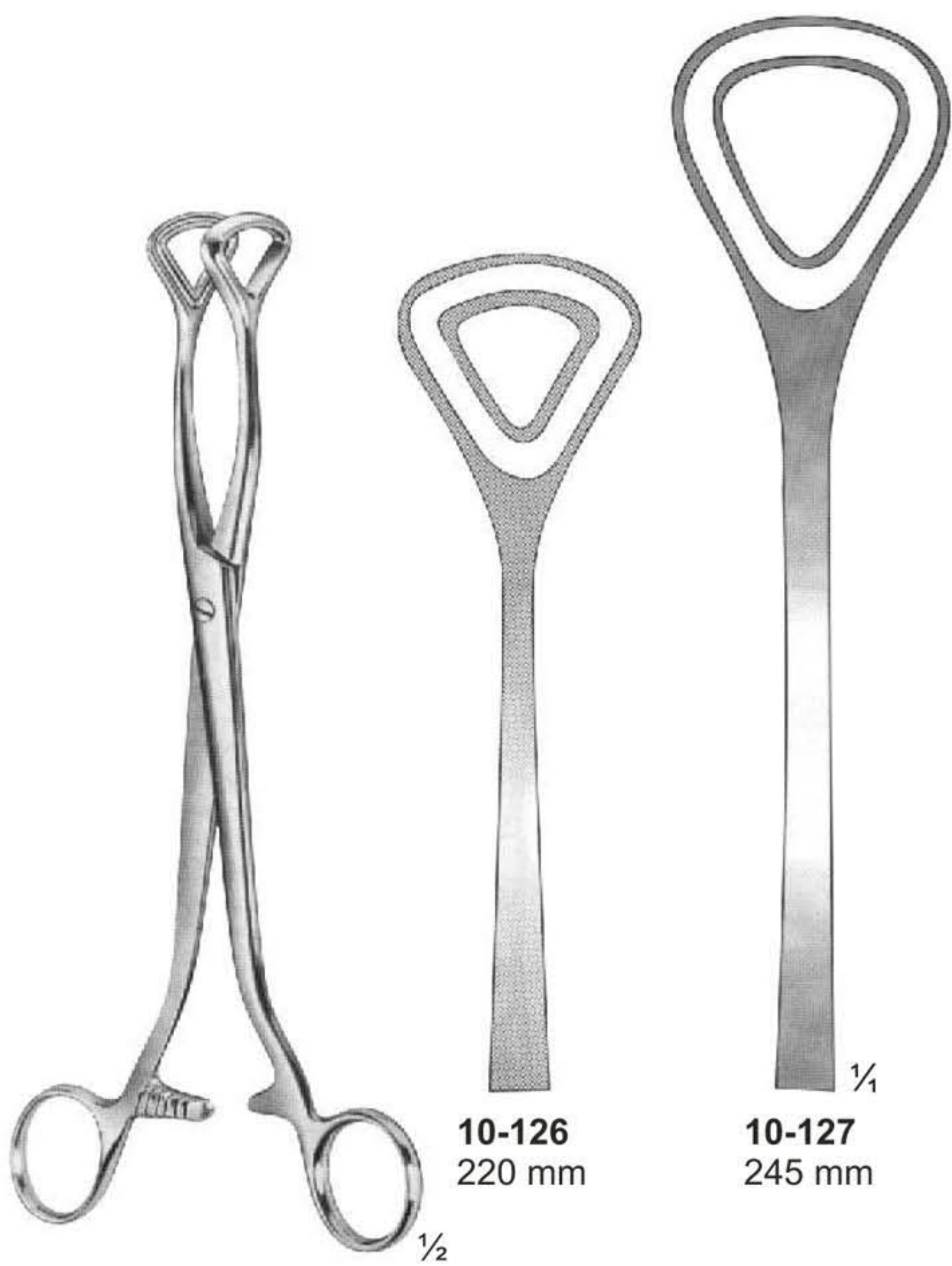

**10-126 - 127**  
LUER

**10-126**  
220 mm

**10-127**  
245 mm

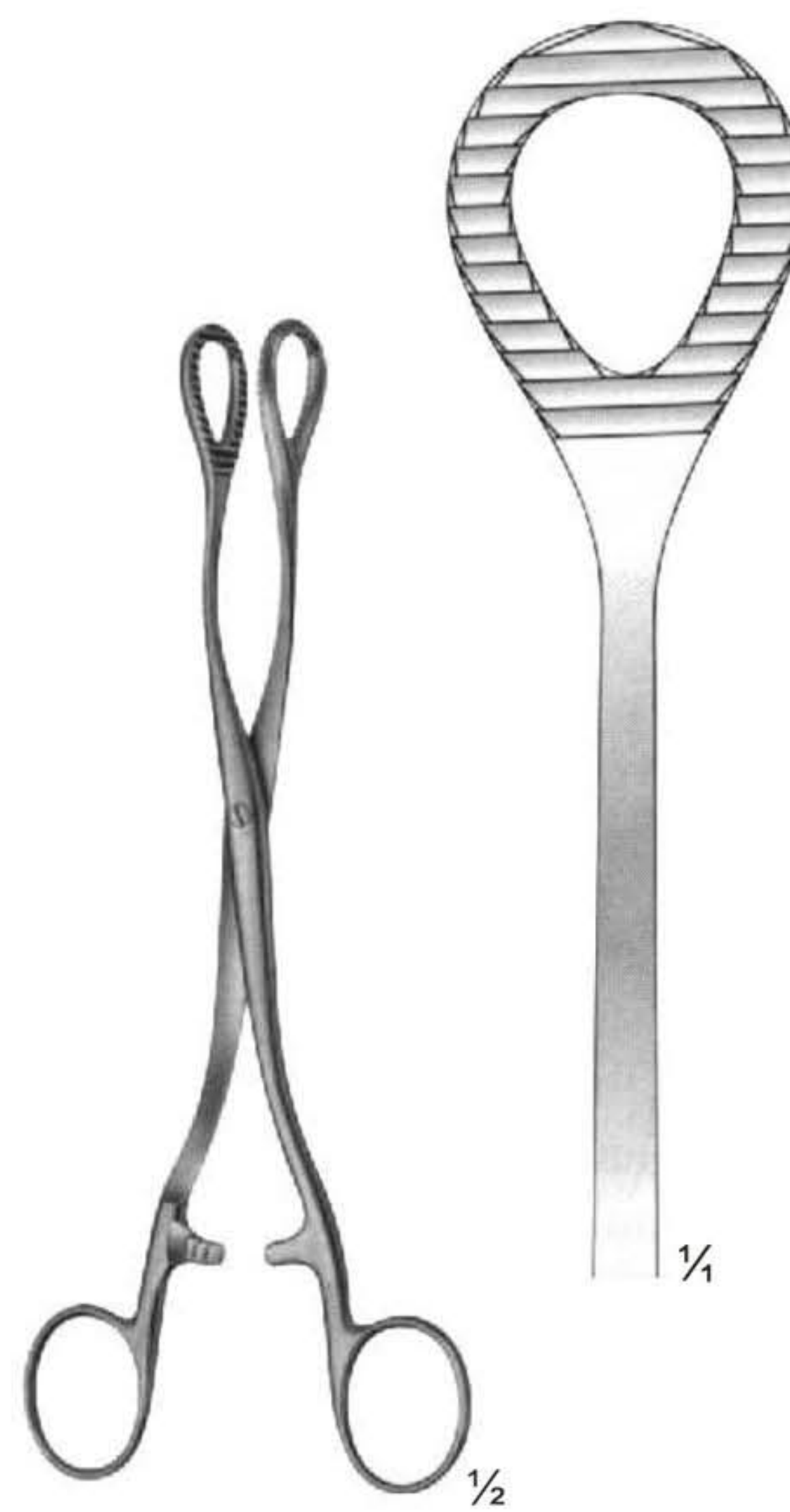

**10-128**  
HEYWOOD-SMITH  
200 mm



**10-129**  
HEYWOOD-SMITH  
modif  
200 mm



# Haemorrhoidal Forceps

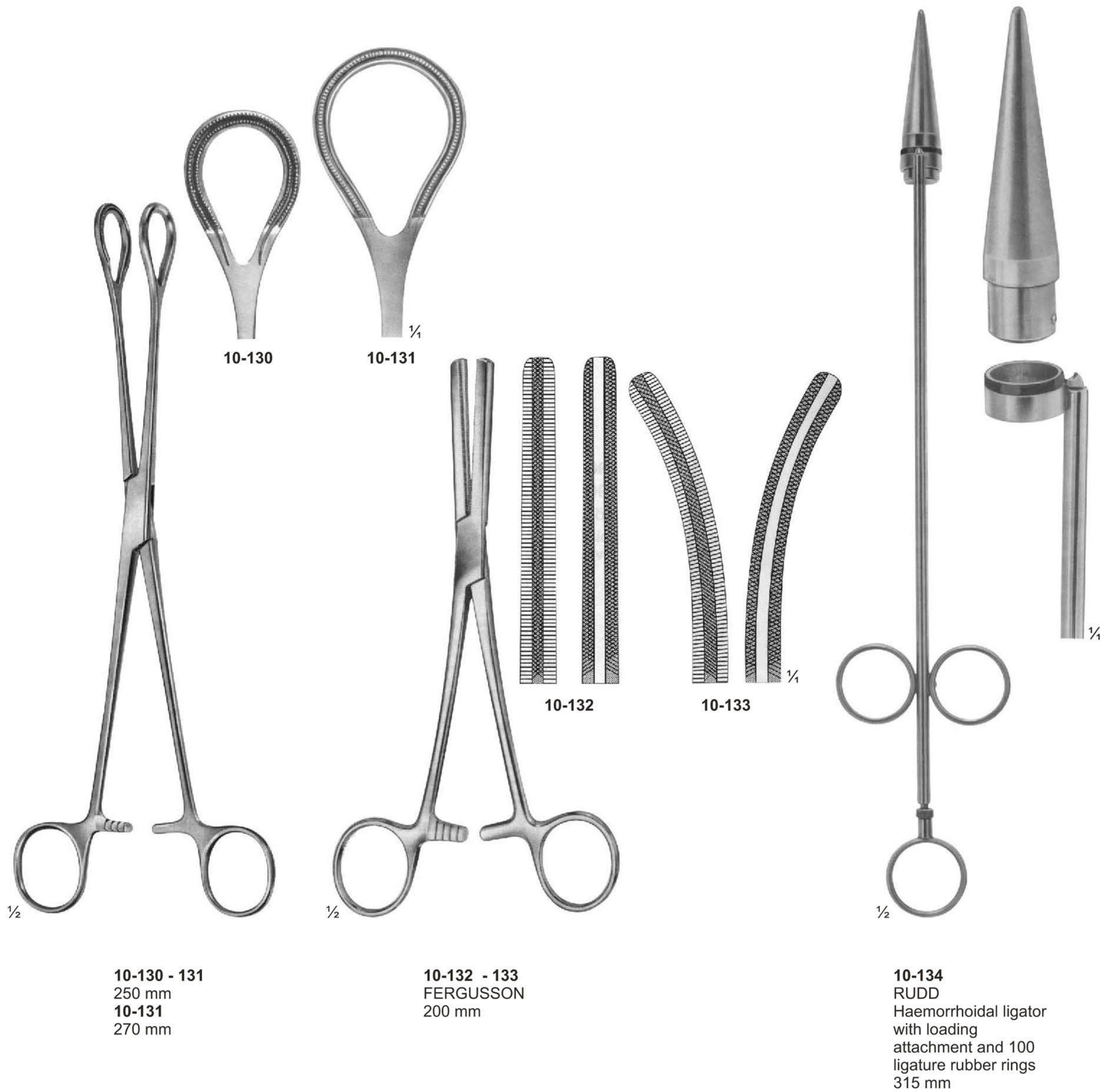



# Gall Duct Forceps



**10-135**  
LOWER  
180 mm



**10-136**  
LAHEY ( SWEET )  
190 mm

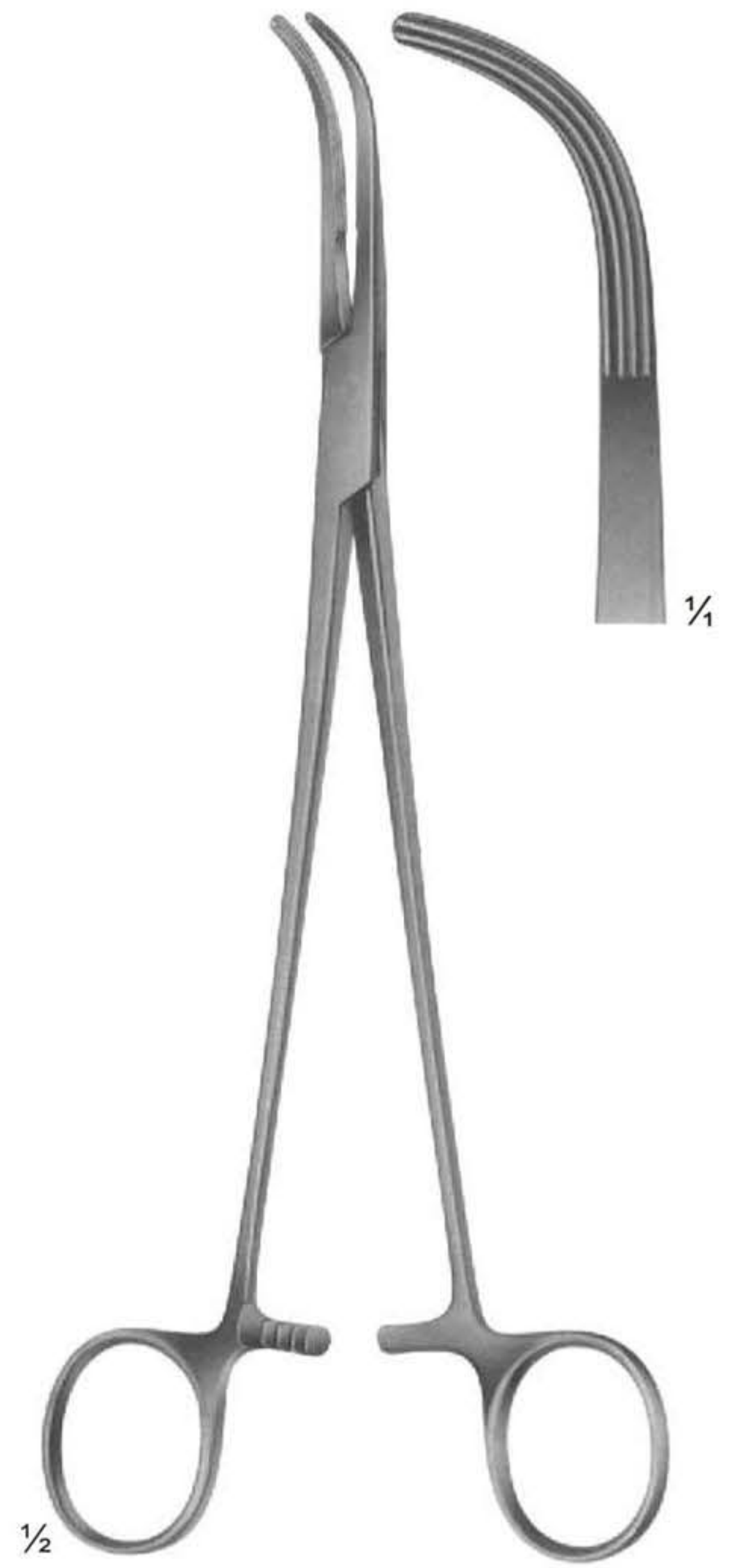

**10-137**  
LAHEY  
220 mm



**10-138**  
DESJARDINS  
Gall duct-and cystic forceps  
210 mm

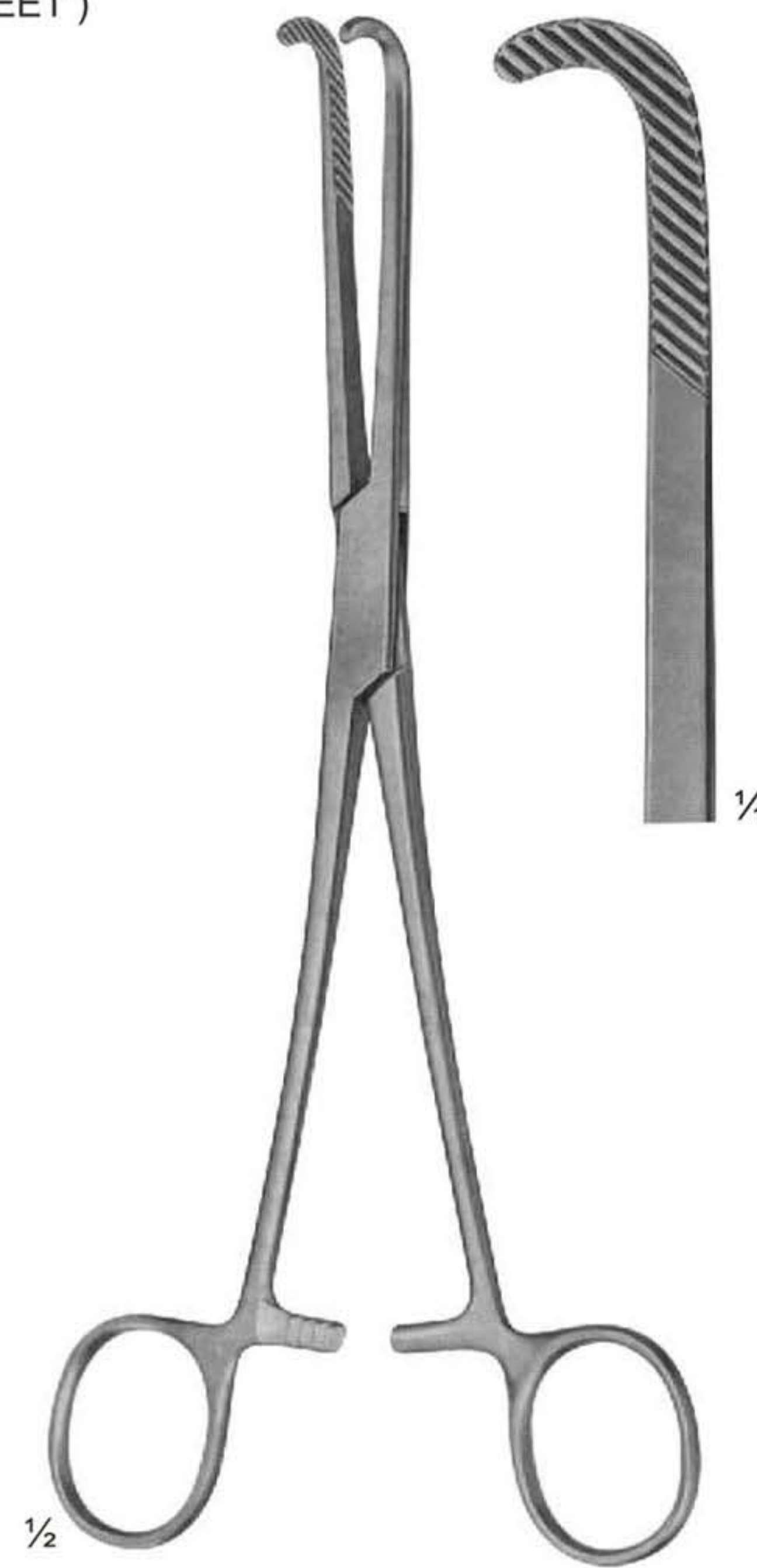

**10-139**  
NISSEN  
Gall duct-and cystic forceps  
215 mm



## Gall Duct Forceps and Choledochus Forceps

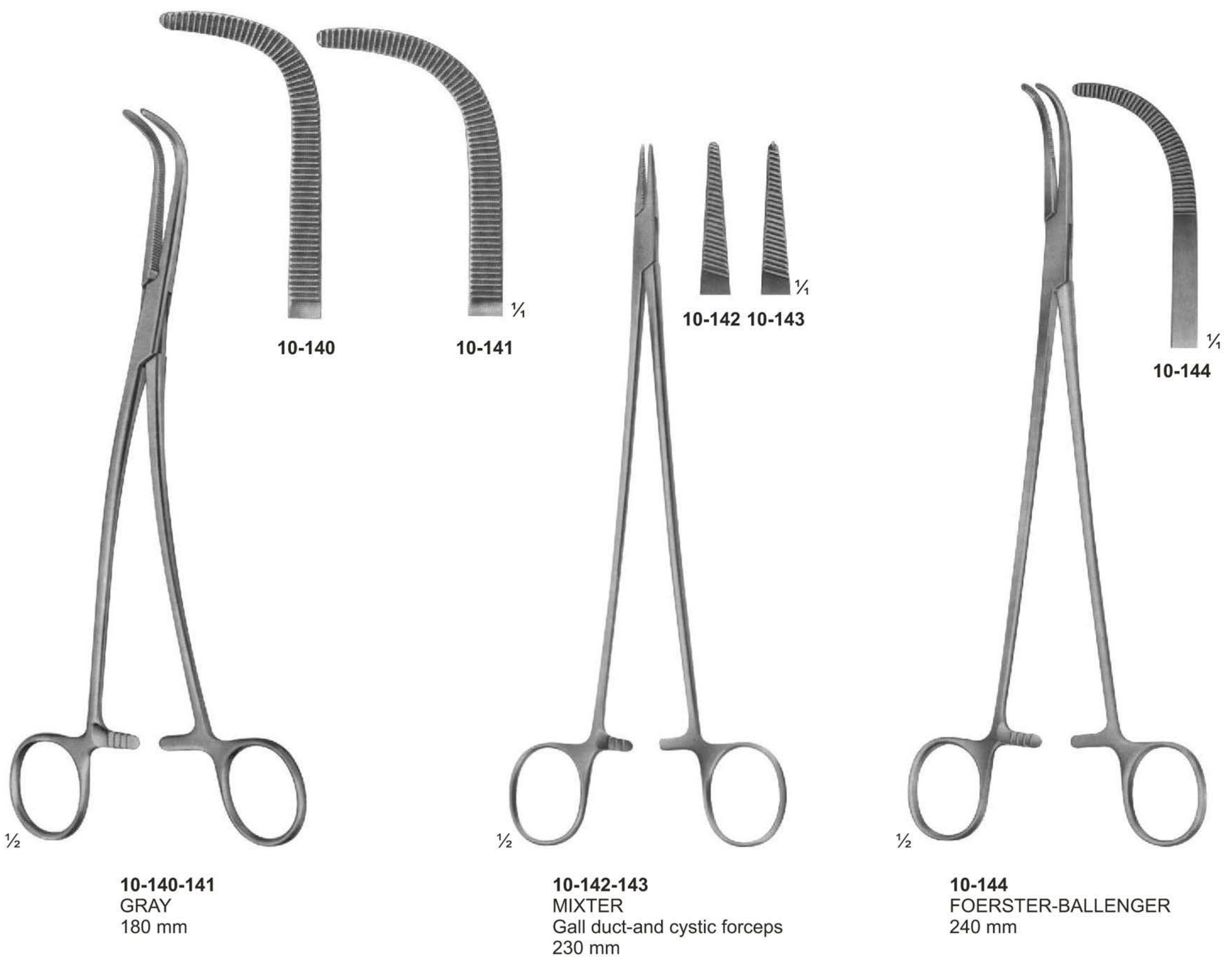



**Gall Bladder Forceps and Gall Duct Scissors**

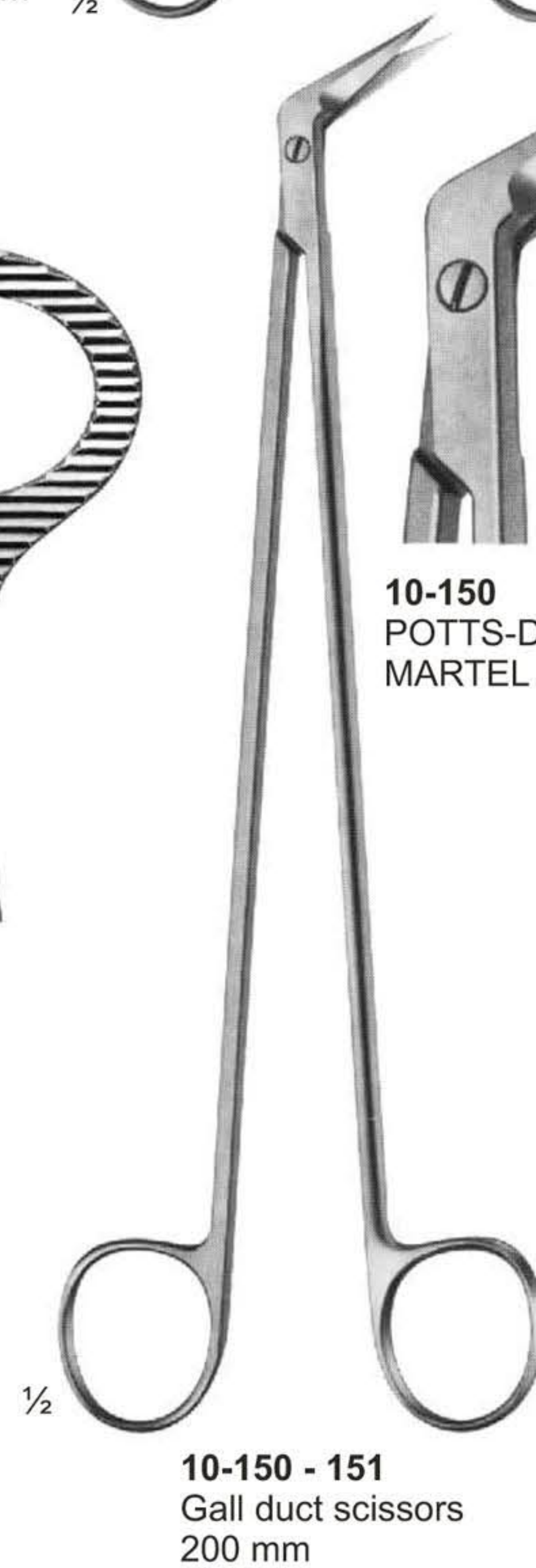
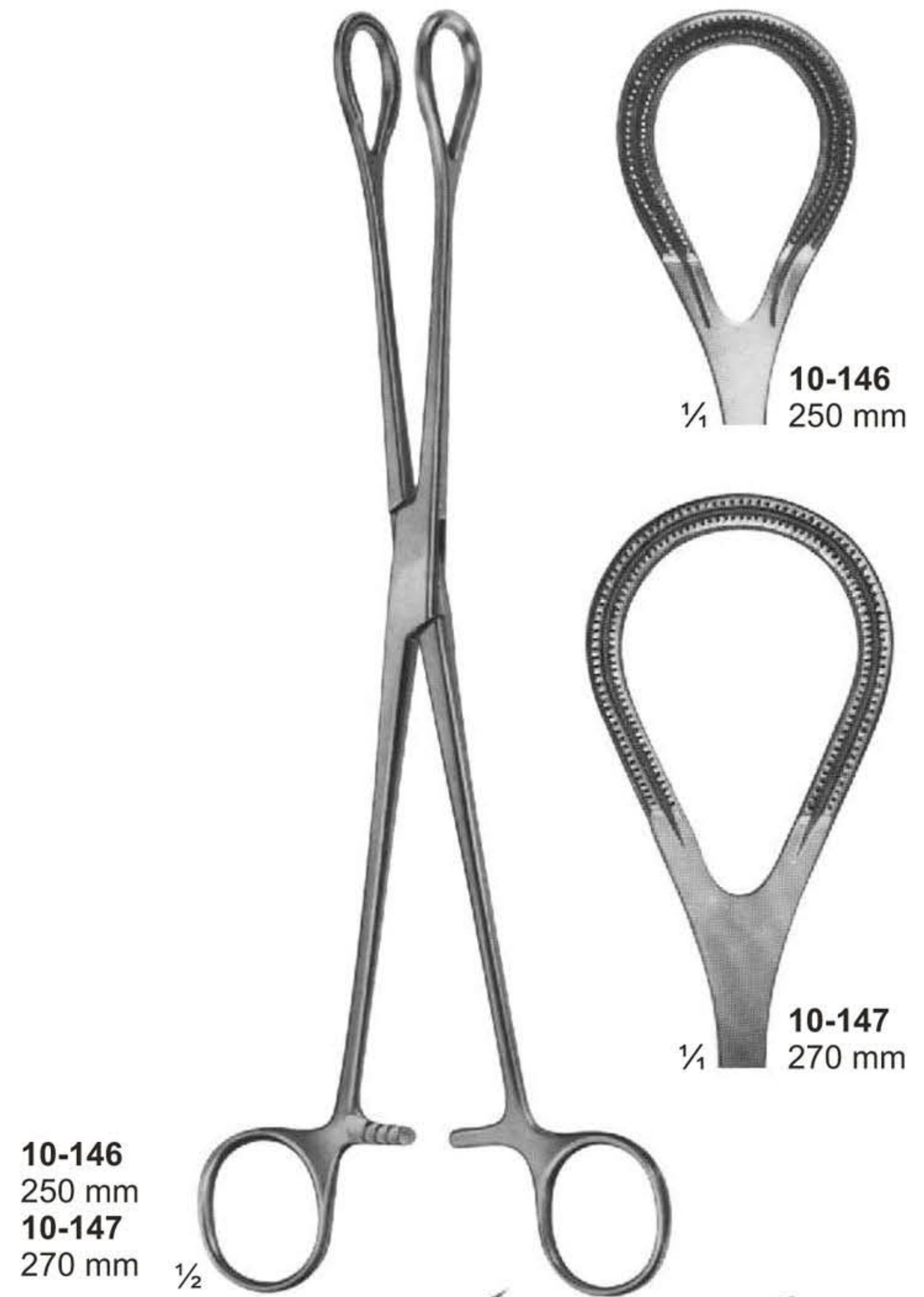
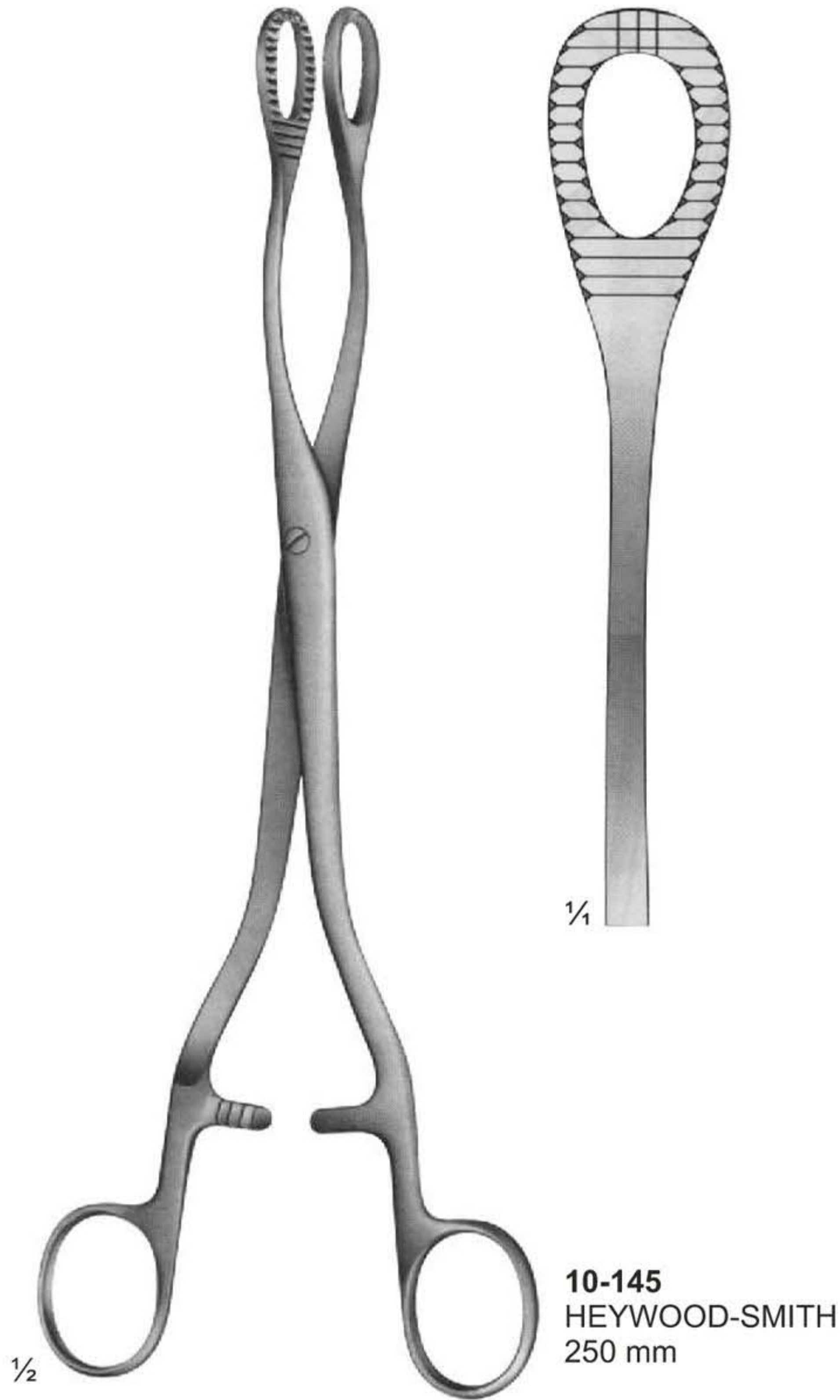



## Gall Duct Probes

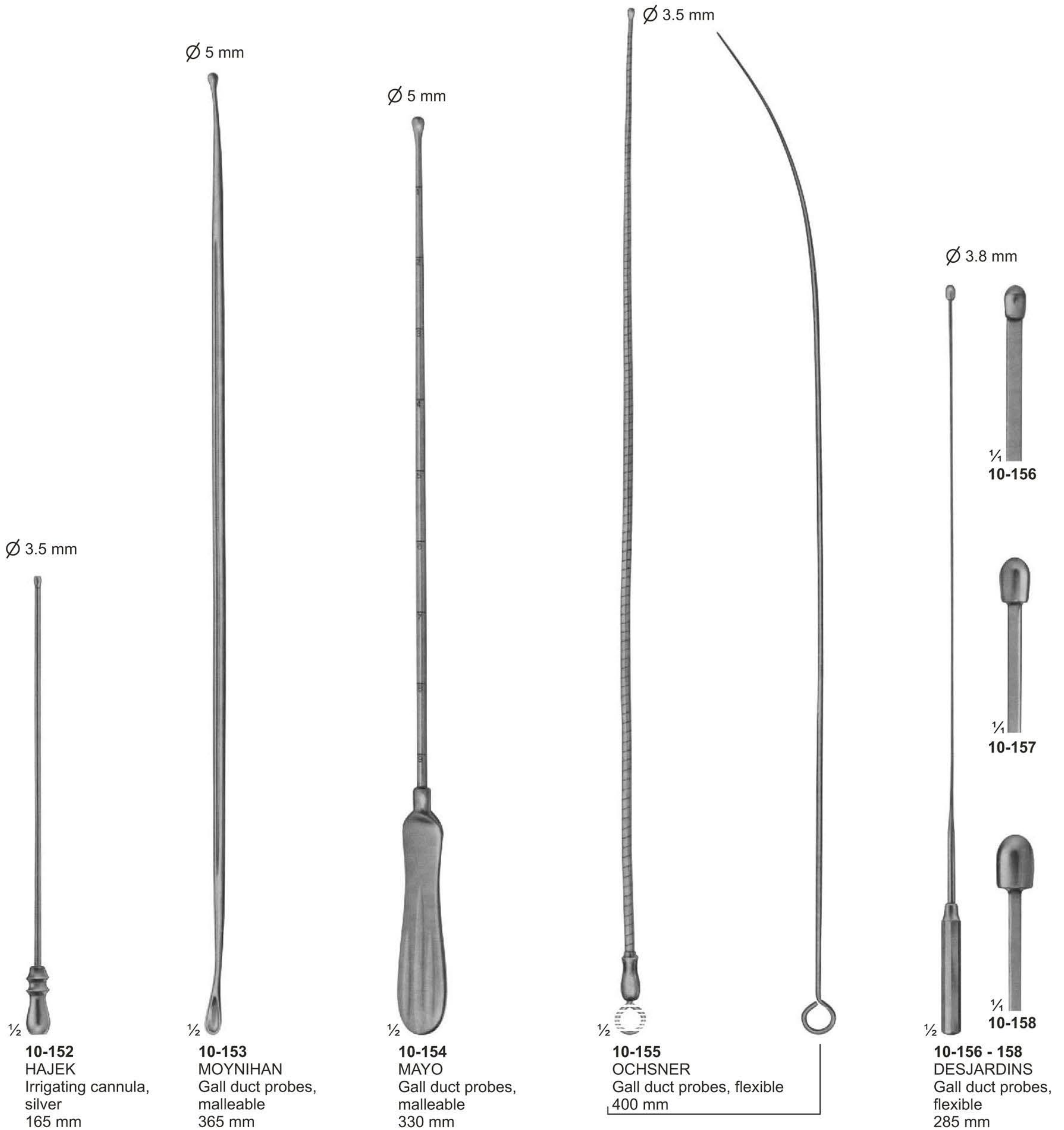



# Gall Duct Dilators & Gall Stone Scoops

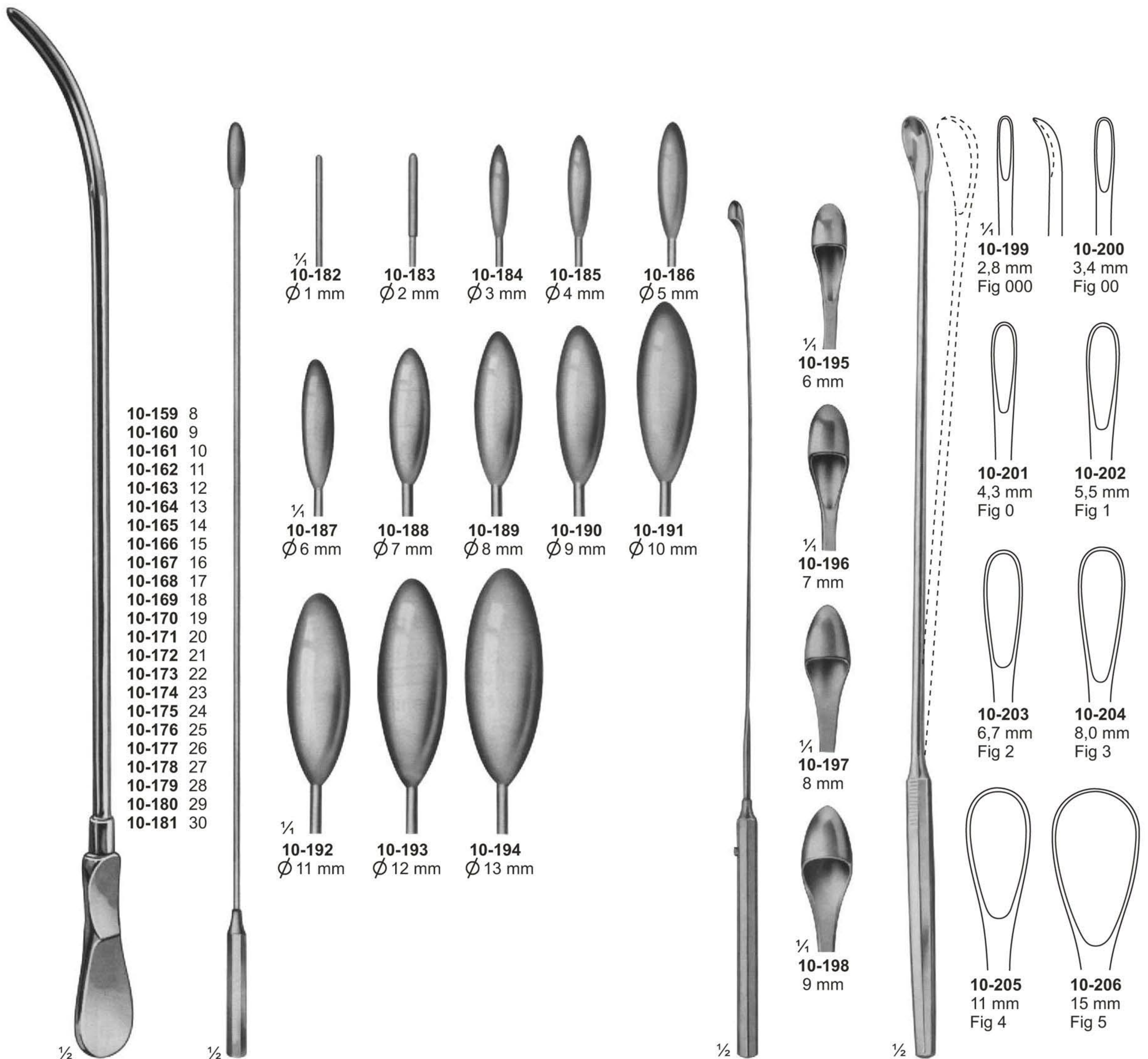

- 10-159 8
- 10-160 9
- 10-161 10
- 10-162 11
- 10-163 12
- 10-164 13
- 10-165 14
- 10-166 15
- 10-167 16
- 10-168 17
- 10-169 18
- 10-170 19
- 10-171 20
- 10-172 21
- 10-173 22
- 10-174 23
- 10-175 24
- 10-176 25
- 10-177 26
- 10-178 27
- 10-179 28
- 10-180 29
- 10-181 30

- 1/4  
10-182  
Ø 1 mm
- 10-183  
Ø 2 mm
- 10-184  
Ø 3 mm
- 10-185  
Ø 4 mm
- 10-186  
Ø 5 mm
- 1/4  
10-187  
Ø 6 mm
- 10-188  
Ø 7 mm
- 10-189  
Ø 8 mm
- 10-190  
Ø 9 mm
- 10-191  
Ø 10 mm
- 1/4  
10-192  
Ø 11 mm
- 10-193  
Ø 12 mm
- 10-194  
Ø 13 mm

- 1/4  
10-195  
6 mm
- 1/4  
10-196  
7 mm
- 1/4  
10-197  
8 mm
- 1/4  
10-198  
9 mm

- 1/4  
10-199  
2,8 mm  
Fig 000
- 10-200  
3,4 mm  
Fig 00
- 10-201  
4,3 mm  
Fig 0
- 10-202  
5,5 mm  
Fig 1
- 10-203  
6,7 mm  
Fig 2
- 10-204  
8,0 mm  
Fig 3
- 10-205  
11 mm  
Fig 4
- 10-206  
15 mm  
Fig 5

**10-159 - 181**  
**DITTEL**  
 Metall bougies and dilating sounds, stiff 345 mm

**10-182 - 194**  
**BAKES**  
 Common bile duct dilators, malleable 315 mm, 320 mm

**10-195 - 198**  
**DESJARDINS**  
 Probes and catch with flexible shaft 300 mm

**10-199 - 206**  
**LUER-KORTE modif**  
 with malleable shaft 310 mm



# Gall Stone Forceps

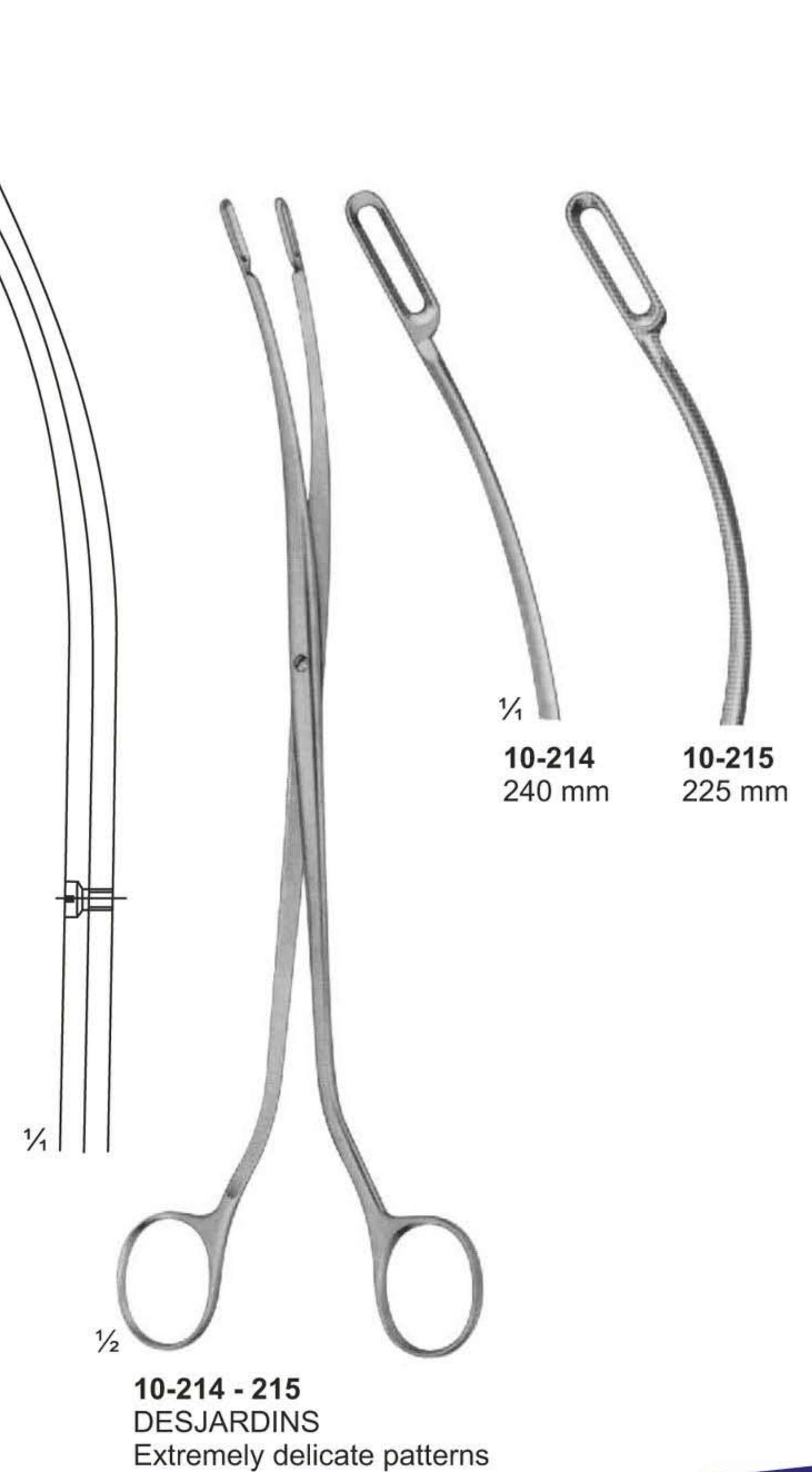
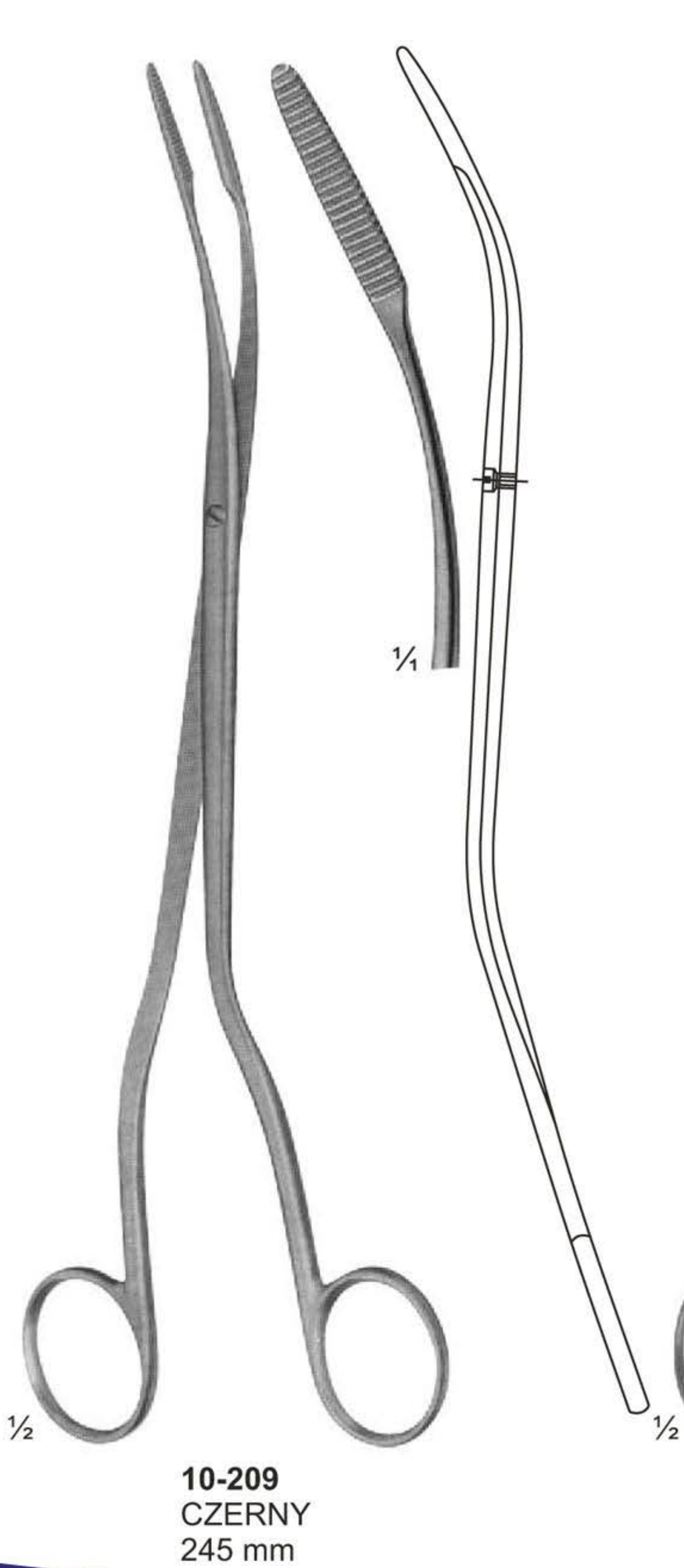
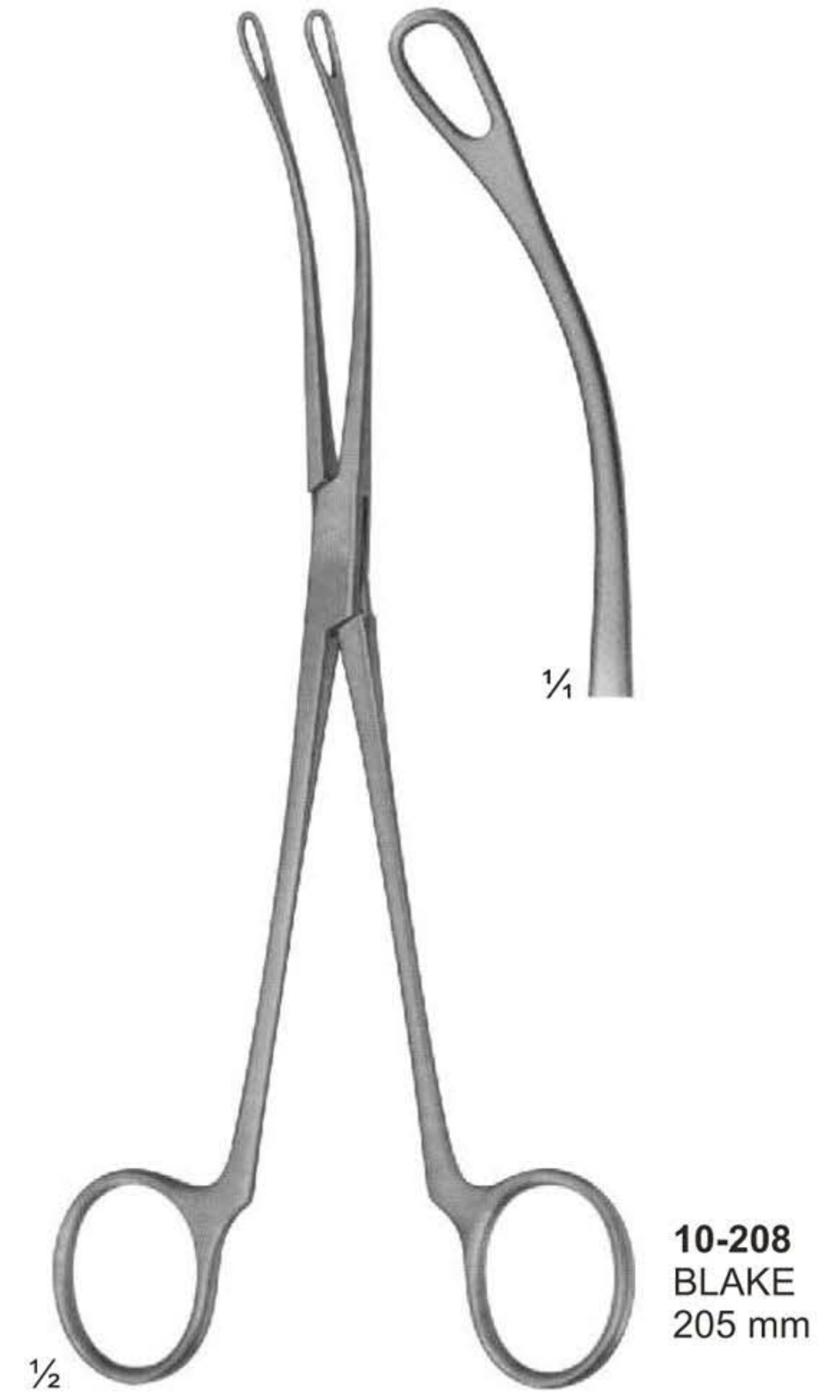
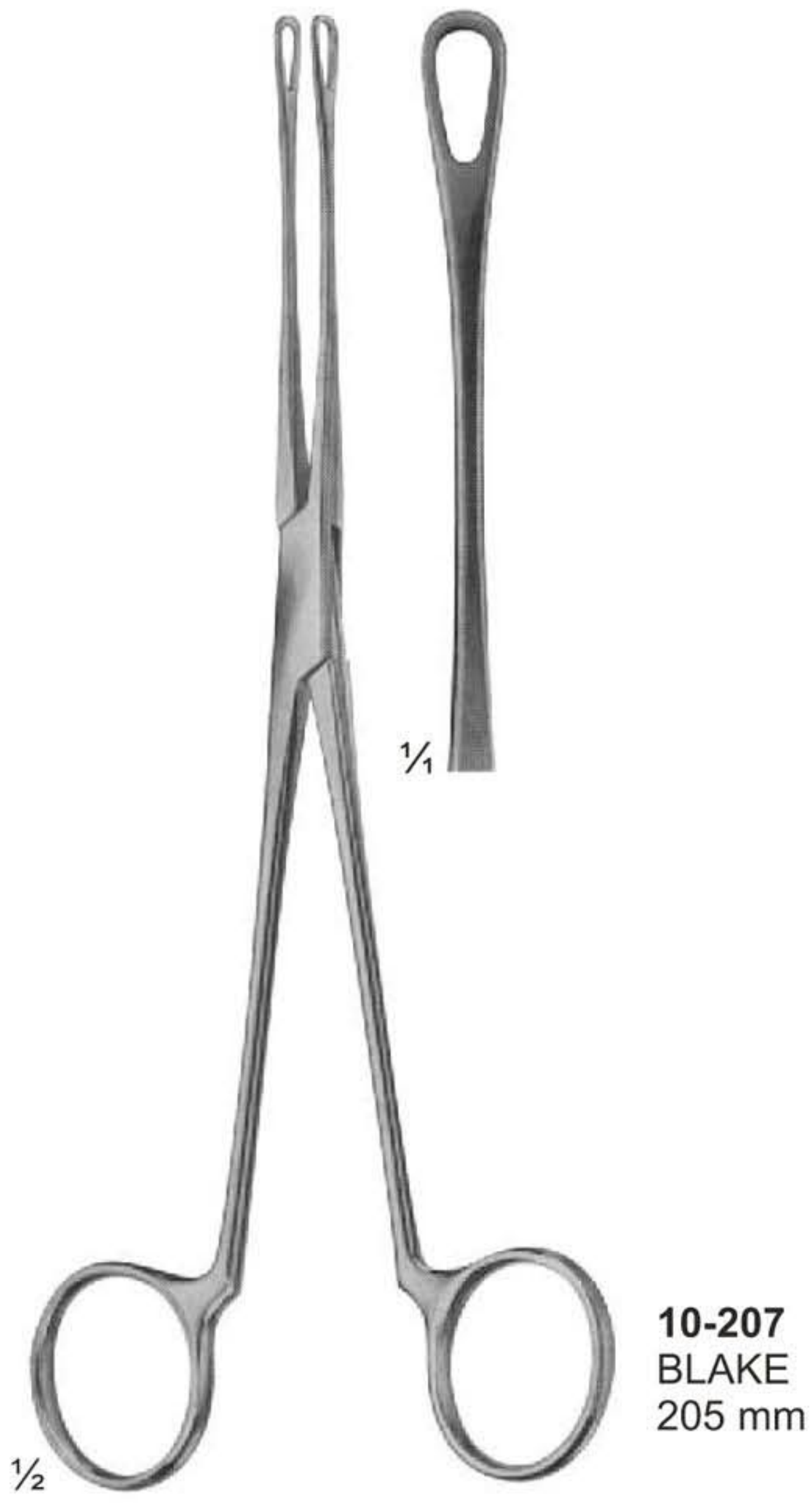



# Kidney Clamps





## Kidney Clamps

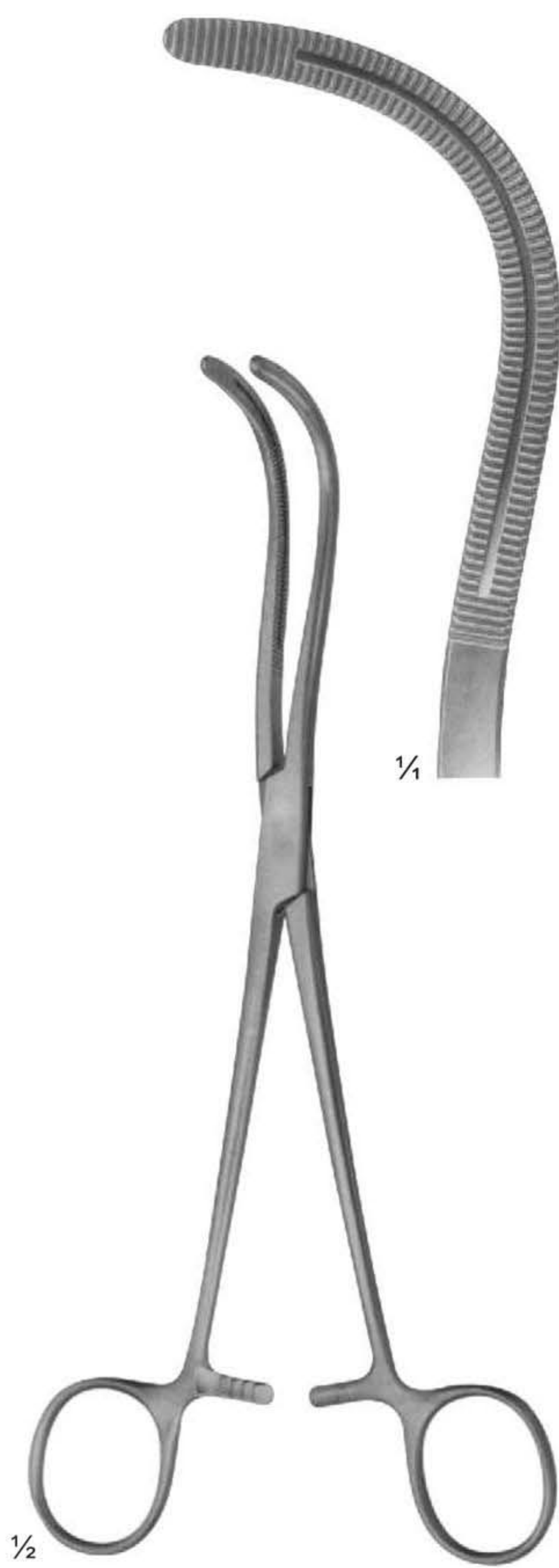

**10-222**  
STILLE  
220 mm

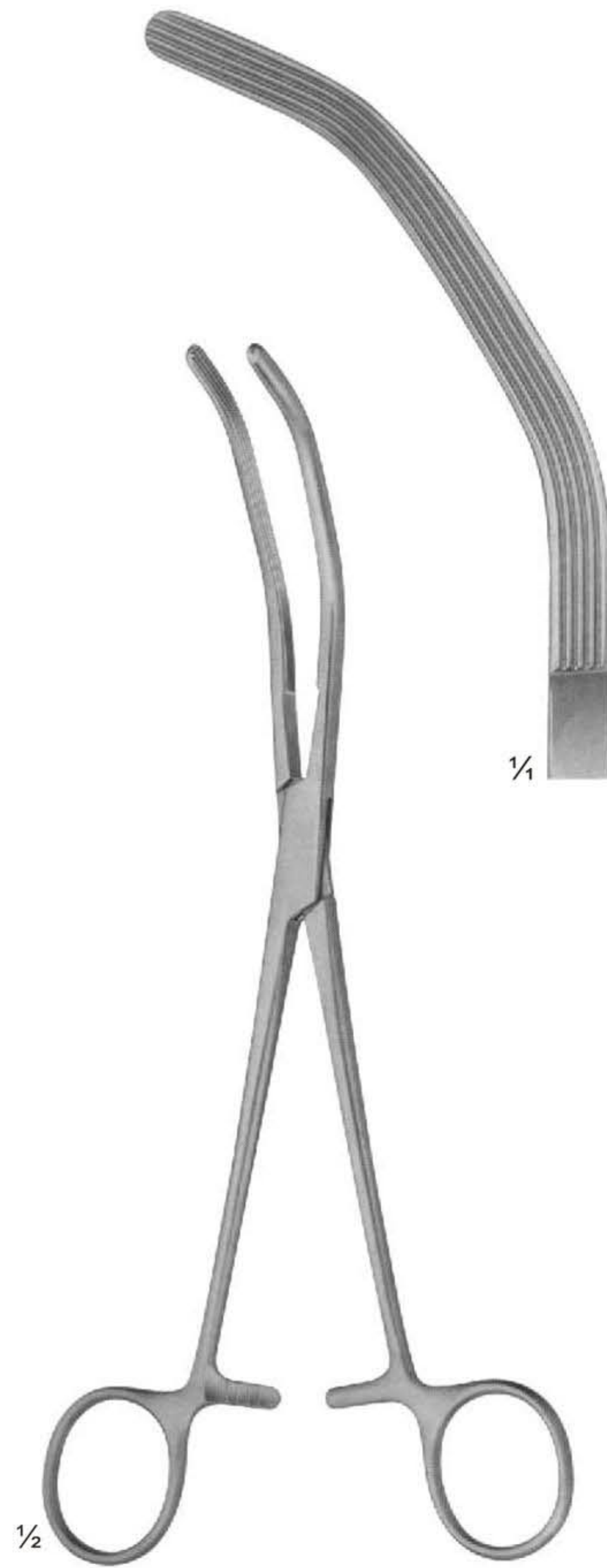

**10-223**  
HERRICK  
225 mm

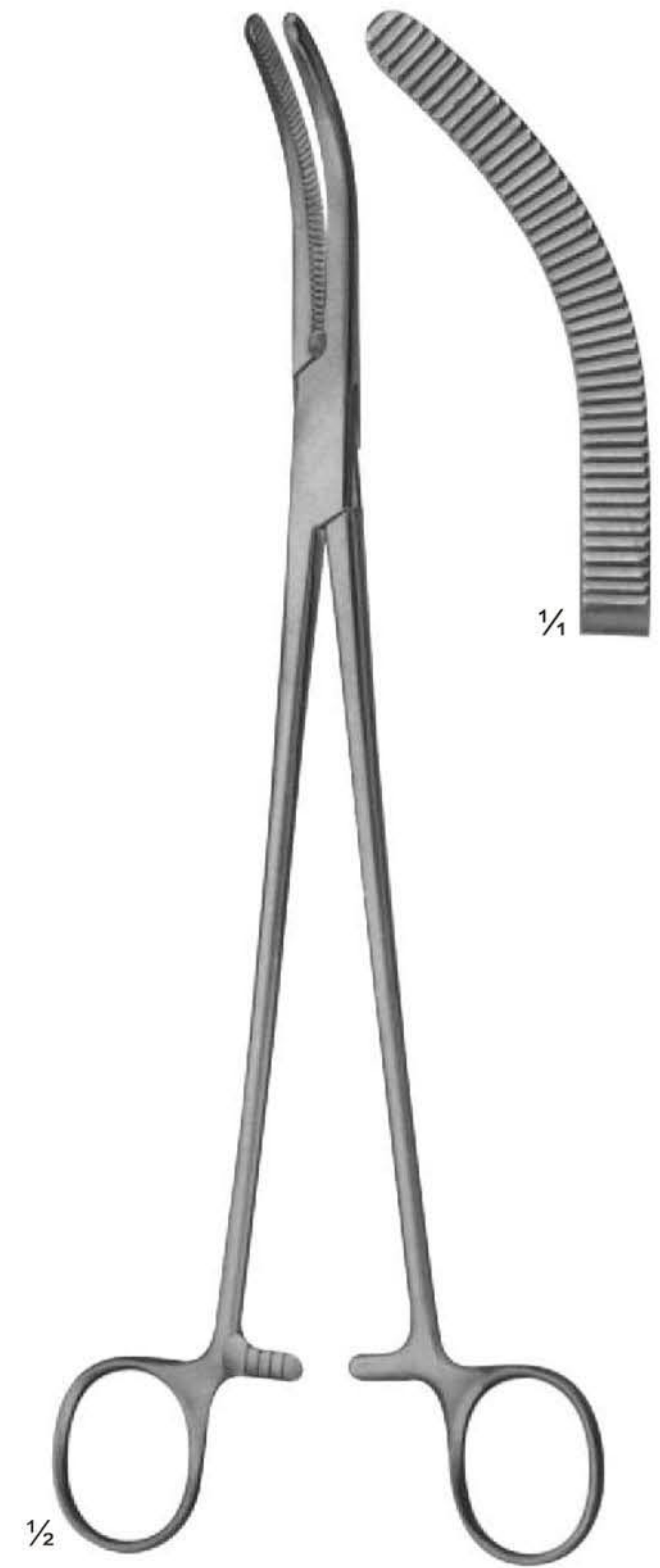

**10-224**  
WERTHEIM  
225 mm



## Kidney Elevating Forceps



1/2

**10-225**  
COLLIN  
285 mm

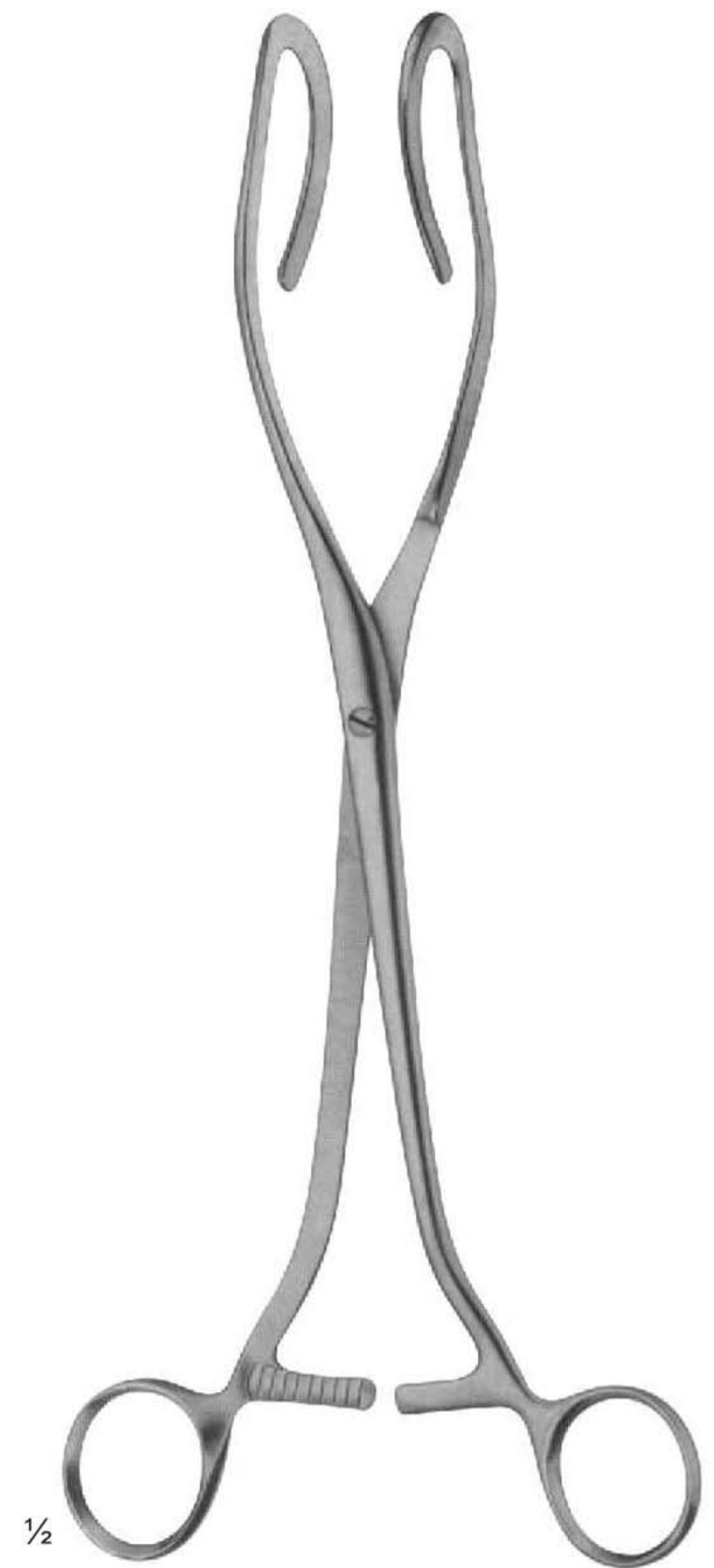

1/2

**10-226**  
DARTIGUES  
255 mm



**Kidney Stone Forceps**



10-227



10-228



10-229



$\frac{1}{4}$   
10-230



$\frac{1}{2}$

10-227 - 230  
RANDALL  
225 mm



10-231



10-232



$\frac{1}{4}$   
10-233



$\frac{1}{2}$

10-231 - 233  
RANDALL  
190 mm



**Bladder Retractors**

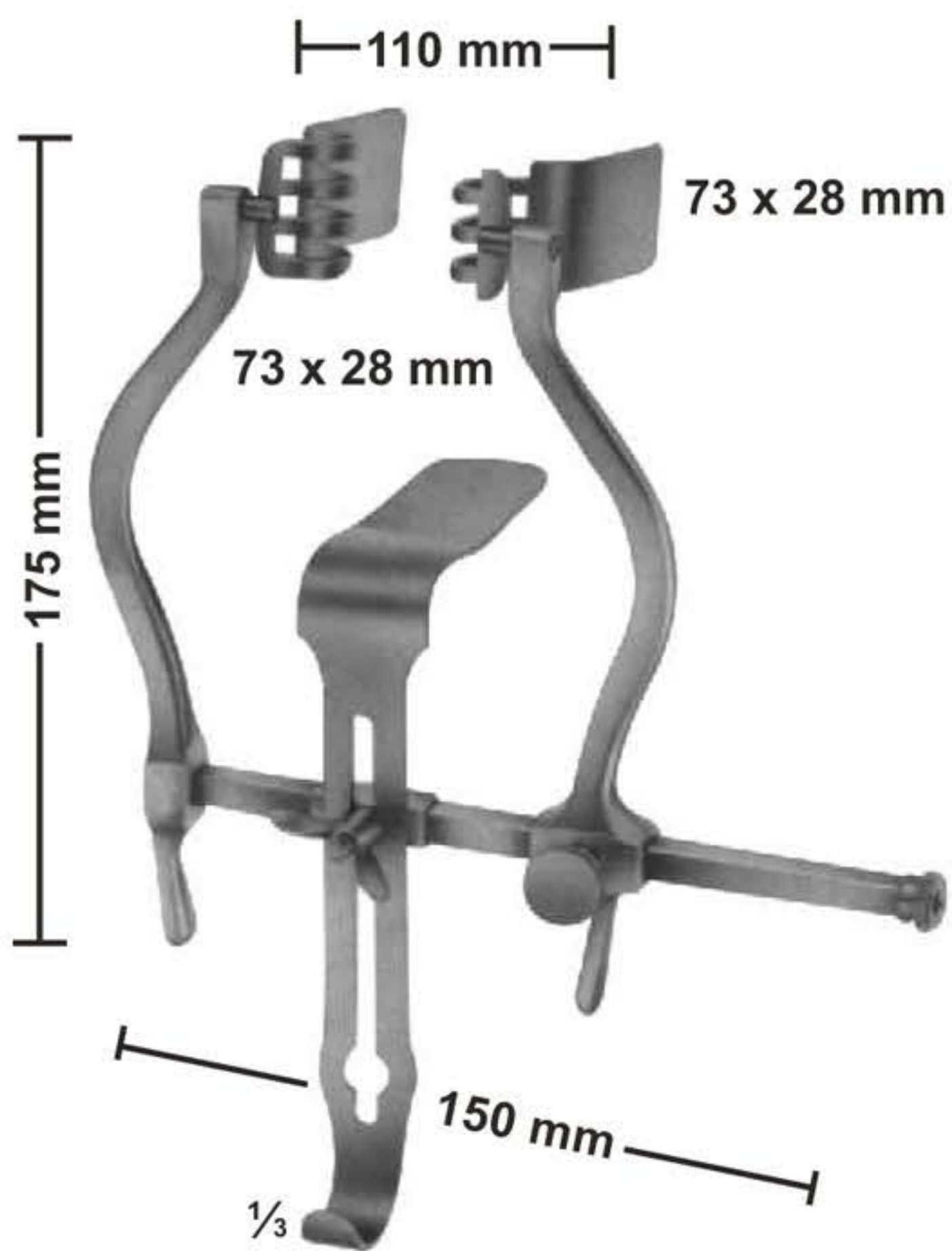

**11-101**  
JUDD-MASSON  
Bladder-and suprapubic  
retractor



**11-102**  
MILLIN  
Bladder retractor  
105X45 mm



**11-103**  
LEGUEU  
Bladder retractor  
Center blade  
80 x 31 mm

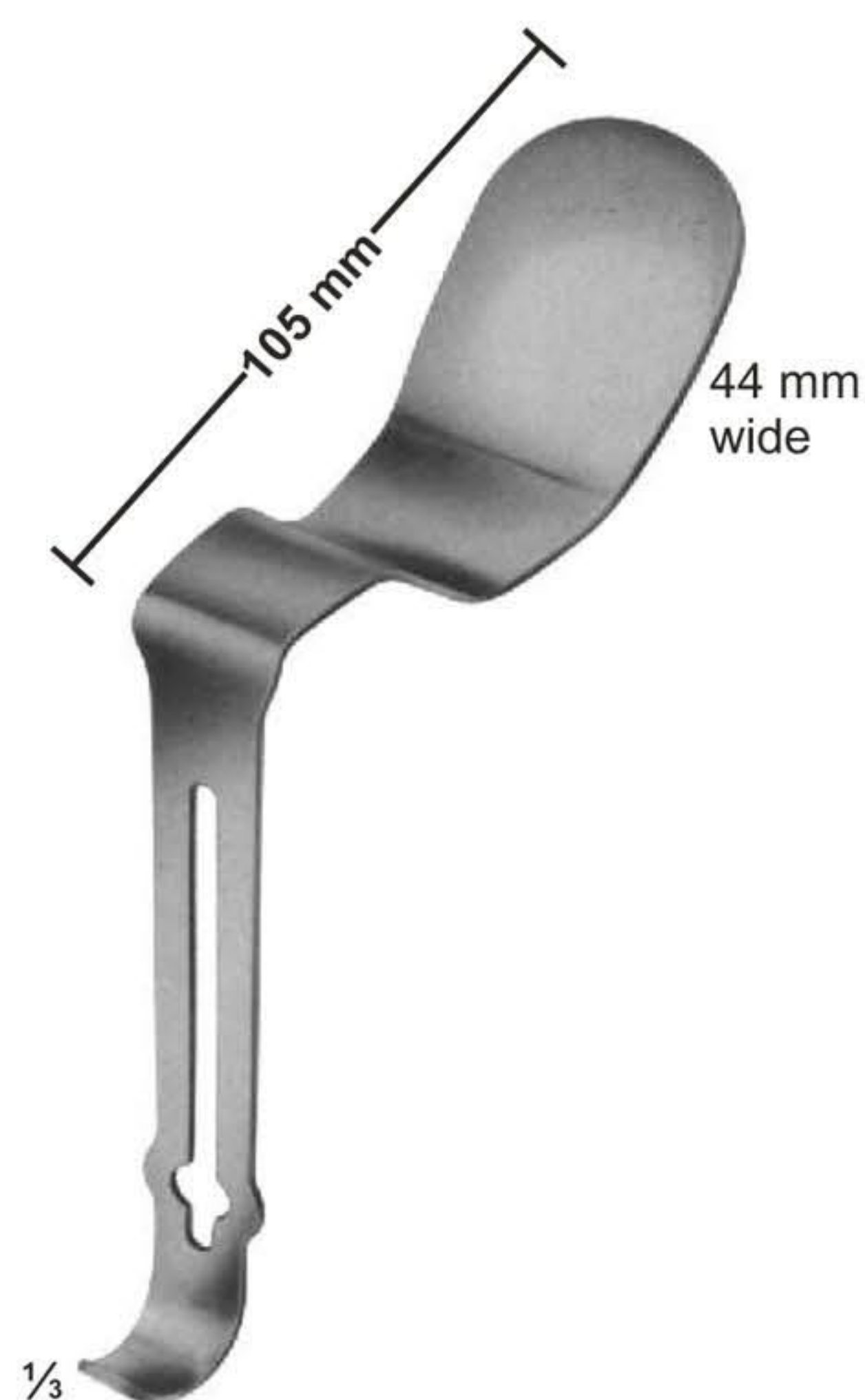

**11-104**  
MILLIN  
Center bladder for  
retro pubic prostatectomy

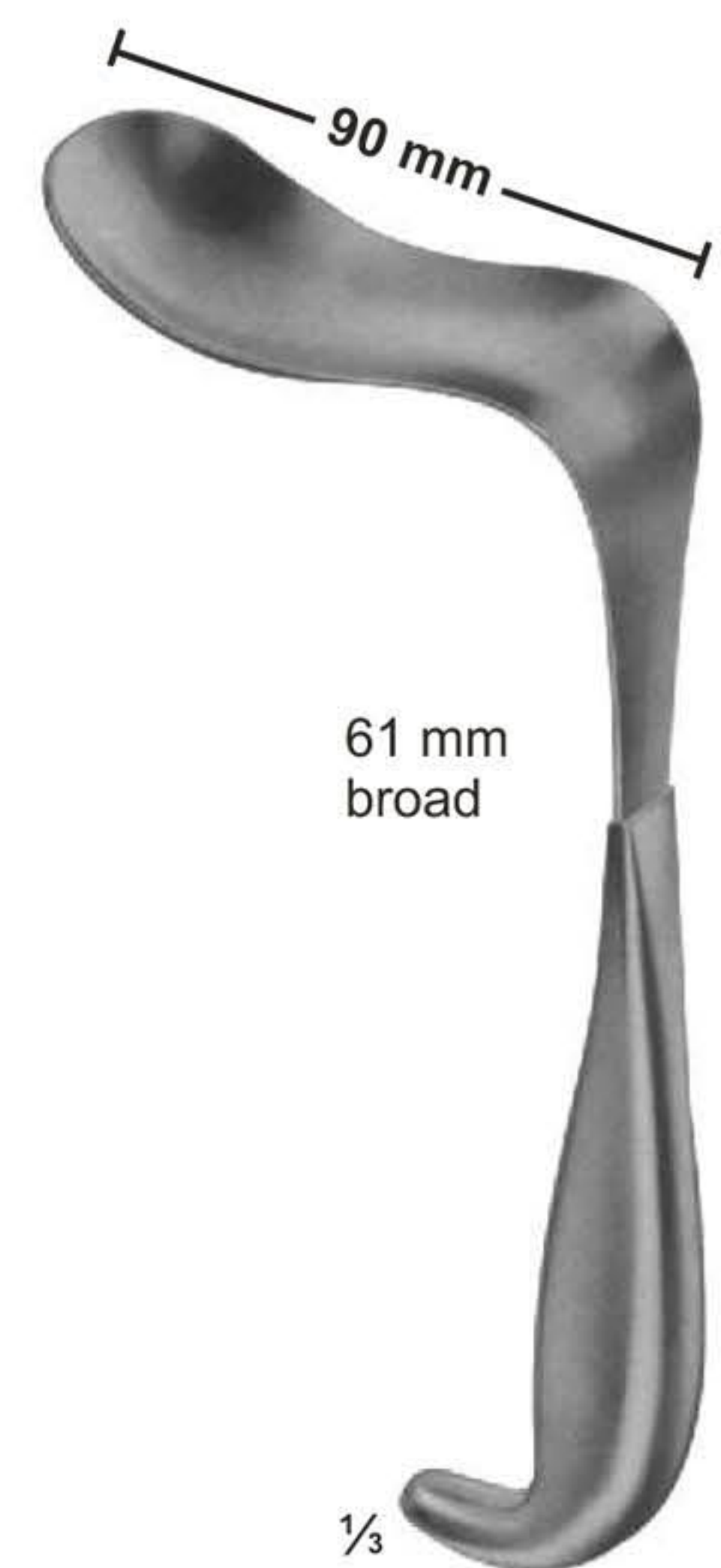

**11-105**  
KOCHER  
Bladder spatula  
235 mm



Genito-Urinary Instruments-Prostatectomy



**11-106**  
MATHIEU  
Foreign body forceps  
Length of shaft  
190 mm

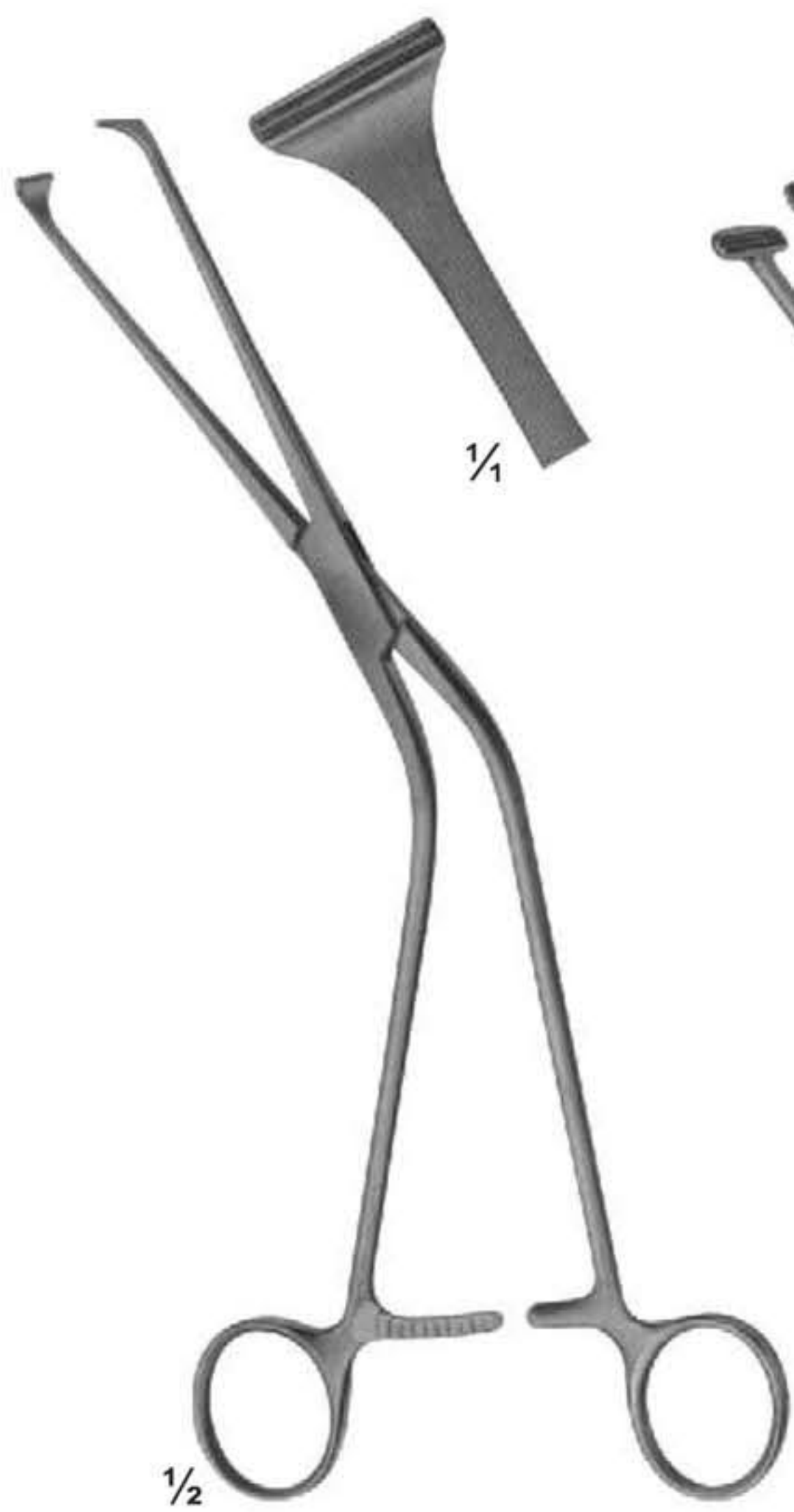

**11-107**  
MILLIN  
Lobe grasping  
forceps  
245 mm

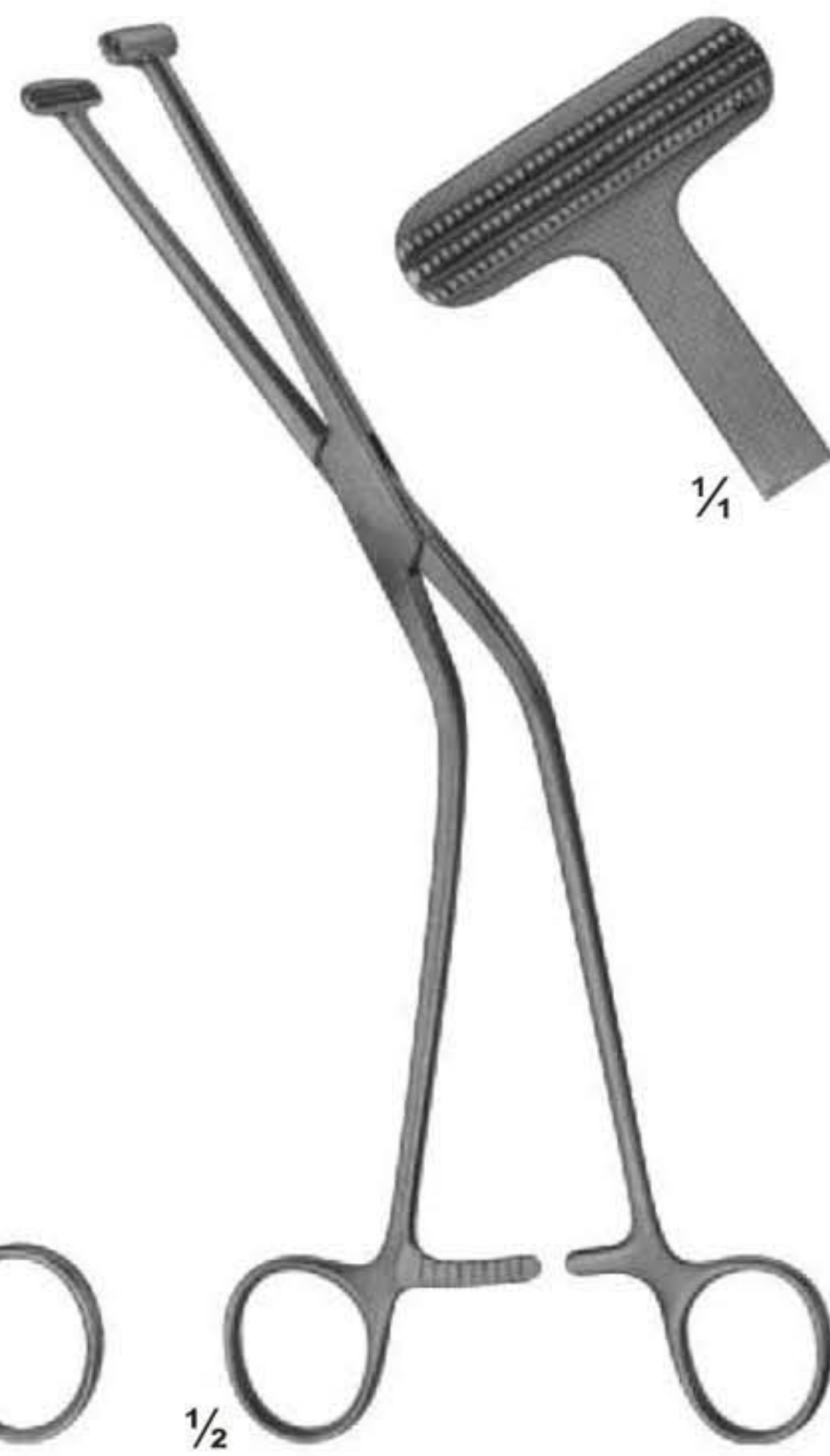

**11-108**  
MILLIN  
Lobe grasping  
forceps  
235 mm



**11-109**  
MILLIN  
Bladder neck spreader  
285 mm

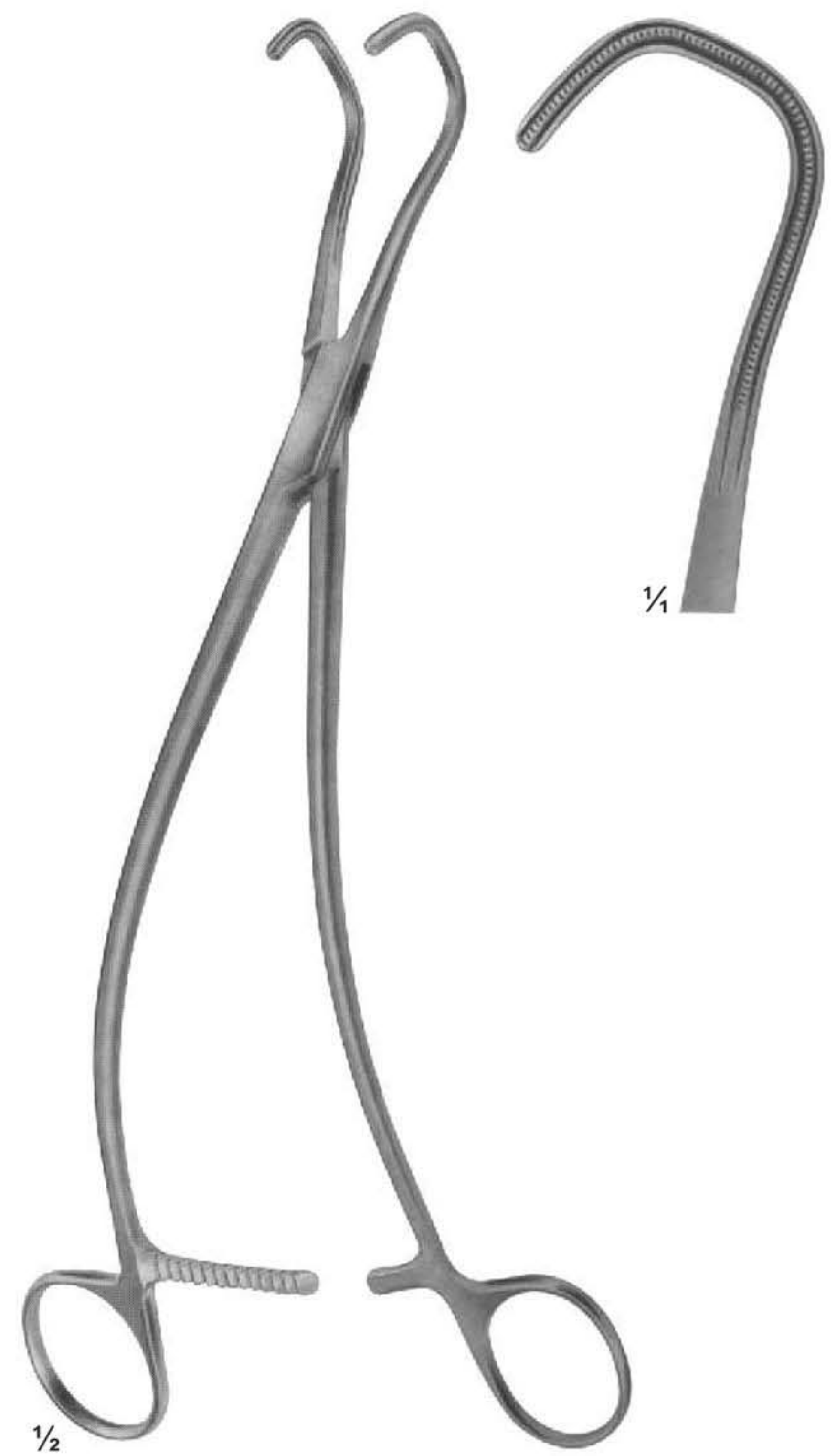

**11-110**  
Ureter forceps  
240 mm



**Genito-Urinary Instruments**



**11-111**  
GUYON  
Catheter guide  
(introducer)  
365 mm

- 11-112 6
- 11-113 7
- 11-114 8
- 11-115 9
- 11-116 10
- 11-117 11
- 11-118 12
- 11-119 13
- 11-120 14
- 11-121 15
- 11-122 16
- 11-123 18
- 11-124 20

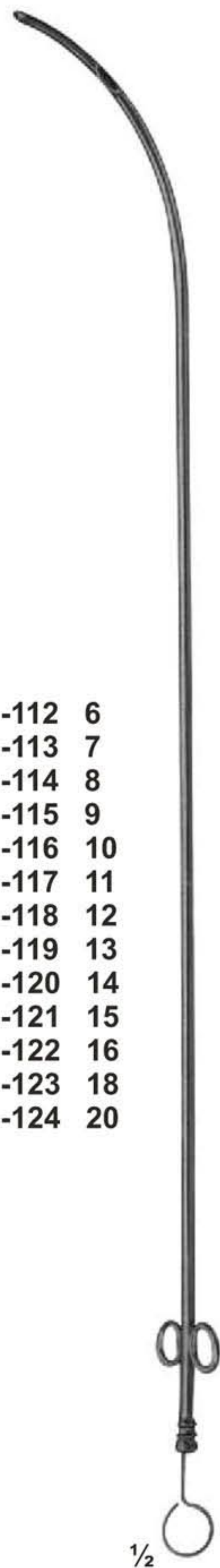

**11-112 - 124**  
Female catheters,  
metal  
160 mm

- 11-125 8
- 11-126 9
- 11-127 10
- 11-128 11
- 11-129 12
- 11-130 13
- 11-131 14
- 11-132 15
- 11-133 16
- 11-134 17
- 11-135 18
- 11-136 19
- 11-137 20
- 11-138 21
- 11-139 22
- 11-140 23
- 11-141 24
- 11-142 25
- 11-143 26
- 11-144 27
- 11-145 28
- 11-146 29
- 11-147 30



**11-125 - 147**  
Urethral bougies  
and dilating sounds  
345 mm

- 11-148 Ben. 24/Charr. 12
- 11-149 Ben. 25
- 11-150 Ben. 26/Charr. 13
- 11-151 Ben. 27
- 11-152 Ben. 28/Charr. 14
- 11-153 Ben. 29
- 11-154 Ben. 30/Charr. 15
- 11-155 Ben. 31
- 11-156 Ben. 32/Charr. 16
- 11-157 Ben. 33
- 11-158 Ben. 34/Charr. 17
- 11-159 Ben. 35
- 11-160 Ben. 36/Charr. 18
- 11-161 Ben. 37
- 11-162 Ben. 38/Charr. 19
- 11-163 Ben. 39
- 11-164 Ben. 40/Charr. 20
- 11-165 Ben. 41
- 11-166 Ben. 42/Charr. 21
- 11-167 Ben. 43
- 11-168 Ben. 44/Charr. 22
- 11-169 Ben. 45
- 11-170 Ben. 46/Charr. 23
- 11-171 Ben. 47
- 11-172 Ben. 48/Charr. 24
- 11-173 Ben. 49
- 11-174 Ben. 50/Charr. 25
- 11-175 Ben. 51
- 11-176 Ben. 52/Charr. 26
- 11-177 Ben. 53
- 11-178 Ben. 54/Charr. 27
- 11-179 Ben. 55
- 11-180 Ben. 56/Charr. 28
- 11-181 Ben. 57
- 11-182 Ben. 58/Charr. 29
- 11-183 Ben. 59
- 11-184 Ben. 60/Charr. 30



**11-148 - 184**  
Urethral bougies  
and dilating sounds  
255 mm



## Genito-Urinary Instruments & Circumcision Clamps



**11-185**  
GUYON  
Set of urethral bougies and dilating sounds,  
in metal case, with lift out rack and bottom  
rack, containing 21 urethral and dilating sounds.

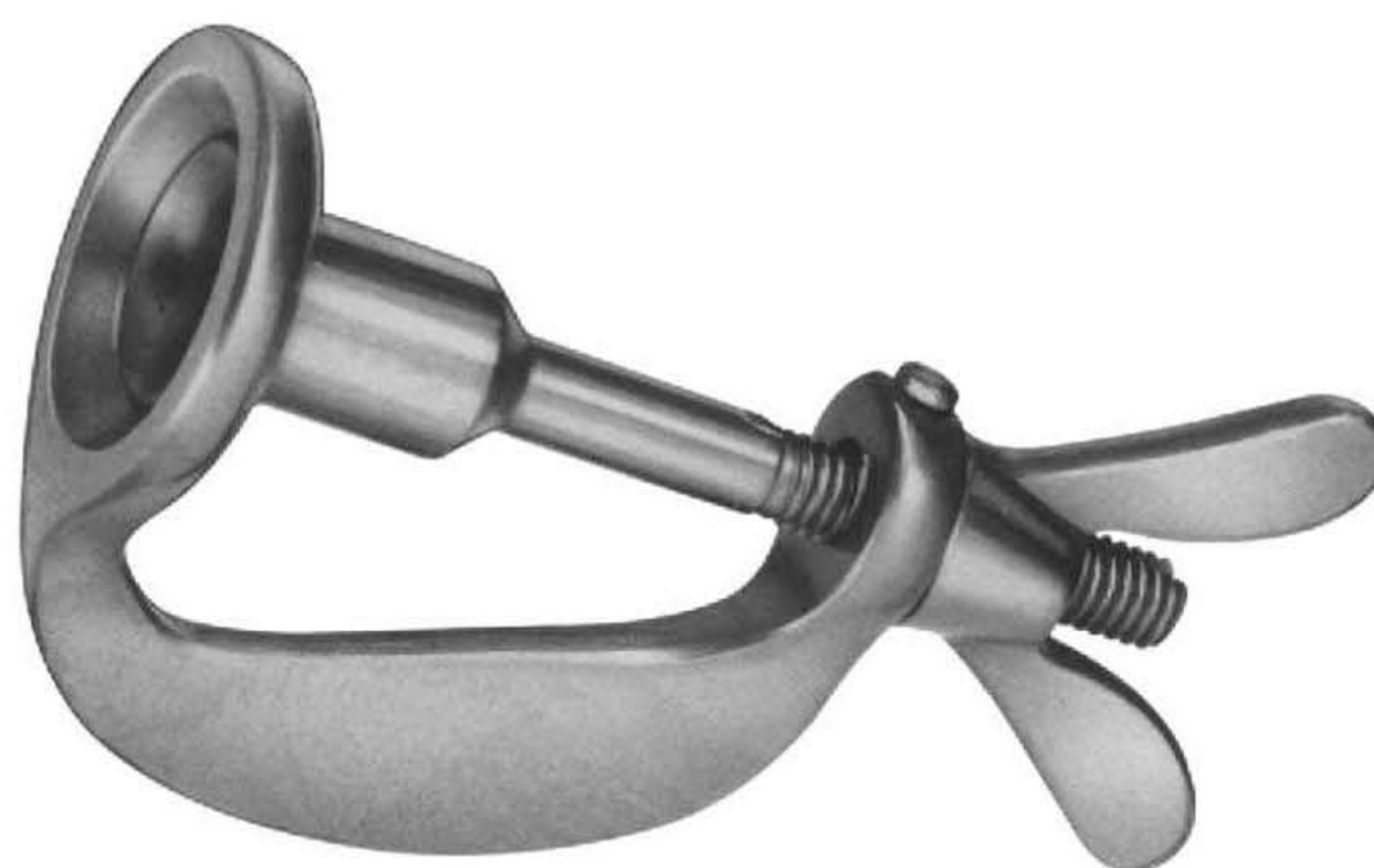

**11-186**  
WINKELMANN

### **Circumcision Clamps**

12 mm / 16 mm / 20 mm



**Trocars**

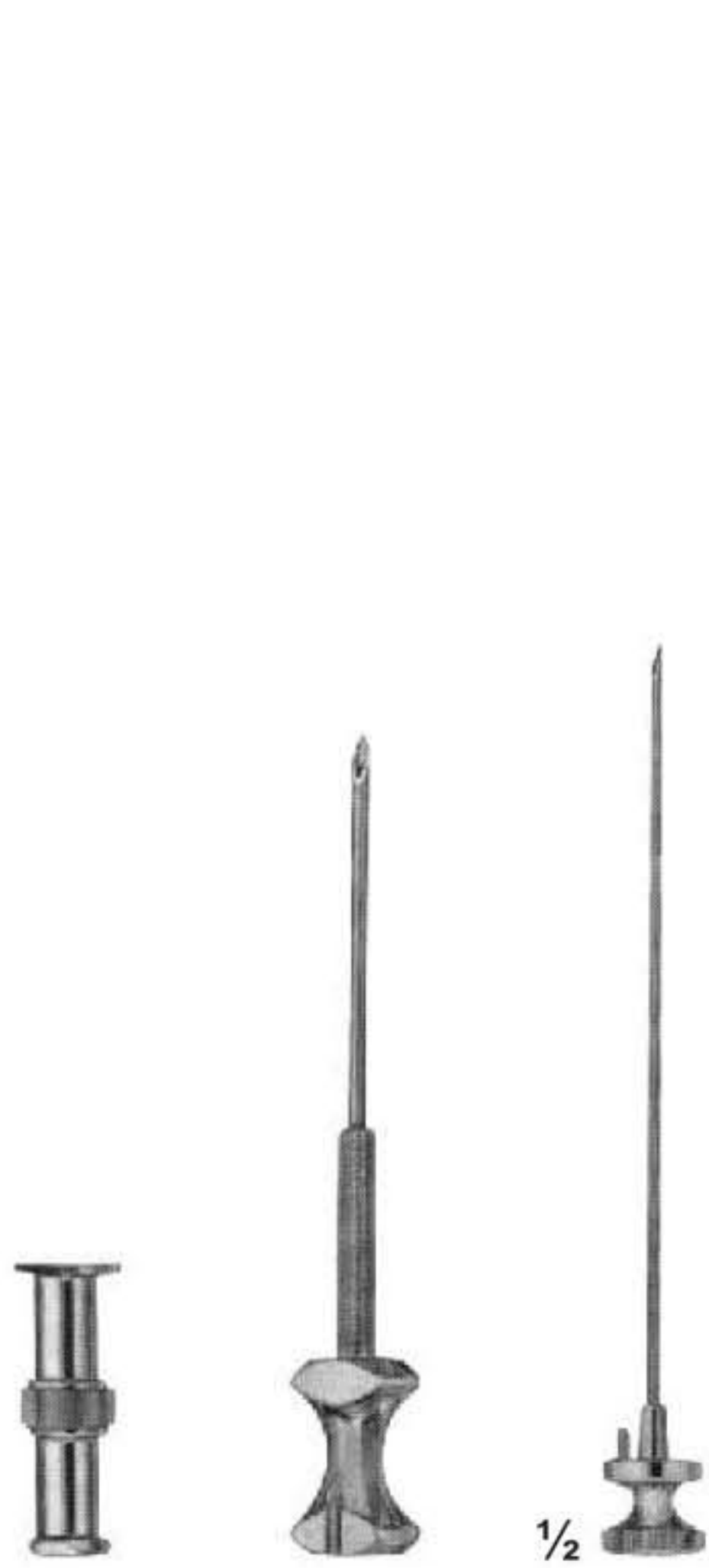

**11-187**  
KLIMA ROSEGGER  
35 X 1,8 mm  
Sternal puncture needle

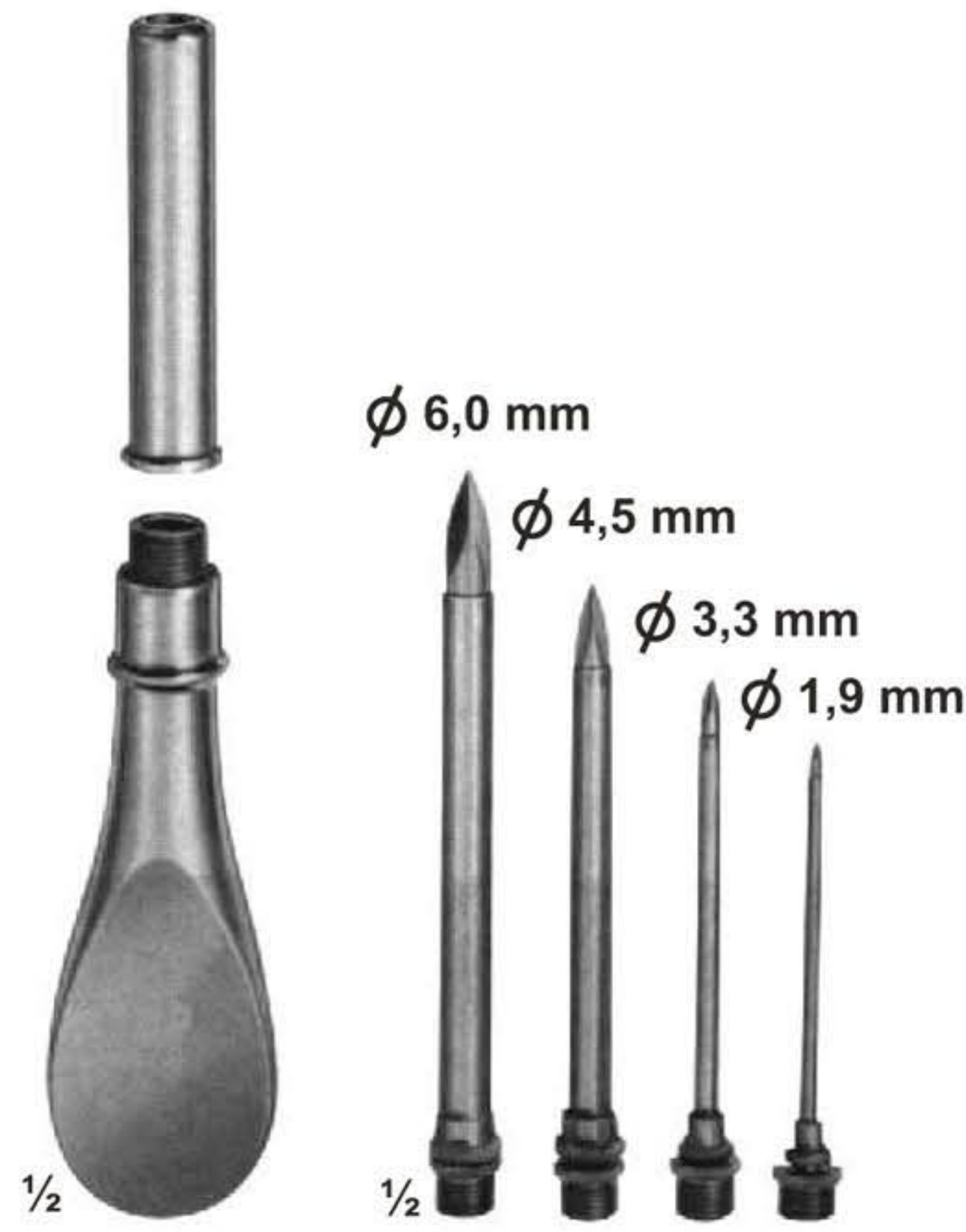

**11-188**  
Universal trocar  
with 4 tips



**11-189 - 193**  
Inside dime. Outside dime  
**11-189** 2,2 mm 3,0 mm  
**11-190** 3,0 mm 4,0 mm  
**11-191** 4,0 mm 5,0 mm  
**11-192** 5,0 mm 6,0 mm  
**11-193** 5,5 mm 6,5 mm  
for hydrocele and abdominal  
puncture



**11-194 - 197**  
Inside dime. Outside dime  
**11-194** 2,2 mm 3,0 mm  
**11-195** 3,0 mm 4,0 mm  
**11-196** 4,0 mm 5,0 mm  
**11-197** 5,0 mm 6,0 mm  
for abdominal puncture,  
with stop-cock and lateral  
drain

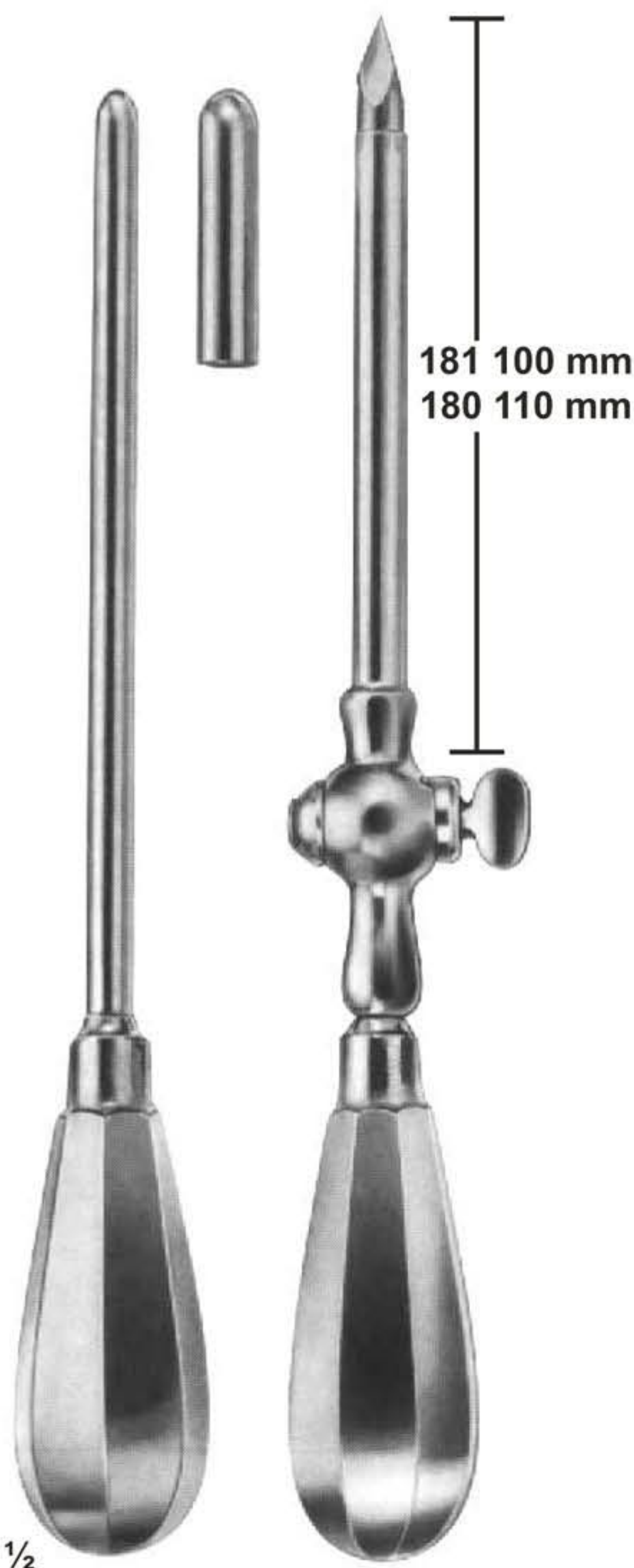

**11-198 - 199**  
Inside dime. Outside dime  
**11-198** 6,5 mm 8,0 mm  
**11-199** 9,0 mm 10,0 mm  
Empyema trocar

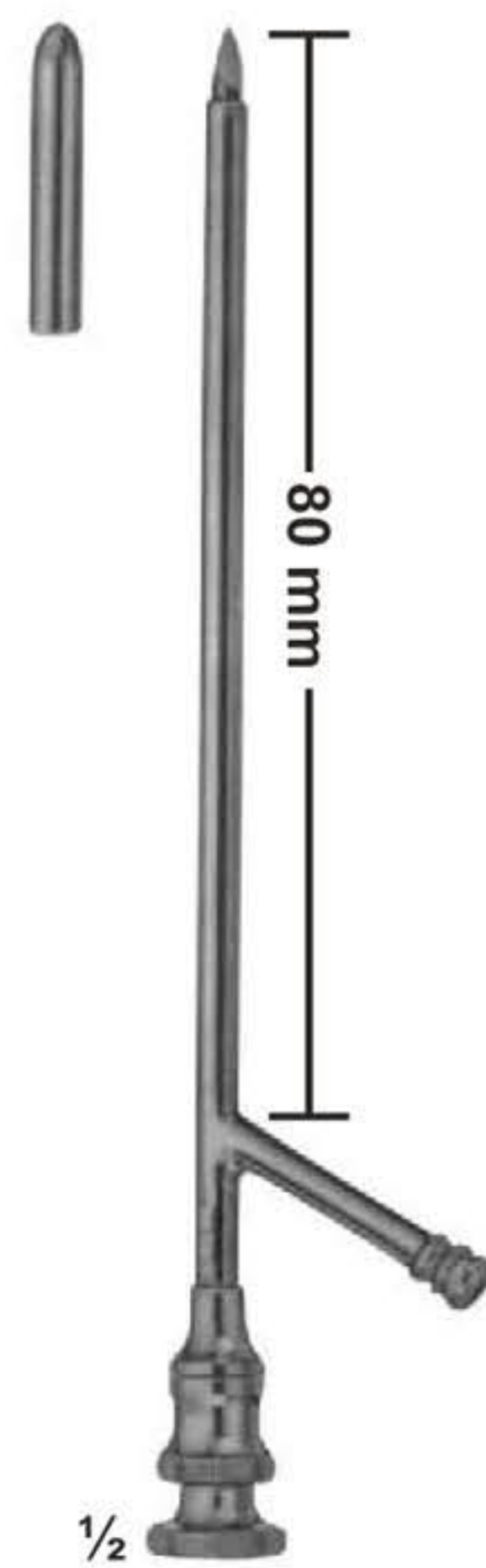

**11-200 - 203**  
Inside dime. Outside dime  
**11-200** 3,0 mm 4,0 mm  
**11-201** 3,6 mm 4,6 mm  
**11-202** 4,3 mm 5,3 mm  
**11-203** 5,0 mm 6,0 mm  
Gall bladder trocars



**11-204**  
PIERCE  
Antrum trocar  
4,0 mm



**11-205**  
COAKLEY  
Antrum trocar  
3,0 mm



## Vaginal specula

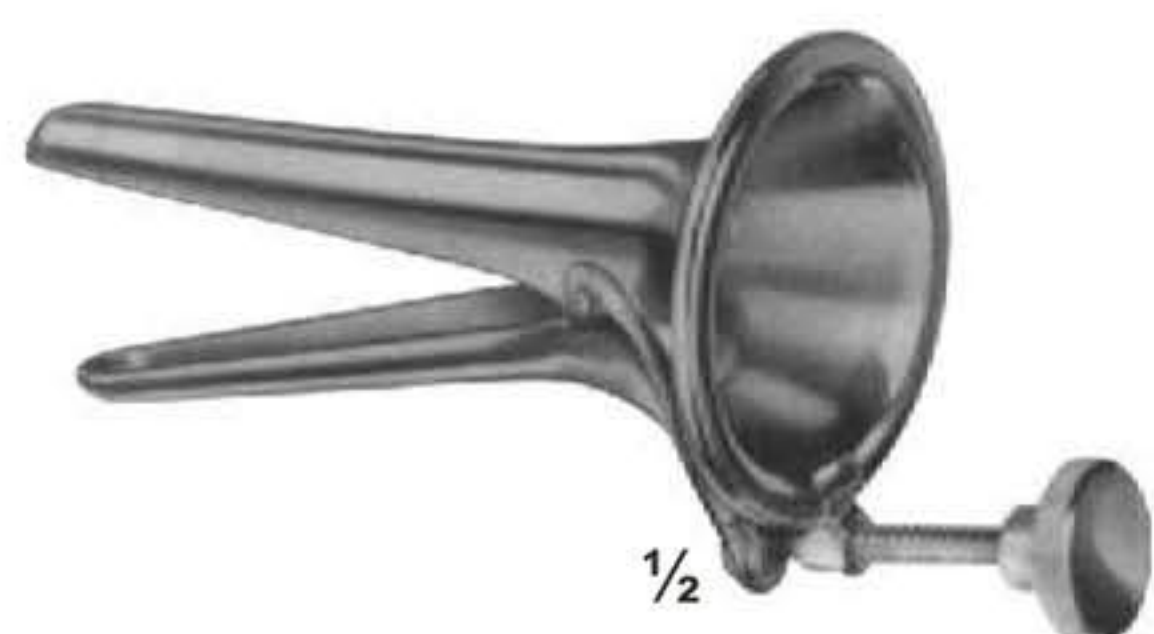

**12-101**  
COLLIN  
for children  
53 x 10 mm

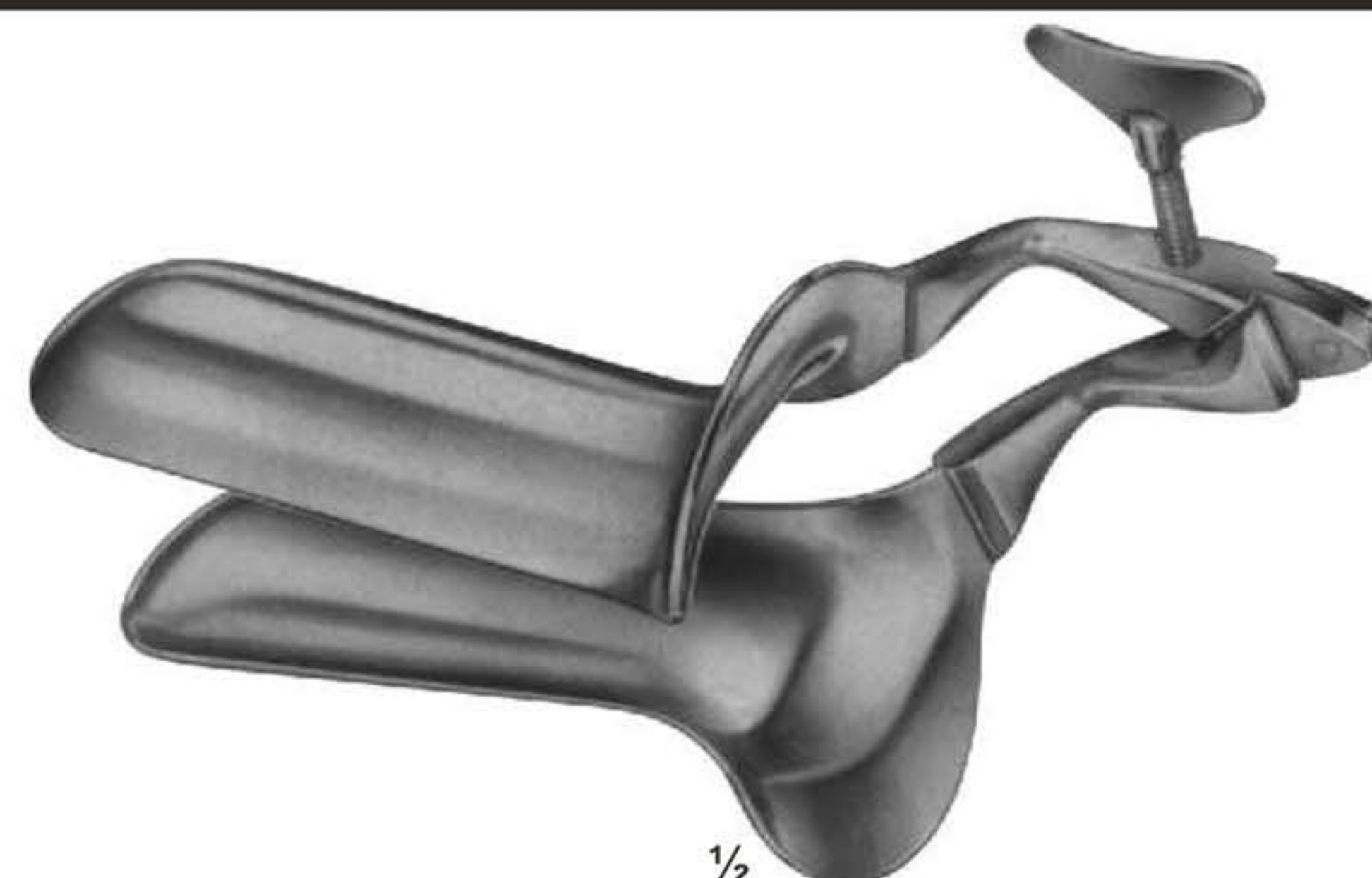

**12-102 - 105**  
COLLIN

<b>12-102</b>	100/90mm	28 mm
<b>12-103</b>	100/90mm	32 mm
<b>12-104</b>	105/95mm	35 mm
<b>12-105</b>	115/105mm	40 mm
Total length/working length		width



**12-106**  
COLLIN  
for virgins  
95/85 x 18 mm



**12-107**  
CUSCO  
for virgins  
75 x17 mm



**12-108**  
CUSCO  
for virgins  
75 x17 mm



**12-109 - 111**  
CUSCO

<b>12-109</b>	92X23-25 mm
<b>12-110</b>	100x25-27 mm
<b>12-111</b>	110x27-30 mm



## Vaginal Specula



1/2

**12-112 - 115**  
CUSCO  
STANDARD  
12-112 80X24 mm  
12-113 80X32 mm  
12-114 90X36 mm  
12-115 110X37 mm



1/2

**12-116 - 119**  
CUSCO  
12-116 80X24 mm  
12-117 80X32 mm  
12-118 90X36 mm  
12-119 110X37 mm



1/2

**12-120 - 122**  
CUSCO  
12-120 80X24 mm  
12-121 80X32 mm  
12-122 115X36 mm



1/2

**12-123 - 124**  
SEYFFERT  
12-123 100X24 mm  
12-124 110X32 mm  
230 mm



1/2

**12-125**  
SEMM  
for children  
and virgins  
180 mm



## Vaginal Specula, Sets, Upper & Lower Blades



**12-126 - 128**  
GRAVE  
12-126 75X20 mm  
12-127 95X30 mm  
12-128 105X33 mm

1/2

**12-129 - 130**  
PEDERSON  
12-129 100X22 mm  
12-130 120X25 mm

1/2

**12-131 - 132**  
BRIESKY  
12-131 72X25 mm / 77X30 mm  
12-132 75X30 mm / 92X38 mm  
170 mm

1/2



1/2

**12-133 - 134**  
BREISKY  
12-133 100X22 mm  
77 X30 mm  
140 mm  
12-134 120X25 mm  
92 X38 mm  
170 mm



1/2

**12-135 - 137**  
SEIDL  
12-135 80X8 mm  
12-136 80X10 mm  
12-137 90X14 mm  
For children and infants  
170 mm



1/2

**12-138**  
KRISTELLER  
70X15 mm, ( 170 mm )  
For children



1/2

**12-139 - 141**  
SIMS  
12-139 70X26 mm  
75 X30 mm 125 mm  
12-140 75X30 mm  
80 X85 mm 150 mm  
11-141 80X36 mm  
90 X40 mm 175 mm



# Vaginal Specula-Sets, upper and lower blades

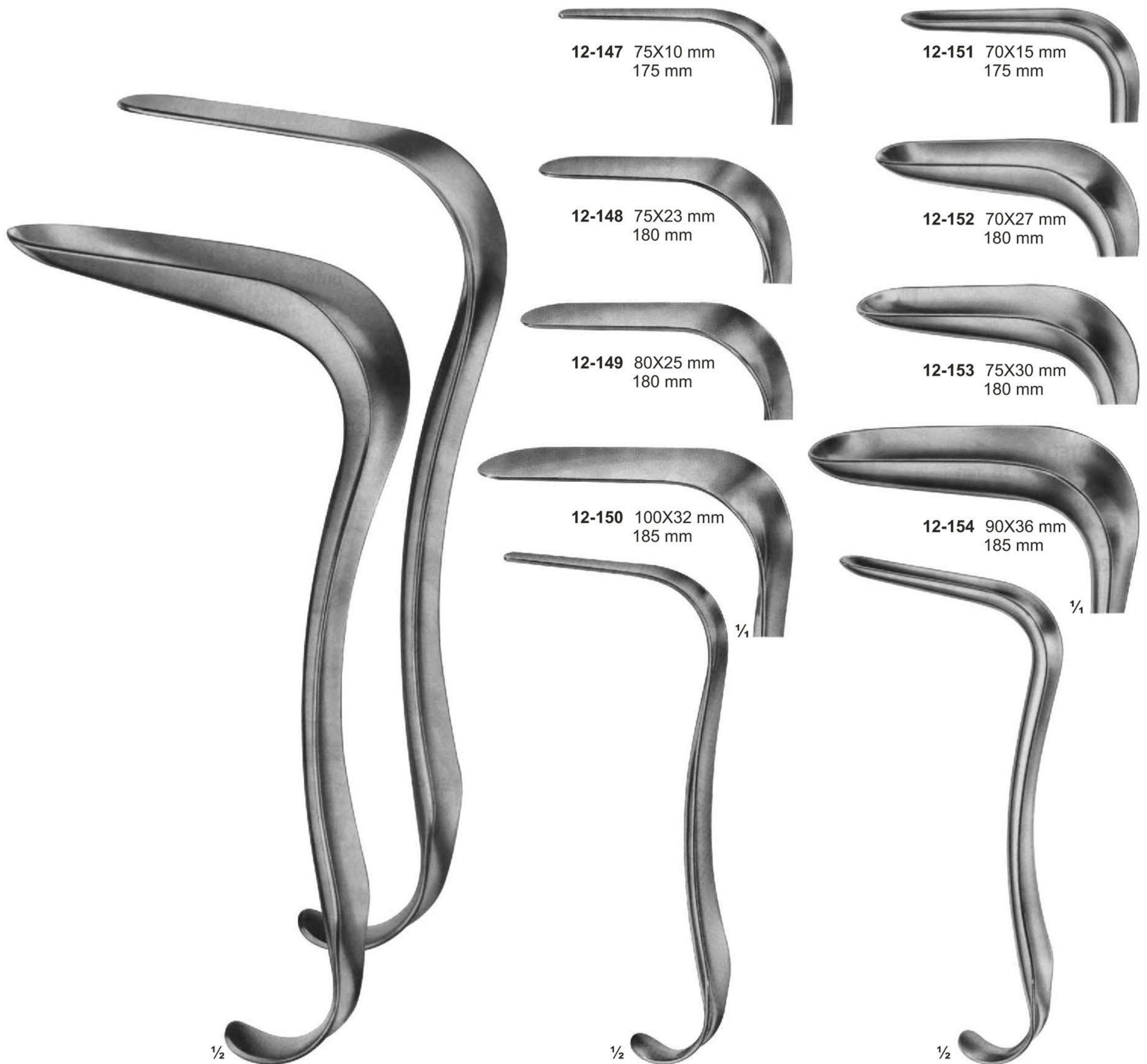



# Vaginal Specula-upper and lower blades

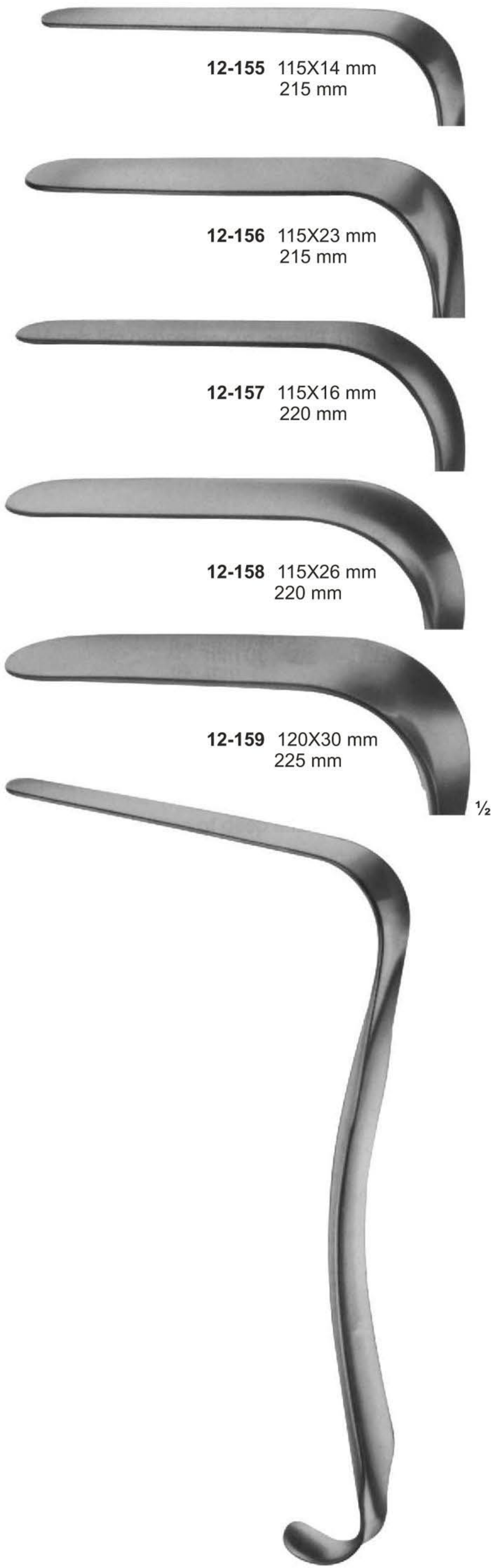

**12-155 - 159**  
KRISTELLER  
Upper blades

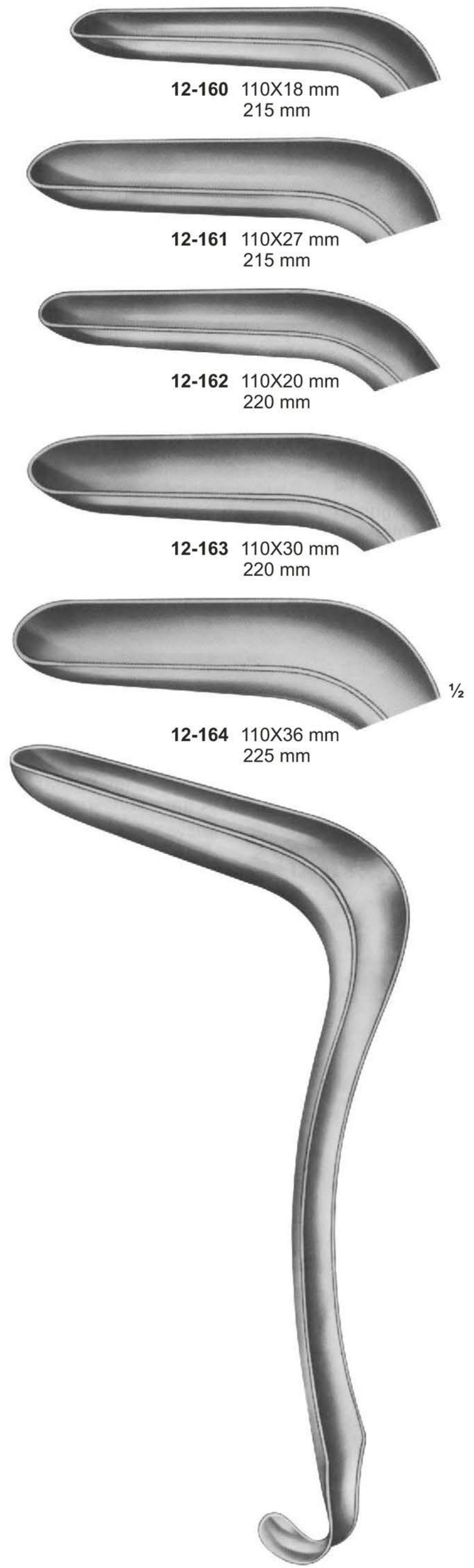

**12-160 - 164**  
KRISTELLER  
Lower blades





# Vaginal Specula

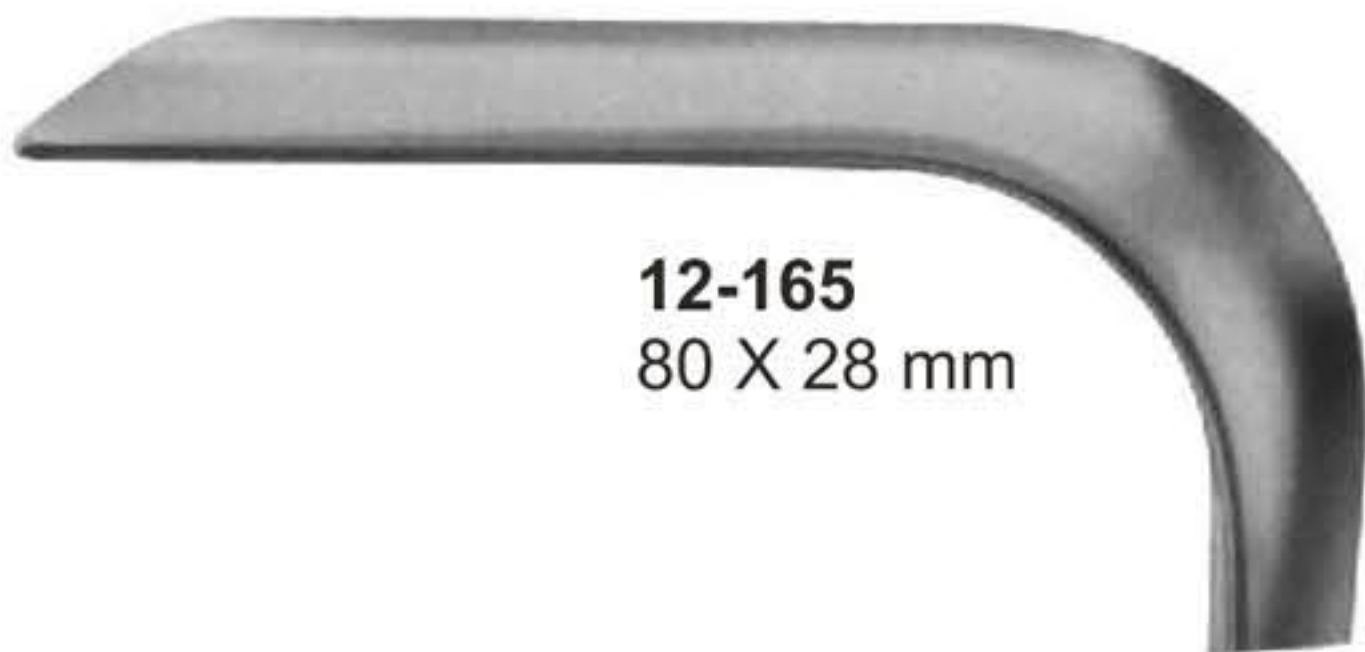

**12-165**  
80 X 28 mm



**12-168**  
76 X 38 mm



**12-166**  
85 X 35 mm



**12-169**  
89 X 38 mm

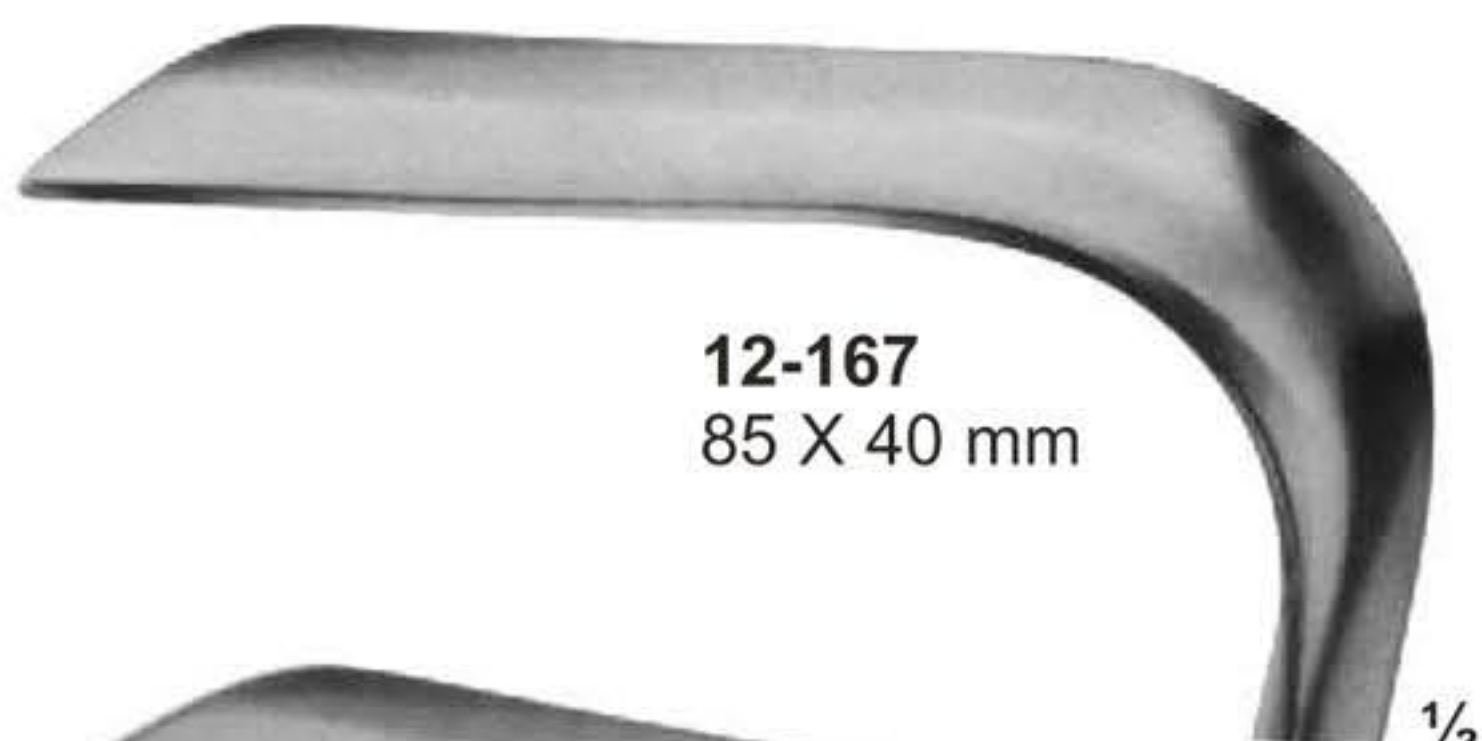

**12-167**  
85 X 40 mm

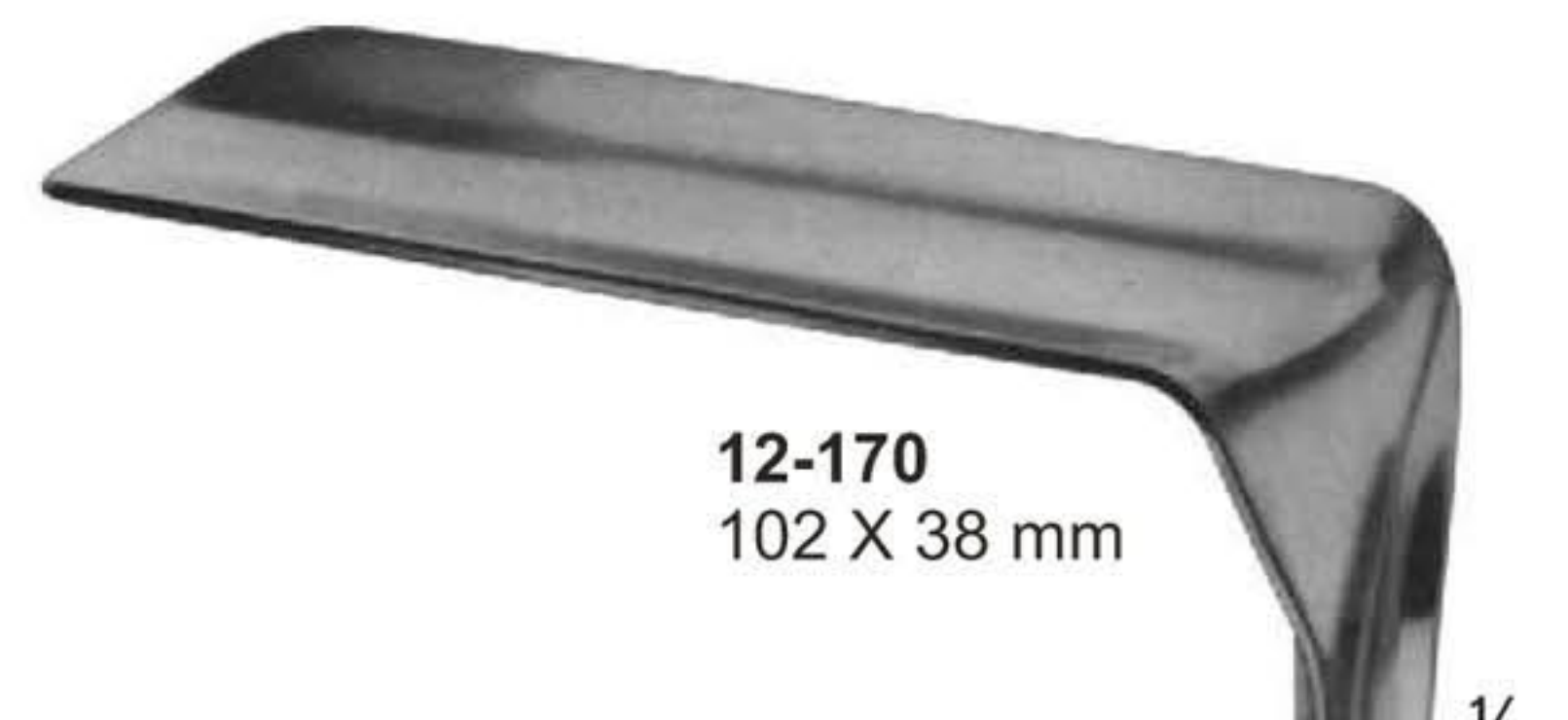

**12-170**  
102 X 38 mm



Slightly Concave

1/2

**12-165 - 167**  
KRISTELLER  
205 mm



Slightly Concave

1/2

**12-168 - 170**  
JACKSON  
175 mm



Vaginal Specula-for children & virgins / Vario Retractor





## Vaginal Specula-for children and virgins

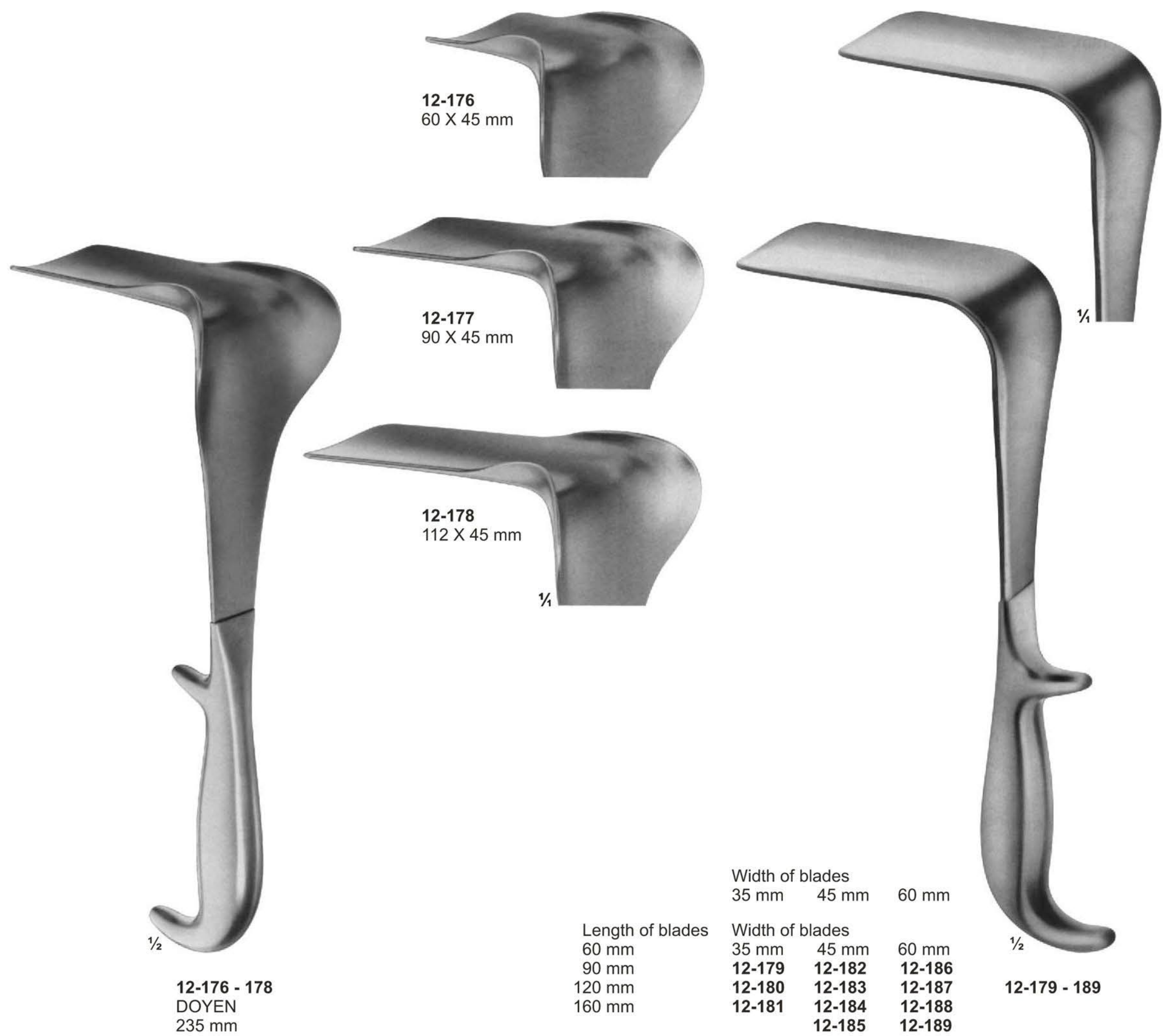



## Vaginal Specula / Retractors



1/2

**12-190 - 194**  
BREISKY  
WIENER MODELL/  
VIENNA PATTERN  
**12-190** 100 X 20 mm  
**12-191** 100 X 25 mm  
**12-192** 100 X 30 mm  
**12-193** 100 X 35 mm  
**12-194** 100 X 40 mm  
300 mm



1/2

**12-195 - 199**  
BREISKY  
WIENER MODELL/  
VIENNA PATTERN  
**12-195** 130 X 20 mm  
**12-196** 130 X 25 mm  
**12-197** 130 X 30 mm  
**12-198** 130 X 35 mm  
**12-199** 130 X 40 mm  
320 mm



1/2

**12-200 - 201**  
WEISSBARTH  
**12-200** 80 X 28 mm  
**12-201** 85 X 42 mm  
210 mm



1/2

**12-202**  
DOYEN  
lateral speculum  
80 x 30 mm  
250 mm



Vaginal & Wound Retractor / Vaginal Specula



**12-203**  
SIMON  
115 X 22 mm  
275 mm



**12-204**  
AUVARD  
65 X 38 mm - 28 mm  
1,530 kg  
with fixed weight  
230 mm



**12-205 - 206**  
AUVARD  
**12-205** 75 X 42 mm  
( 40 mm )  
**12-206** 105 X 43 mm  
( 40 mm )  
with detachable wight  
230 mm



**12-207**  
MARTIN  
with hook shaped  
handle for hanging  
in weights  
270 mm



# Vaginal Speculas

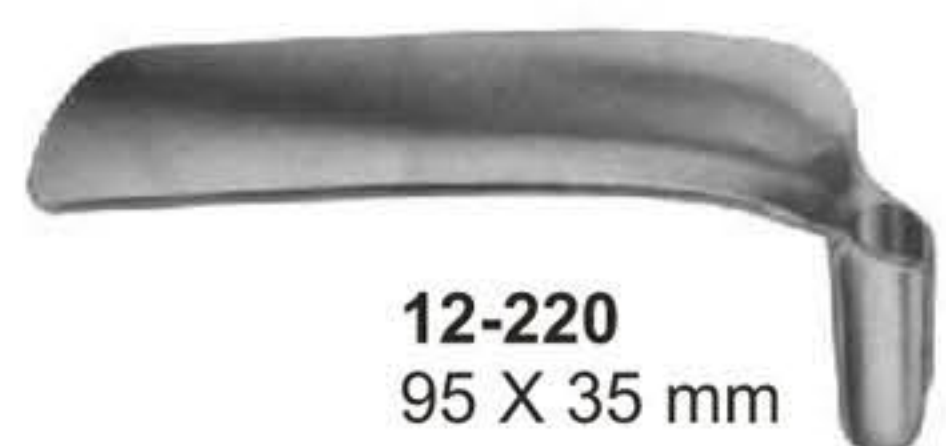
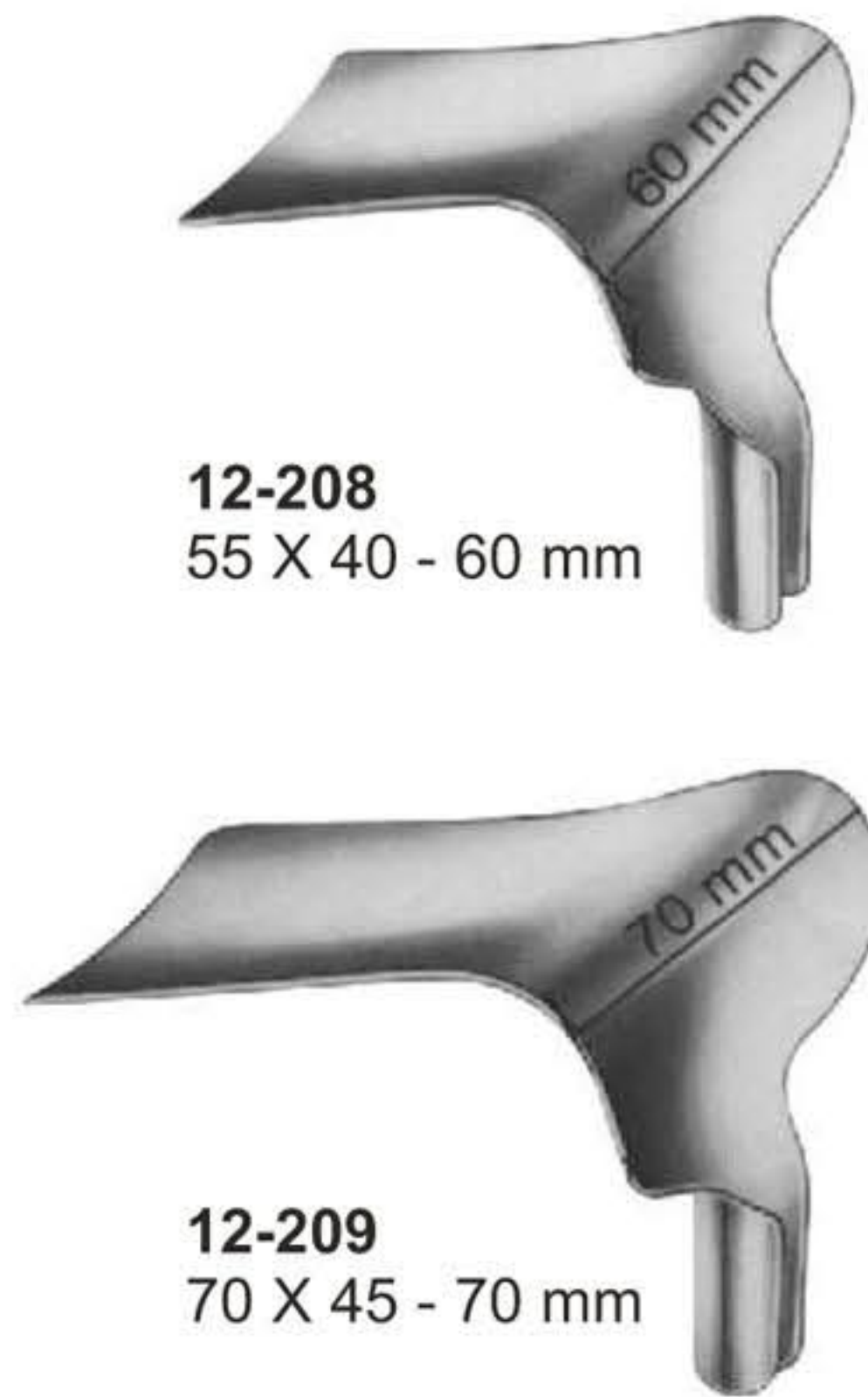

12-213 - 220  
SCHERBACK  
Set consisting of:  
2 handle  
8 blades

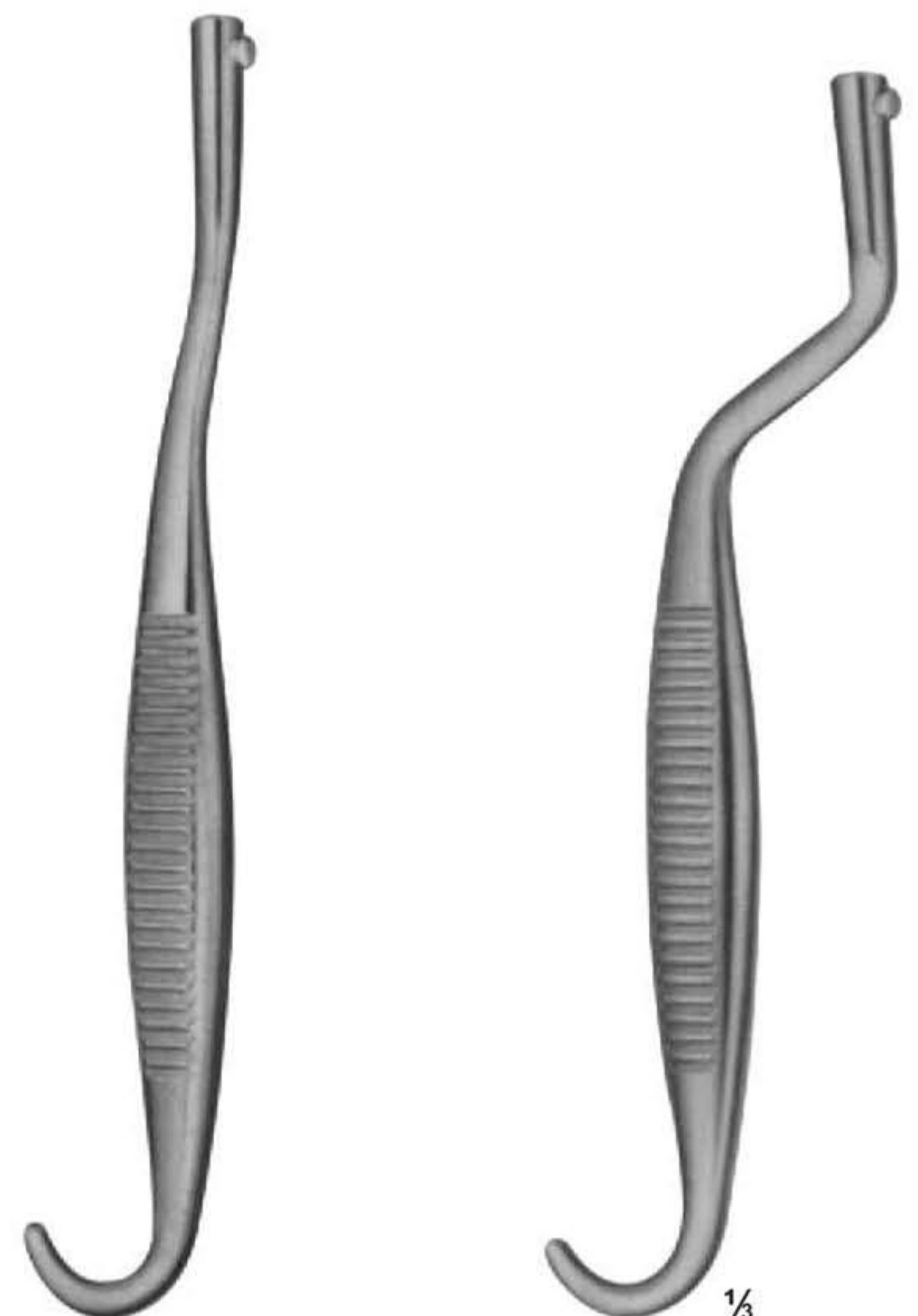



Vaginal Retractors



1/2  
**12-221**  
JOLL (FRIEDMAN)  
155 mm



1/2  
**12-222**  
RICHTER  
170 mm



1/2  
**12-223**  
GELPI  
135 mm



1/2  
**12-224**  
GELPI  
175 mm



# Uterine Dilators



1/2

**13-101 - 143**  
 HEGAR  
 with very conical point  
 185 mm

<b>13-101</b>	1	mm	<b>13-123</b>	23	mm
<b>13-102</b>	2	mm	<b>13-124</b>	24	mm
<b>13-103</b>	3	mm	<b>13-125</b>	25	mm
<b>13-104</b>	4	mm	<b>13-126</b>	26	mm
<b>13-105</b>	5	mm	<b>13-127</b>	1	1/2mm
<b>13-106</b>	6	mm	<b>13-128</b>	2	1/2mm
<b>13-107</b>	7	mm	<b>13-129</b>	3	1/2mm
<b>13-108</b>	8	mm	<b>13-130</b>	4	1/2mm
<b>13-109</b>	9	mm	<b>13-131</b>	5	1/2mm
<b>13-110</b>	10	mm	<b>13-132</b>	6	1/2mm
<b>13-111</b>	11	mm	<b>13-133</b>	7	1/2mm
<b>13-112</b>	12	mm	<b>13-134</b>	8	1/2mm
<b>13-113</b>	13	mm	<b>13-135</b>	9	1/2mm
<b>13-114</b>	14	mm	<b>13-136</b>	10	1/2mm
<b>13-115</b>	15	mm	<b>13-137</b>	11	1/2mm
<b>13-116</b>	16	mm	<b>13-138</b>	12	1/2mm
<b>13-117</b>	17	mm	<b>13-139</b>	13	1/2mm
<b>13-118</b>	18	mm	<b>13-140</b>	14	1/2mm
<b>13-119</b>	19	mm	<b>13-141</b>	15	1/2mm
<b>13-120</b>	20	mm	<b>13-142</b>	16	1/2mm
<b>13-121</b>	21	mm	<b>13-143</b>	17	1/2mm
<b>13-122</b>	22	mm			



1/2

**13-144 - 152**  
 HEGAR  
 205 mm

<b>13-144</b>	1+2	mm
<b>13-145</b>	3+4	mm
<b>13-146</b>	5+6	mm
<b>13-147</b>	7+8	mm
<b>13-148</b>	9+10	mm
<b>13-149</b>	11+12	mm
<b>13-150</b>	13+14	mm
<b>13-151</b>	15+16	mm
<b>13-152</b>	17+18	mm

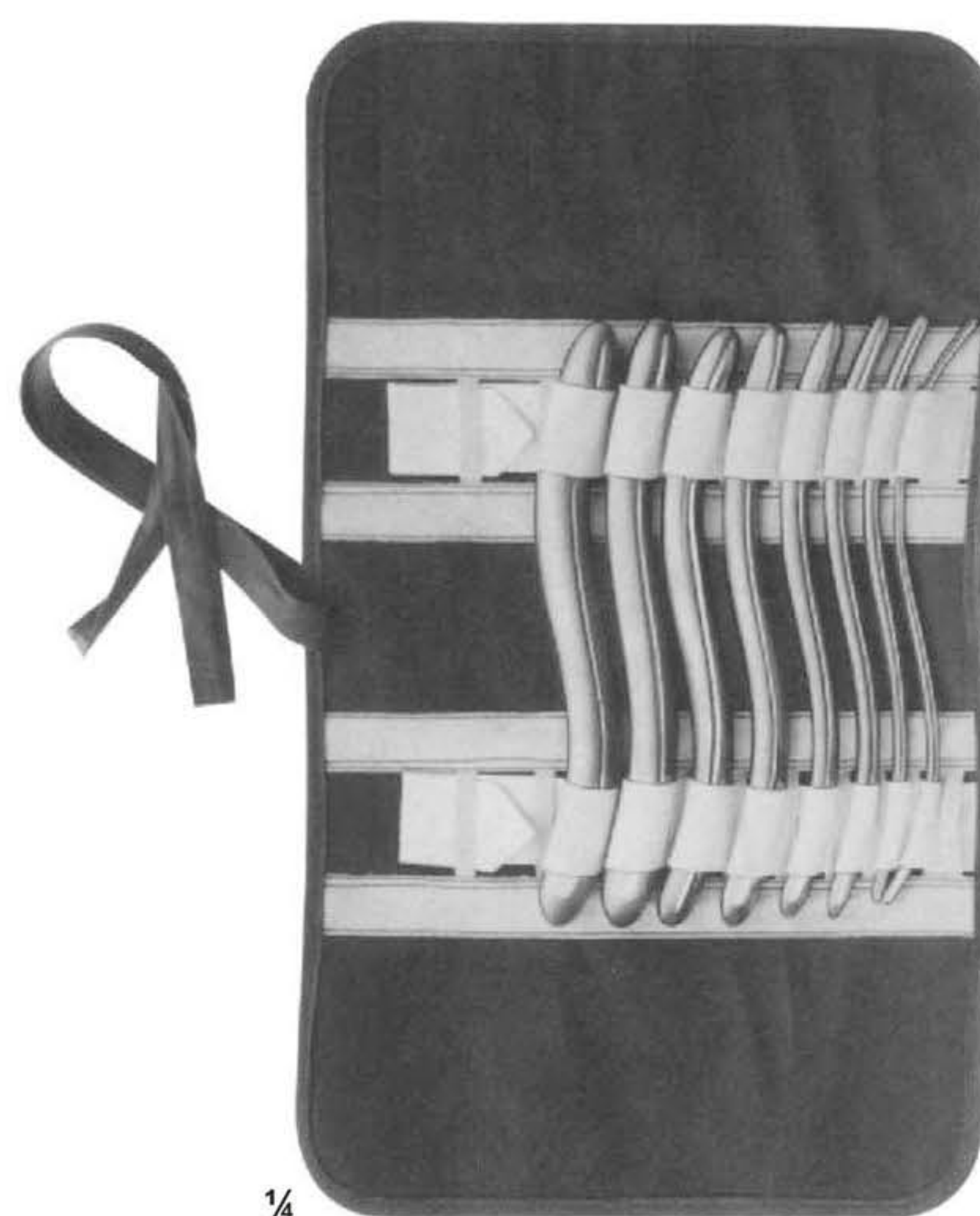

1/4

**13-153**  
 HEGAR  
 Uterine dilator set, in canvas  
 roll with 8 dilators.



## Uterine Dilators - Complete Sets



**13-154**  
HEGAR  
Dilator set consisting of:  
14 Dilators,  
1 Rack for dilators ( 4 - 12 mm )  
1 Rack for Dilators ( 13 - 17 mm )  
1 Metal case only,  
with hinged lid, stainless 200 X 100 X 35 mm

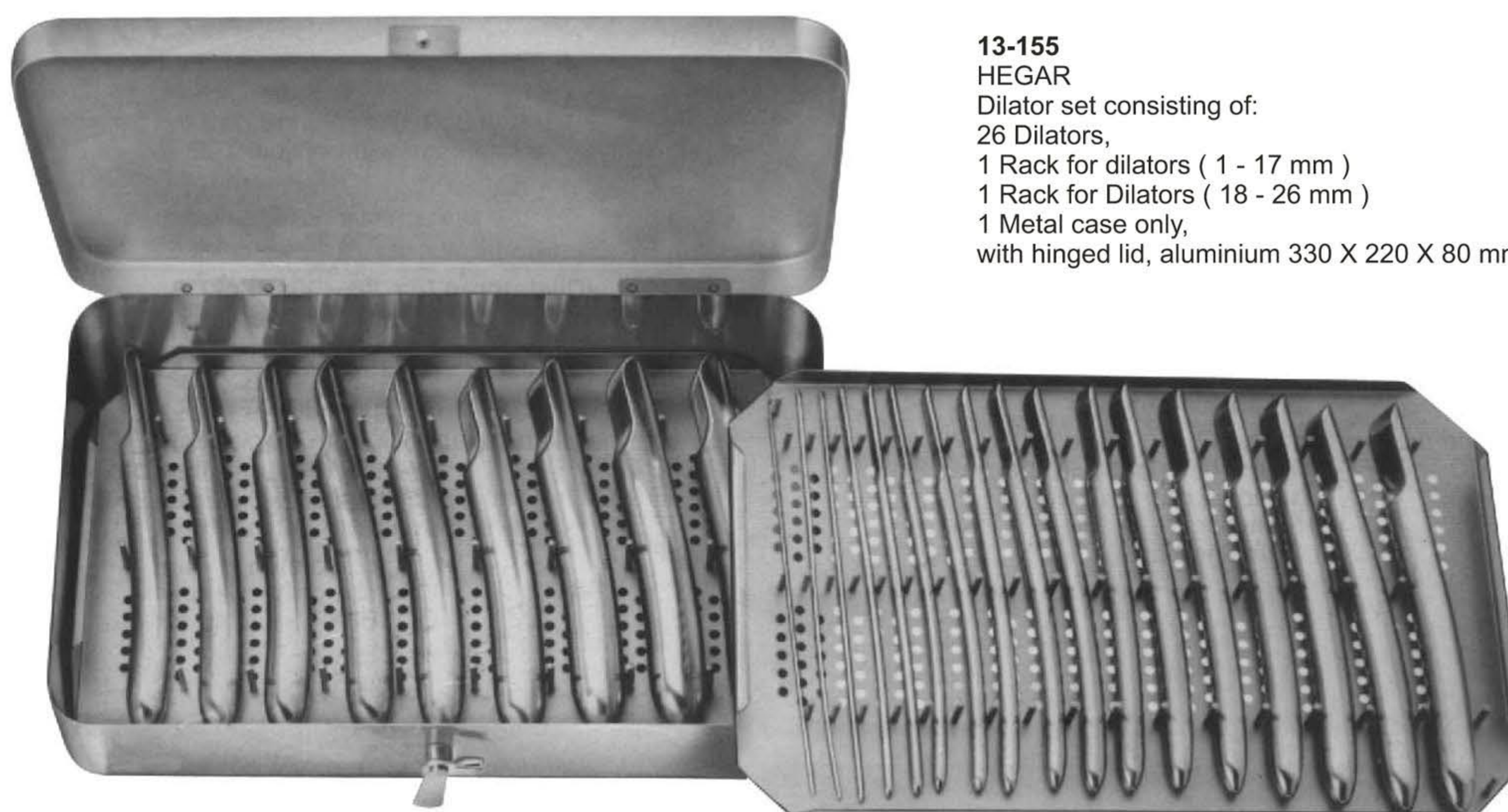

**13-155**  
HEGAR  
Dilator set consisting of:  
26 Dilators,  
1 Rack for dilators ( 1 - 17 mm )  
1 Rack for Dilators ( 18 - 26 mm )  
1 Metal case only,  
with hinged lid, aluminium 330 X 220 X 80 mm



## Endospecula For Cervix

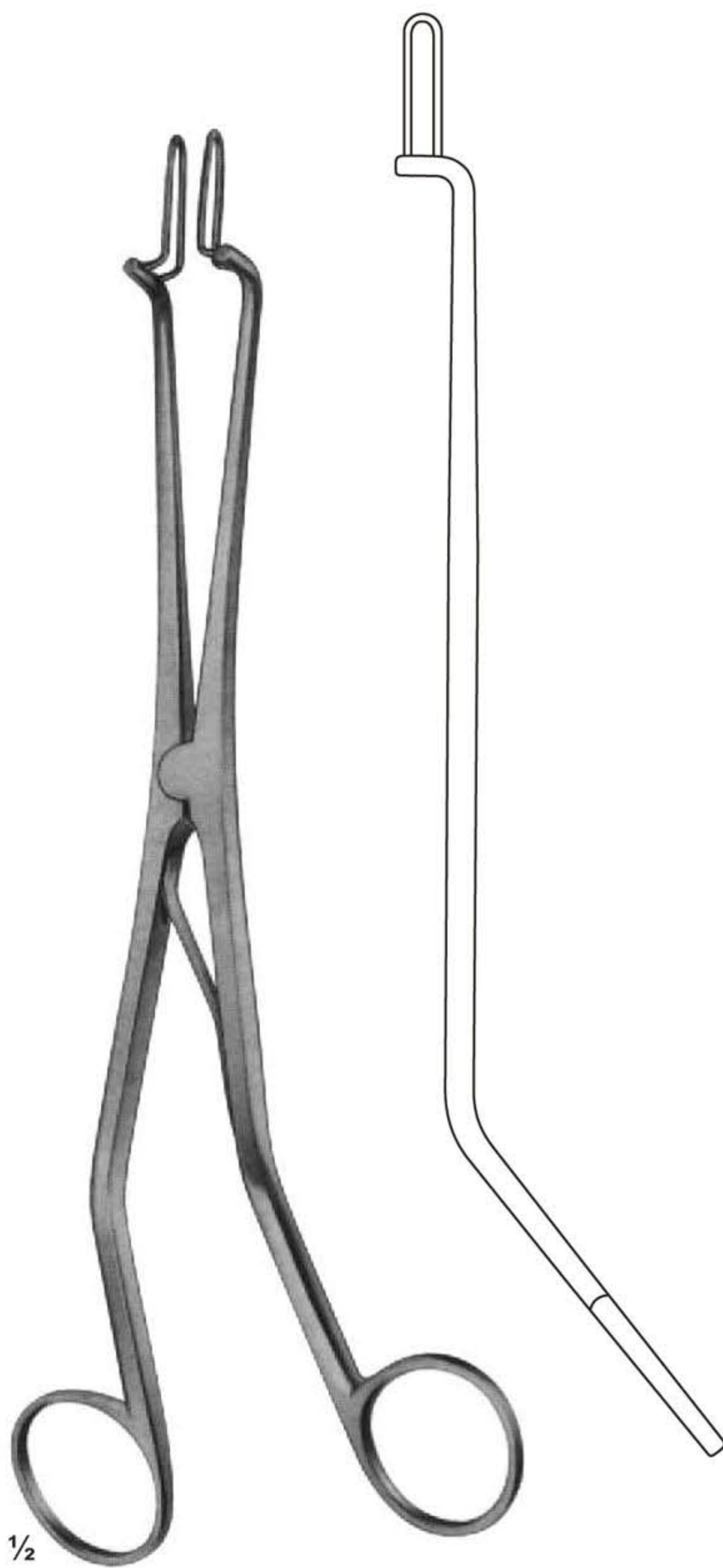

**13-156**  
KOGAN  
Endospecula for cervix  
and urethra, without ratchet  
240 mm

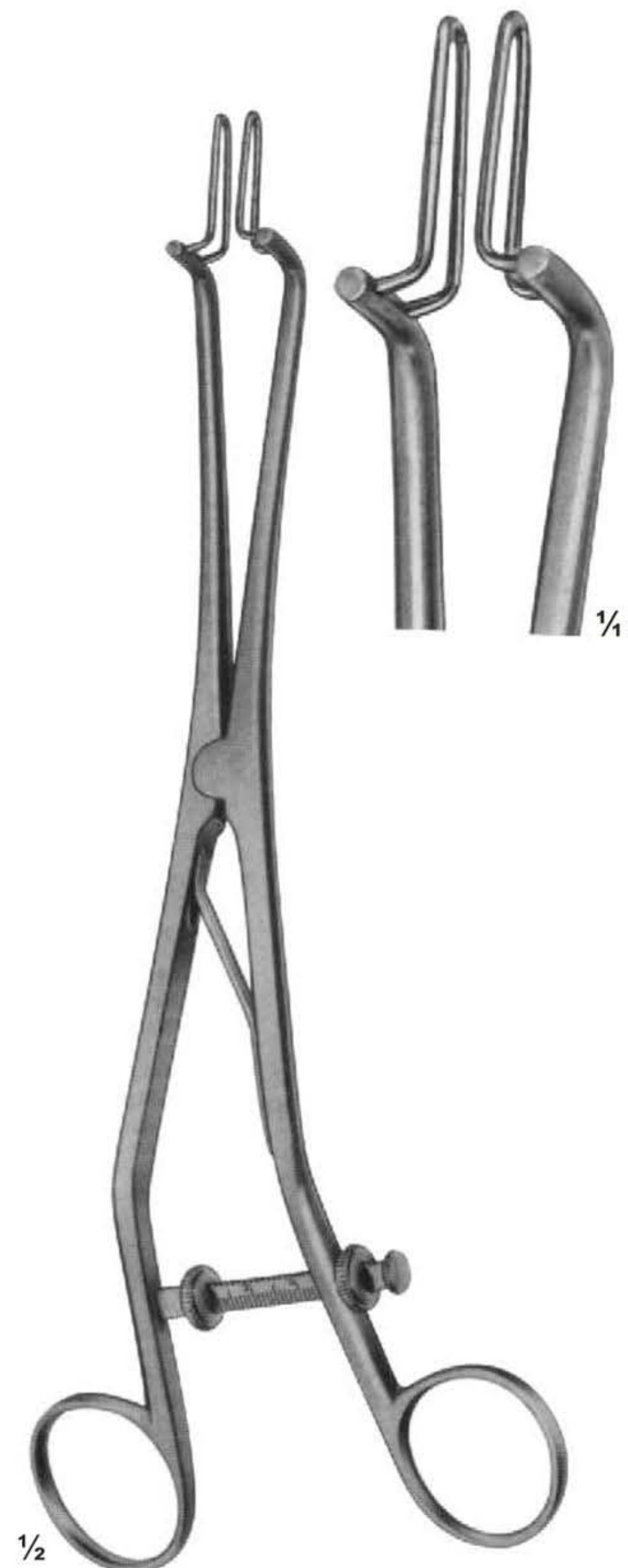

**13-157**  
KOGAN  
Endospecula for cervix  
and urethra, with  
scale-ratchet and fixing screws  
240 mm



**Uterine Probes**

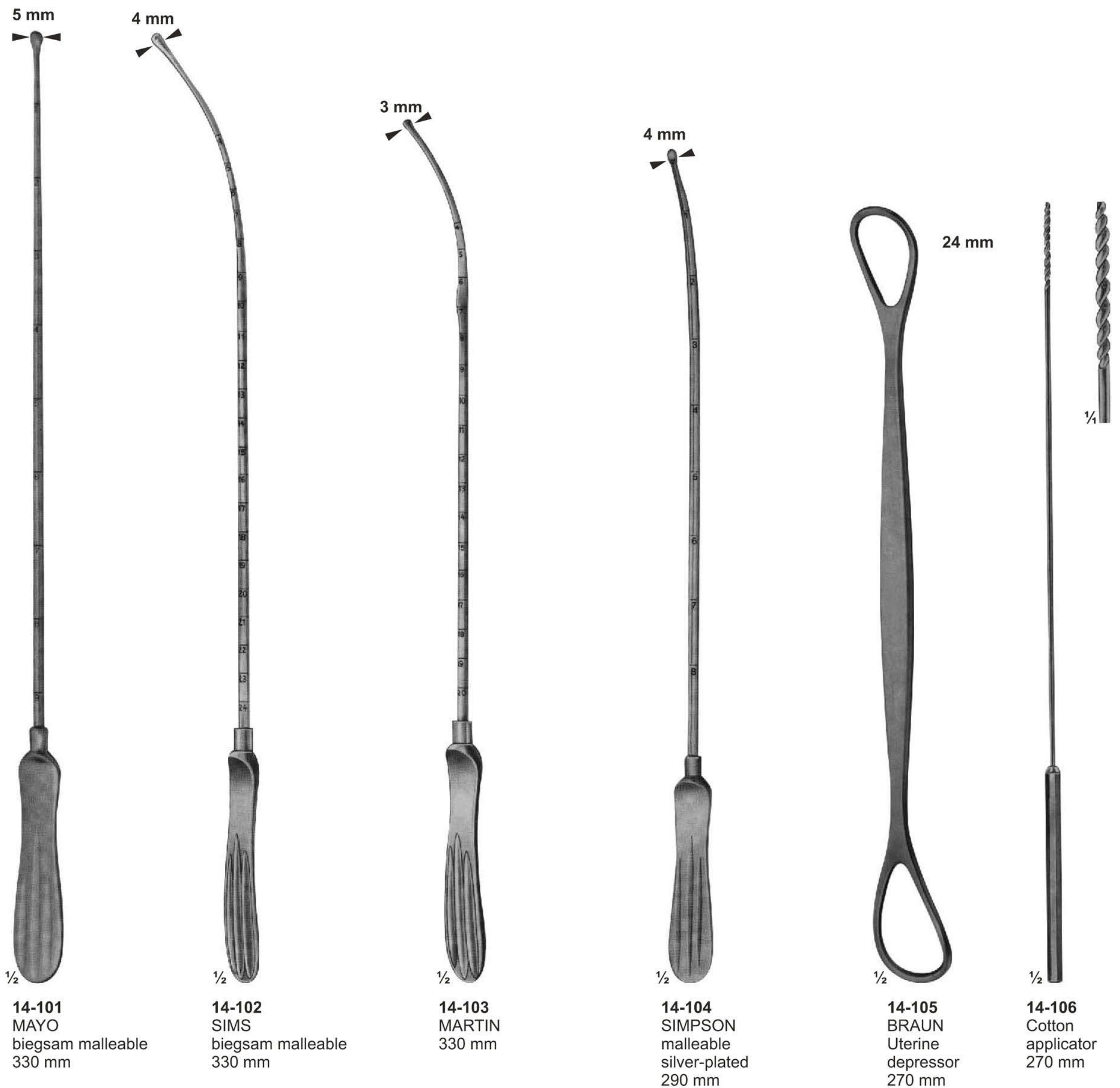



**Uterine Dressing Forceps**

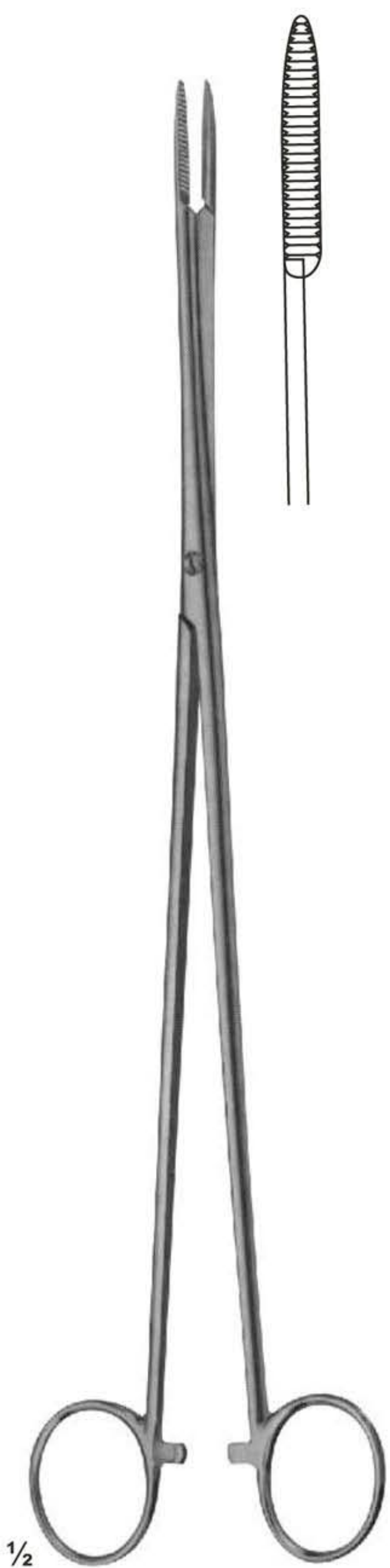

**14-107**  
PELKMAN  
260 mm

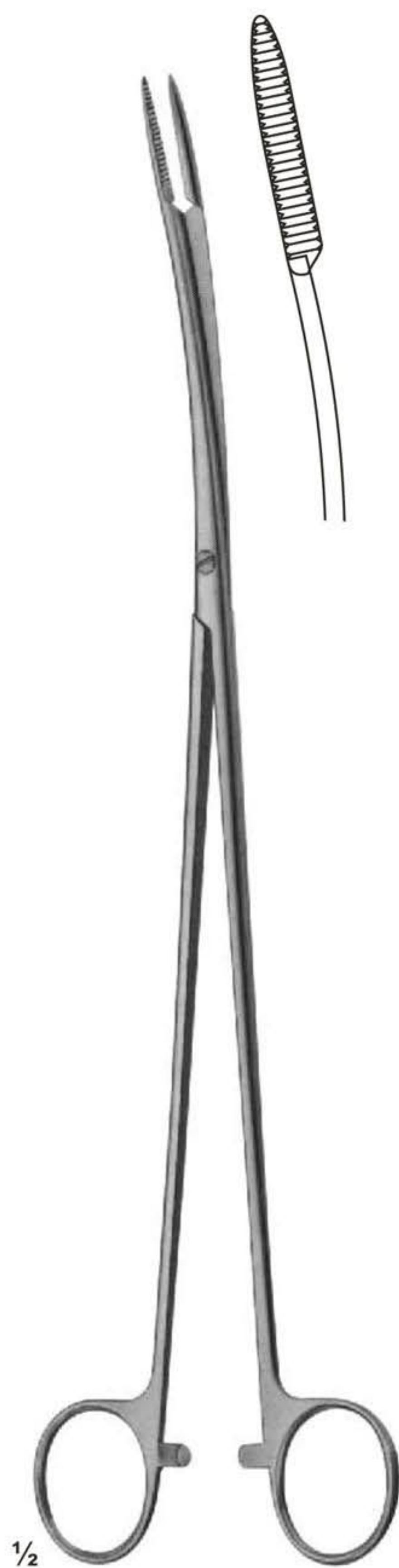

**14-108**  
PELKMAN  
260 mm

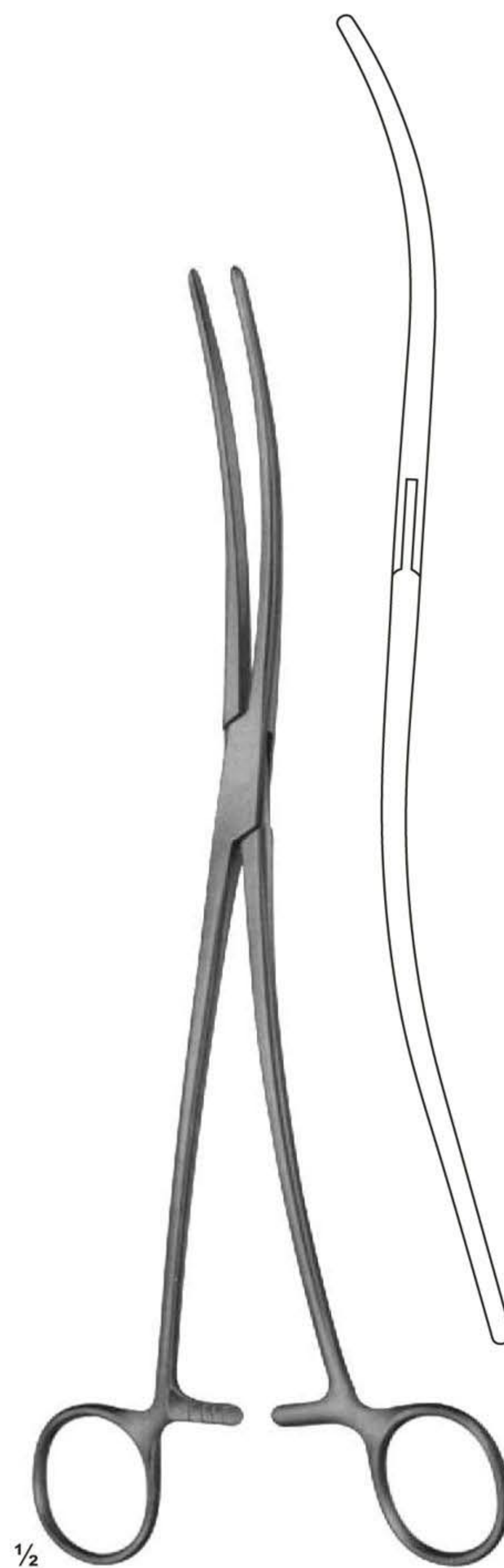

**14-109**  
BOZEMANN  
250 mm

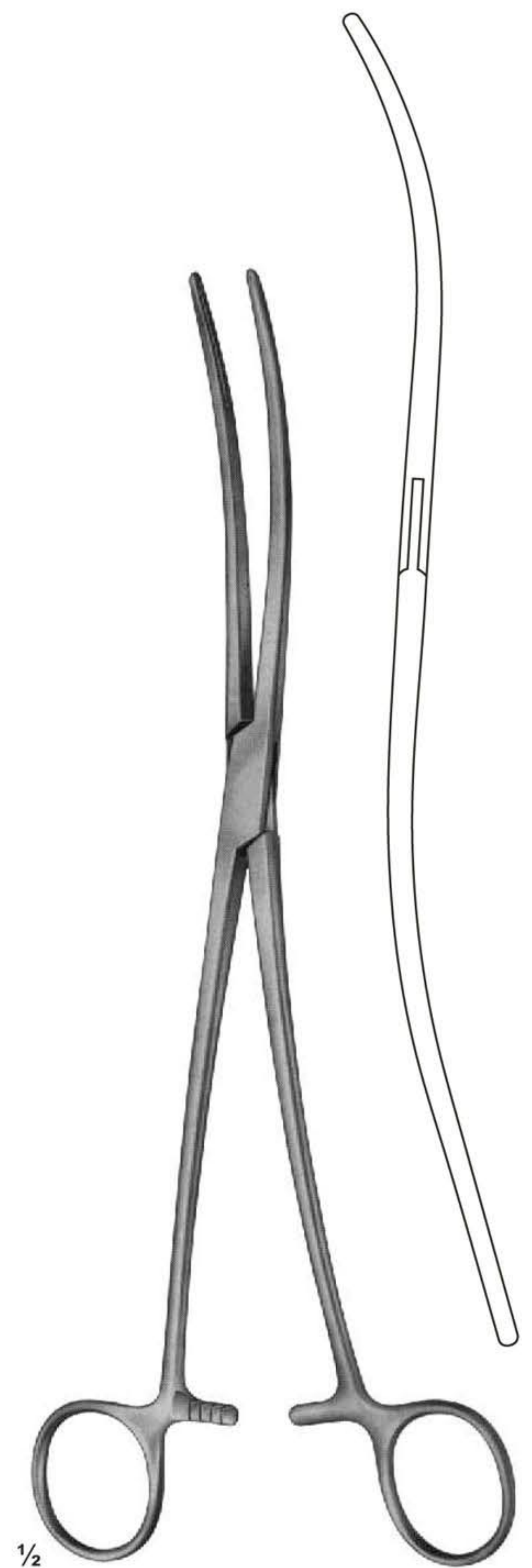

**14-110**  
BOZEMANN  
255 mm

Jaws with longitudinal groove



# Uterine Dressing Forceps

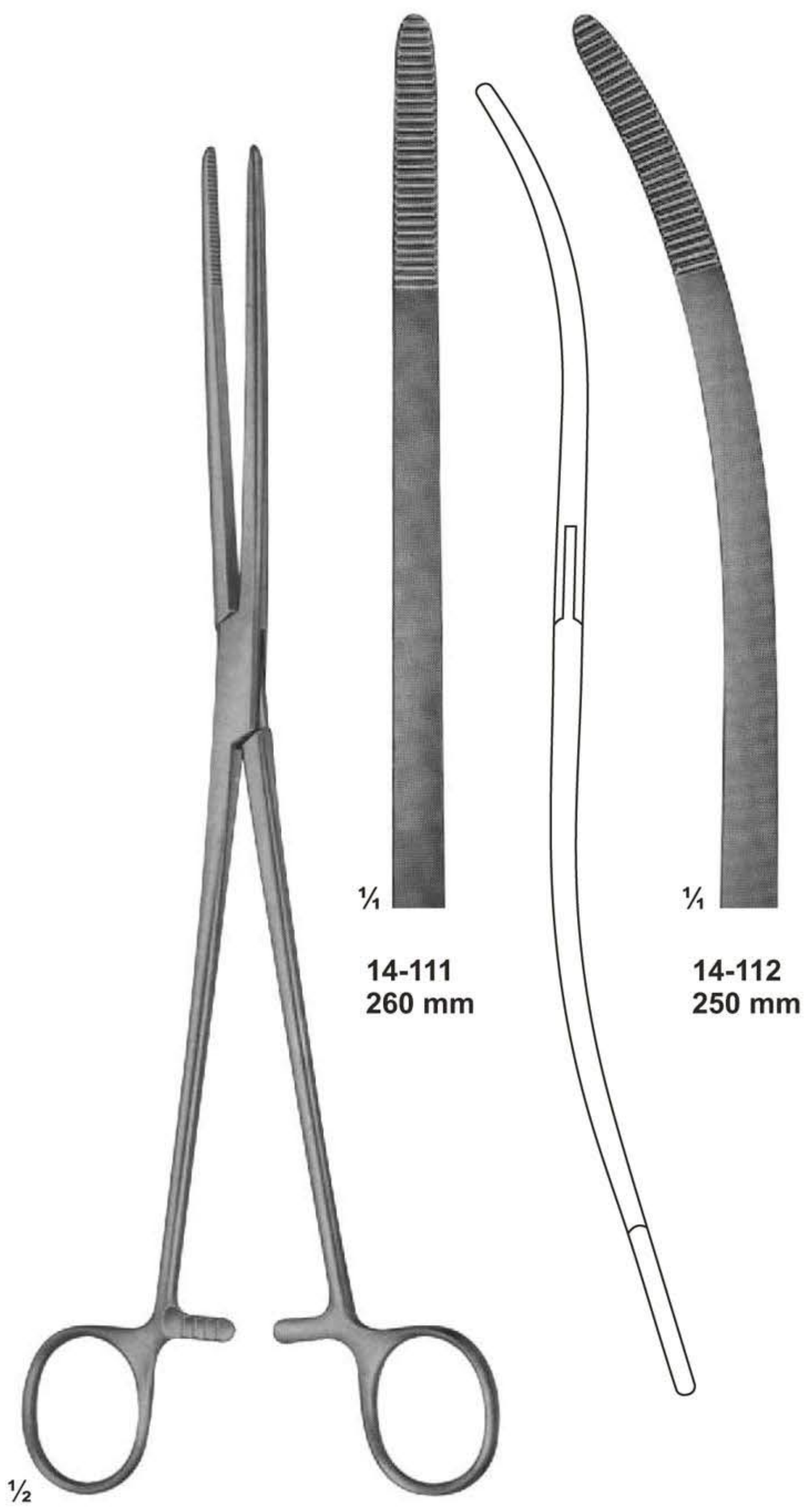

**14-111 - 112**  
BOZEMANN



**14-113**  
BOZEMANN-DOUGLAS  
260 mm



# Uterine Tenaculum Forceps

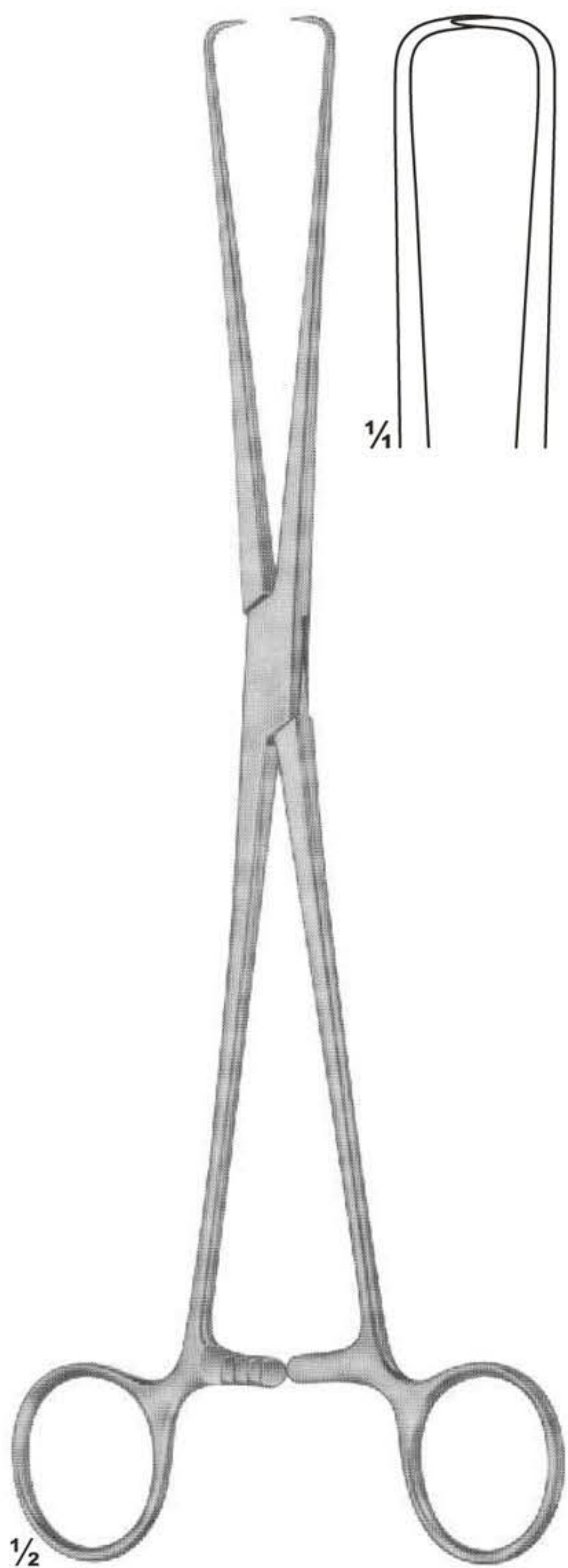

**14-114**  
BRAUN  
slender type  
250 mm



**14-115**  
SCHRODER  
250 mm



**14-116**  
POZZI  
heavy type  
255 mm



# Uterine Tenaculum Forceps

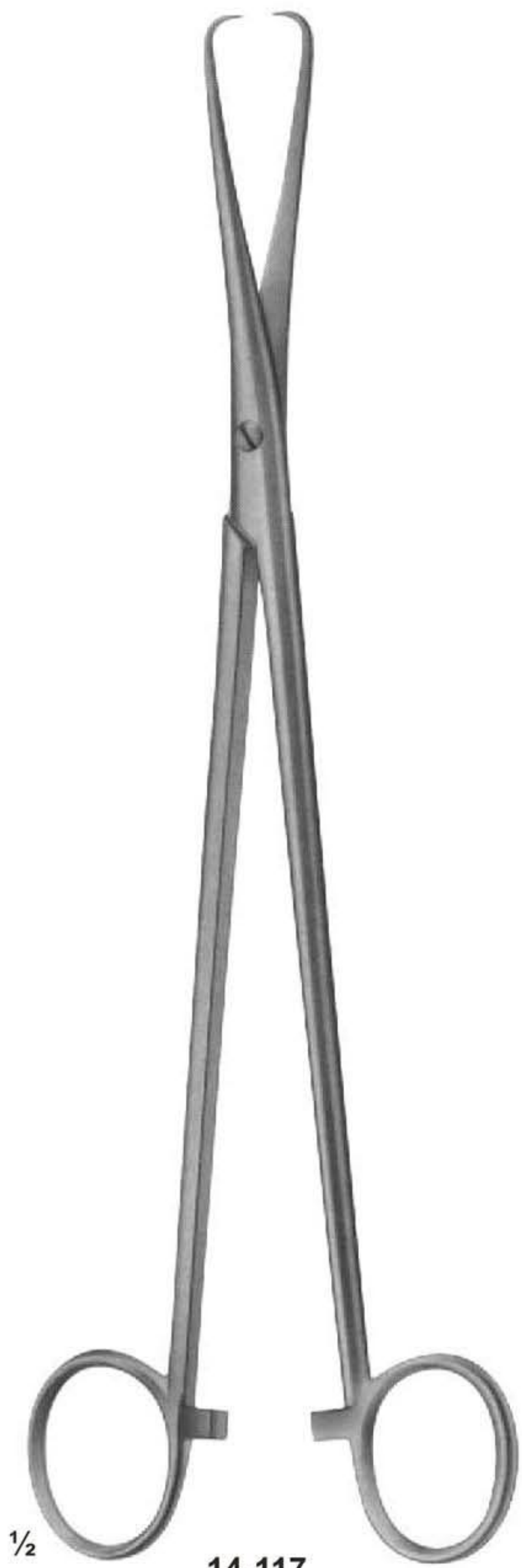

**14-117**  
265 mm

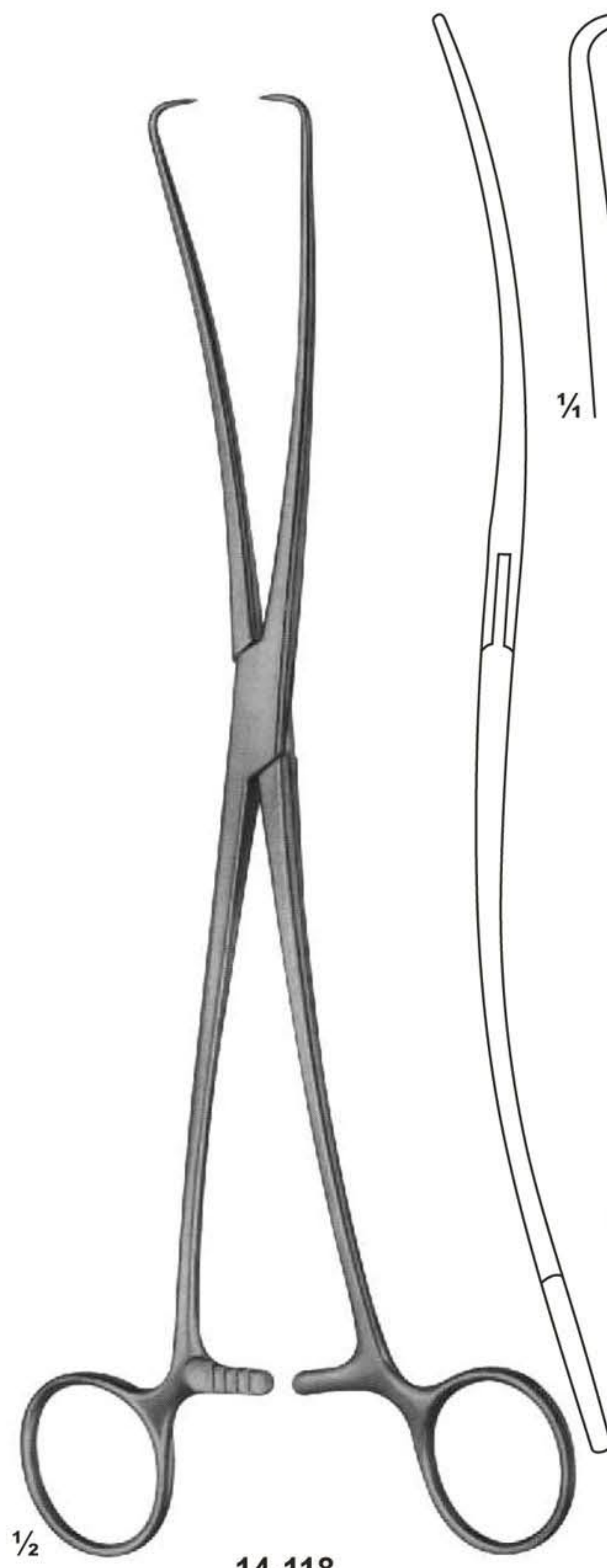

**14-118**  
DUPLAY  
250 mm

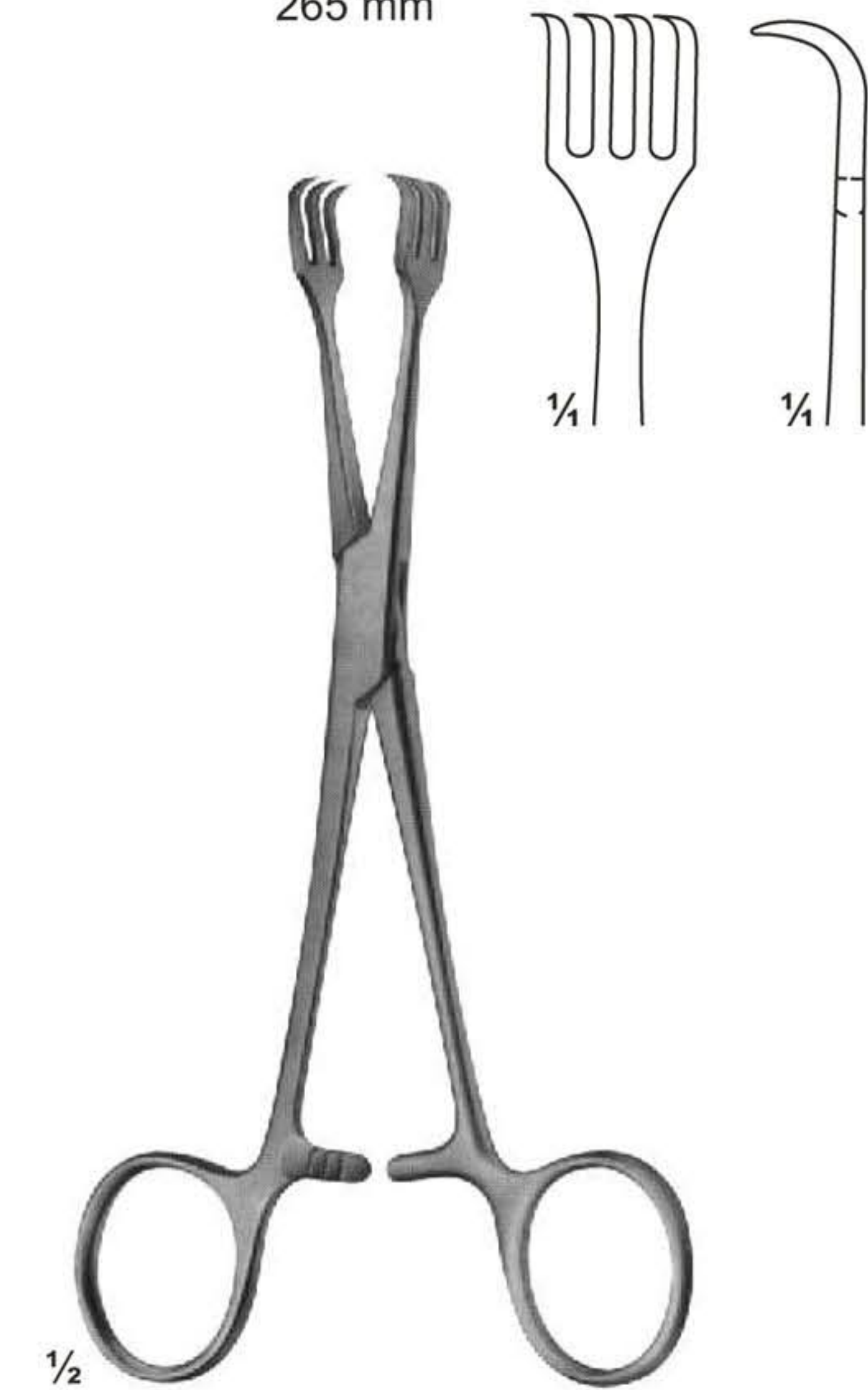

**14-119**  
LAHEY  
155 mm

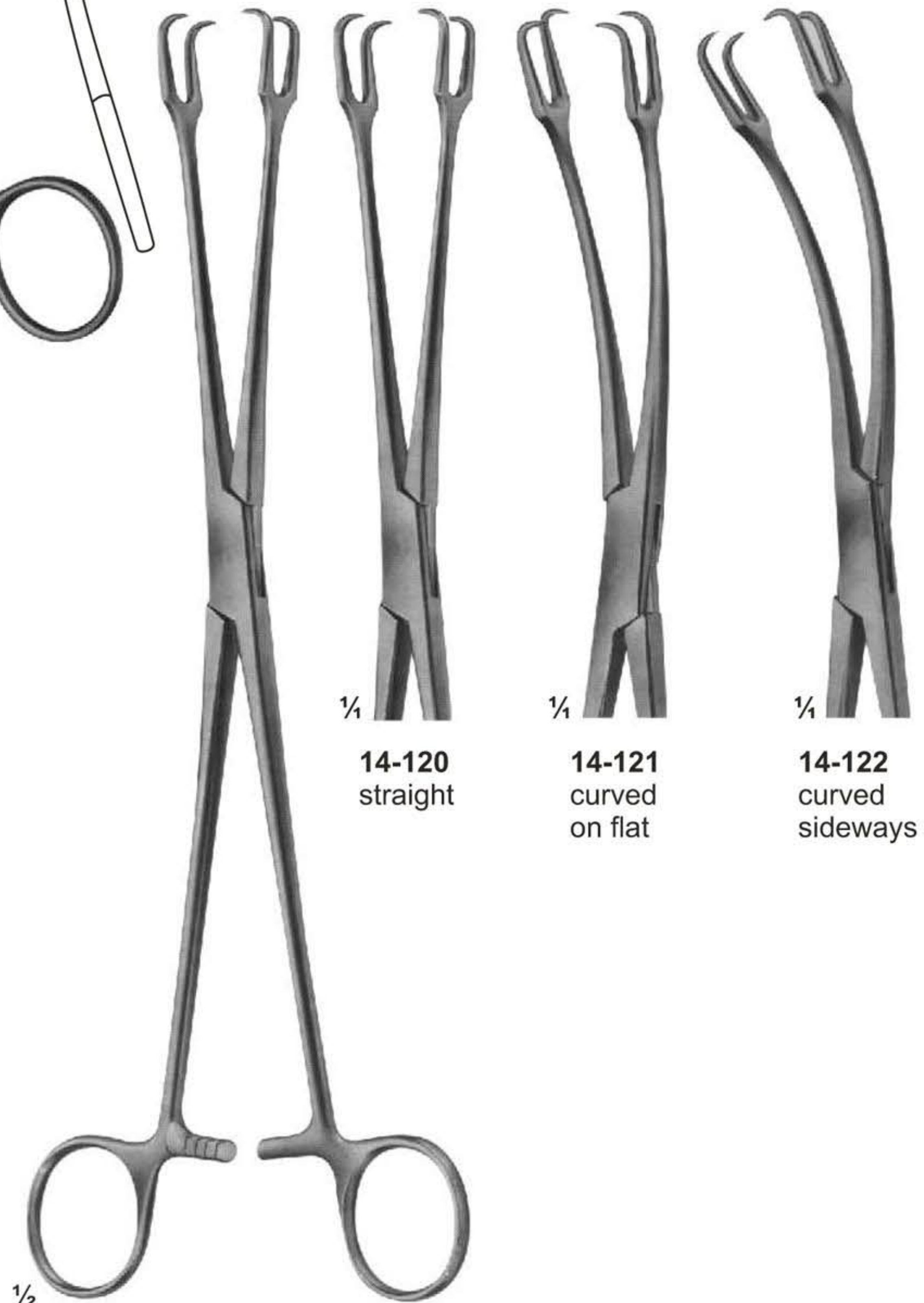
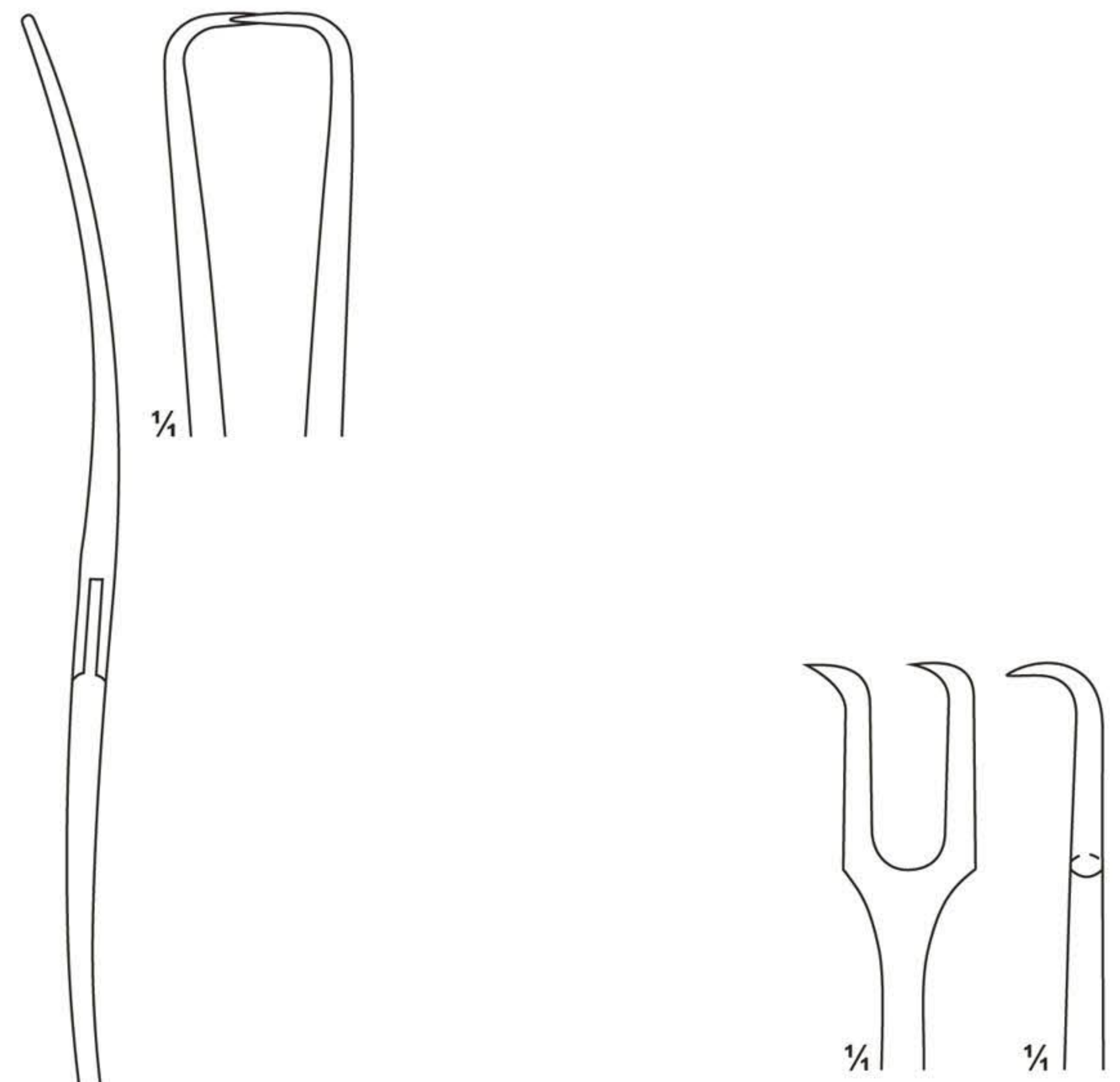

**14-120 - 122**  
SCHRODER  
250 mm

**14-120**  
straight

**14-121**  
curved  
on flat

**14-122**  
curved  
sideways



# Uterine Tenaculum Forceps

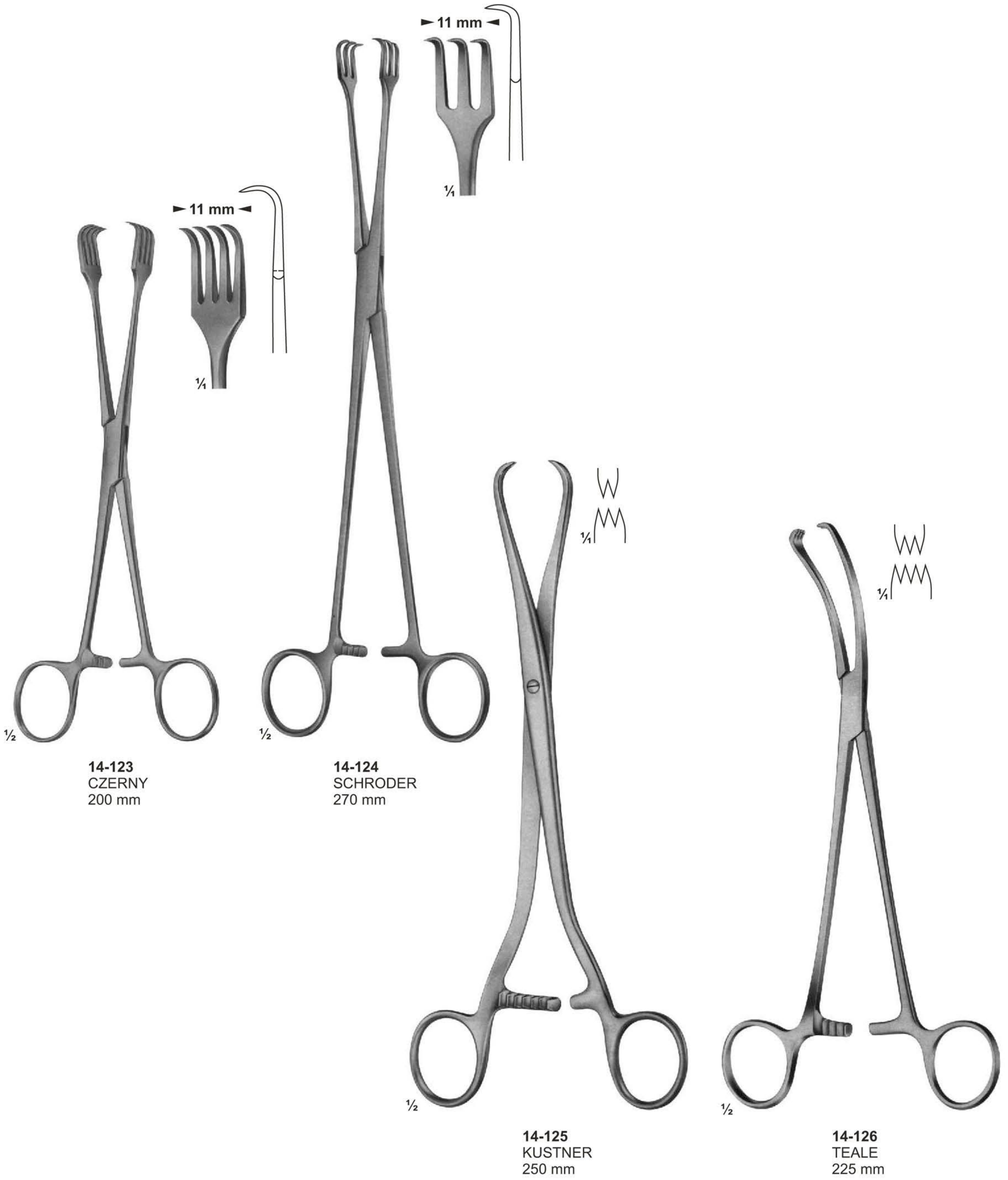



**Uterine Tenaculum Forceps**

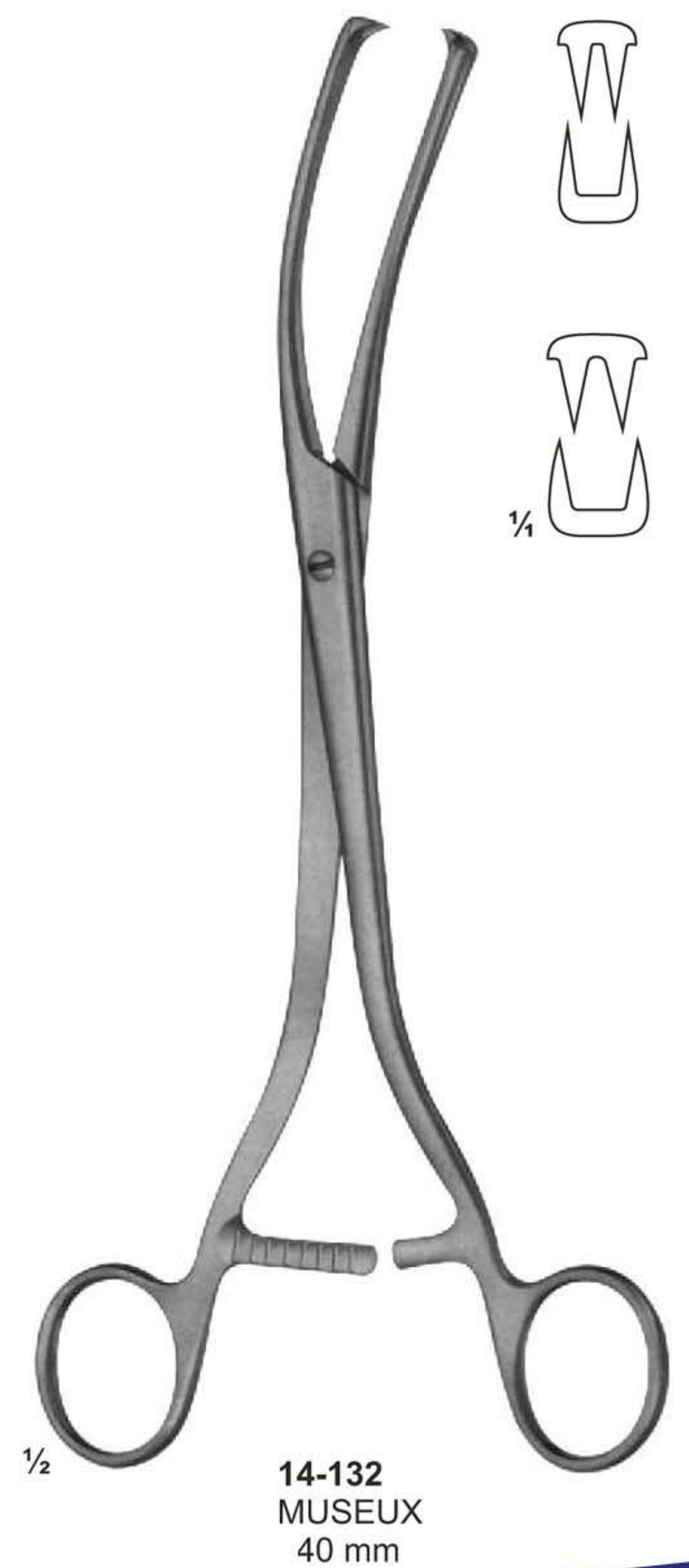
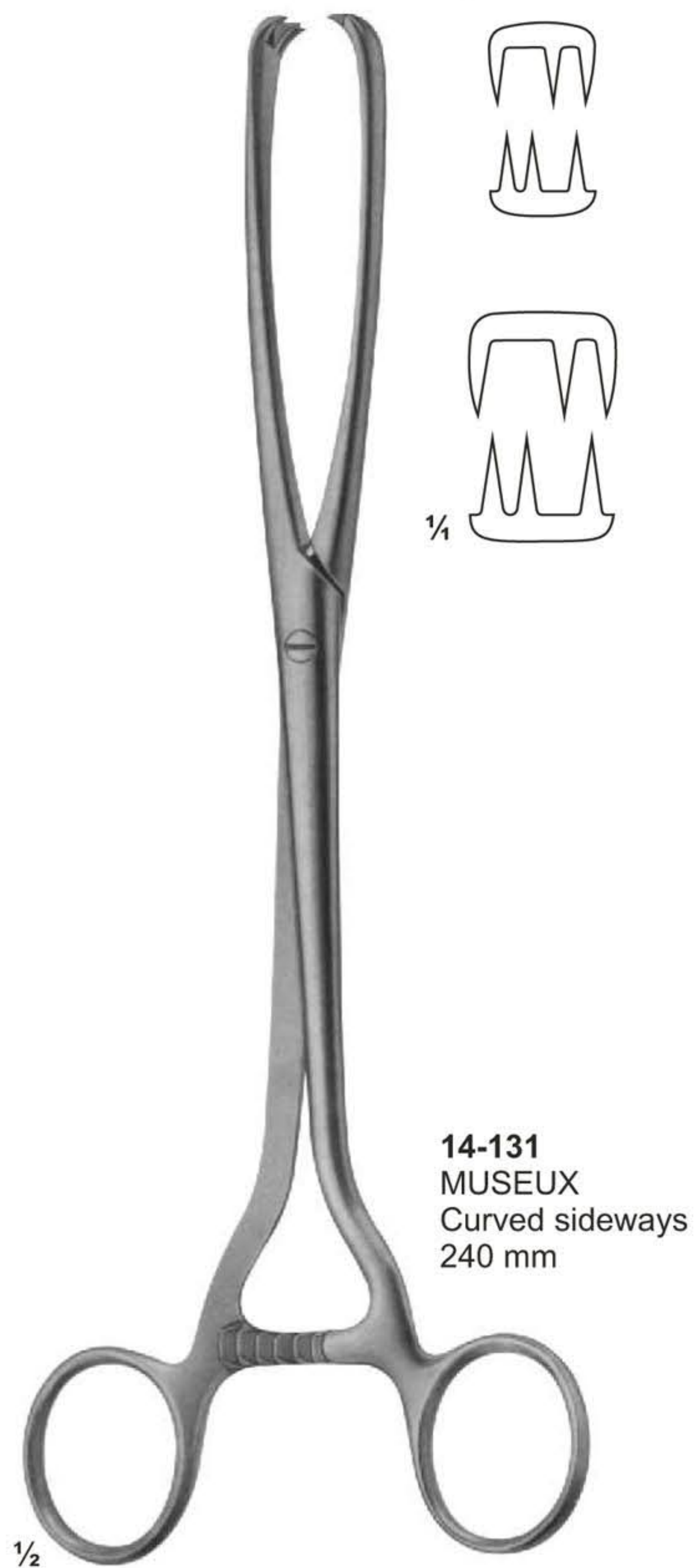
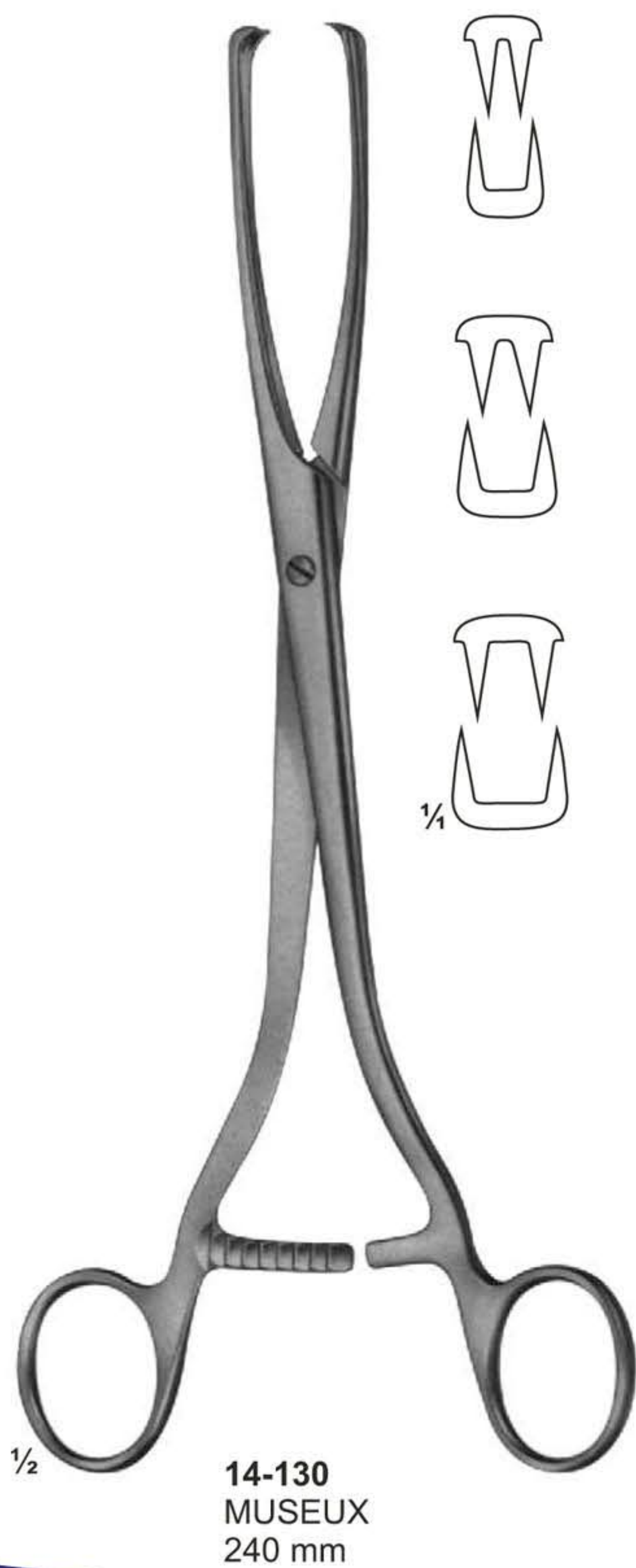



# Polypus-and Ovum Forceps

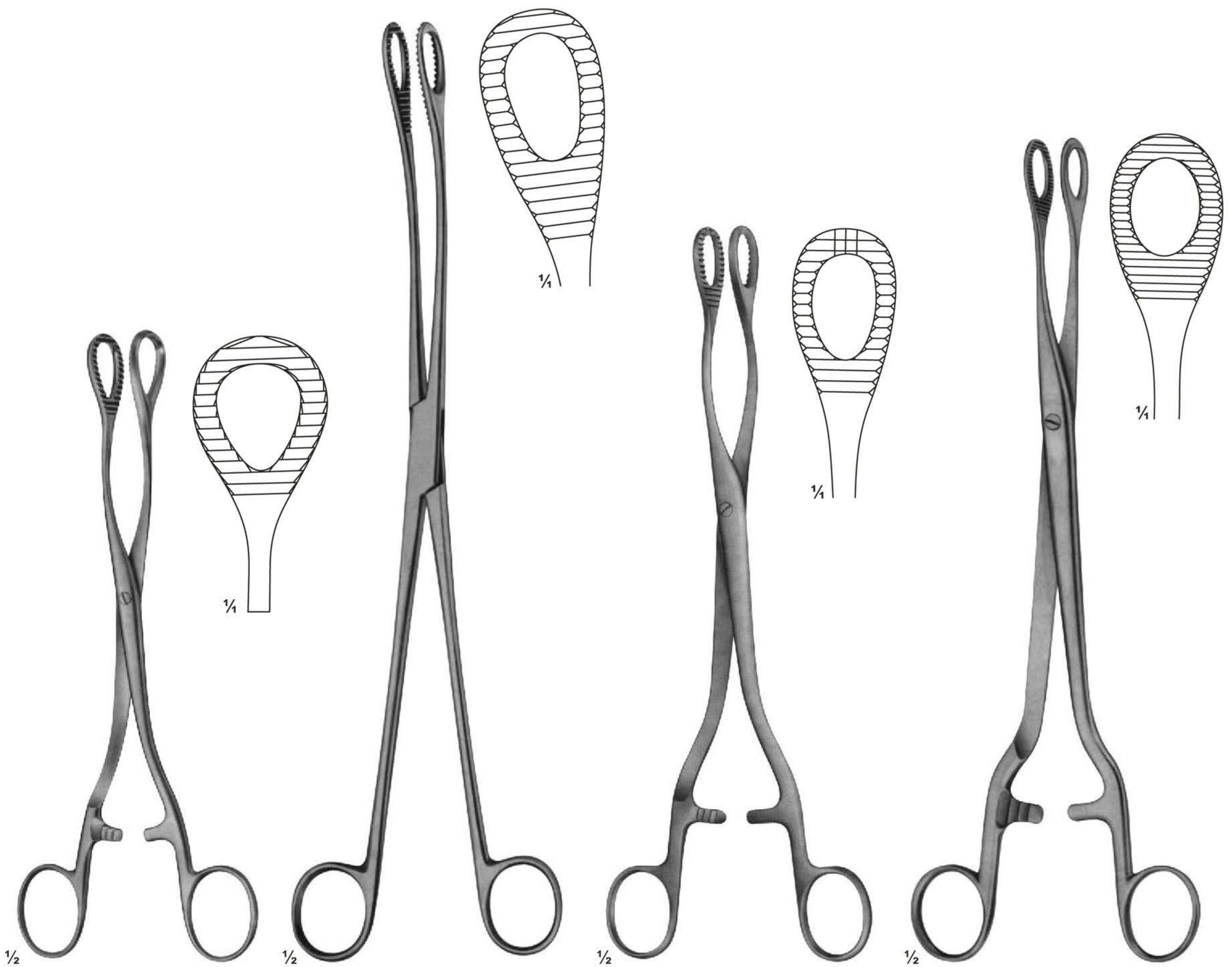

**14-133**  
HEYWOOD-SMITH  
200 mm

**14-134**  
KELLY  
320 mm

**14-135**  
HEYWOOD-SMITH  
250 mm

**14-136**  
NOTO  
280 mm



**Polypus and Ovum Forceps**



**14-138**

**14-139**



**14-137**  
DOYEN  
185 mm

**14-138 - 139**  
250 mm 270 mm

**14-140**  
BUMM  
280 mm



## Uterine Elevating Forceps

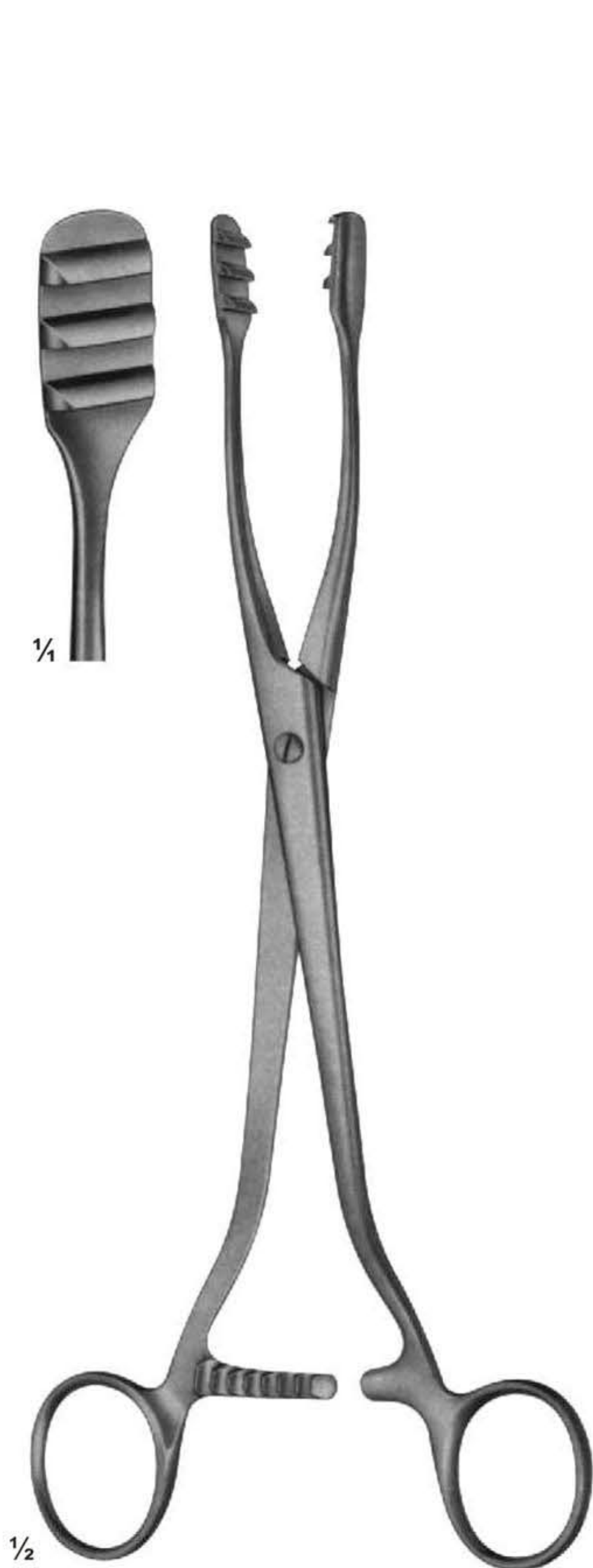

**14-141**  
COLLIN  
250 mm



**14-142**  
COLLIN  
285 mm



**14-143**  
DARTIGUES  
255 mm



## Uterine Elevating Forceps



**14-144**  
SOMER  
235 mm



**14-145**  
STRASSMANN  
260 mm



# Uterine Elevating Forceps

With movable jaws



**14-146**  
COLLIN  
265 mm

With movable jaws



**14-147**  
260 mm



**Myoma Instruments**



**14-148**  
SEGOND  
Myomatome  
270 mm



**14-149**  
DOYEN  
Myoma screw  
150 mm



**14-150**  
DOYEN  
Myoma screw  
190 mm

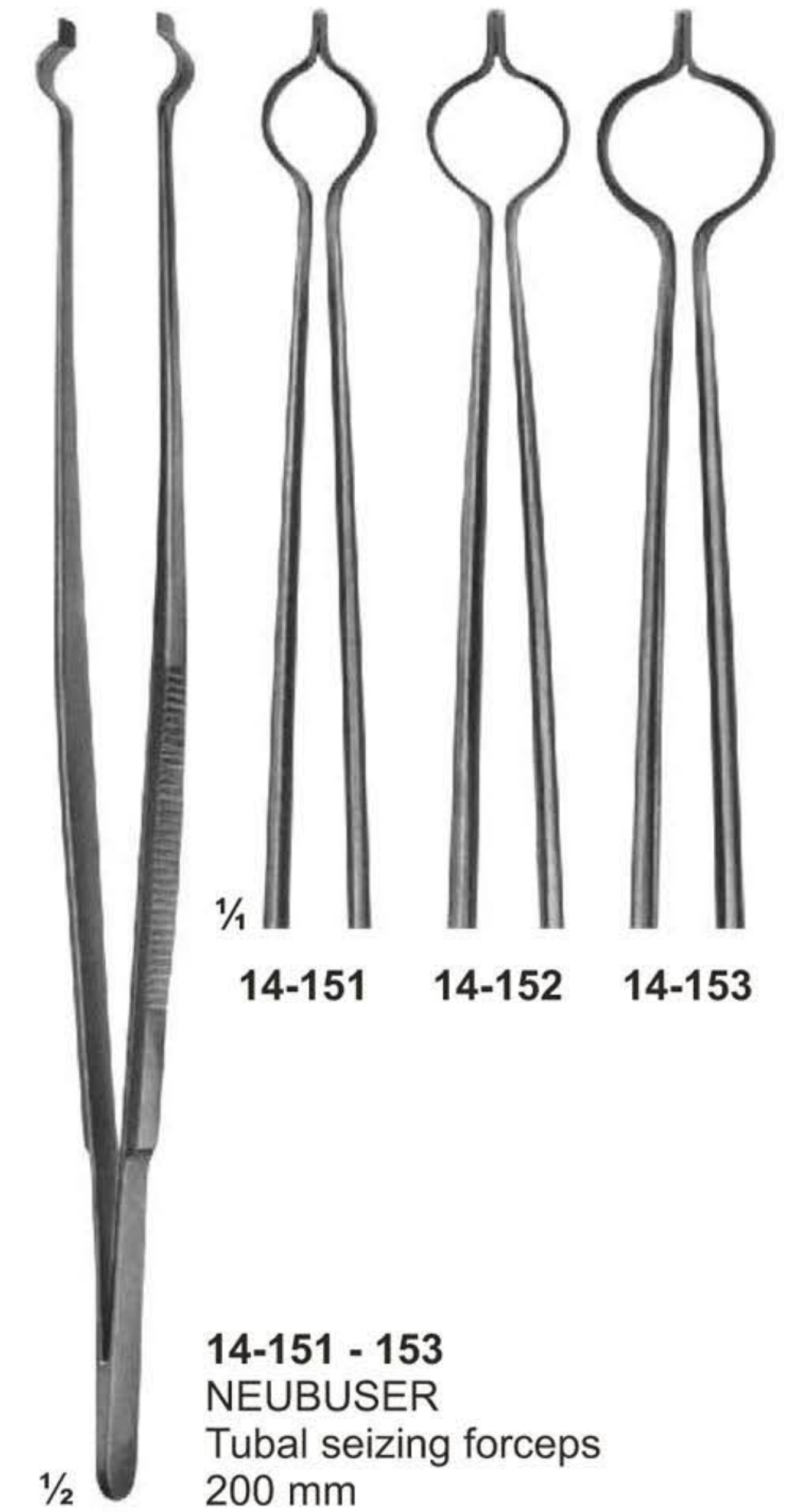

**14-151 - 153**  
NEUBUSER  
Tubal seizing forceps  
200 mm



**14-154**  
Splint guide  
with thread



**14-155**  
Splint guide with  
round handle  
180 mm



**14-156**  
Angled glass rods  
Set . 3 pieces



**14-157**  
Silicon operating pad  
pre-cut



**14-158**  
Polyäthylen splint material  
soft-sterile  
0.45 mm



# Biopsy Curettes

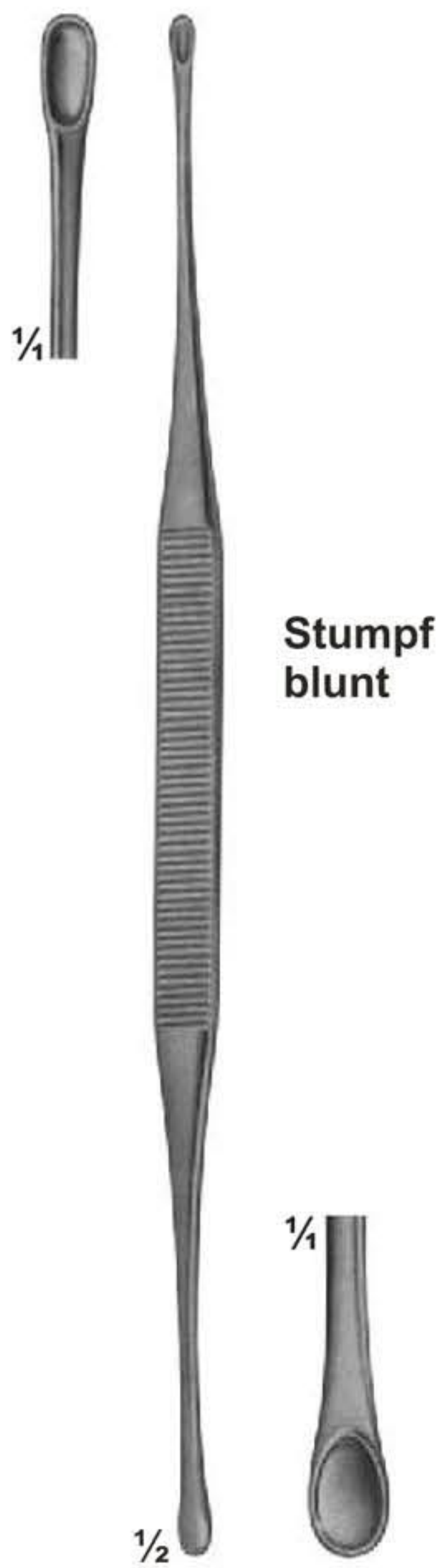

**15-101**  
ASCH  
Uterine  
Secretion scoop  
200 mm

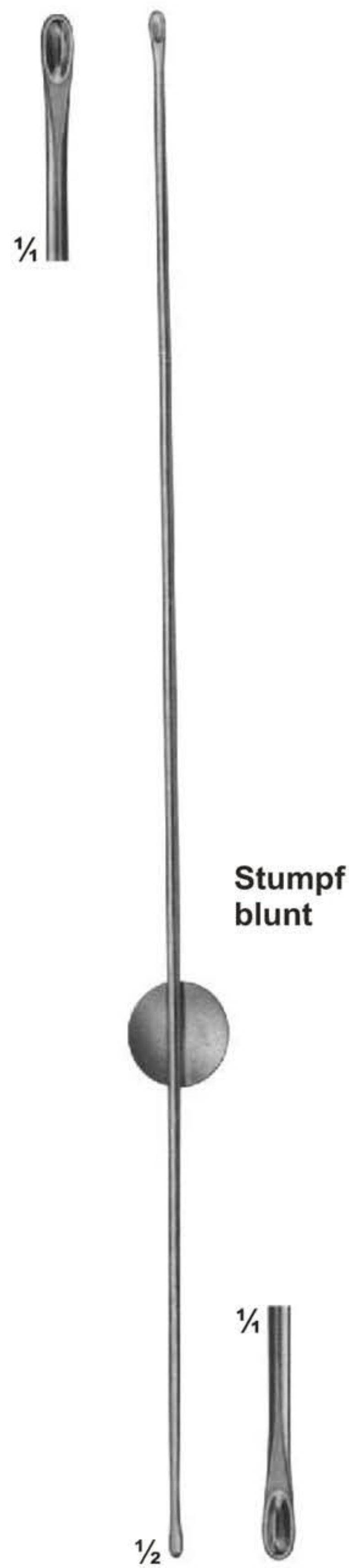

**15-102**  
Uterine  
Secretion scoop  
270 mm



**15-103**  
NOVAK-SCHOECKAERT  
Endometrial biopsy  
curette  
240 mm



**15-104**  
RANDALL  
Endometrial biopsy  
curette  
240 mm



# Biopsy Forceps

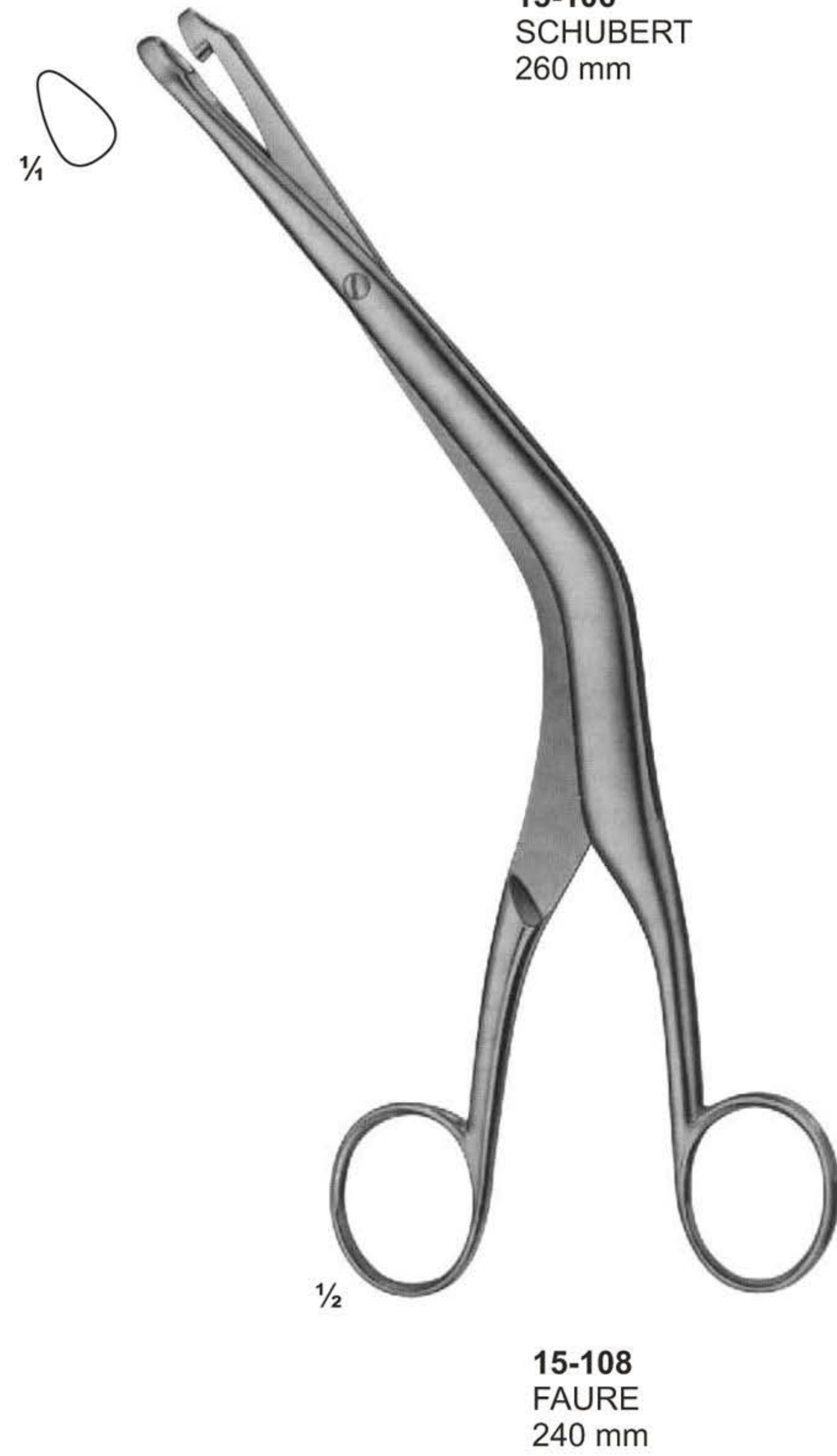
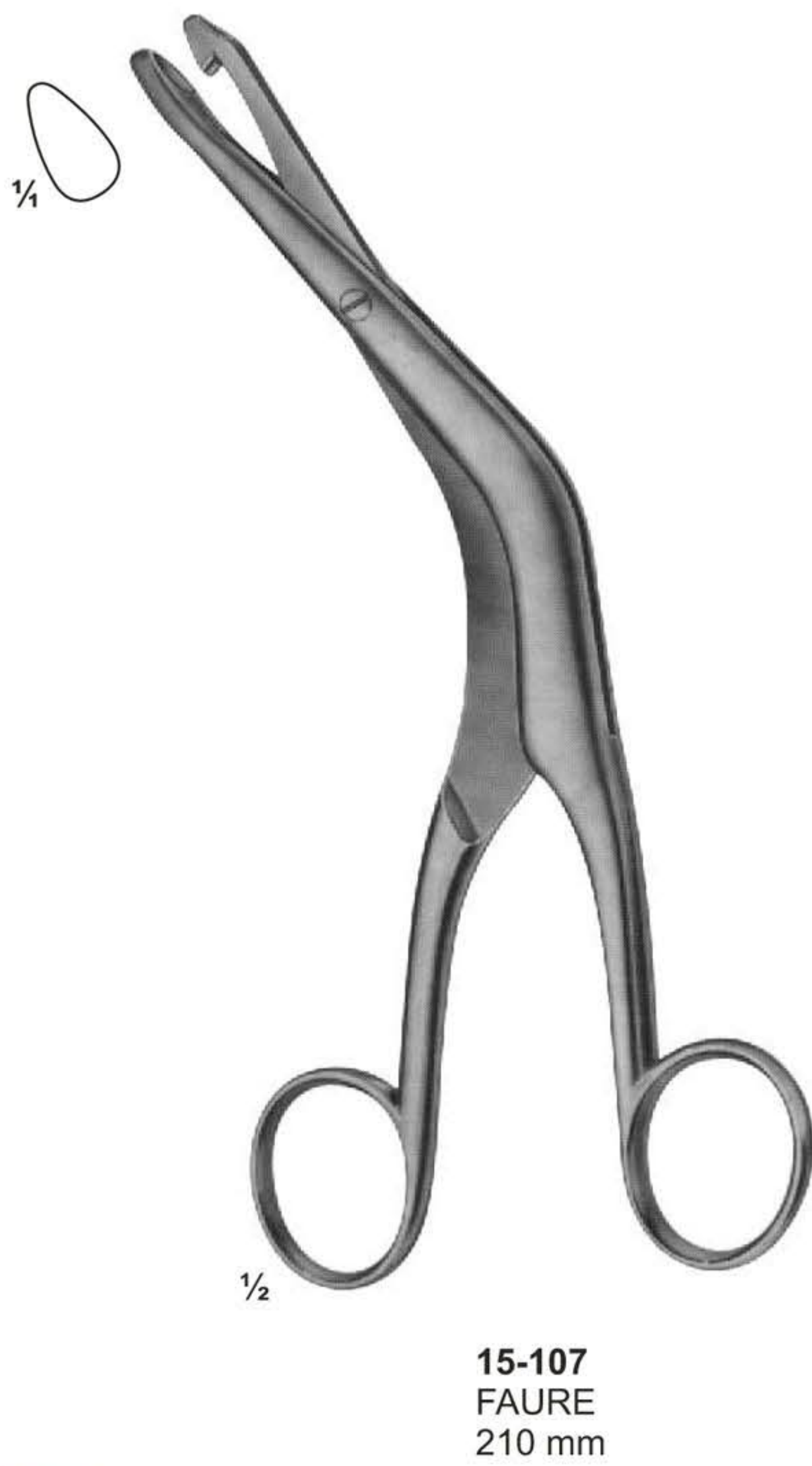
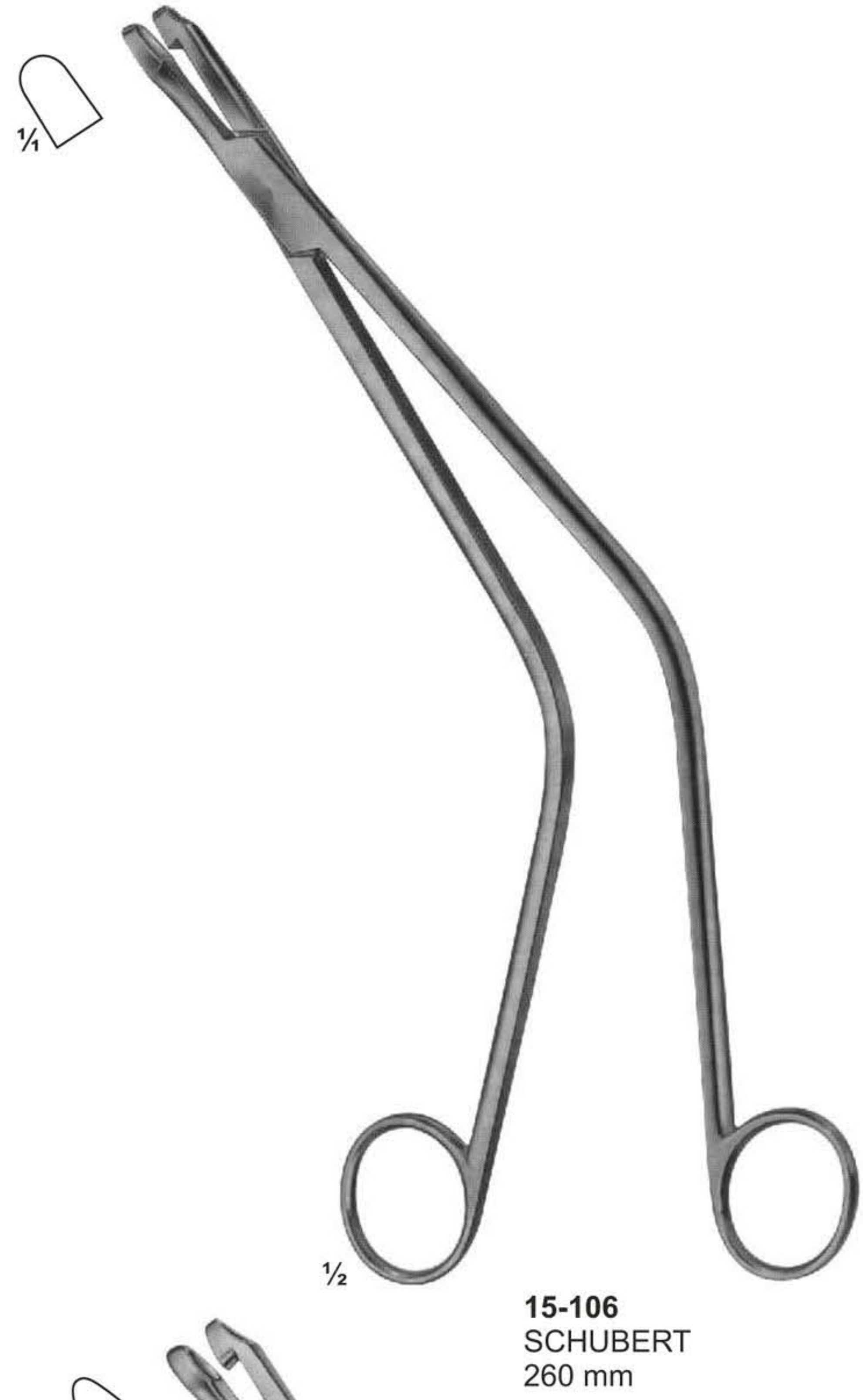
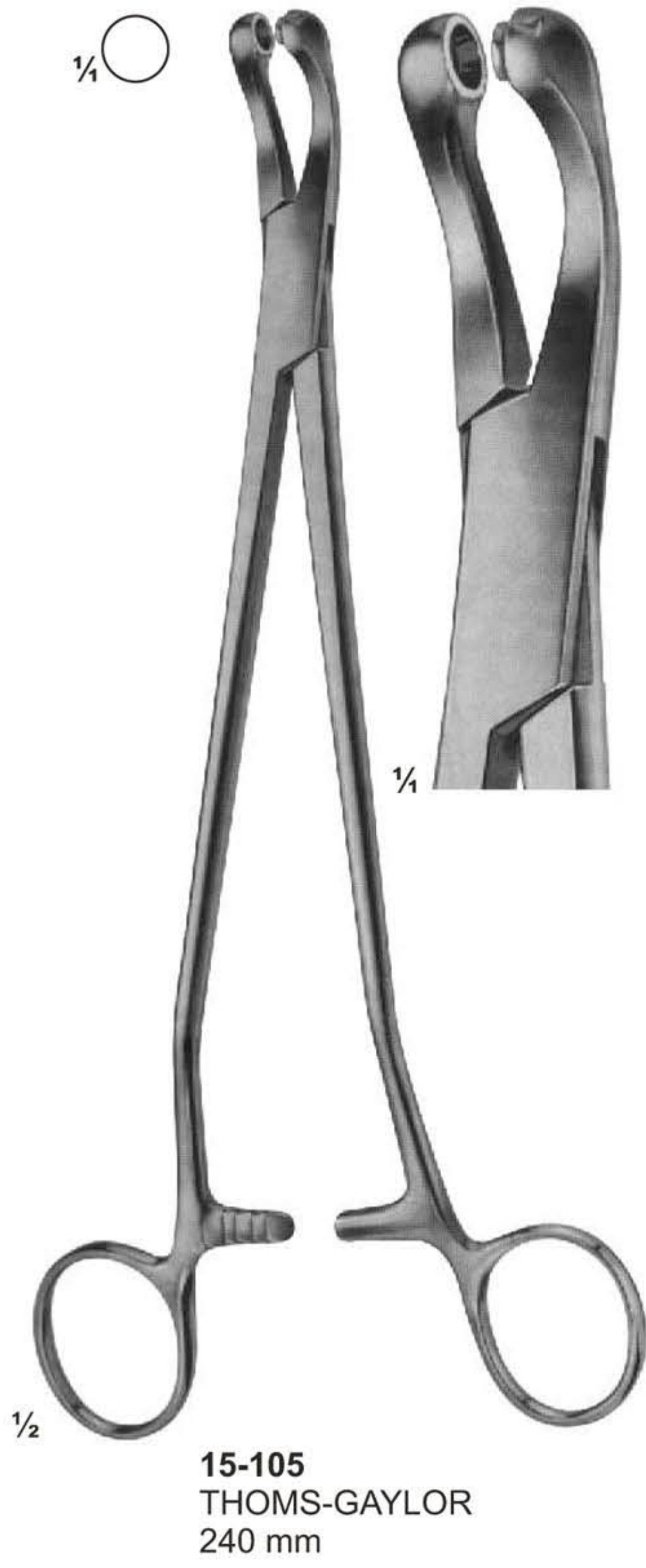



**Biopsy Forceps**

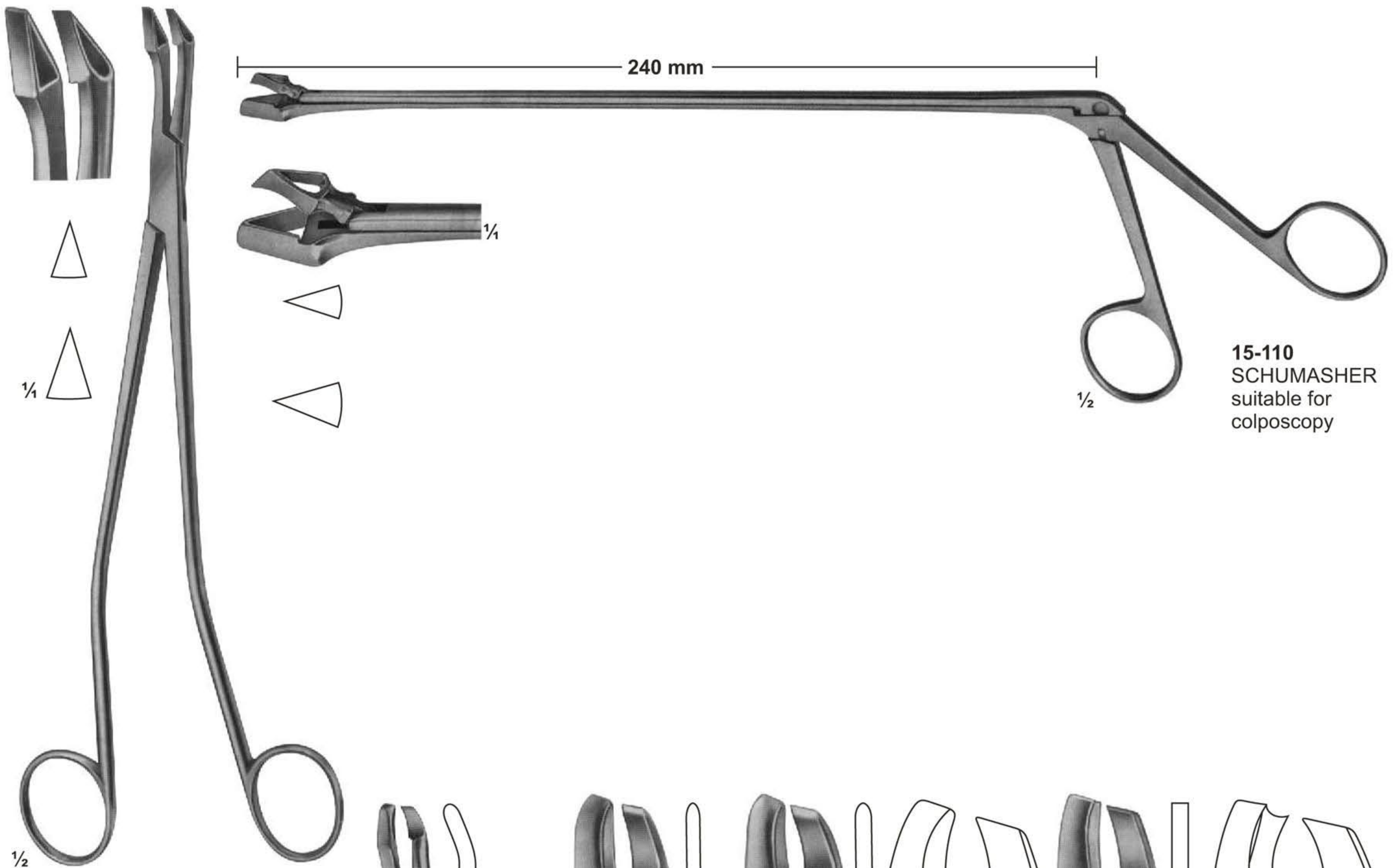

**15-109**  
SCHUMASHER  
240mm

**15-110**  
SCHUMASHER  
suitable for  
colposcopy

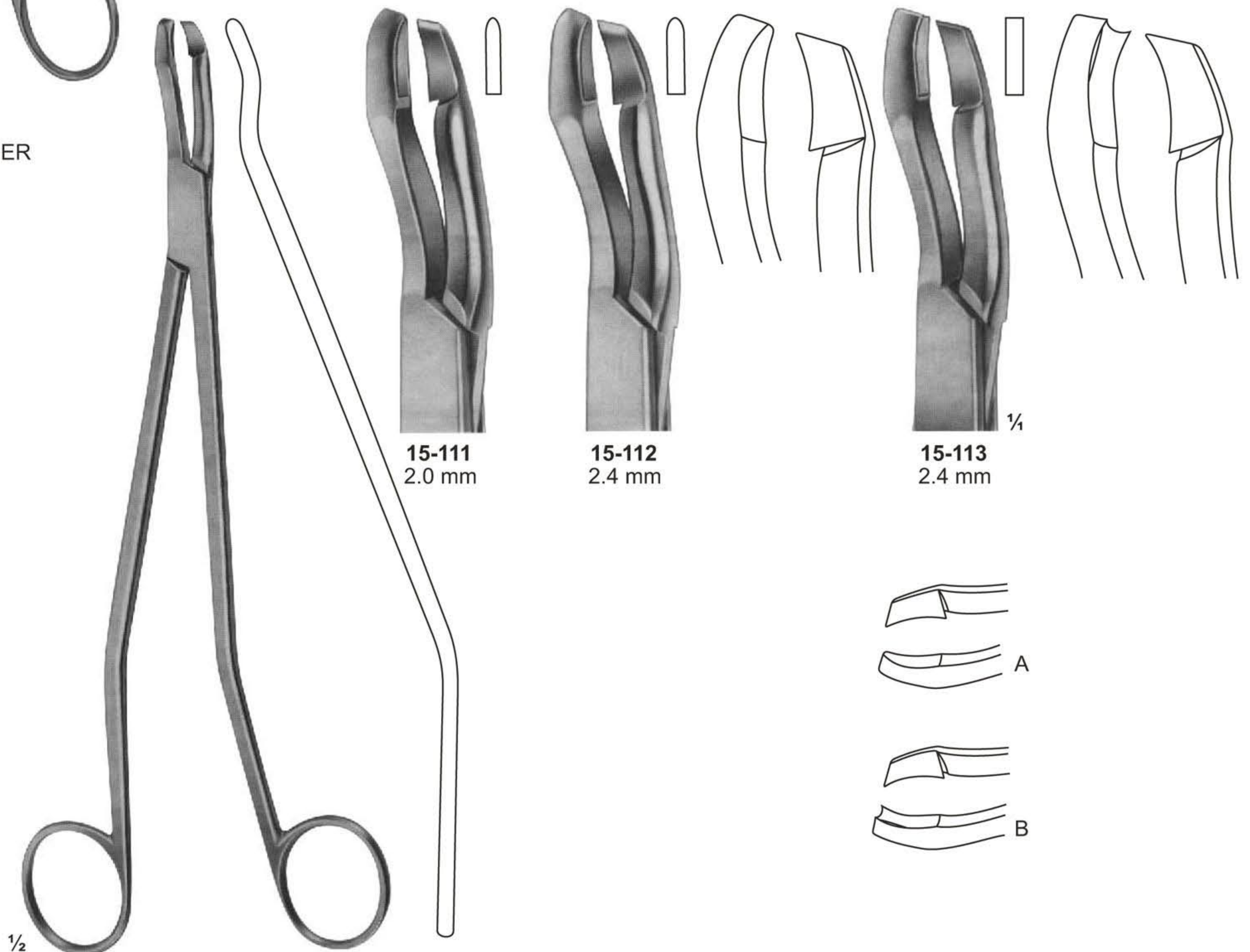

**15-111**  
2.0 mm

**15-112**  
2.4 mm

**15-113**  
2.4 mm

**15-111 - 113**  
SEIDL DBP  
Biopsy forceps, bayonet shaped  
for portio, vagina and vulva  
240mm



**Biopsy Forceps**

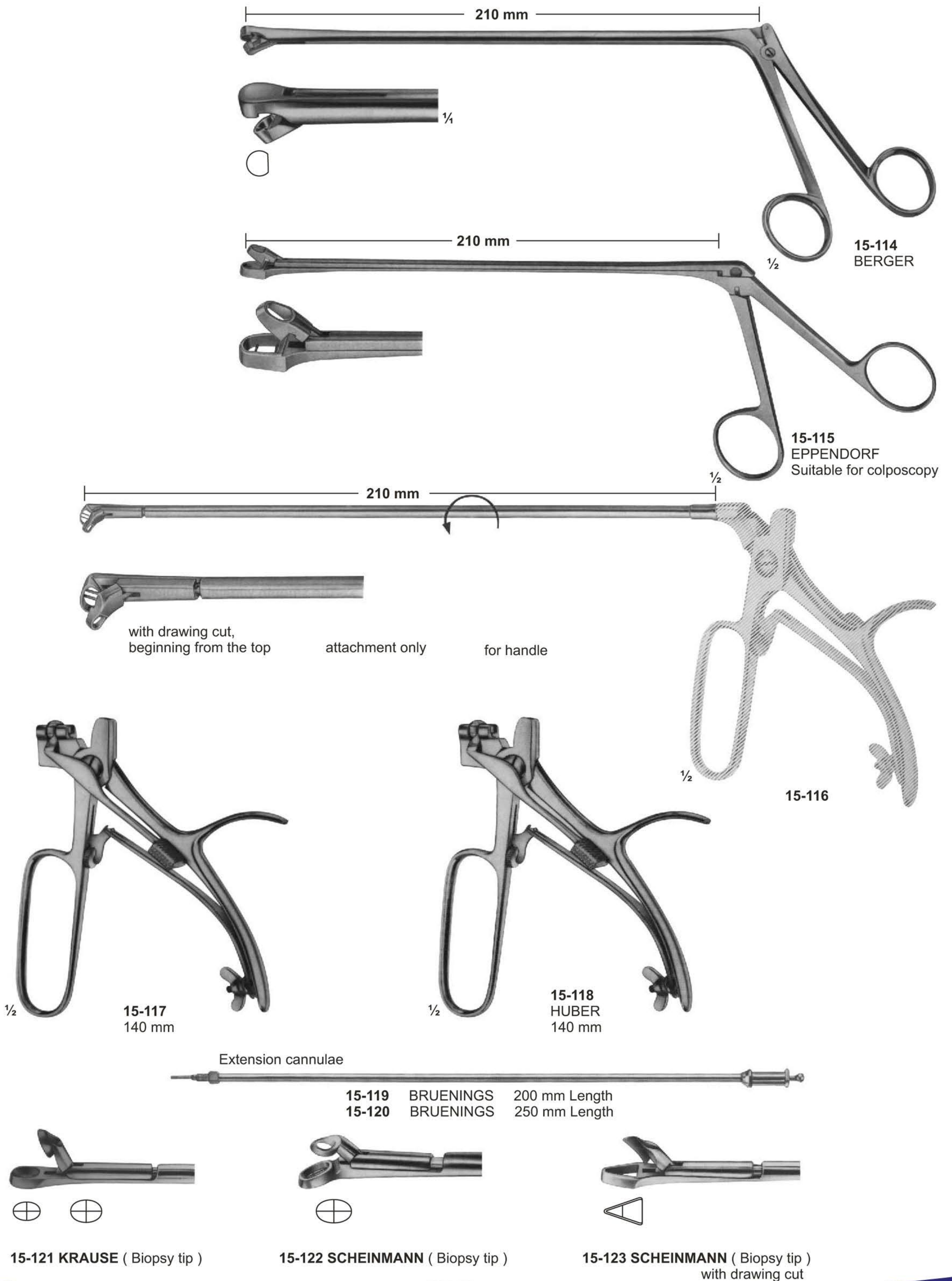



**Uterine Scoops**

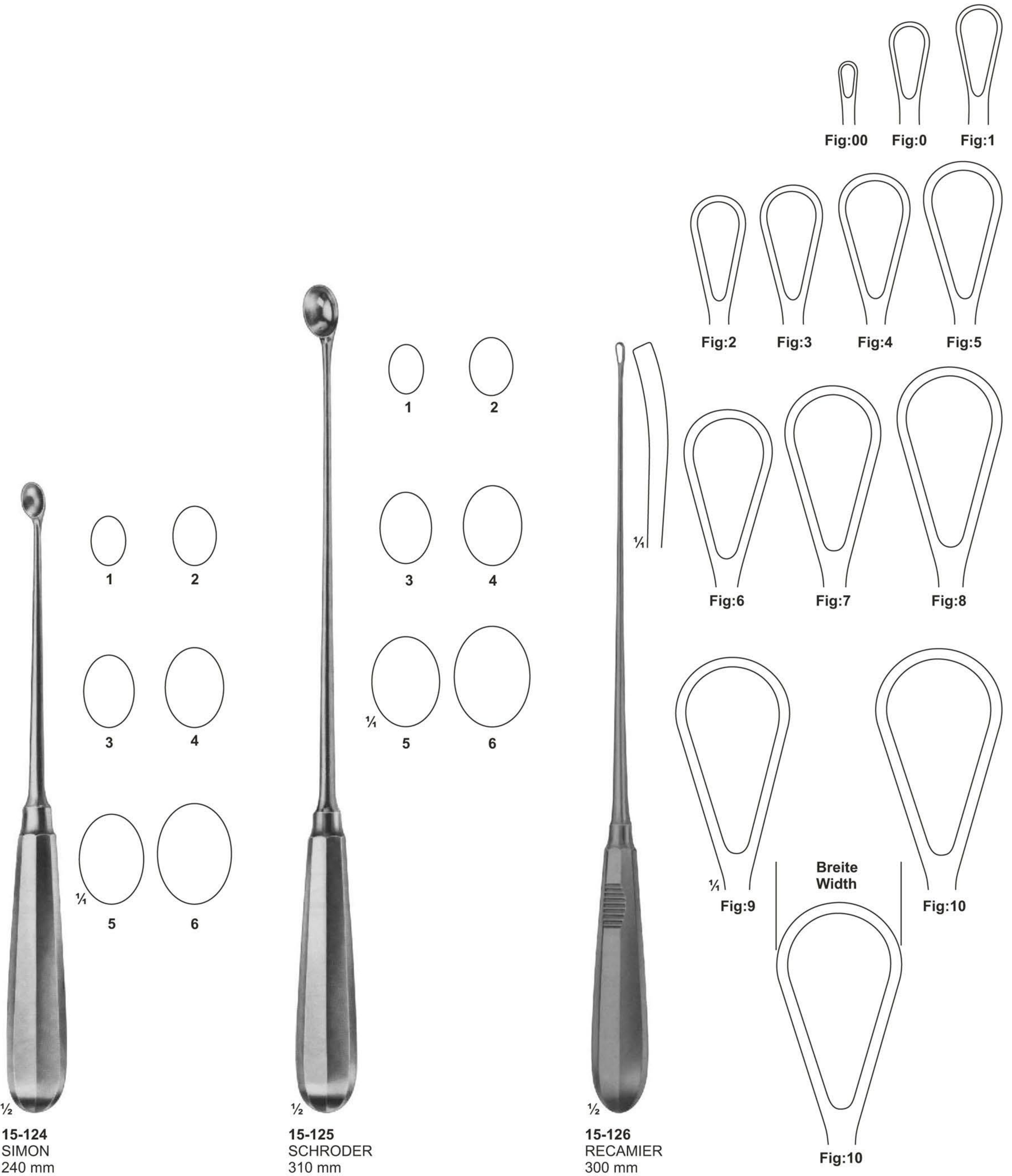

$\frac{1}{2}$   
**15-124**  
**SIMON**  
240 mm

$\frac{1}{2}$   
**15-125**  
**SCHRODER**  
310 mm

$\frac{1}{2}$   
**15-126**  
**RECAMIER**  
300 mm



# Uterine Curettes

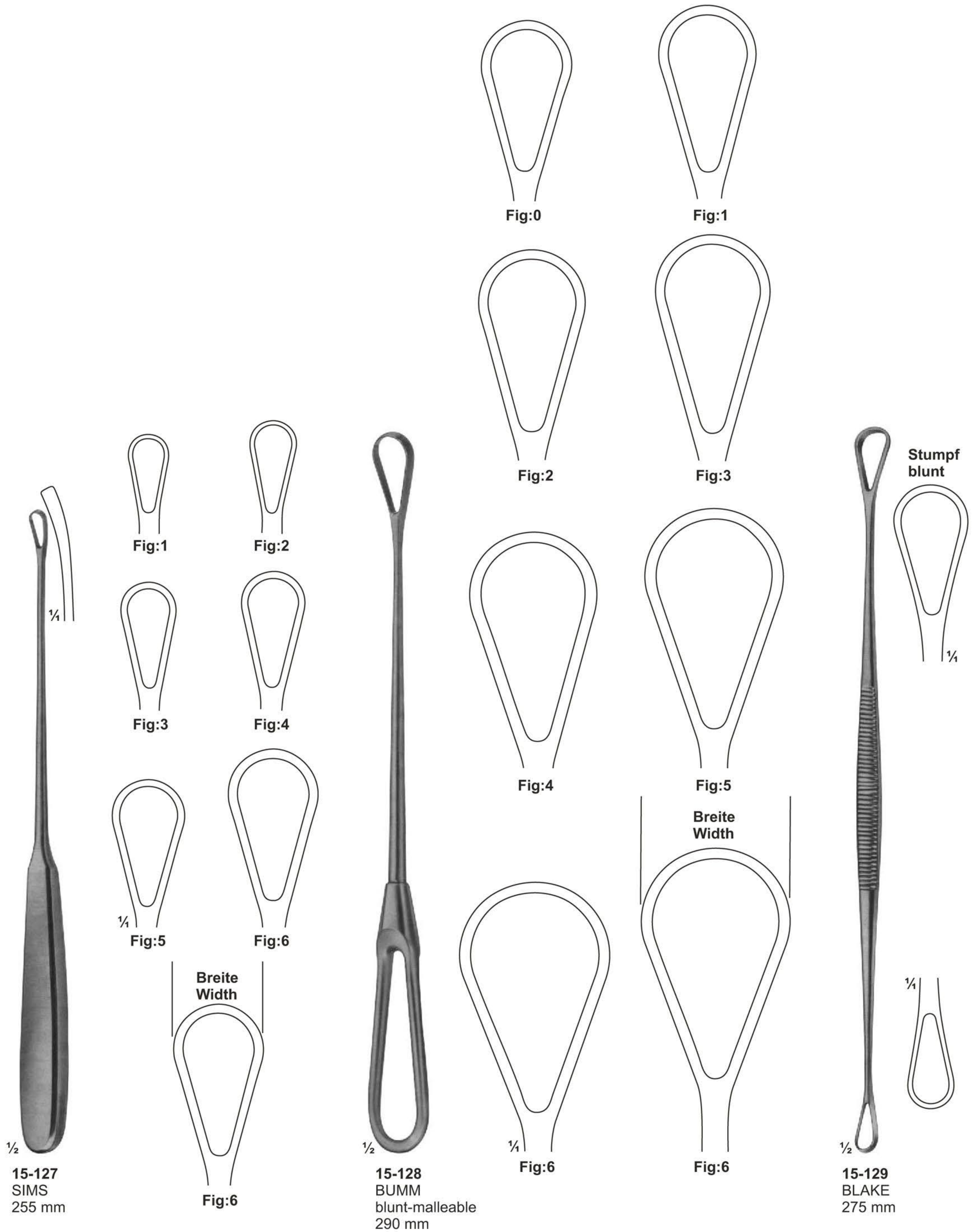



**Placenta-and Ovum Curettes**



$\frac{1}{2}$   
**15-130**  
COLLIN  
300 mm



$\frac{1}{2}$   
**15-131**  
RECAMIER  
blunt-rigid  
360 mm

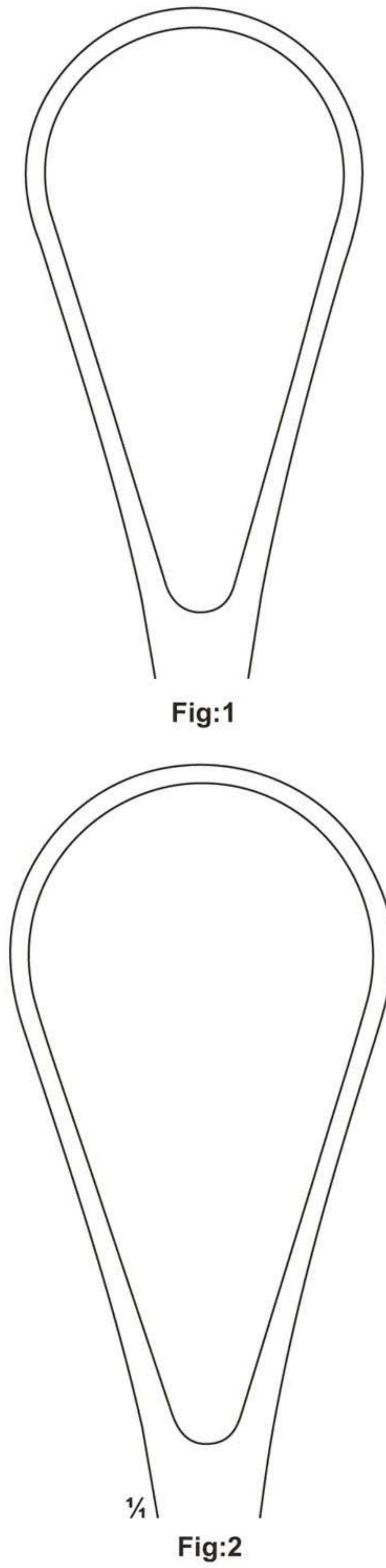
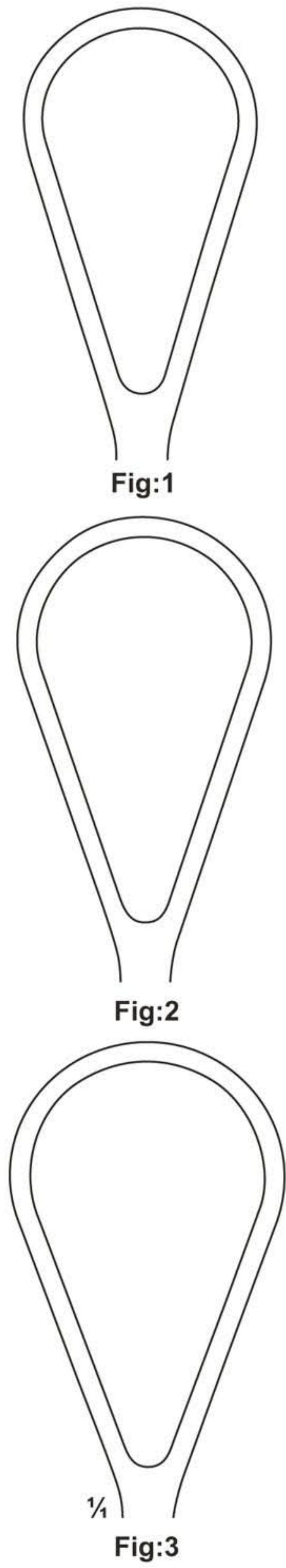

**Fig:1**

**Fig:2**



$\frac{1}{2}$   
**15-132**  
BUMM  
310 mm



**Fig:1**

**Fig:2**

**Fig:3**



# Vacuum Curettes

**15-133 - 138**

Suction curettes, stainless steel, fitting hose connection.

Working tips are smoothly rounded of, therefore no danger of perforation.



( suitable for suction biopsy )

- 15-133:** diam 4 mm
- 15-134:** diam 6 mm
- 15-135:** diam 8 mm
- 15-136:** diam 10 mm
- 15-137:** diam 12 mm
- 15-138:** diam 14 mm

**15-139**

Hose connection inside diam. 11 mm curved stainless steel.

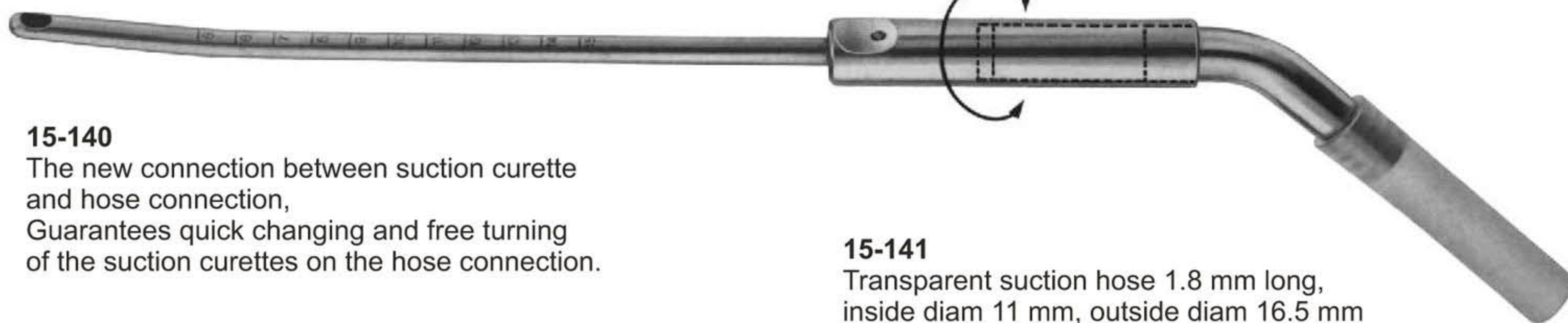

**15-140**

The new connection between suction curette and hose connection, Guarantees quick changing and free turning of the suction curettes on the hose connection.

**15-141**

Transparent suction hose 1.8 m long, inside diam 11 mm, outside diam 16.5 mm can be sterilized in an autoclave at 1 bar overpressure ( 120 C )

**15-142**

Strainer for tissues, plastic, for single use only, to be used for histopathological examination.





# Gynaecological Instruments



15-143 diam 8 mm  
15-144 diam 10 mm  
BOZEMANN-FRITSCH  
Uterine Flushing Tube  
350 mm

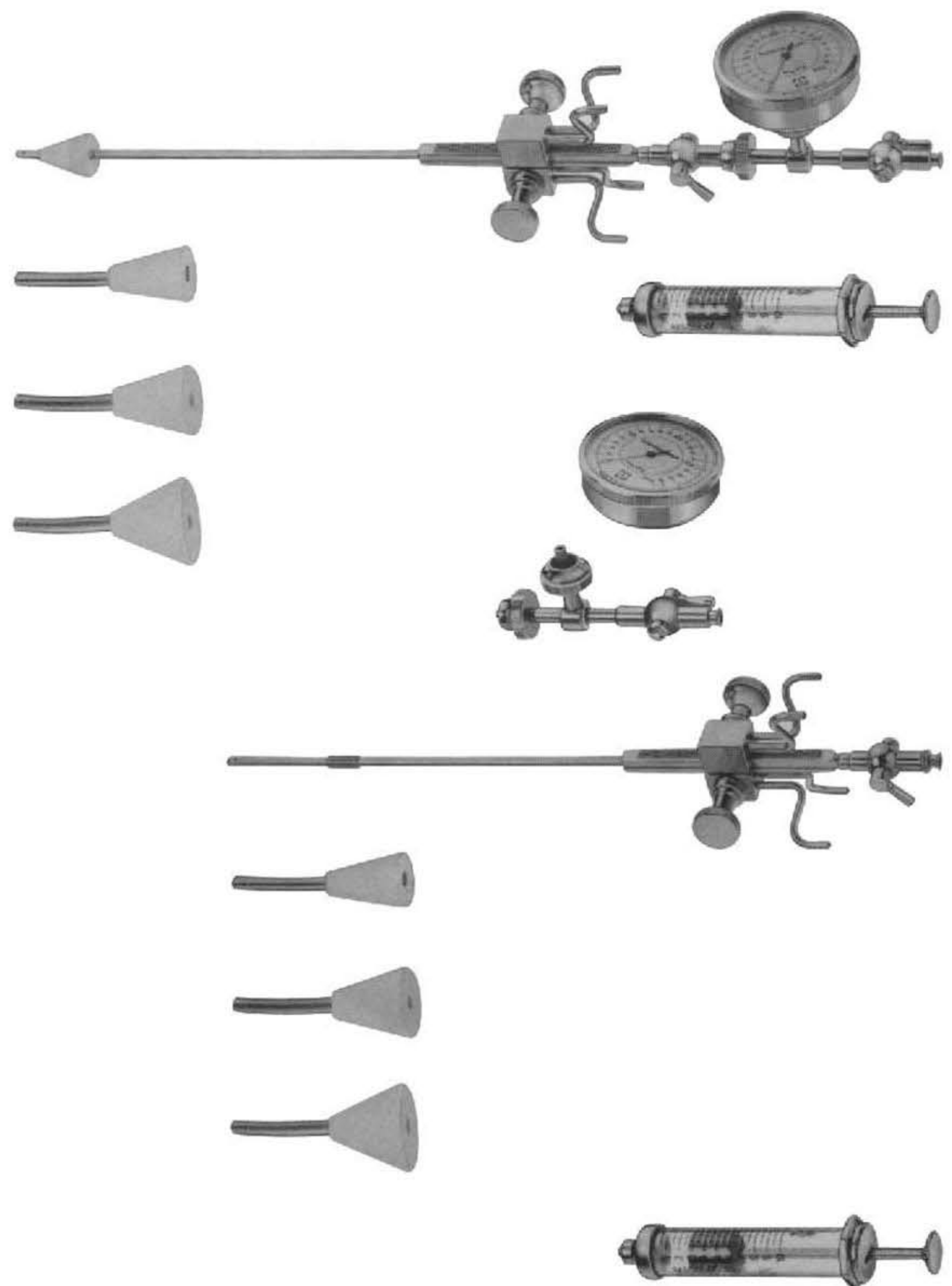

15-145  
SCHULZE  
Salpingograph, for utero-salpingography  
in wooden case, consisting of:  
Manometer, Connection, Uterine cannula  
with tap, Cone S.M.L,  
Record Syringe 10 cc, Luer lock mount.



15-146  
SCHULZE  
Salpingograph, equipment  
without manometer.



**Obstetrics-Pelvimeters**

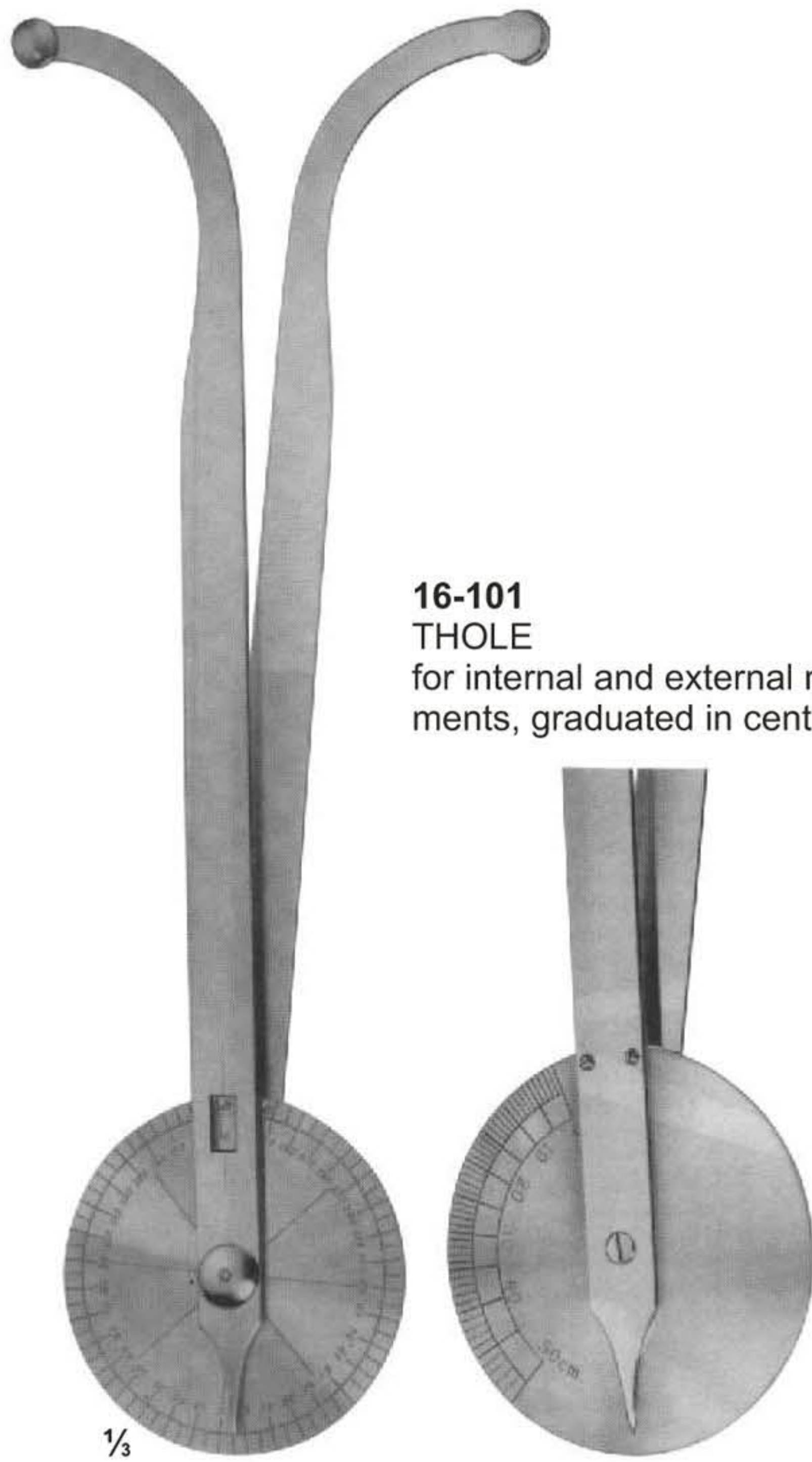

**16-101**  
**THOLE**  
for internal and external measurements, graduated in centimeters



**16-102**  
**DE LEE**  
graduated in centimeters and inches



**16-103**  
**COLLIN**  
graduated in centimeters



**16-104**  
**MARTIN**  
graduated in centimeters



for internal measurements between symphysis and promontory

**16-105**  
**COLLIN**  
graduated in centimeters

The additional straight arm can be replaced. The pelvimeter with straight arm is used for localisation of the portio vaginalis uteri and of vaginal metastasis.



**16-106**  
**BREISKY**  
graduated in centimeters



Obstetrics-Pelvimeters

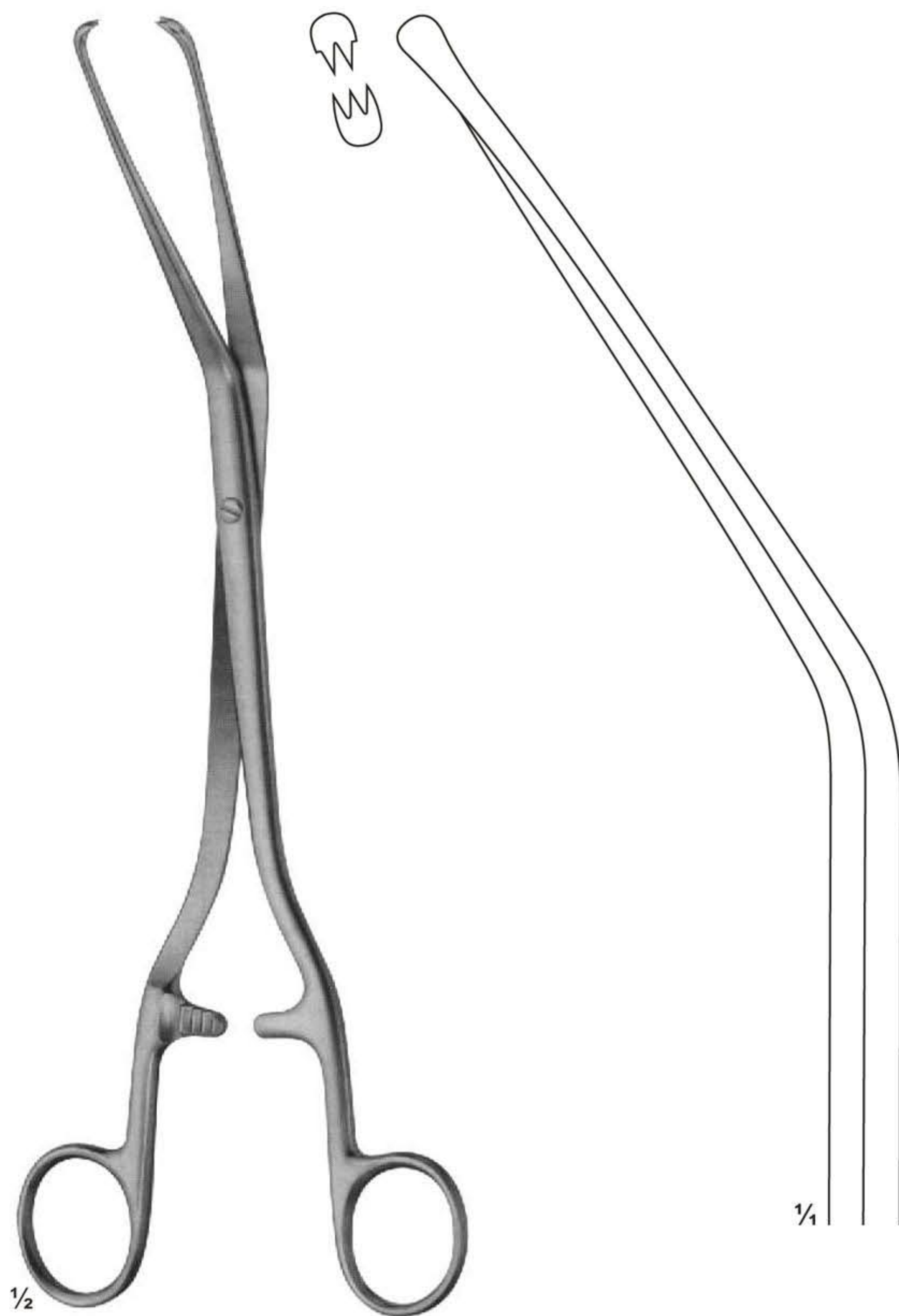

**16-107**  
HERFF  
puncturing forceps  
225 mm



**16-108**  
IOWA  
puncturing forceps  
260 mm



**Scissors of Obstetrics, Umbilical cord clamp**



**16-109**  
SCHUMACHER  
Umbilical cord  
scissors  
155 mm



**16-110**  
Umbilical cord  
scissors  
105 mm

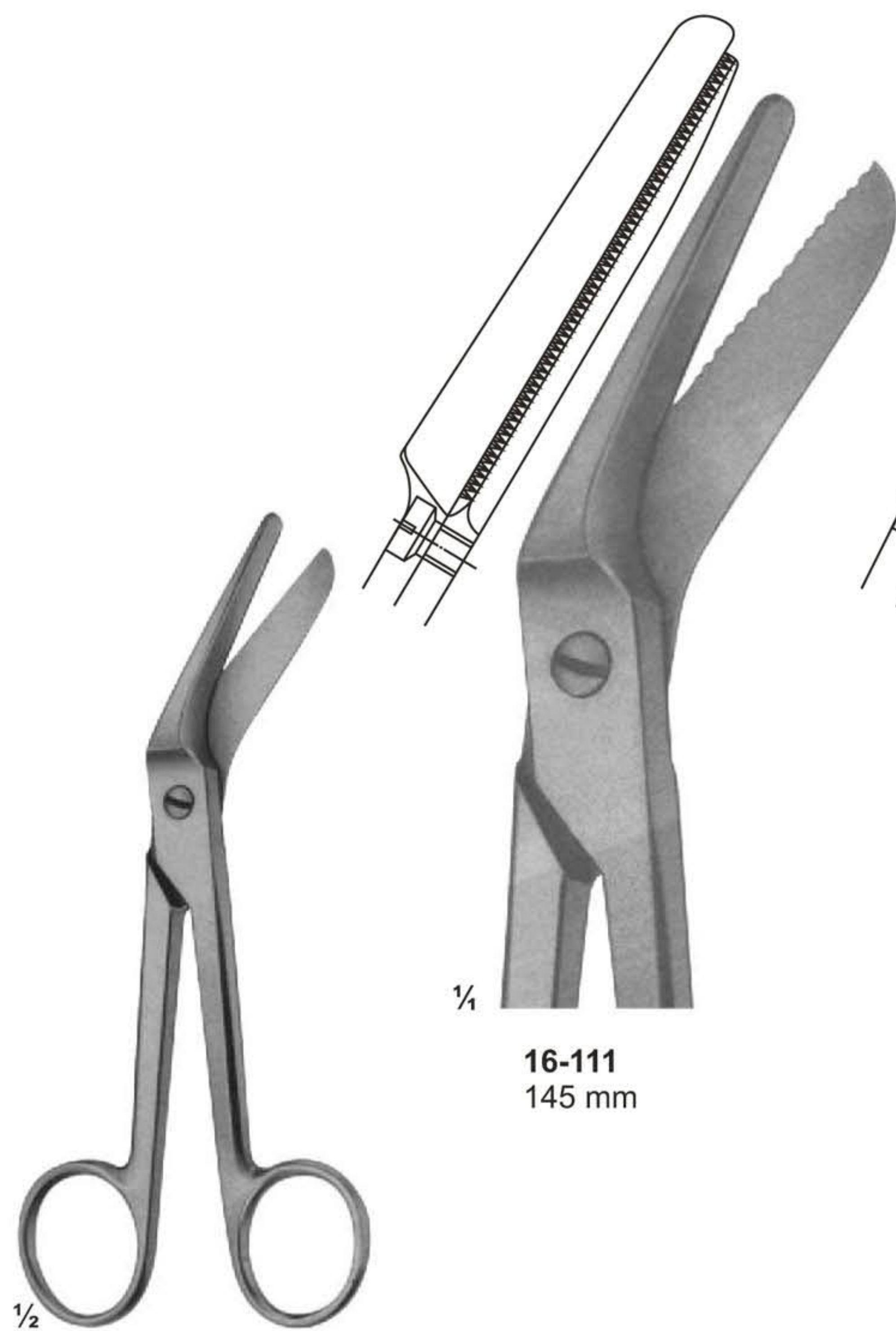

**16-111**  
145 mm

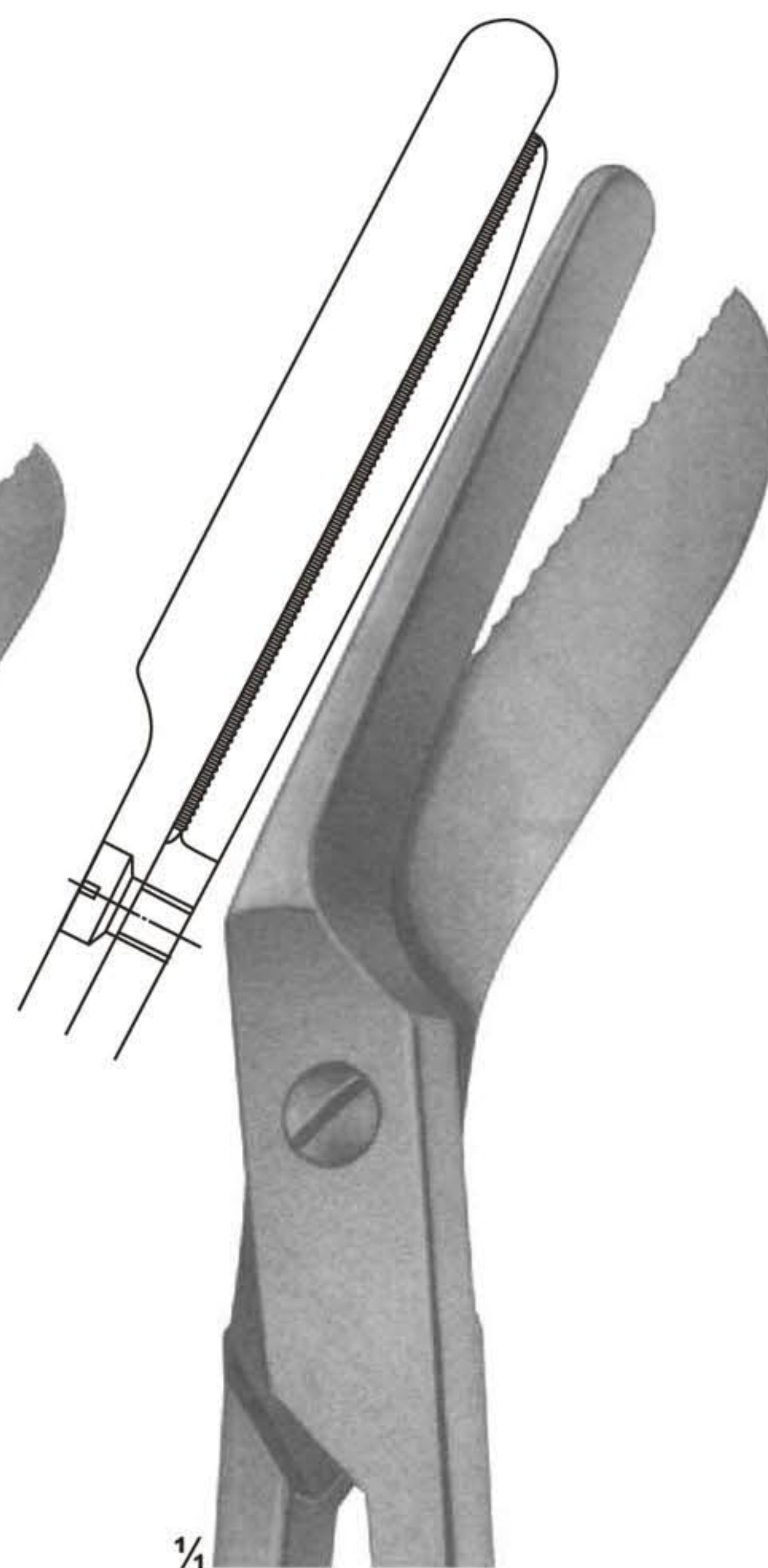

**16-112**  
200 mm

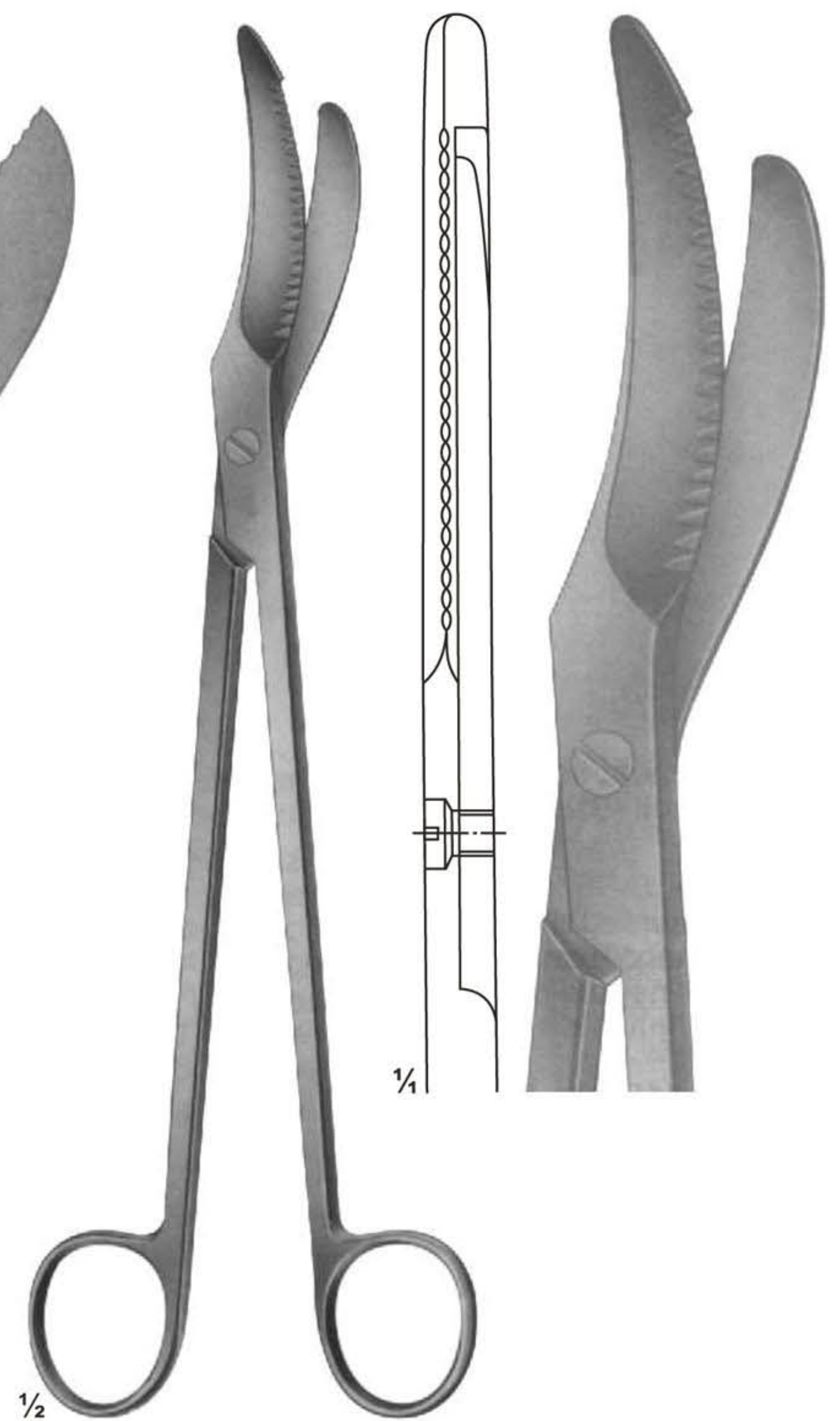

**16-113**  
Episiotomy Scissors  
240 mm



# Obstetrics Forceps

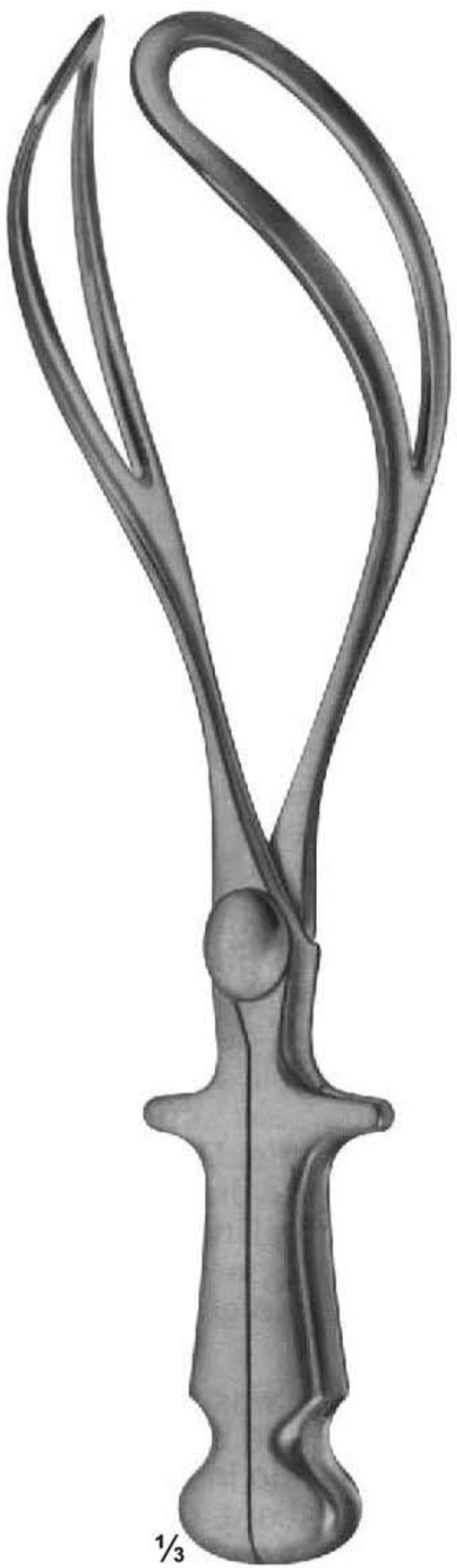

1/3

**16-114**  
355 mm

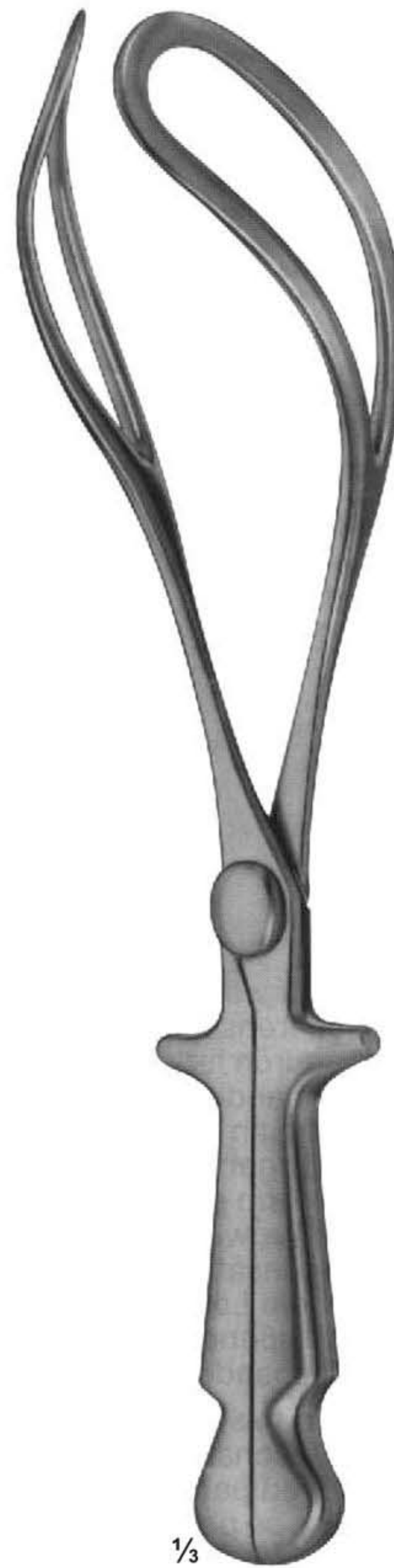

1/3

**16-115**  
400 mm



1/3

**16-116**  
SIMPSON-BRAUN  
305mm



## Obstetrics Forceps



**16-117**  
SIMPSON-BRAUN  
305mm



**16-118**  
SIMPSON  
235mm

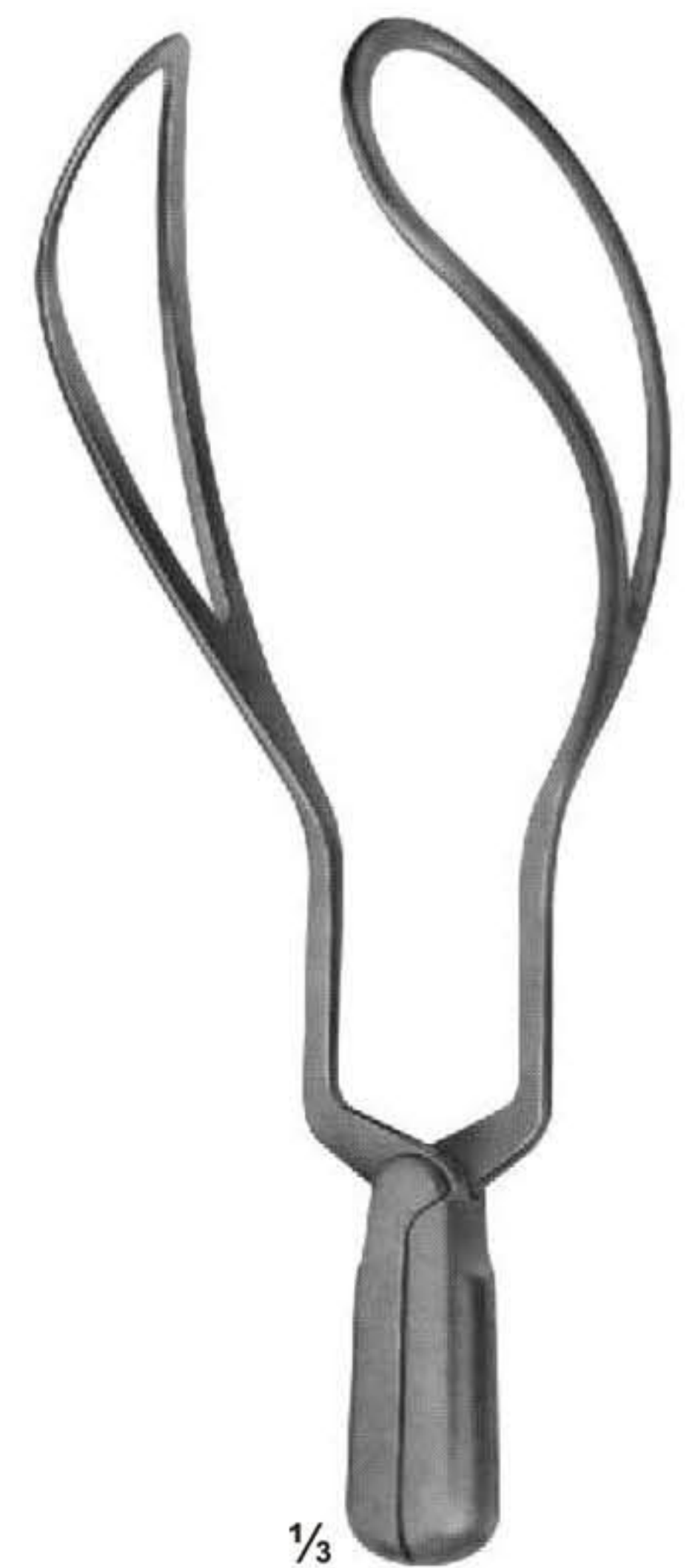

**16-119**  
WRIGLEY  
250 mm



**Obstetrics Forceps**

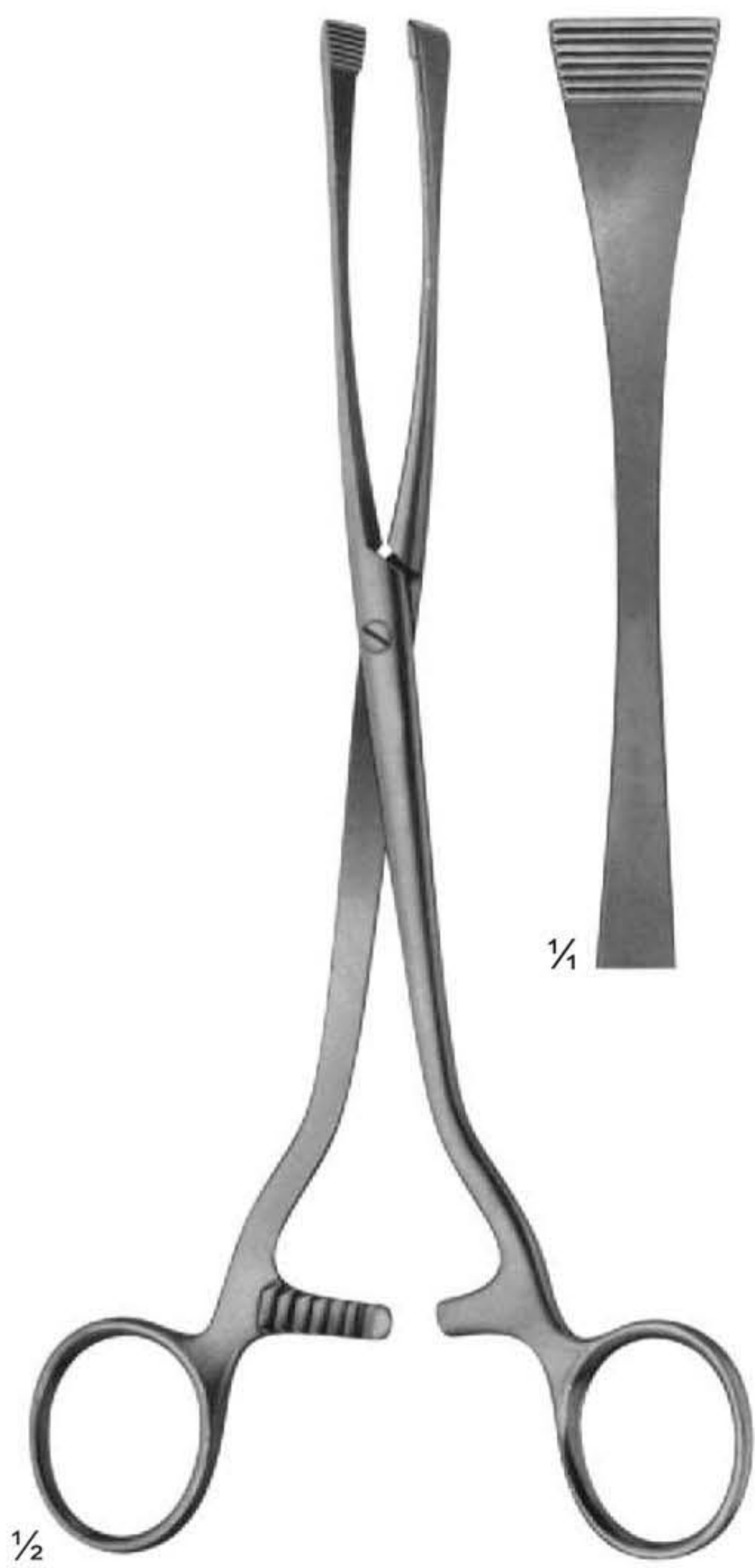

**16-120**  
**GREEN-ARMYTAGE**  
Caesarean section haemostatic  
forceps, for edges of the transverse  
incision in the lower segment  
220 mm



**16-121**  
**WILLETT**  
Scalpel Flap forceps  
185 mm

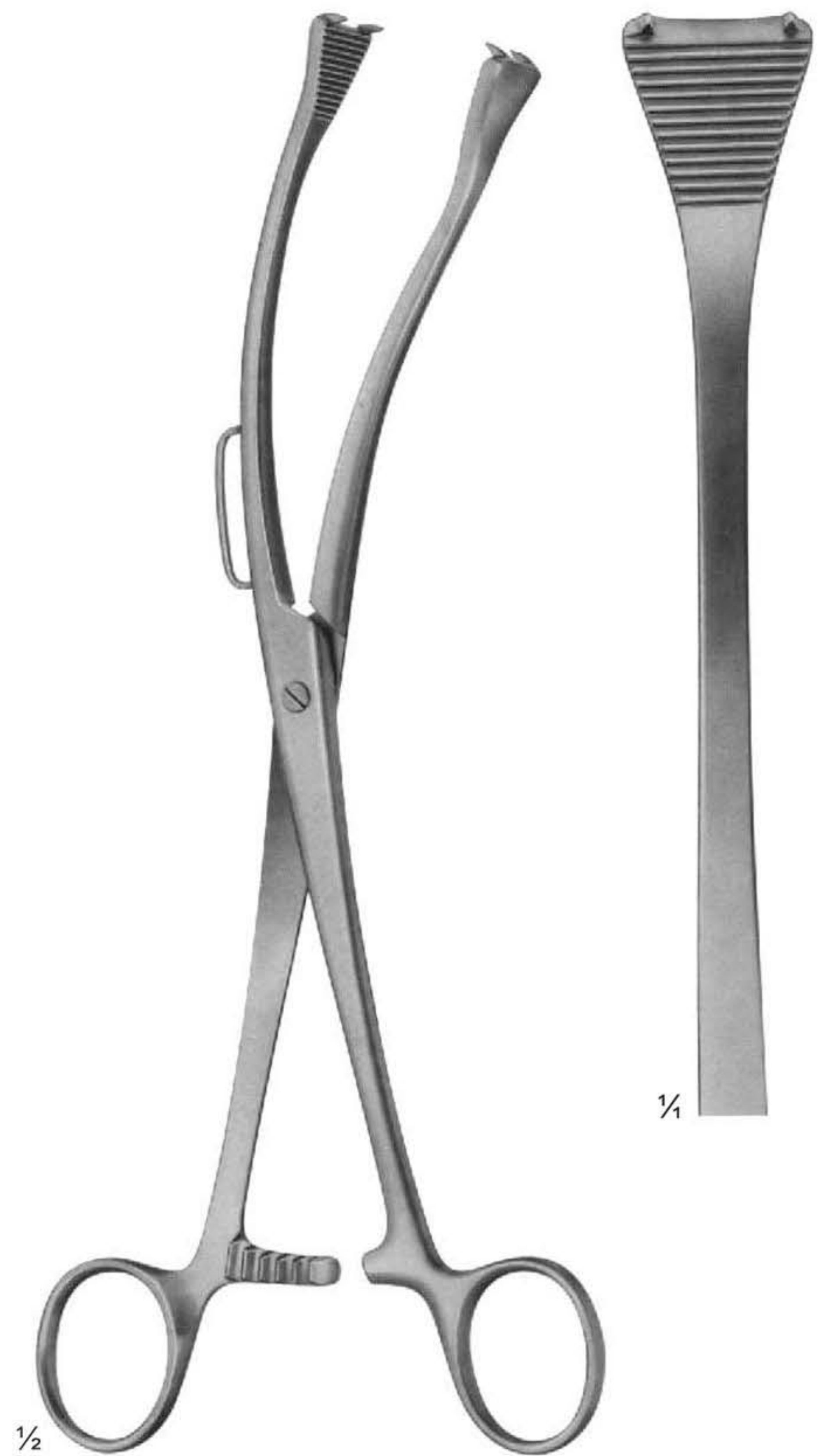

**16-122**  
**GAUSS**  
Scalpel Flap forceps  
260 mm



Obstetrics-Placenta and Ovum Forceps

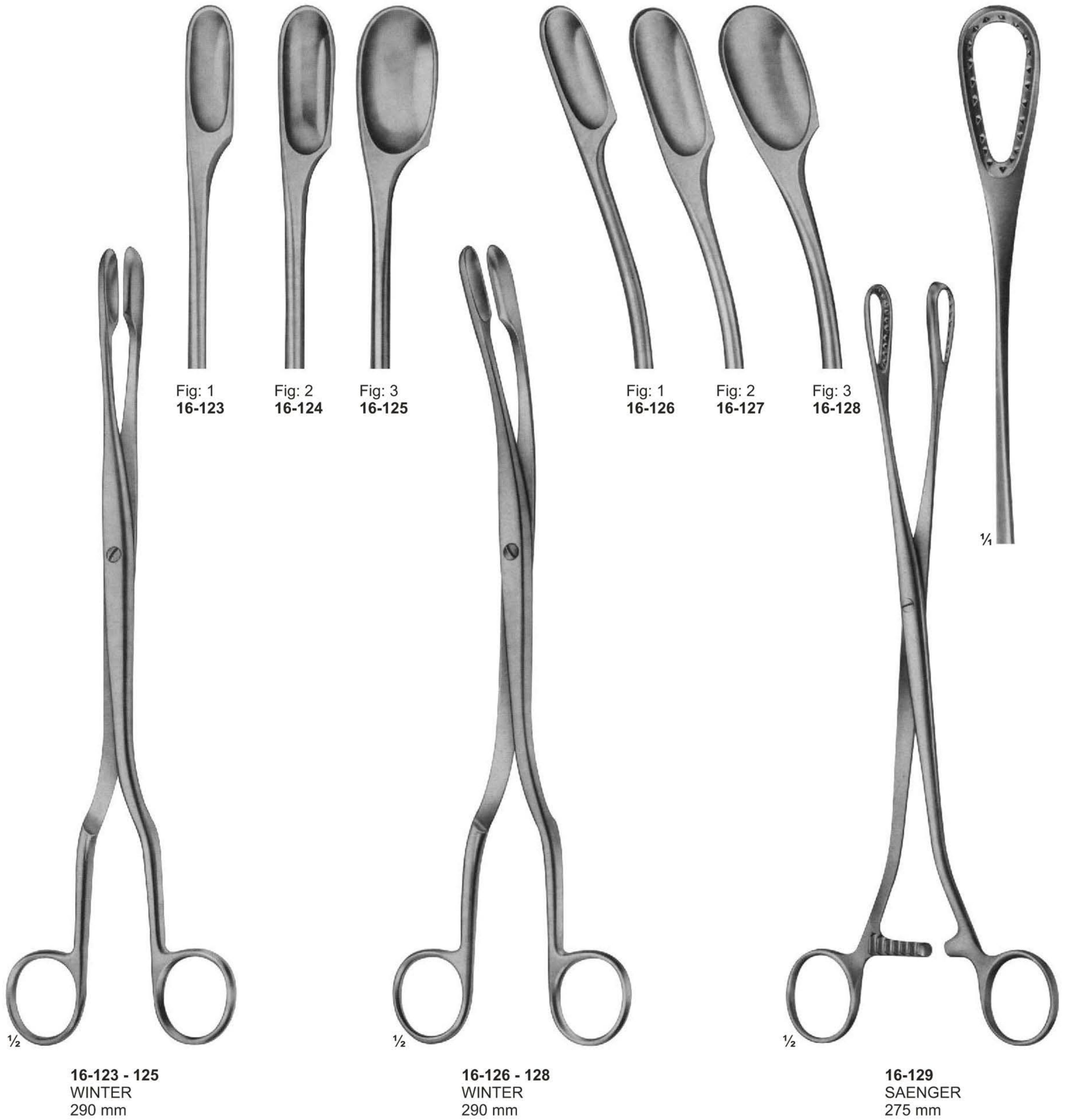



**Obstetrics-Placenta and Ovum Forceps**

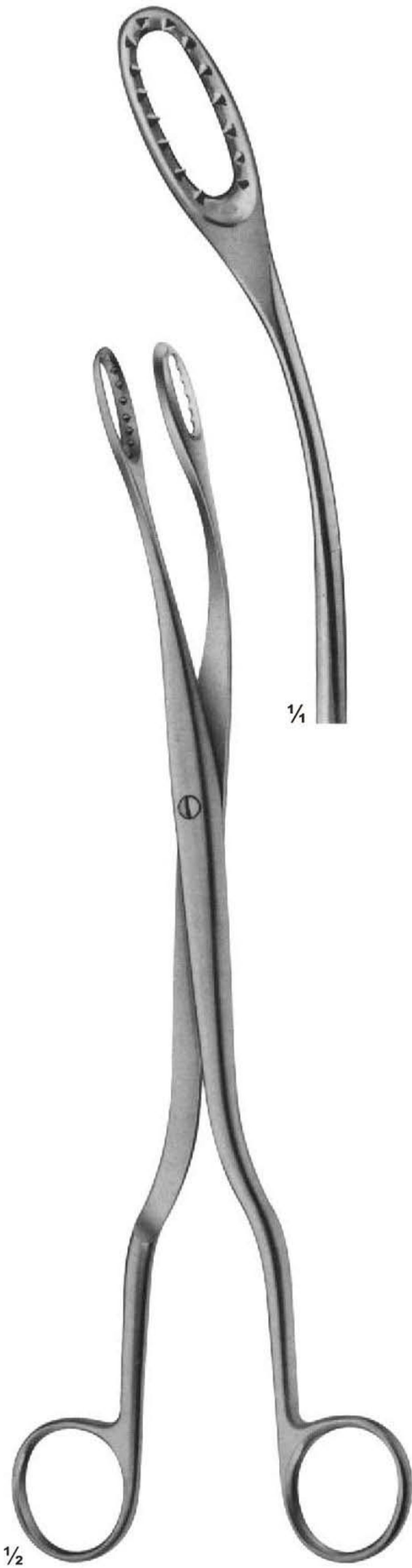

**16-130**  
SAENGER  
285 mm

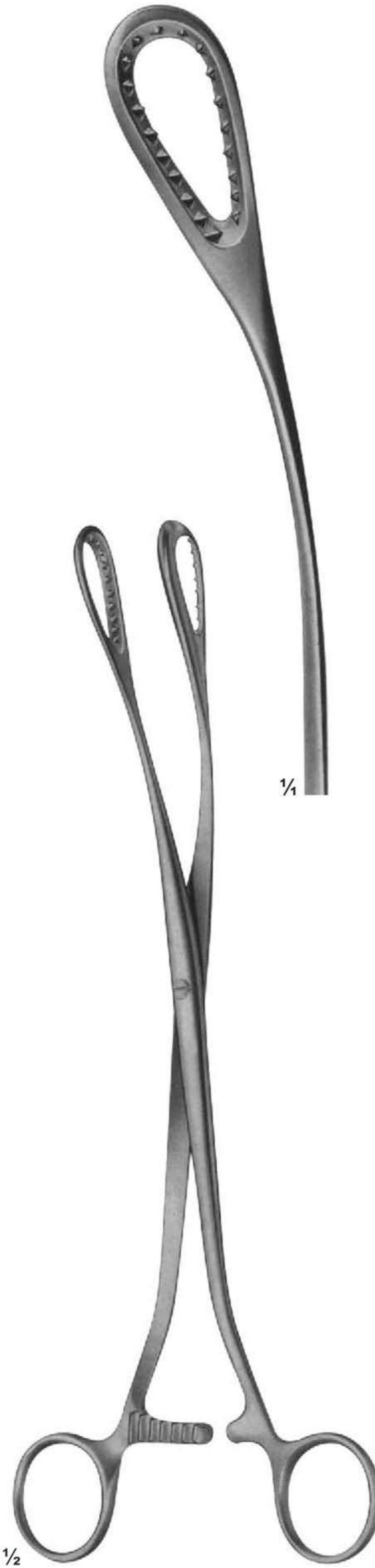

**16-131**  
SAENGER  
285 mm



**16-132 - 133**  
LEWKOWIZ  
245 mm



## Obstetrics-Placenta, Ovum and Cranioclast, Basiotribe Forceps

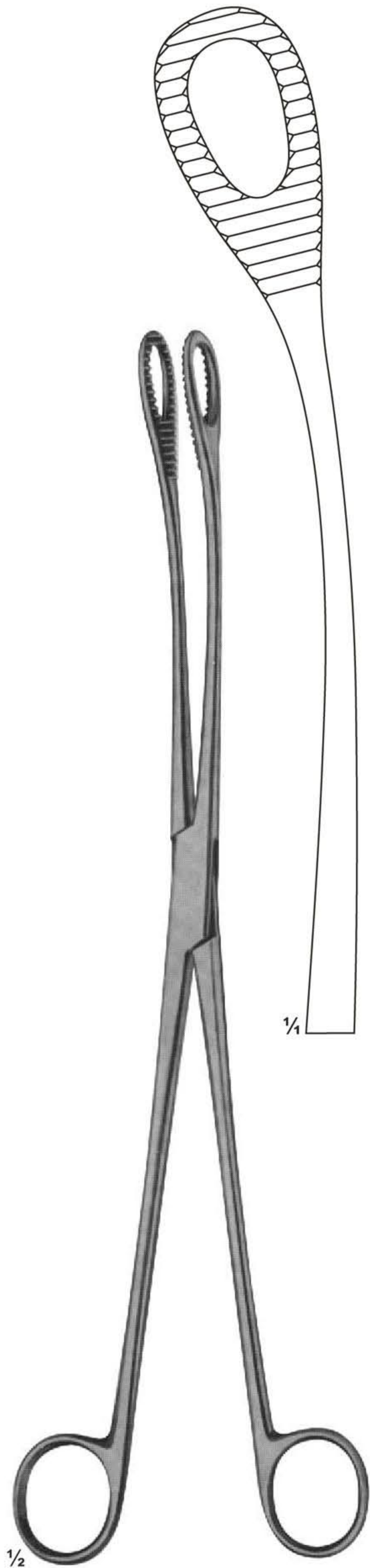

**16-134**  
KELLY  
320mm



**16-135**  
SMELLIE  
Perforator  
270mm



**16-136**  
BRAUN  
Cranioclast  
420mm



**Tracheal Tubes with inner tubes**



1/2

**16-137**  
UECKERMANN-DENKER  
Cryothyrotomy trocar  
with silver cannula  
130mm

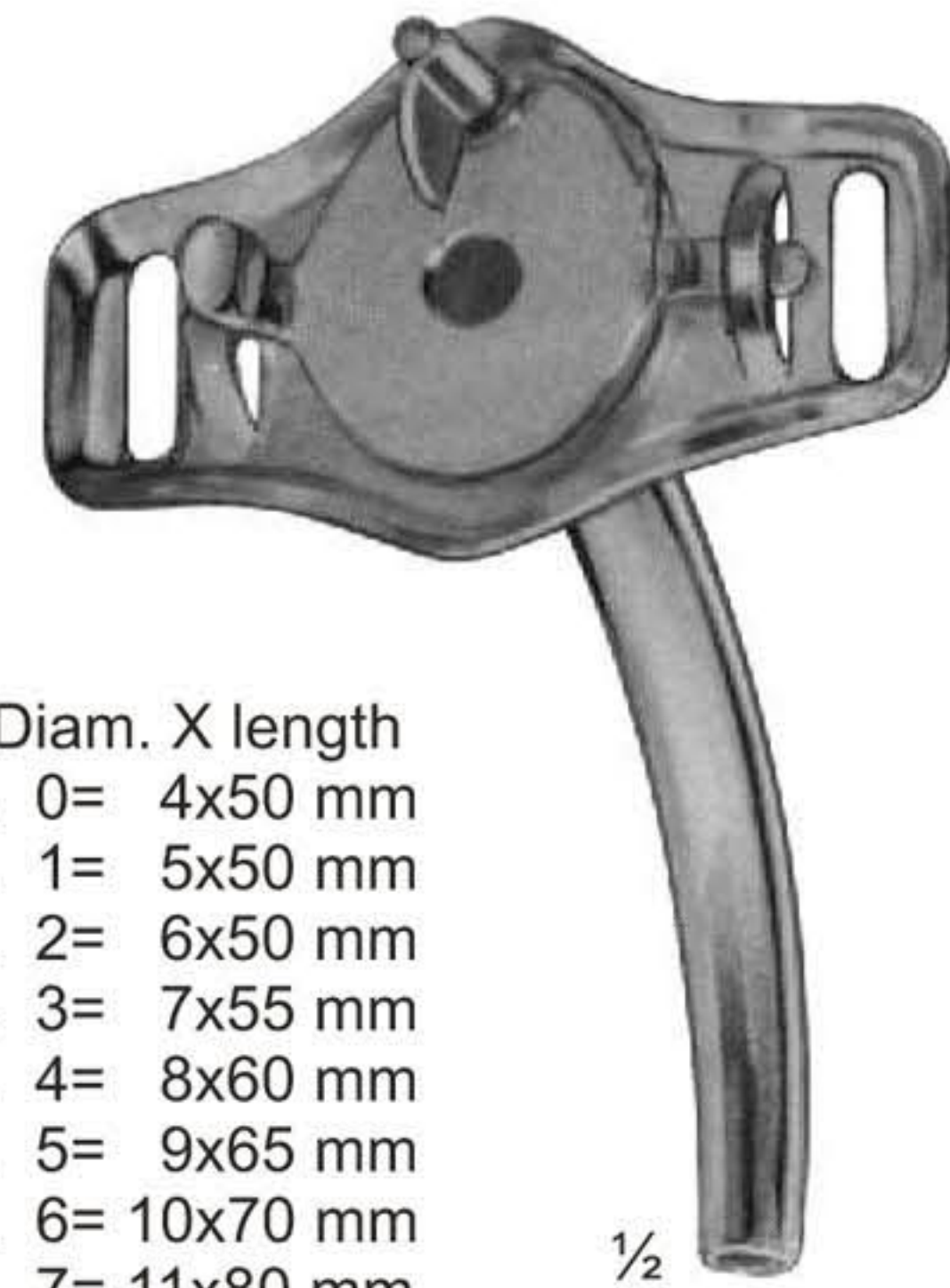

1/2

**16-138 - 148**  
LUER  
German silver

- Diam. X length
- 16-138** Fig. 0= 4x50 mm
  - 16-139** Fig. 1= 5x50 mm
  - 16-140** Fig. 2= 6x50 mm
  - 16-141** Fig. 3= 7x55 mm
  - 16-142** Fig. 4= 8x60 mm
  - 16-143** Fig. 5= 9x65 mm
  - 16-144** Fig. 6= 10x70 mm
  - 16-145** Fig. 7= 11x80 mm
  - 16-146** Fig. 8= 12x85 mm
  - 16-147** Fig. 9= 13x90 mm
  - 16-148** Fig. 10=14x90 mm



1/2

**16-149 - 158**  
JACKSON  
German Silver

- Diam. X length
- 16-149** Fig. 0= 4x50 mm
  - 16-150** Fig. 1= 5x58 mm
  - 16-151** Fig. 2= 6x58 mm
  - 16-152** Fig. 3= 7x70 mm
  - 16-153** Fig. 4= 8x78 mm
  - 16-154** Fig. 5= 9x84 mm
  - 16-155** Fig. 6= 10x84 mm
  - 16-156** Fig. 7= 11x86 mm
  - 16-157** Fig. 8= 12x88 mm
  - 16-158** Fig. 9= 13x90 mm



1/2

- Diam. X length
- 16-159** Fig. 1= 5x48 mm
  - 16-160** Fig. 2= 6x58 mm
  - 16-161** Fig. 3= 7x70 mm
  - 16-162** Fig. 4= 8x78 mm
  - 16-163** Fig. 5= 9x84 mm
  - 16-164** Fig. 6= 10x84 mm
  - 16-165** Fig. 7= 11x86 mm
  - 16-166** Fig. 8= 12x88 mm
  - 16-167** Fig. 9= 13x90 mm
  - 16-168** Fig.10= 14x90 mm
- 16-159 - 168**  
JACKSON  
German Silver



# Tongue and Tracheal Hooks and Dilators

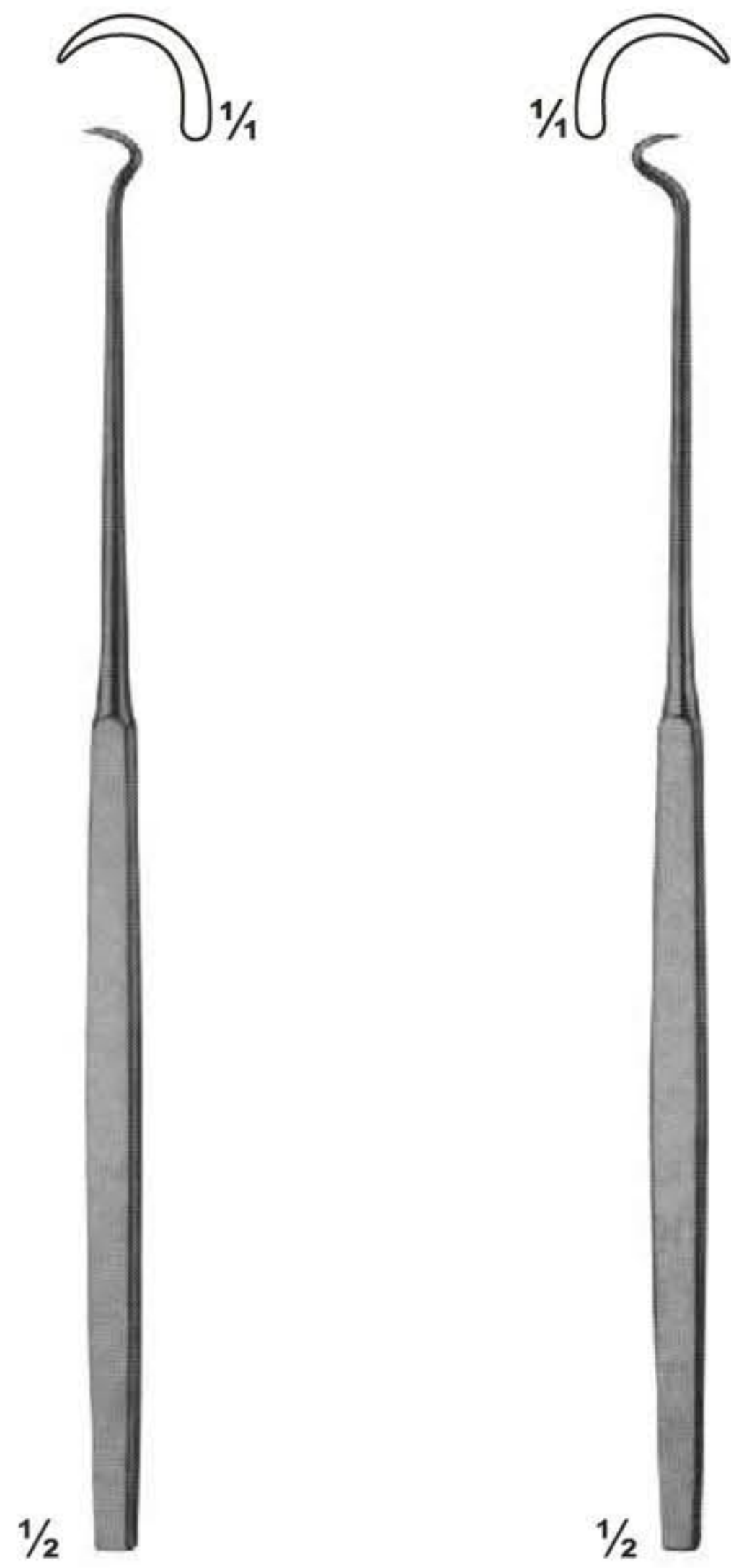

**16-169**  
BOSE  
165 mm

**16-170**  
BOSE  
165 mm

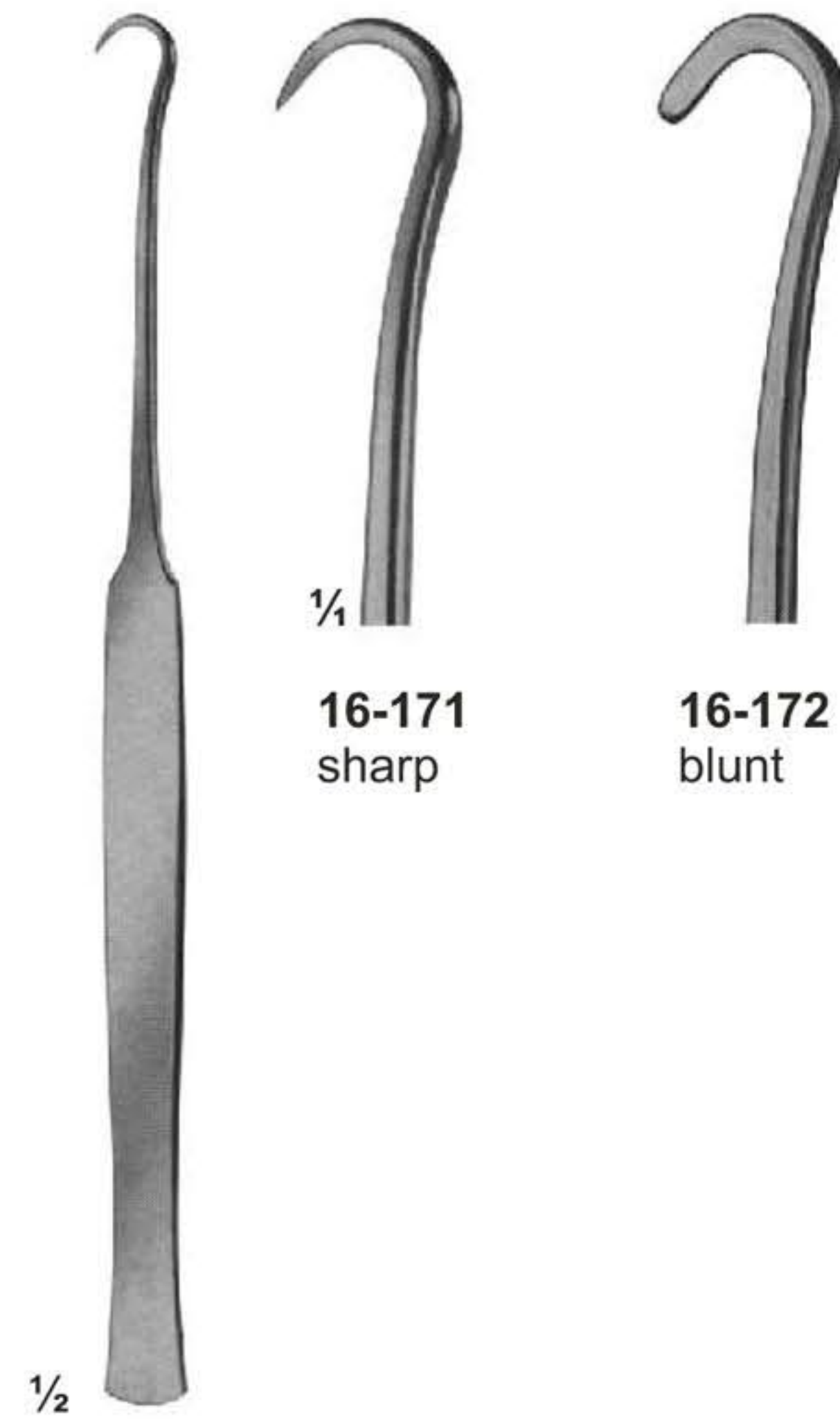

**16-171 - 173**  
180 mm

**16-171**  
sharp

**16-172**  
blunt

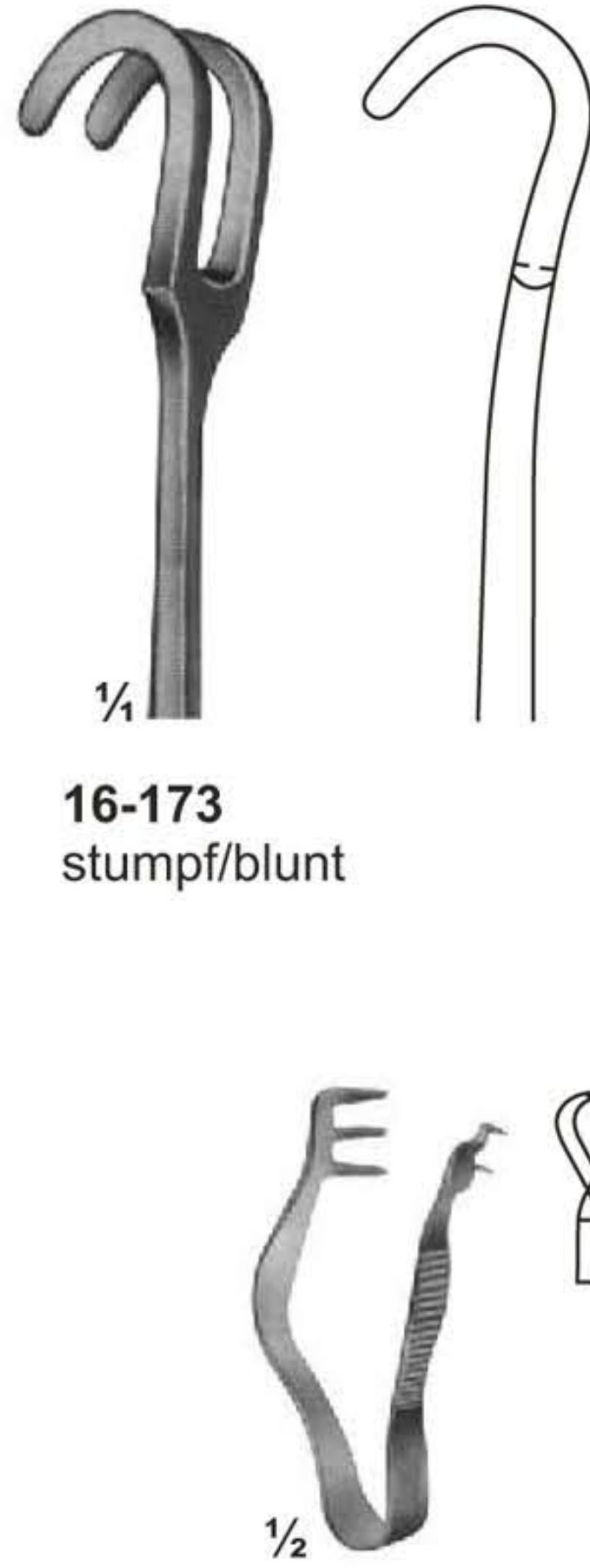

**16-173**  
stumpf/blunt

**16-174**  
FINSEN  
50 mm

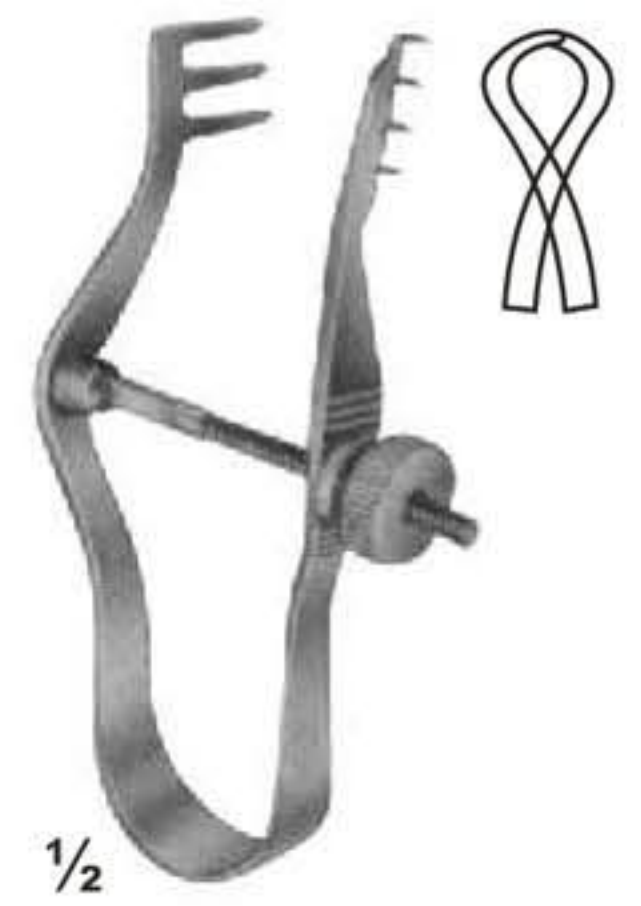

**16-175**  
FINSEN  
70 mm



**16-176**  
TROUSSEAU  
120 mm



**16-177**  
LABORDE  
125 mm

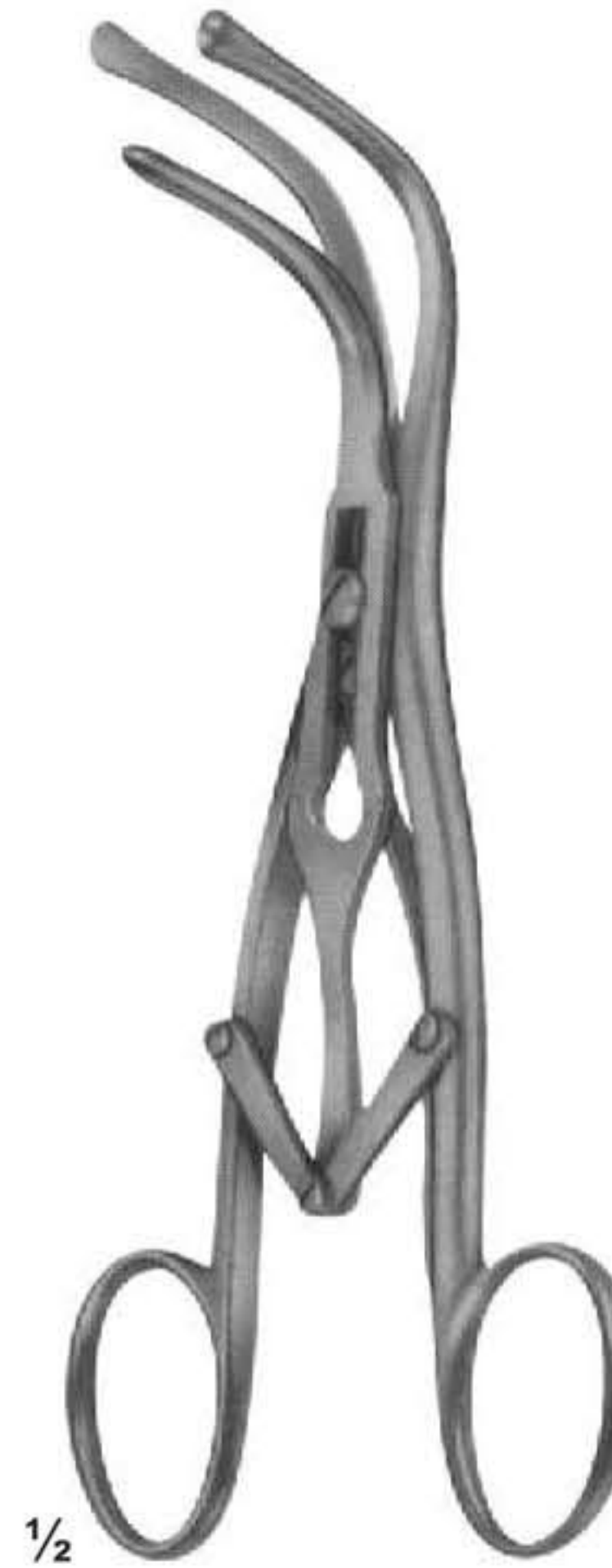

**16-178**  
LABORDE  
strong pattern  
135 mm



**16-179**  
Cleaning Brush  
for tracheal tubes  
285 mm



# Irrigating Cannulae, Embolus Grasping Forceps, Dilators

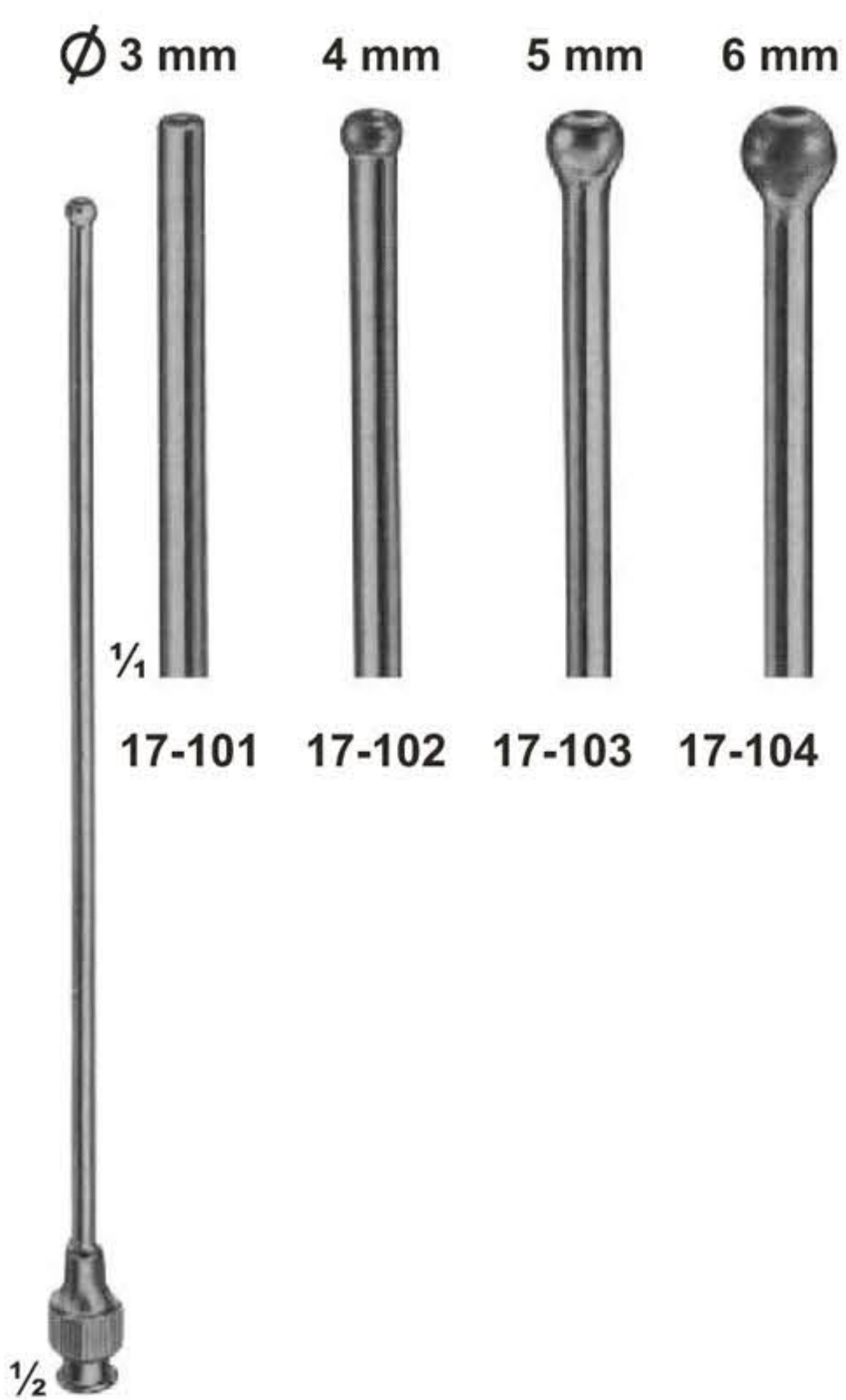

**17-101 - 104**  
SCHMID  
Vessel irrigating cannulae,  
malleable, silver plated  
150 mm

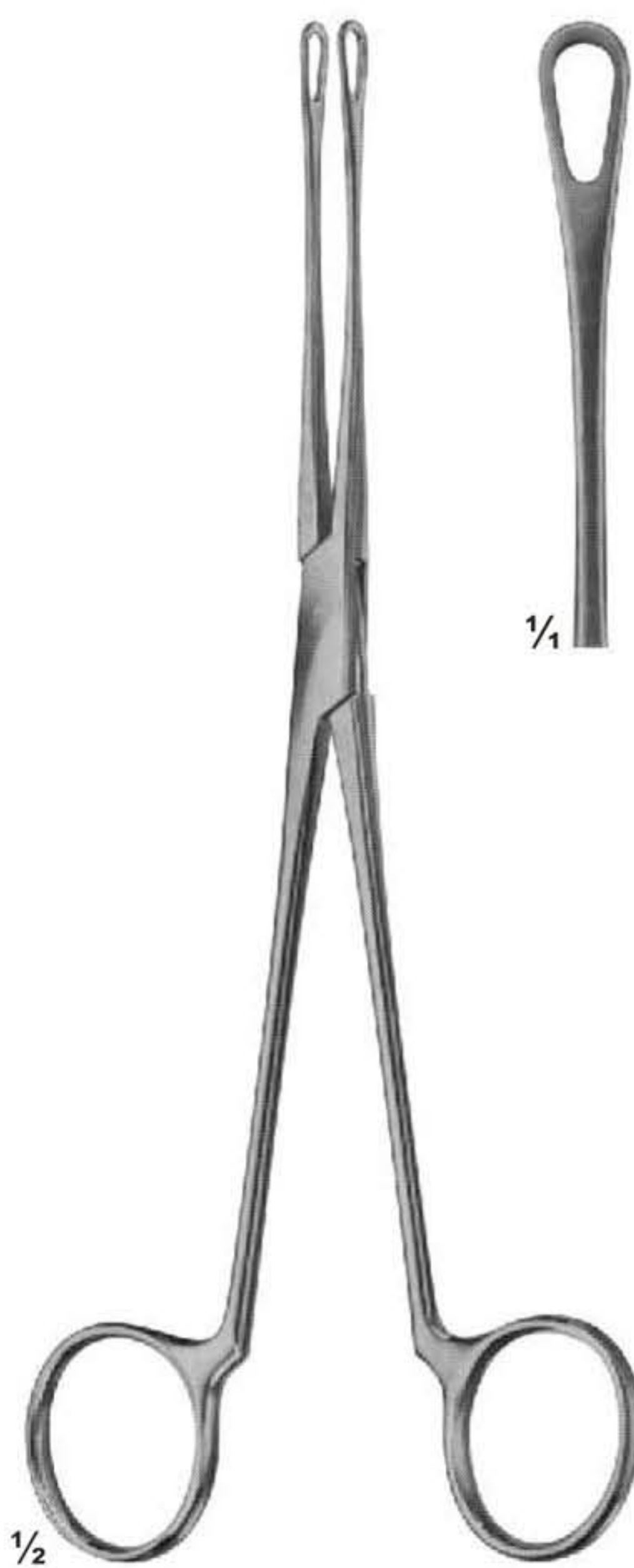

**17-105**  
BLAKE  
Embolus grasping  
forceps  
205 mm

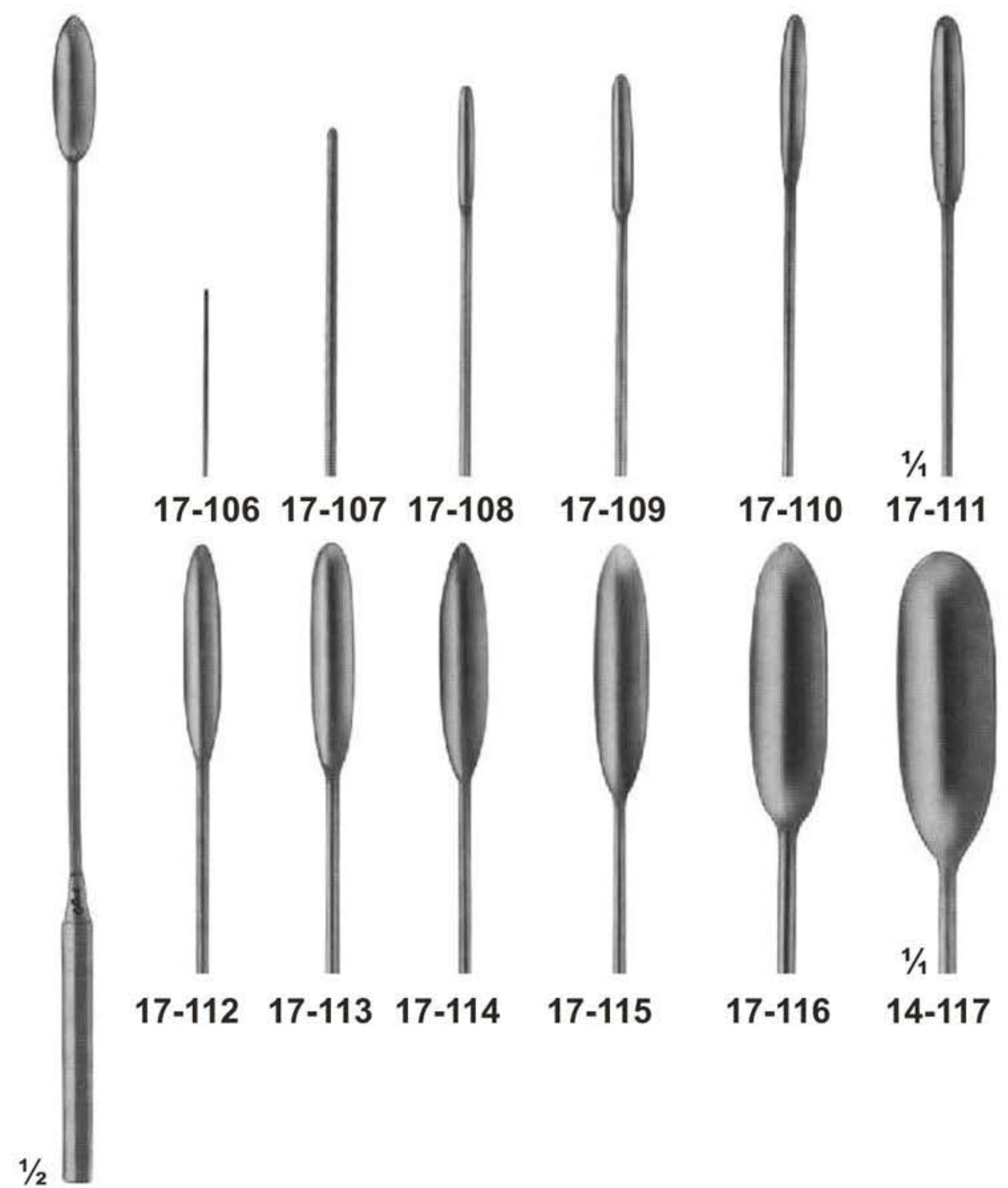

**17-106 - 117**  
DE BAKEY  
Vascular dilators,  
malleable  
190 mm

<b>17-106</b> 0,5 mm Ø	<b>17-112</b> 3,5 mm Ø
<b>17-107</b> 1,0 mm Ø	<b>17-113</b> 4,0 mm Ø
<b>17-108</b> 1,5 mm Ø	<b>17-114</b> 4,5 mm Ø
<b>17-109</b> 2,0 mm Ø	<b>17-115</b> 5,0 mm Ø
<b>17-110</b> 2,5 mm Ø	<b>17-116</b> 7,0 mm Ø
<b>17-111</b> 3,0 mm Ø	<b>17-117</b> 9,0 mm Ø



Irrigating Cannulae, Embolus Grasping Forceps, Dilators

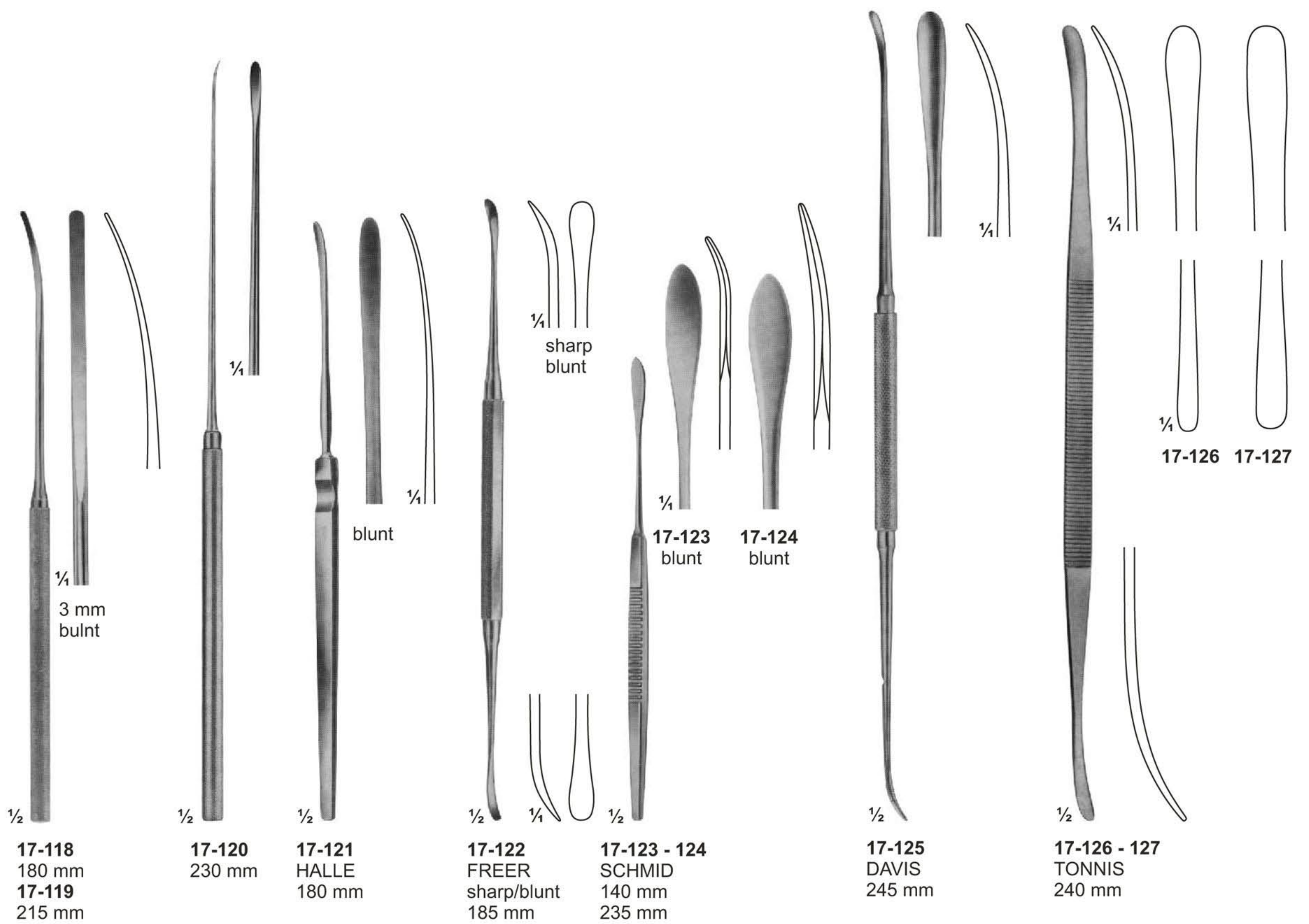



Irrigating Cannulae, Embolus Grasping Forceps, Dilators

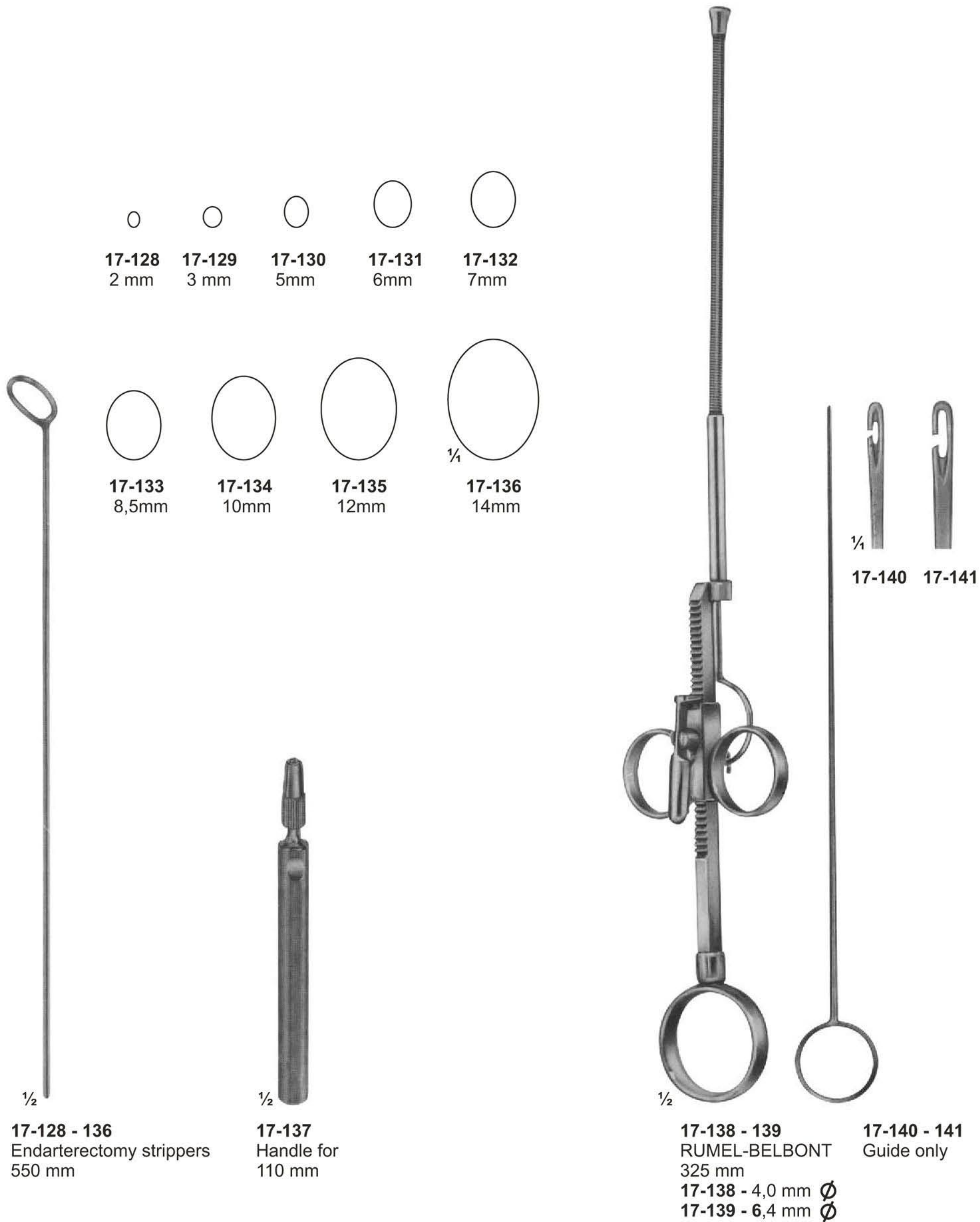



# Biopotome and Aortic Dilators

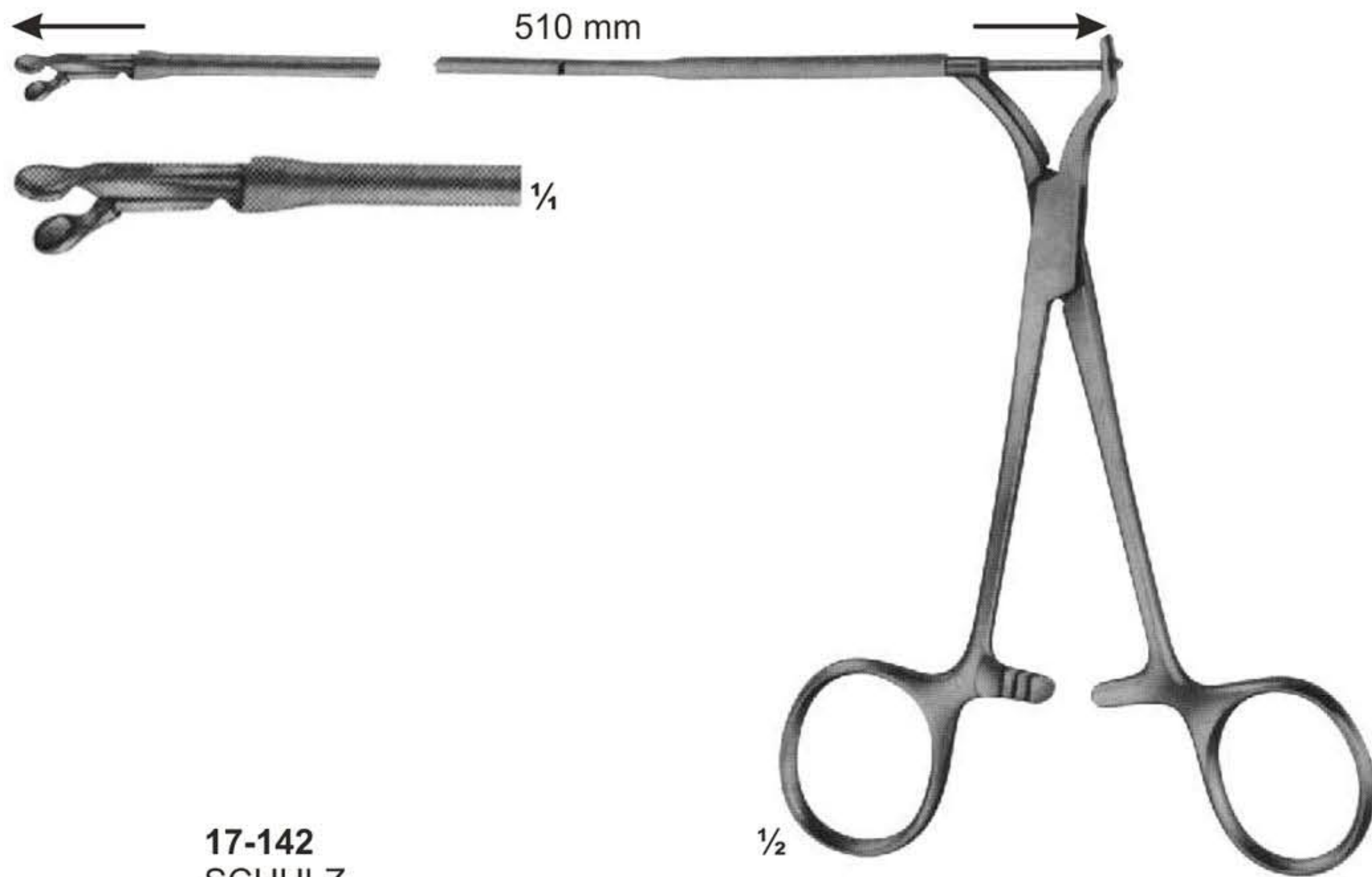

**17-142**  
**SCHULZ**  
Biopotome, mit flexiblem Schaft, 510 mm lang,  
with round jaws 3 mm diam.

Biopsy forceps, for biopsy from the right atrium  
through cava juglaris, prior to heart implantations.

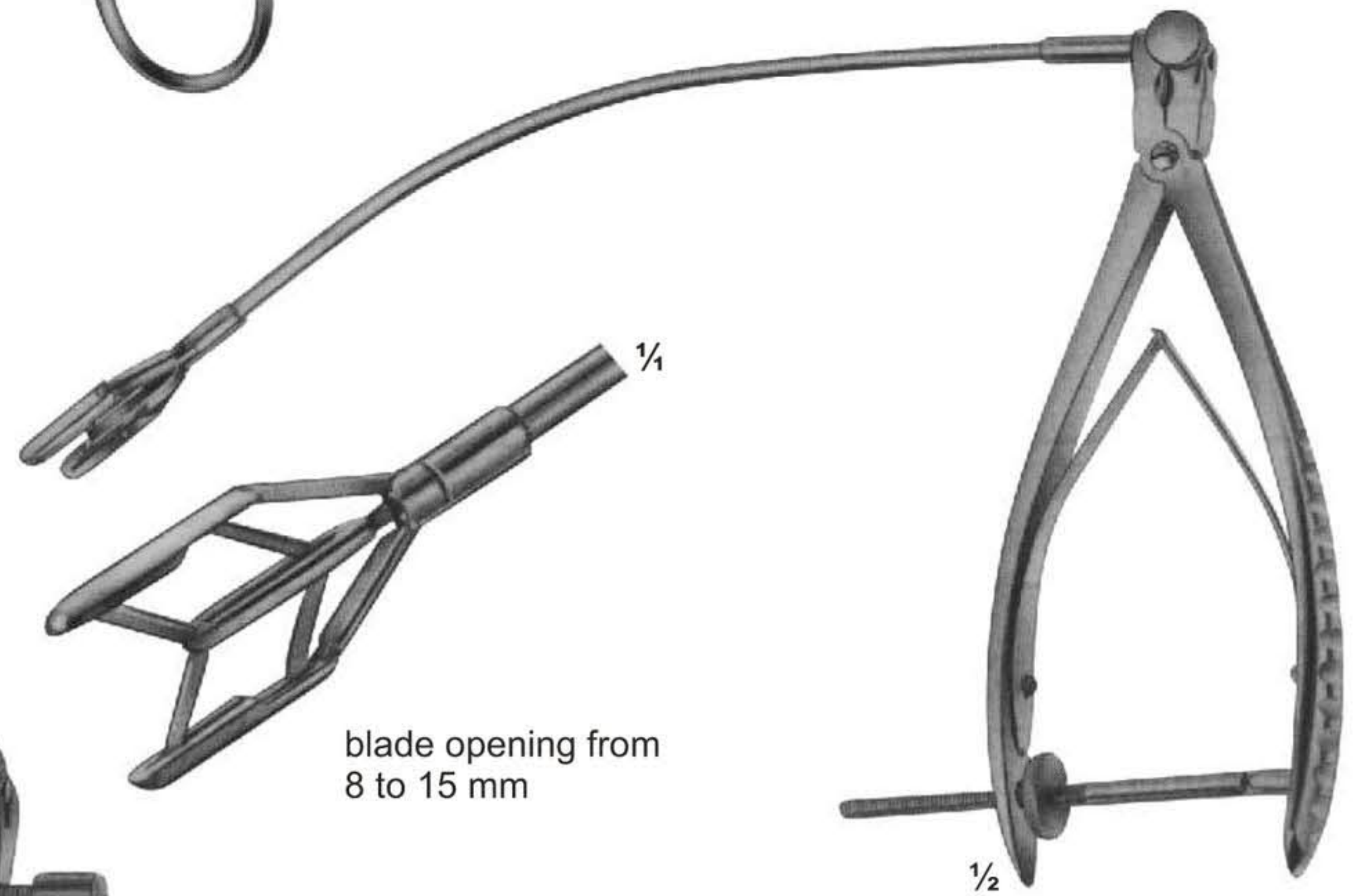

blade opening from  
8 to 15 mm

**17-144**  
**COOLEY**  
Dilator for  
mitral valve  
for children

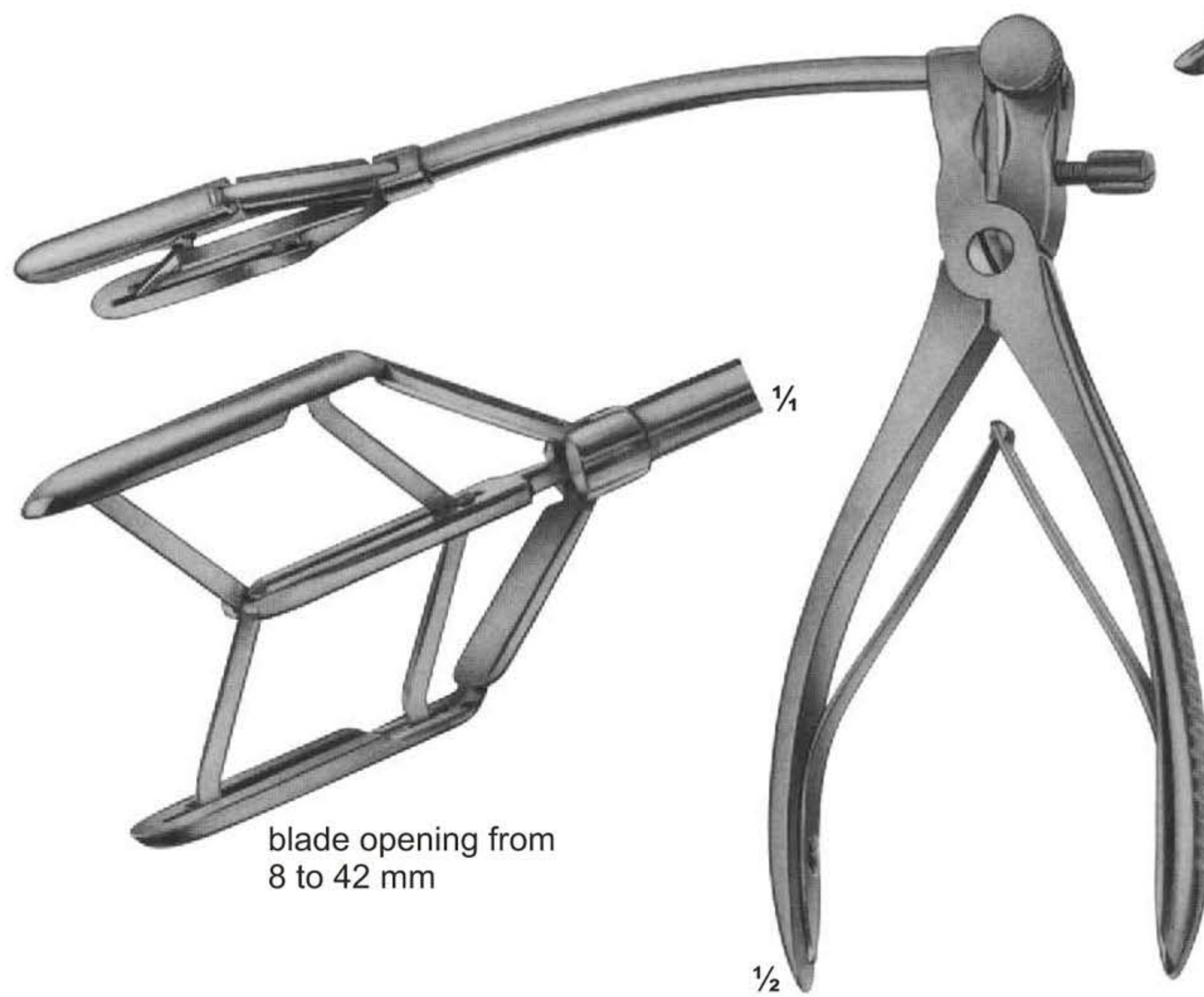

blade opening from  
8 to 42 mm

**17-143**  
**TUBBS**  
Dilator for  
mitral valve



# Biopotome and Aortic Dilators

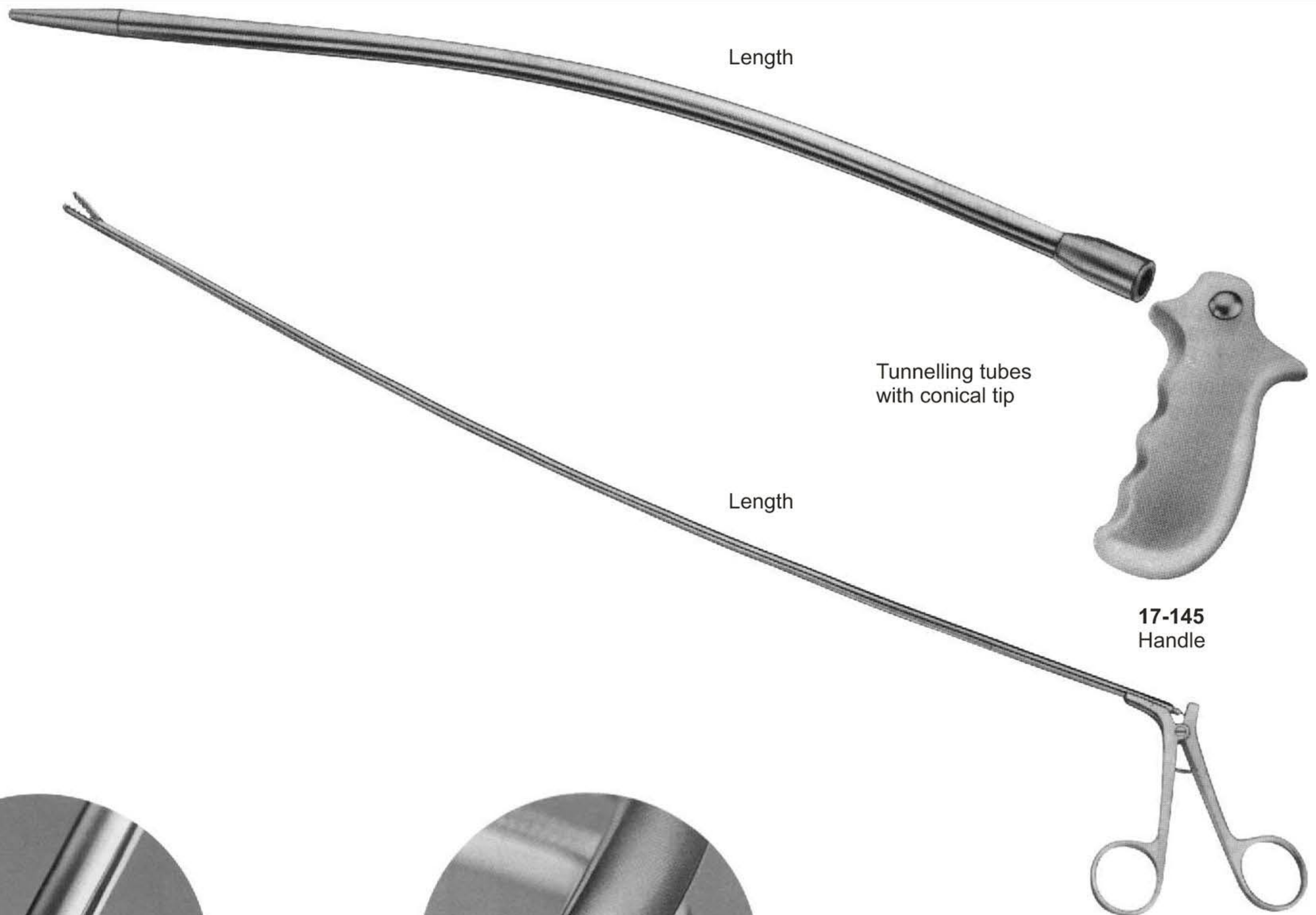

17-145  
Handle



17-146  
Forceps

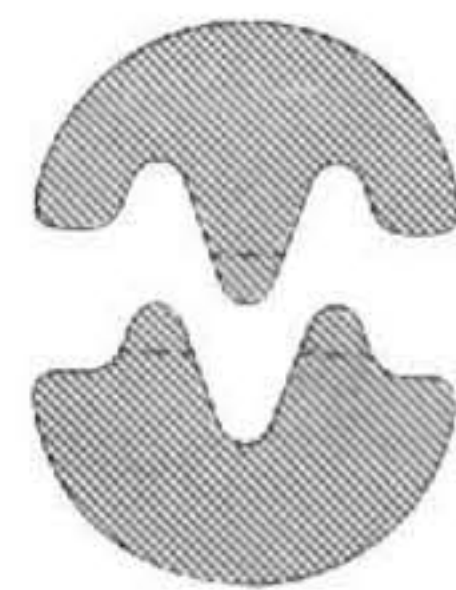
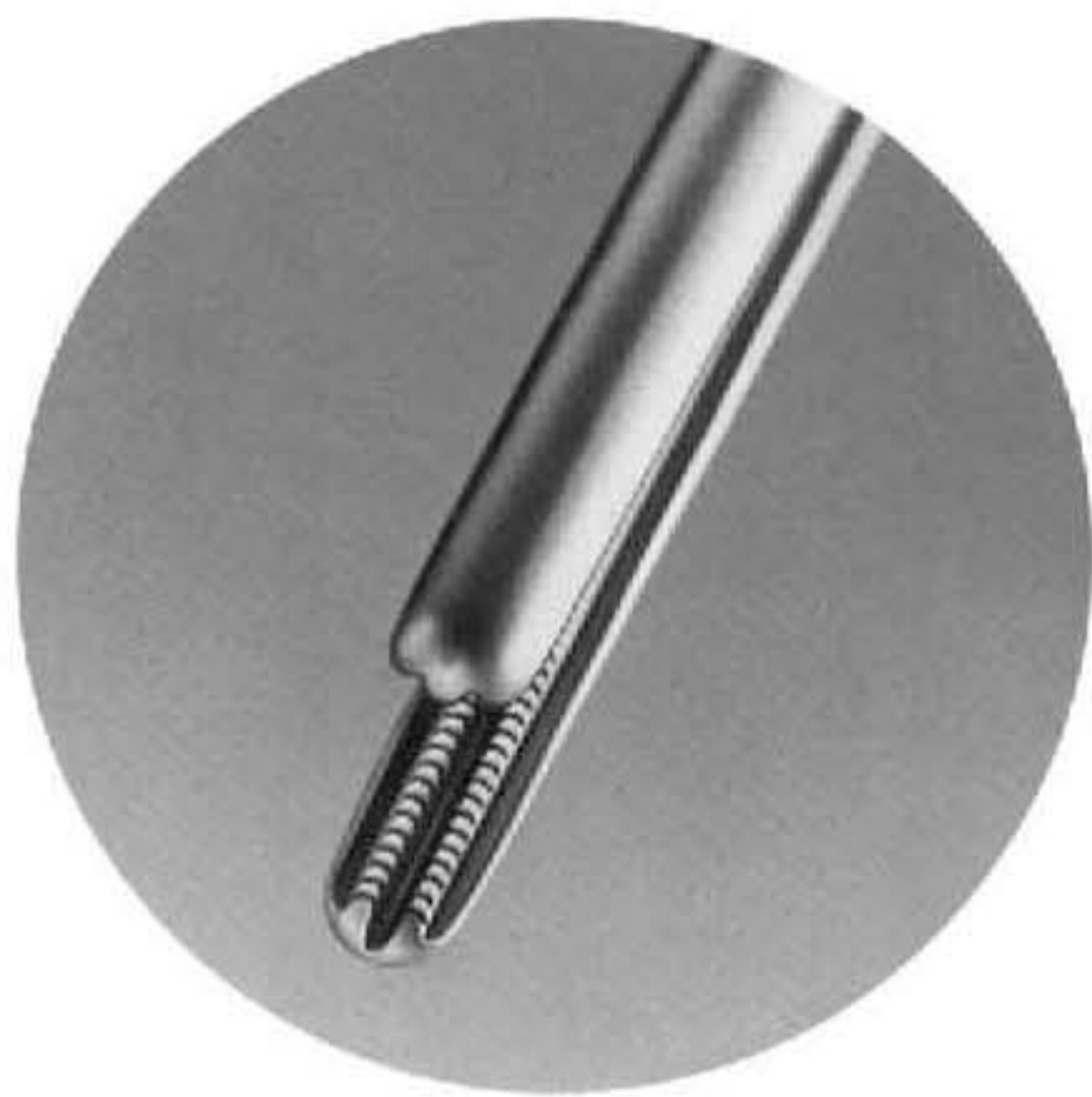

**DE BAKEY**

17-147  
1 : 2 rows of teeth

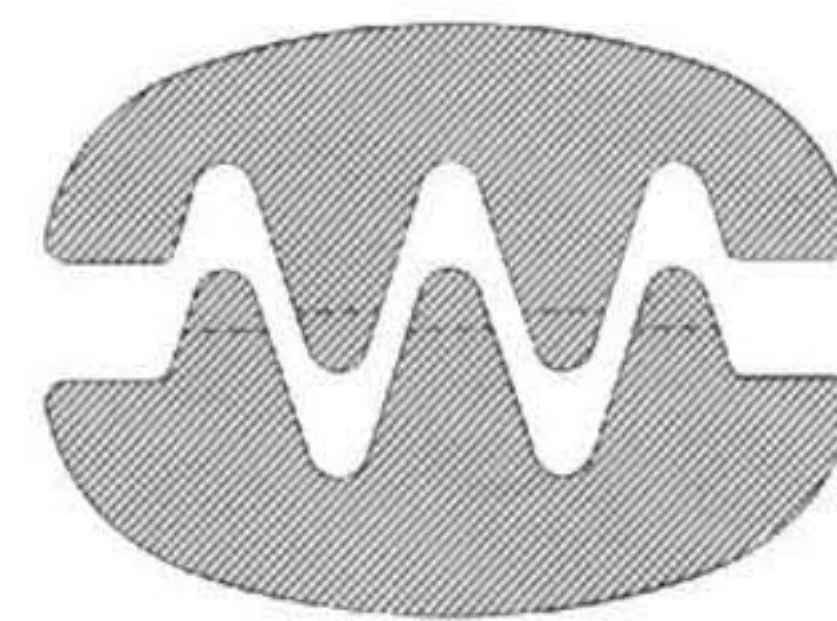
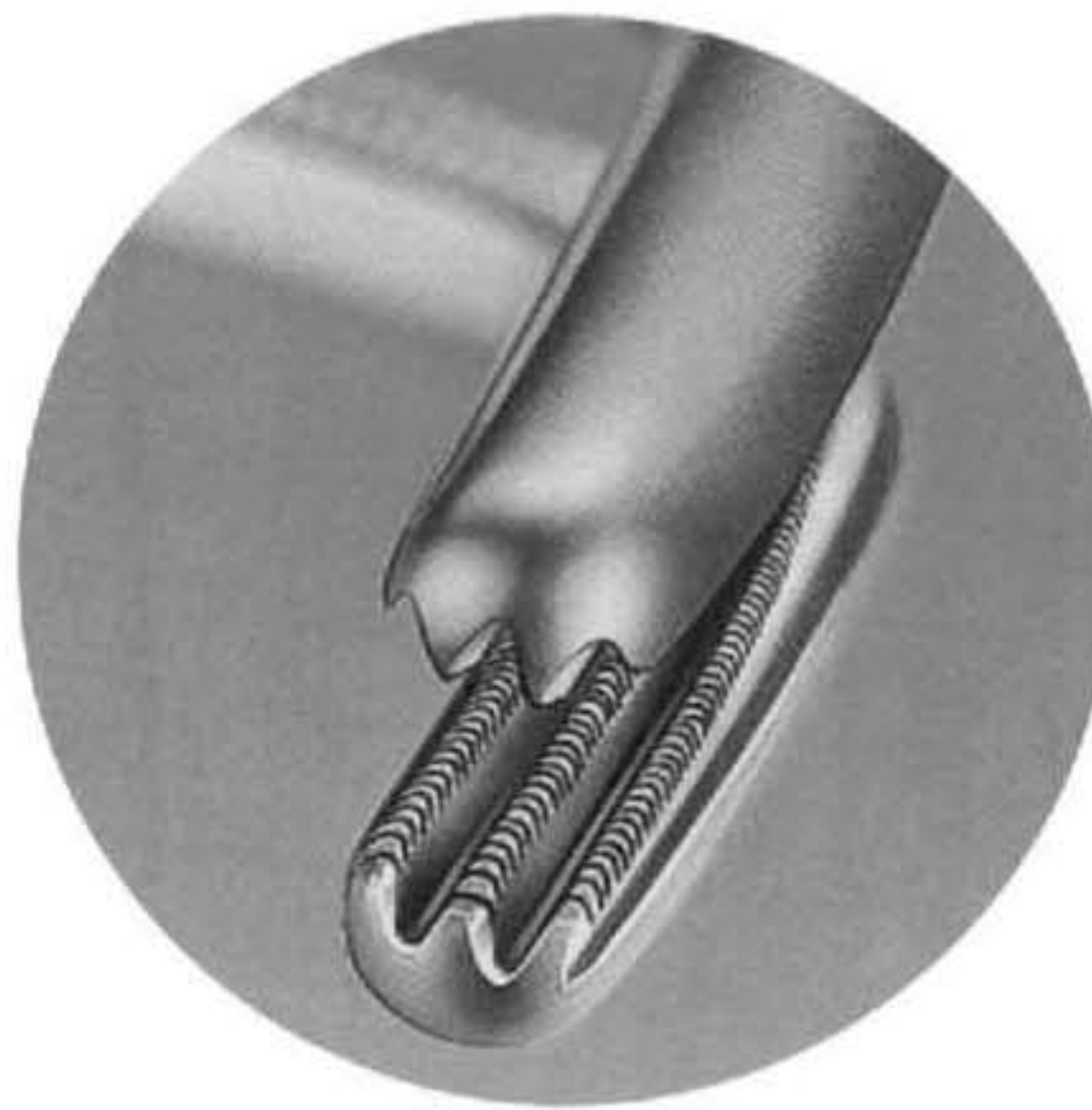

**DE BAKEY**

17-148  
2 : 3 rows of teeth

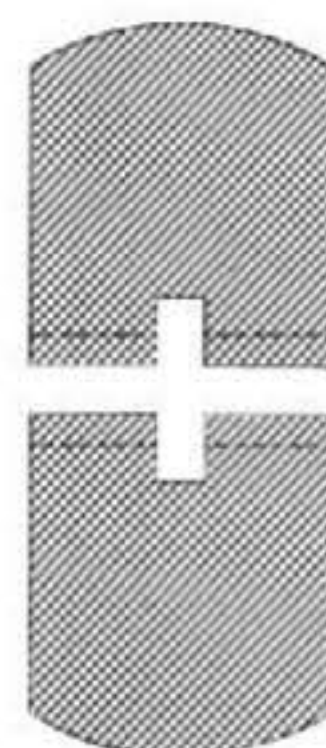
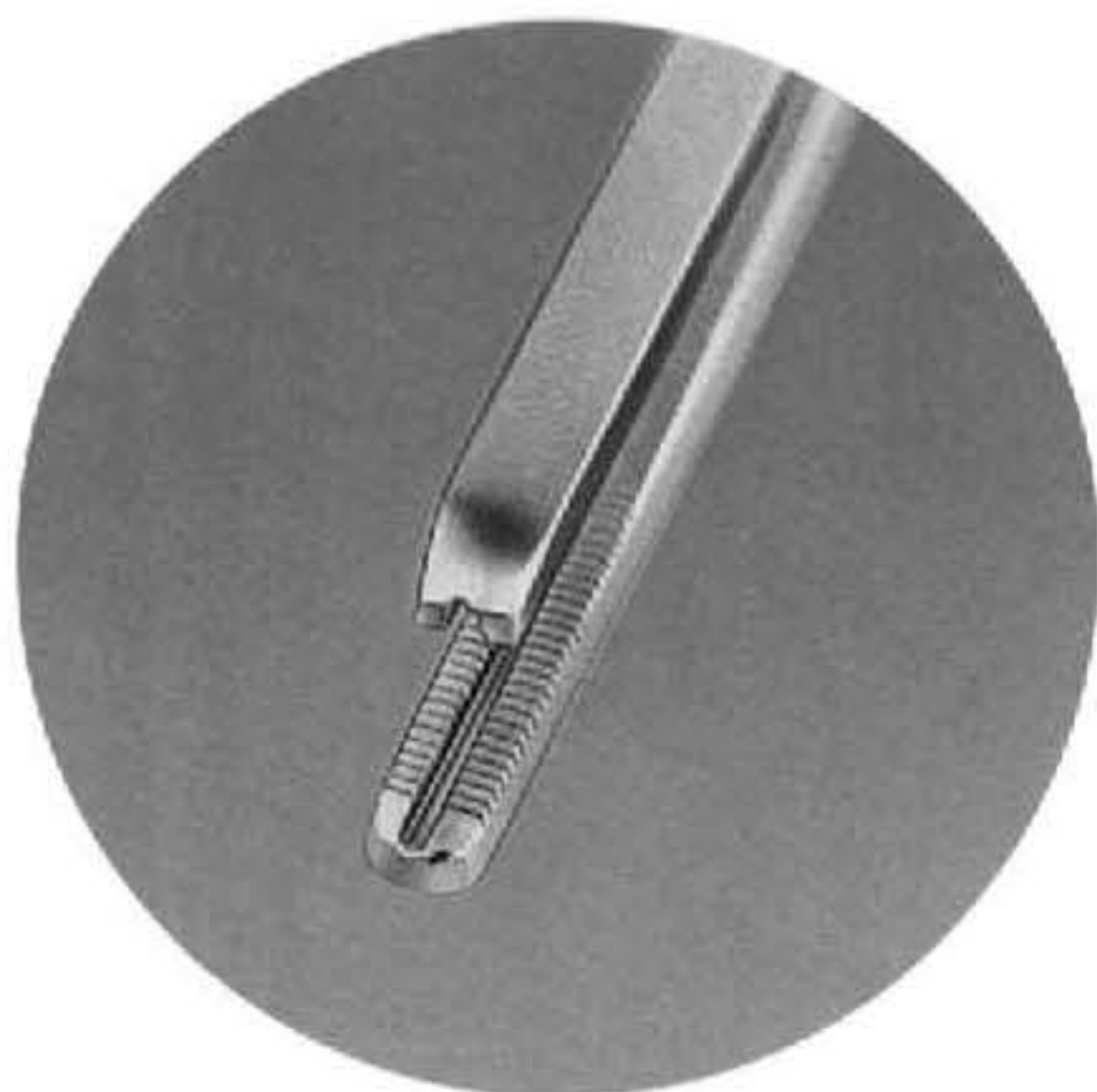

**COOLEY**

17-149  
2 : 2 rows of teeth

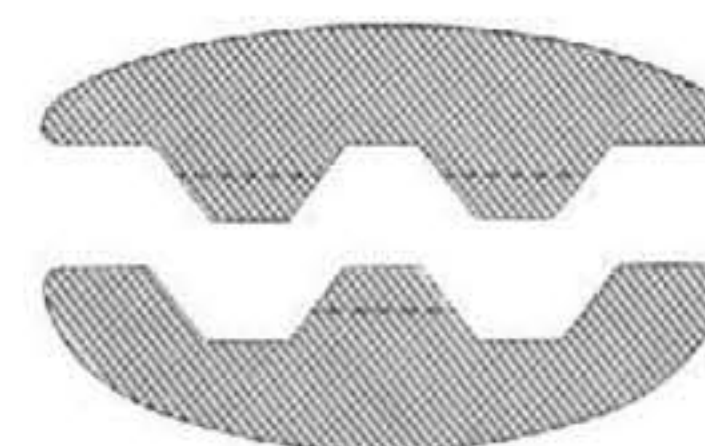
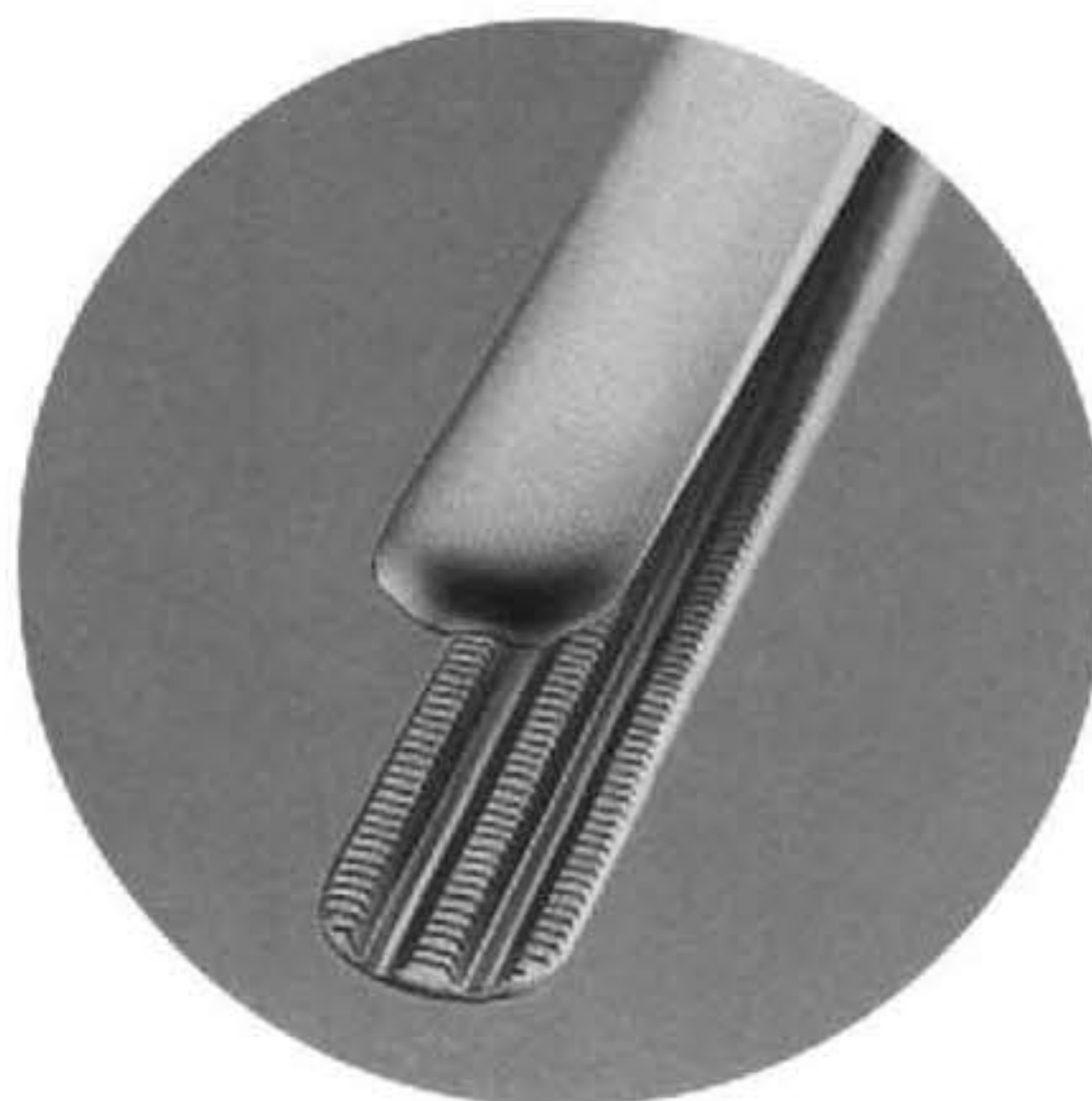

**DARDIK**

17-150  
2 : 3 rows of teeth



Ultra-Light-Forceps

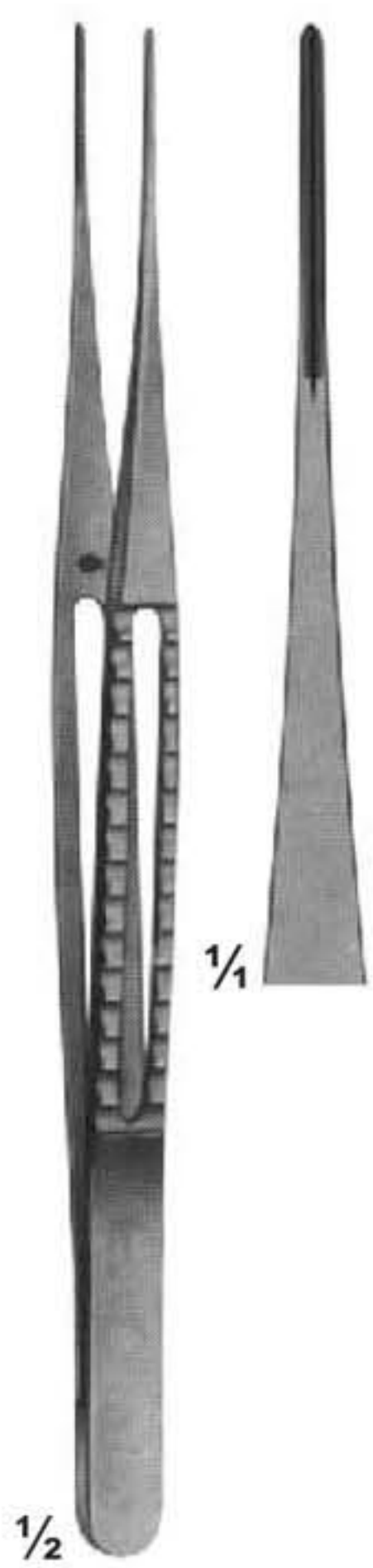

**17-151**  
Width of jaws  
1,5 mm  
Length  
150mm

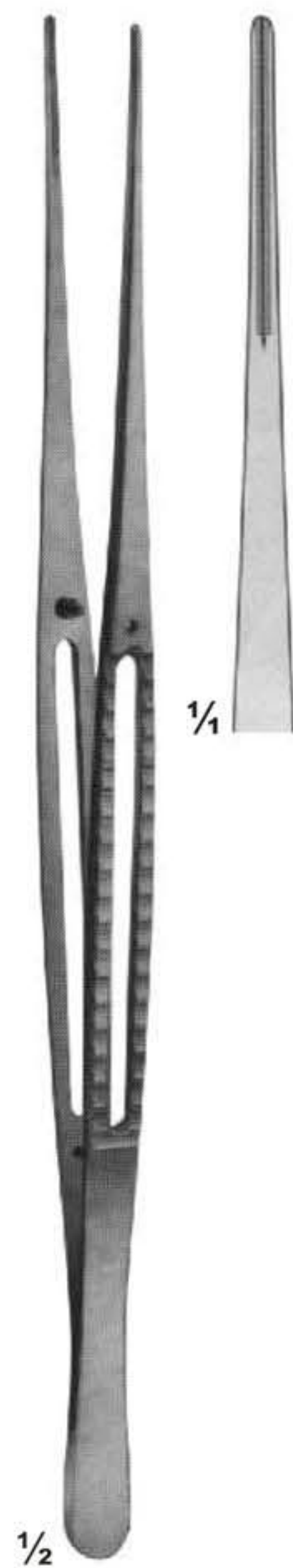

**17-152**  
1,5 mm  
200 mm



**17-153**  
1,5 mm  
240 mm



**17-154**  
1,5 mm  
300 mm



# Ultra-Light-Forceps

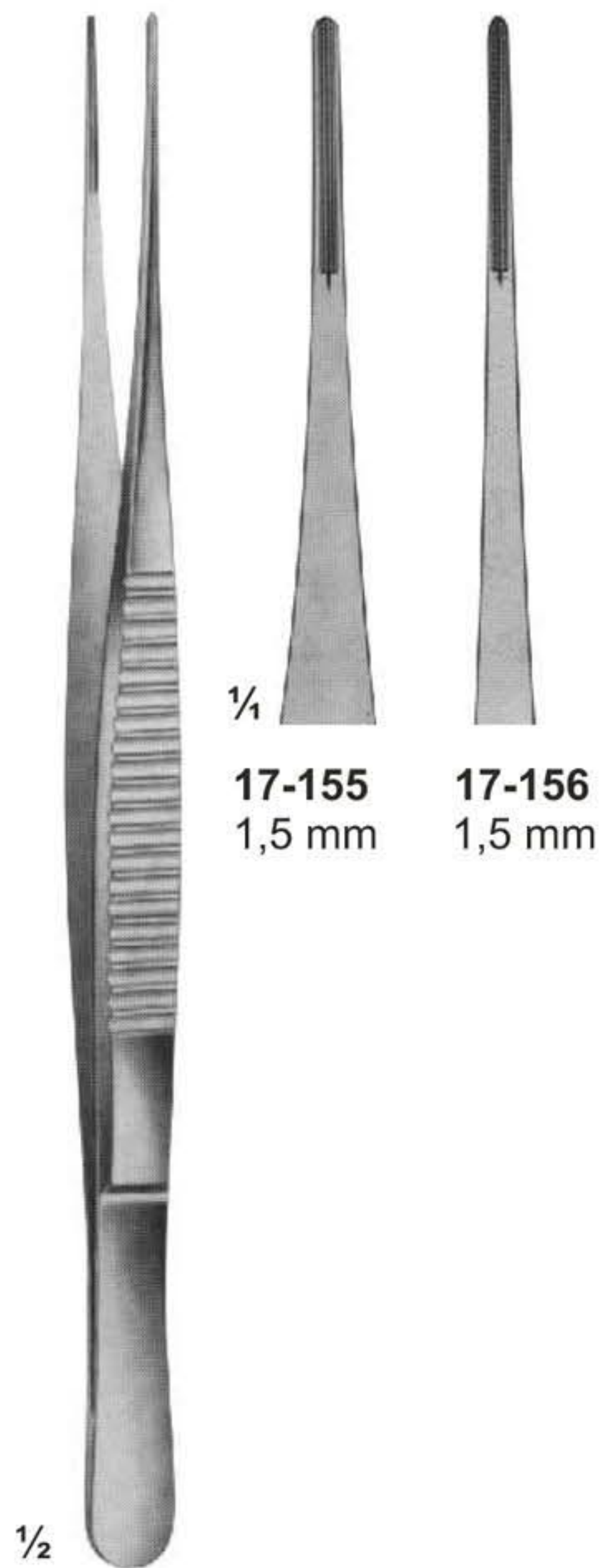

**17-155**  
1,5 mm

**17-156**  
1,5 mm

**17-155 - 156**  
DE BAKEY  
150 mm  
300 mm

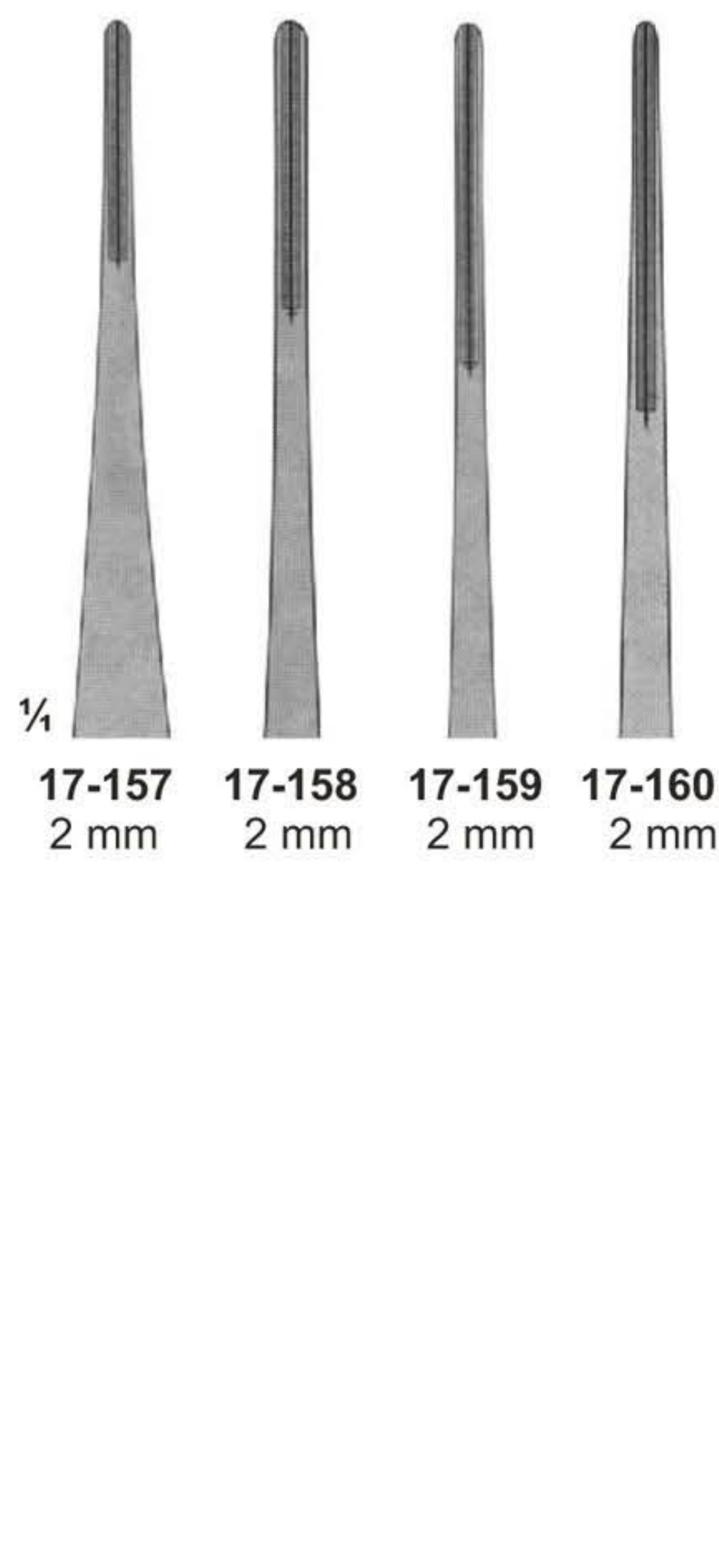

**17-157**  
2 mm

**17-158**  
2 mm

**17-159**  
2 mm

**17-160**  
2 mm

**17-157 - 160**  
DE BAKEY  
150 mm 200 mm  
300 mm 240 mm

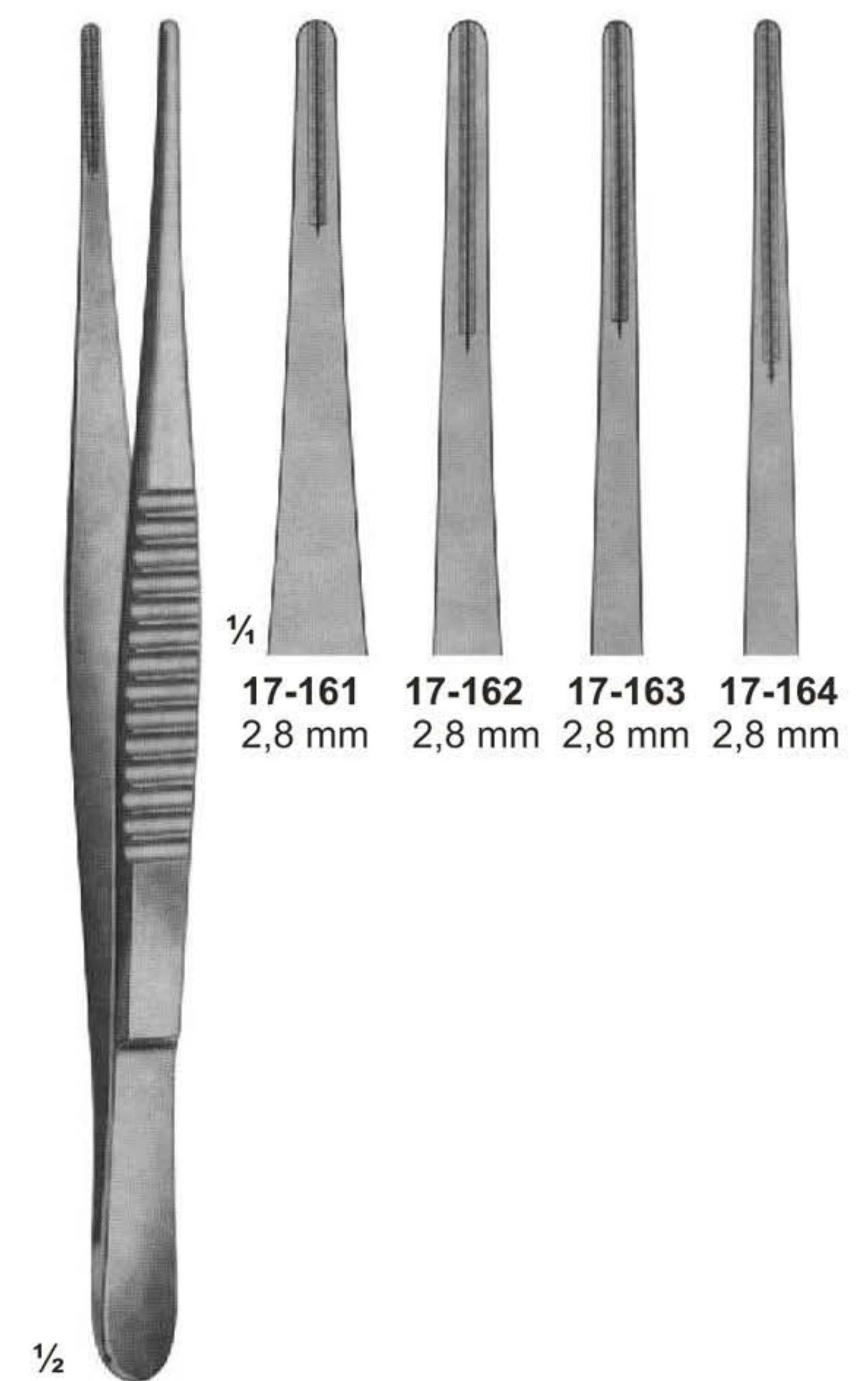

**17-161**  
2,8 mm

**17-162**  
2,8 mm

**17-163**  
2,8 mm

**17-164**  
2,8 mm

**17-161 - 164**  
DE BAKEY  
150 mm 200 mm  
300 mm 240 mm

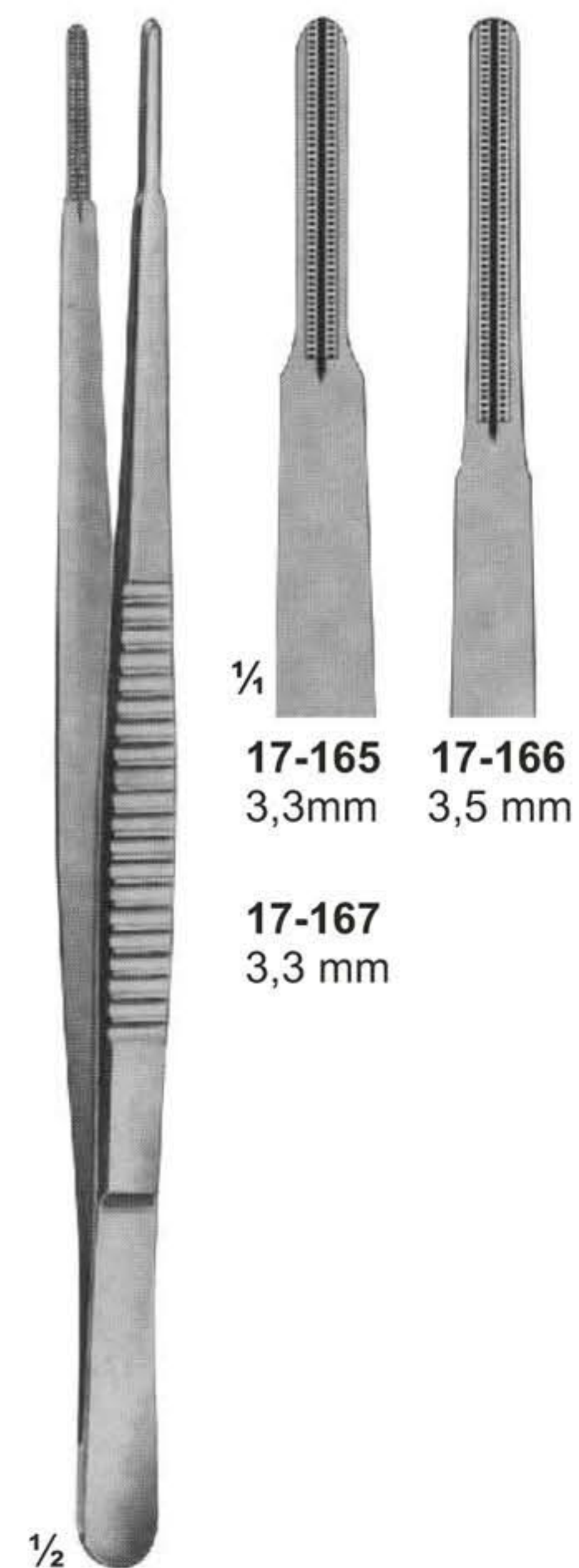

**17-165**  
3,3mm

**17-166**  
3,5 mm

**17-167**  
3,3 mm

**17-165 - 167**  
DE BAKEY  
200 mm  
300 mm 240 mm

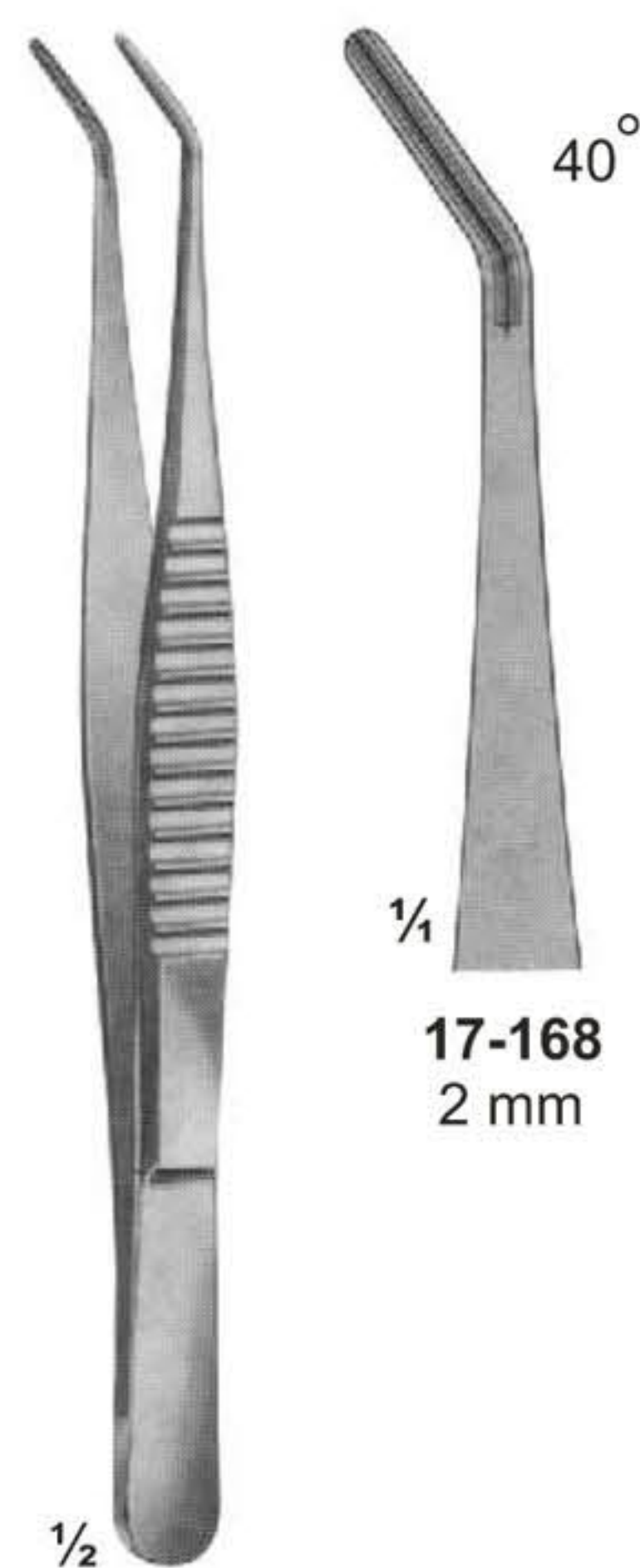

**17-168**  
2 mm

**17-168**  
DE BAKEY  
150 mm

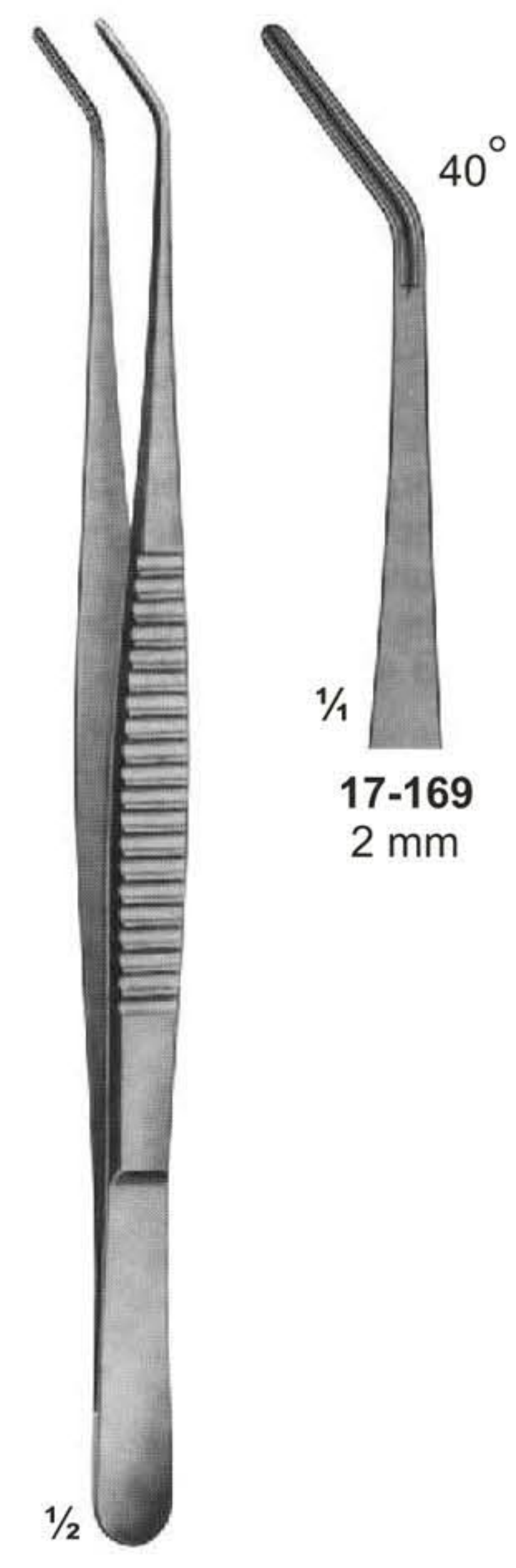

**17-169**  
2 mm

**17-169**  
DE BAKEY  
200 mm



# Ring Handle Bulldog Clamps

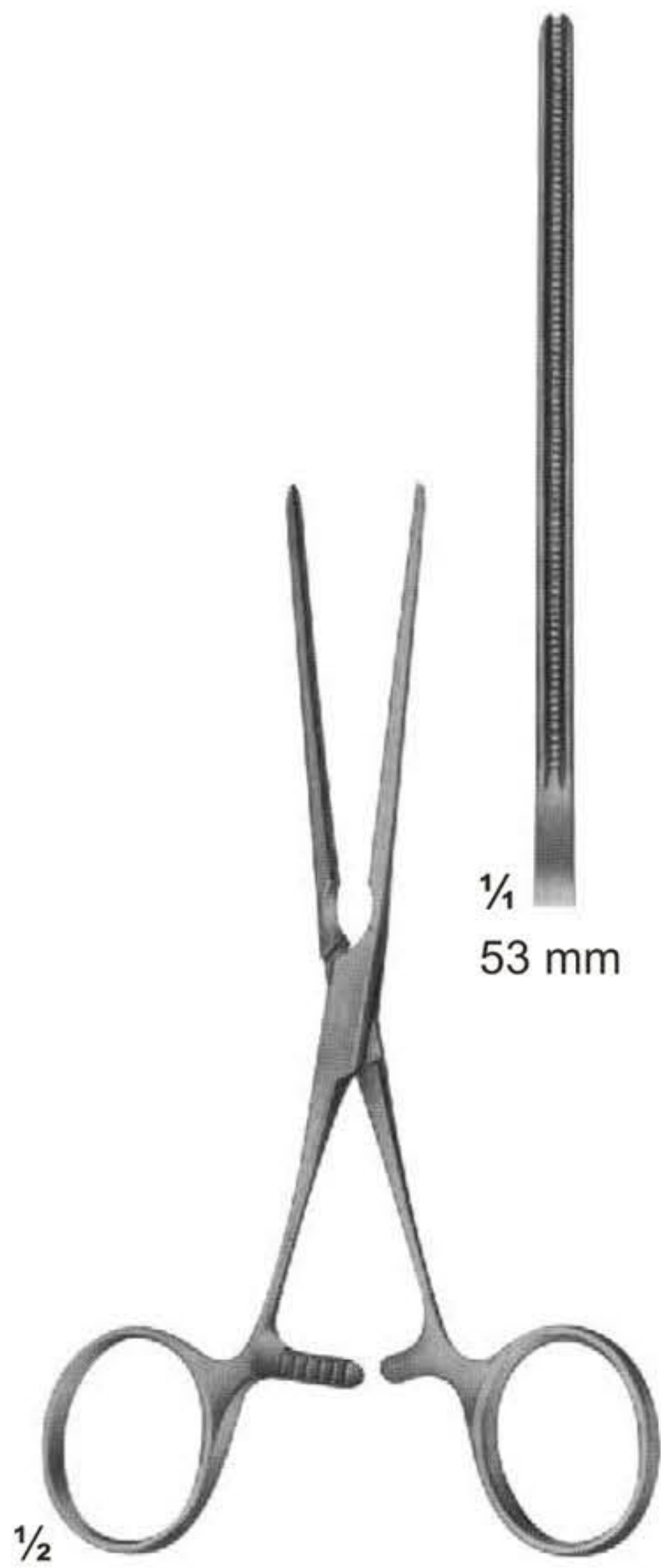

**17-170**  
DE-BAKEY  
gerade straight  
130 mm

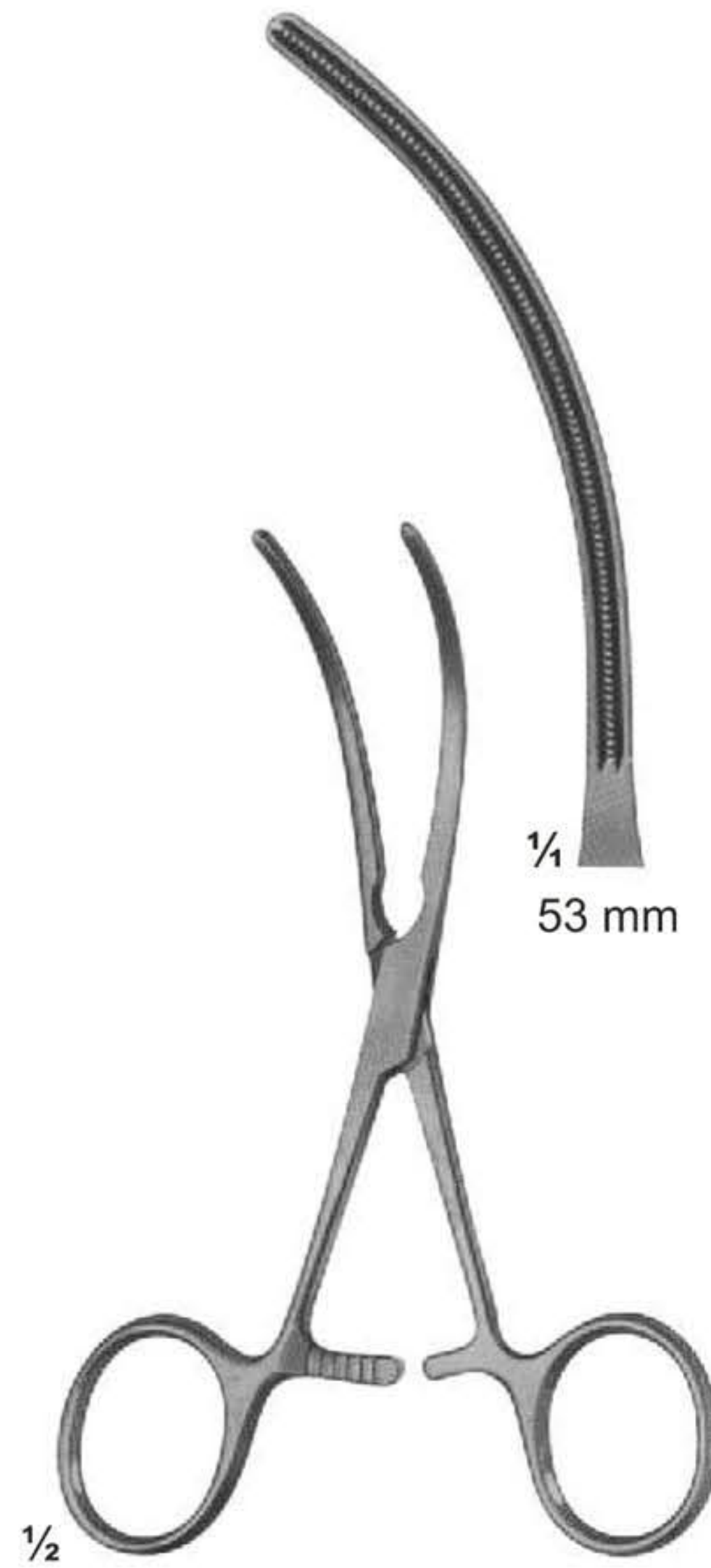

**17-171**  
DE-BAKEY  
Maul gebogen  
curved jaws  
125 mm

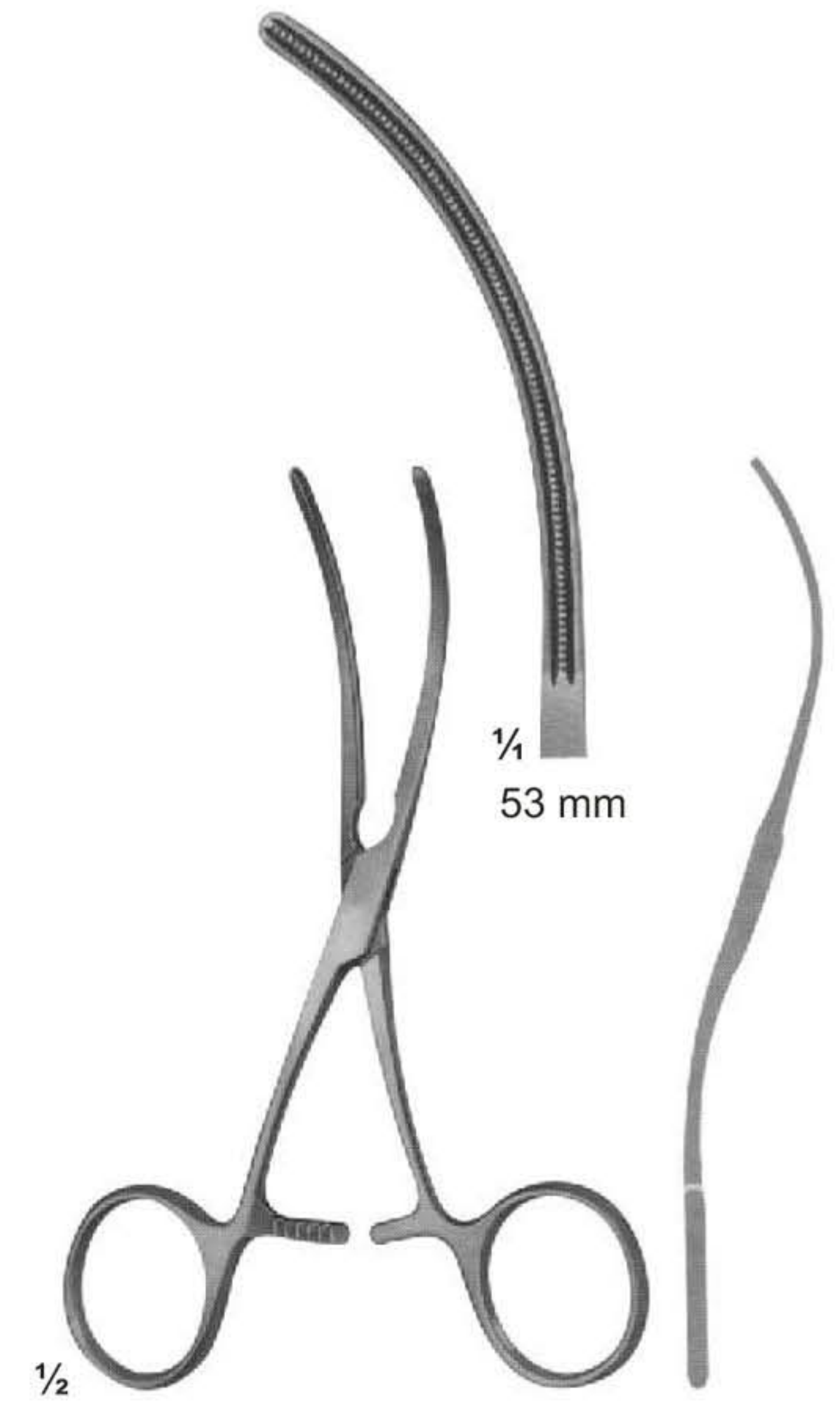

**17-172**  
DE-BAKEY  
S-shaped curved  
125 mm

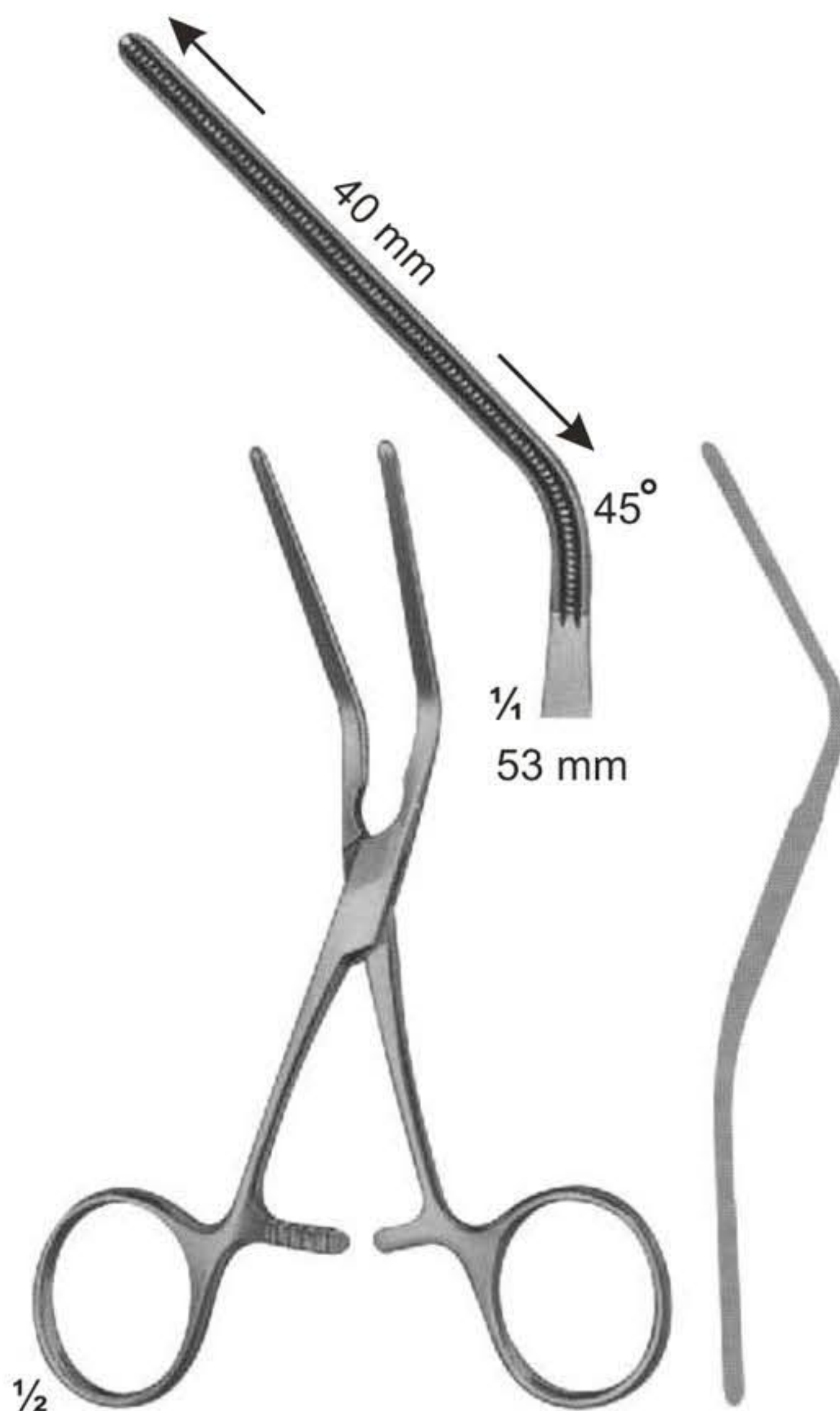

**17-173**  
DE-BAKEY  
45° winklig gebogen  
angled 45°  
125 mm

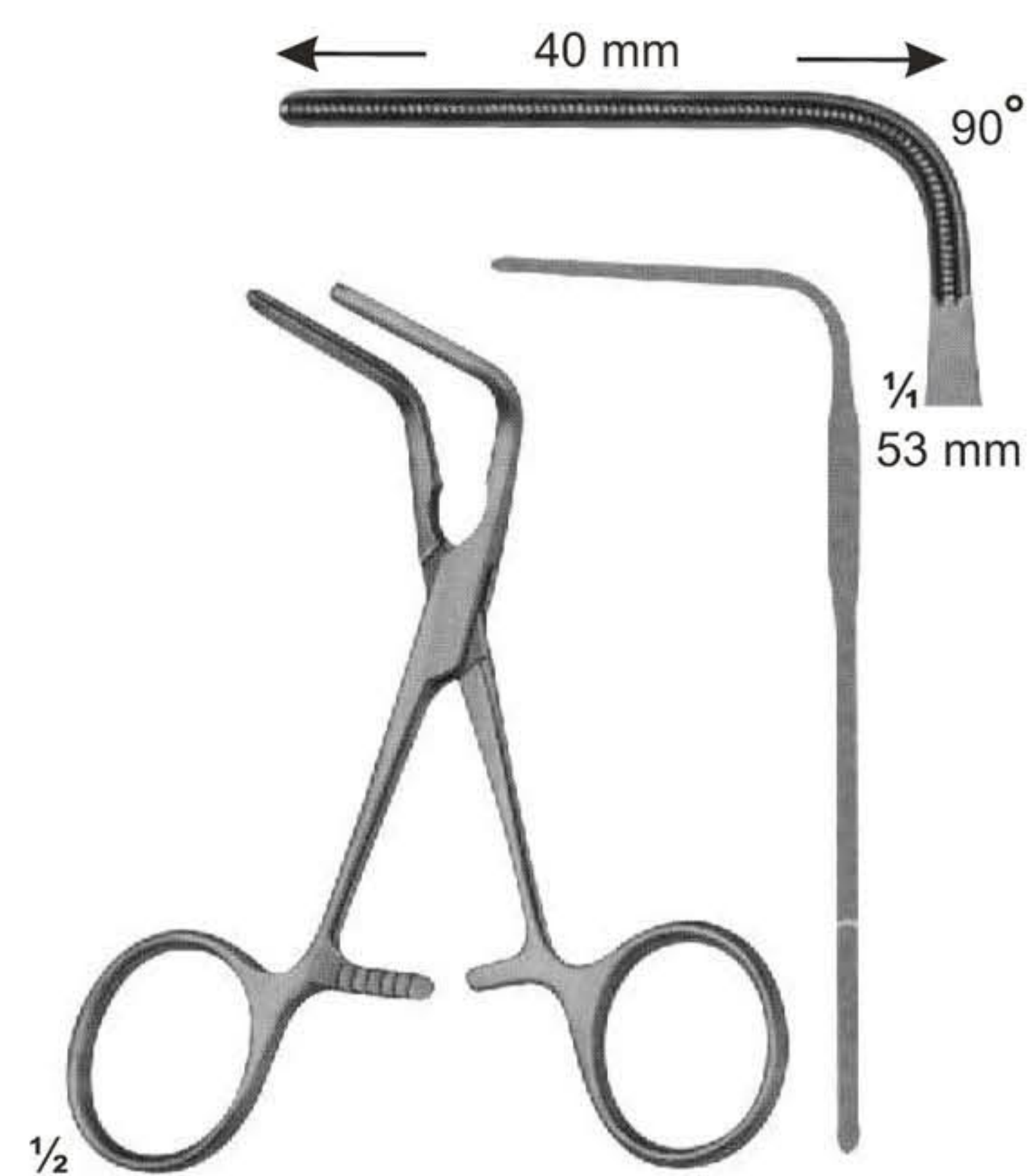

**17-174**  
DE-BAKEY  
90° winklig gebogen  
angled 90°  
105 mm



# Anastomosis-and Multi-Purpose-Clamps for Neonatales

graduated



1/2

**17-175 - 178**  
CASTANESA

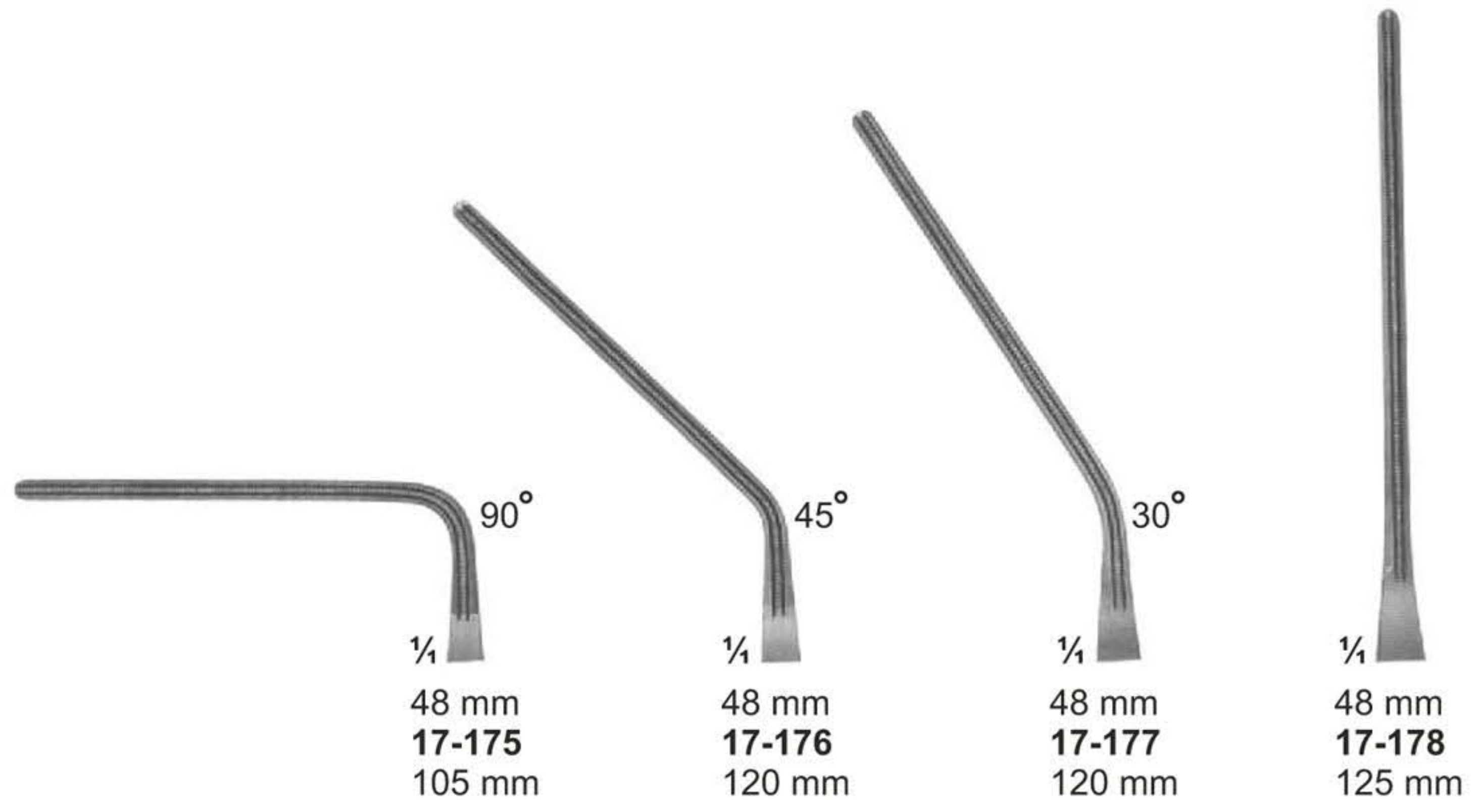

graduated



1/2

**17-179 - 182**  
CASTANESA

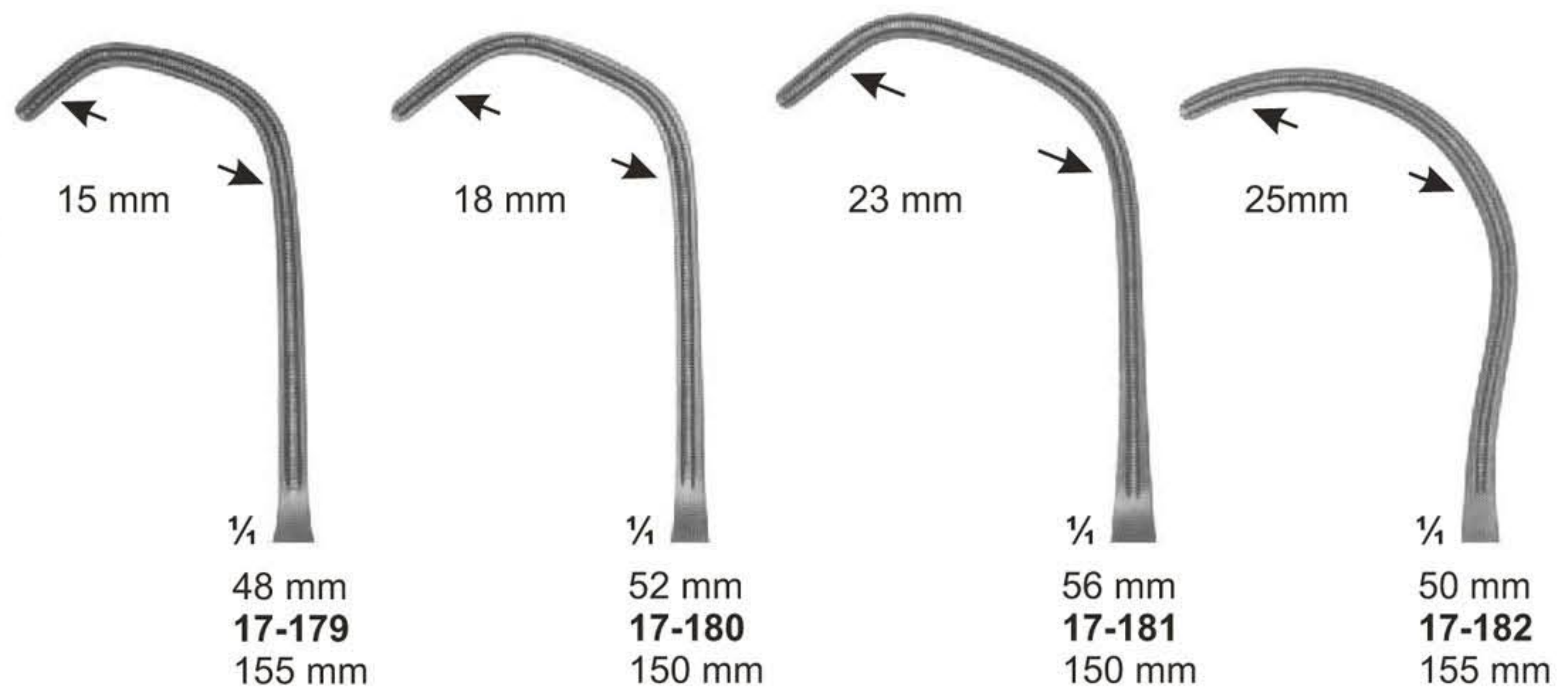



**Anastomosis-and Multi-Purpose-Clamps-Pediatric types**

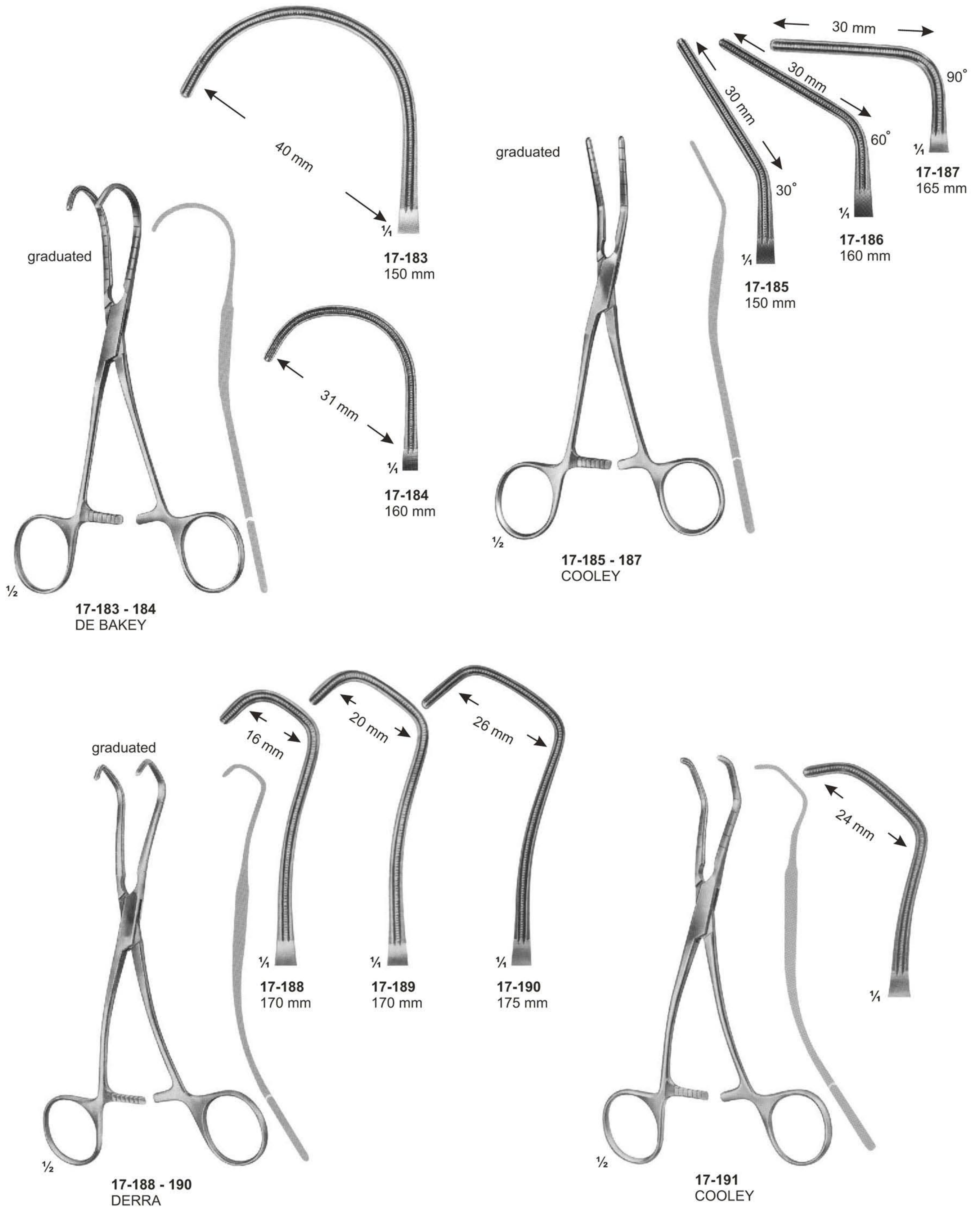



# Non-traumatic Haemostatic Forceps

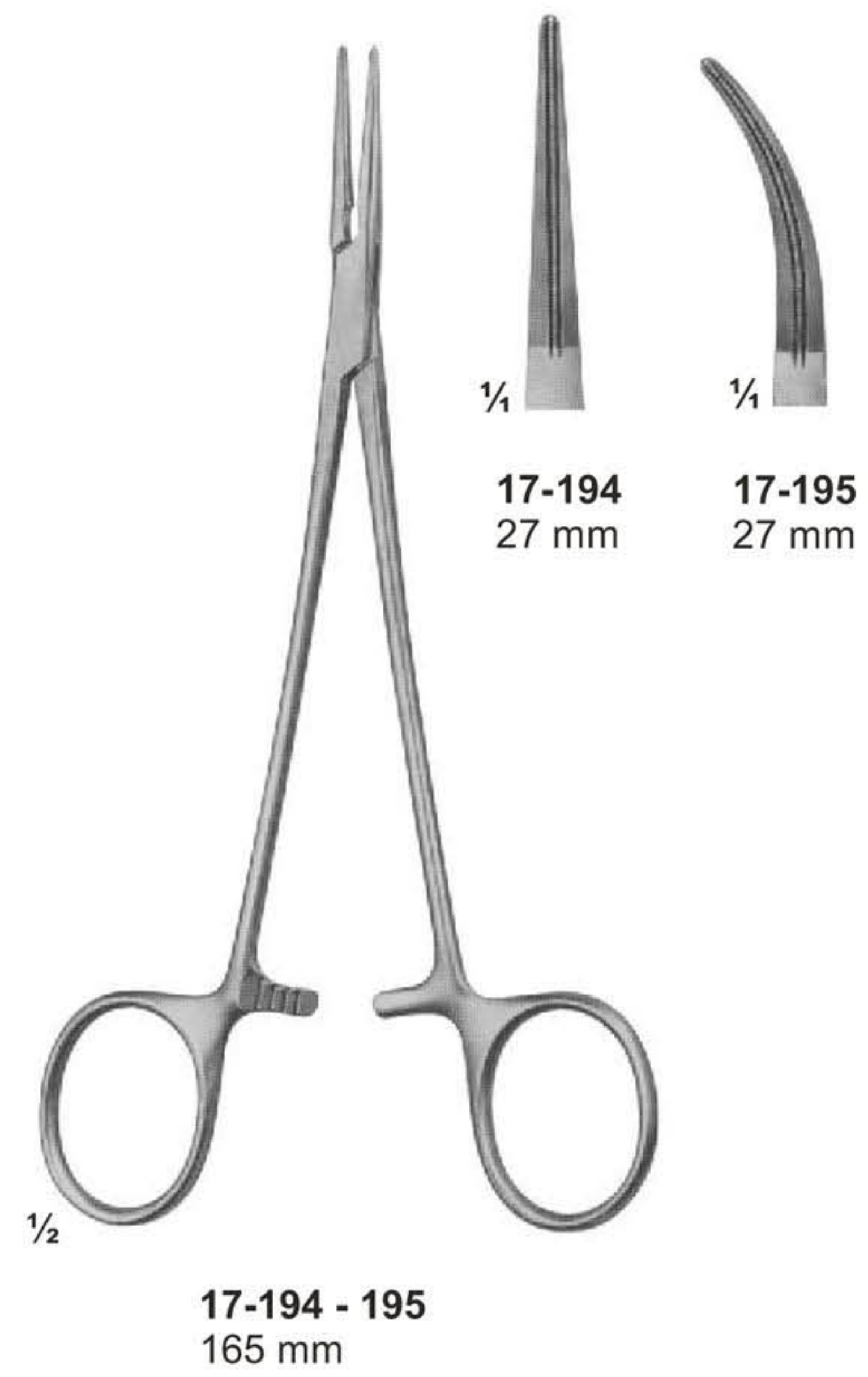
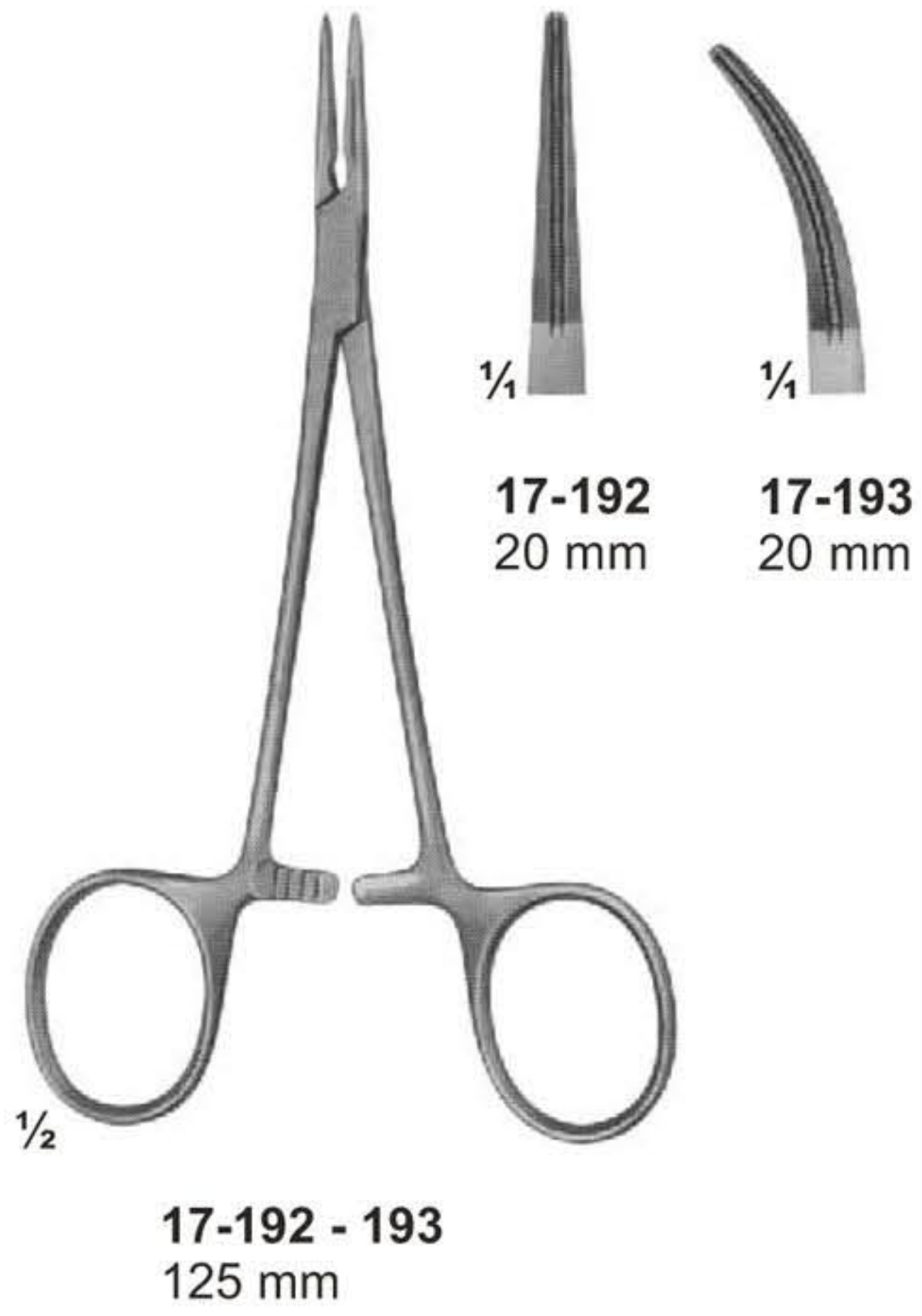



# Non-traumatic Haemostatic Forceps

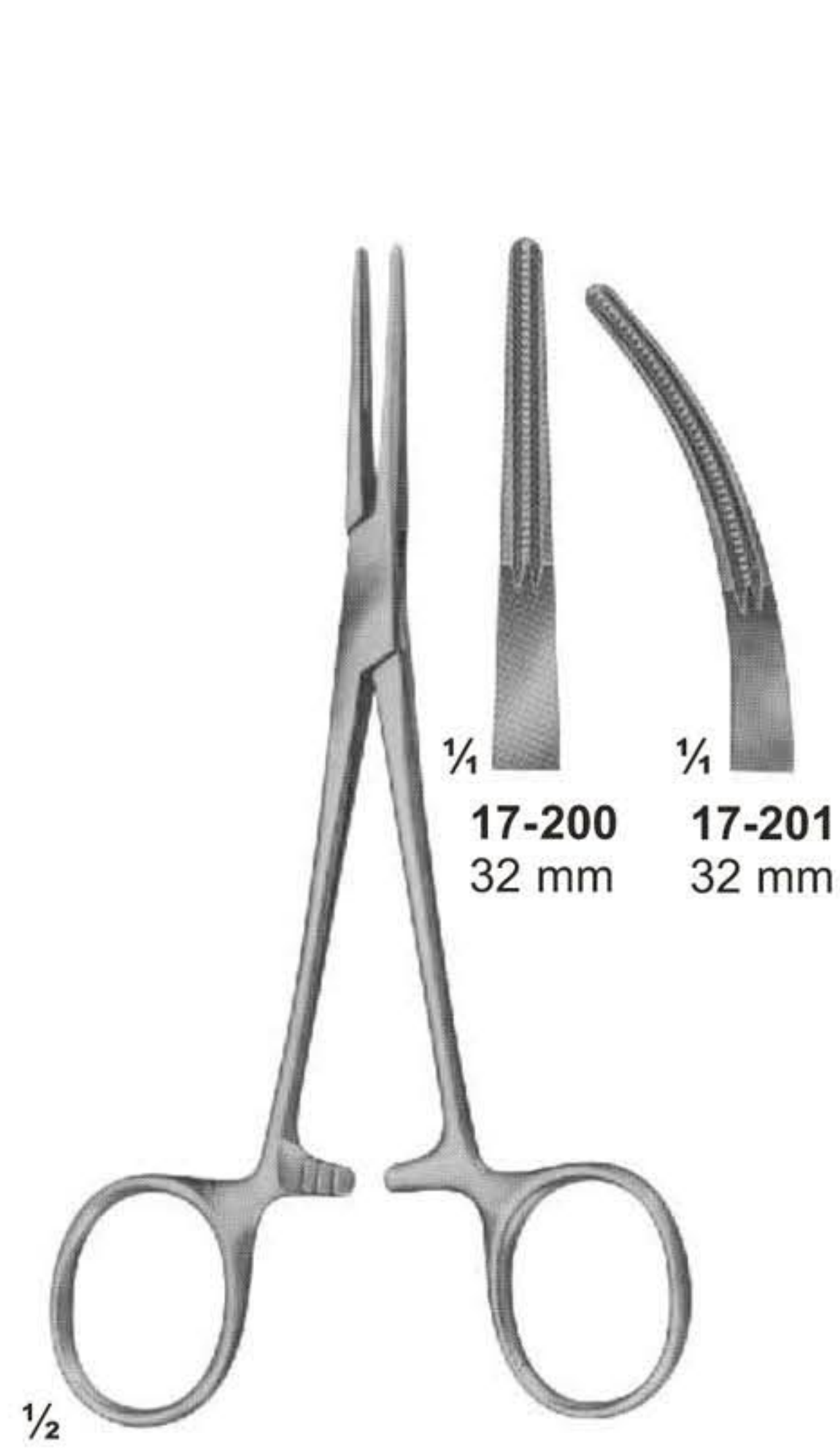

**17-200 - 201**  
DE-BAKEY-KELLY  
140 mm

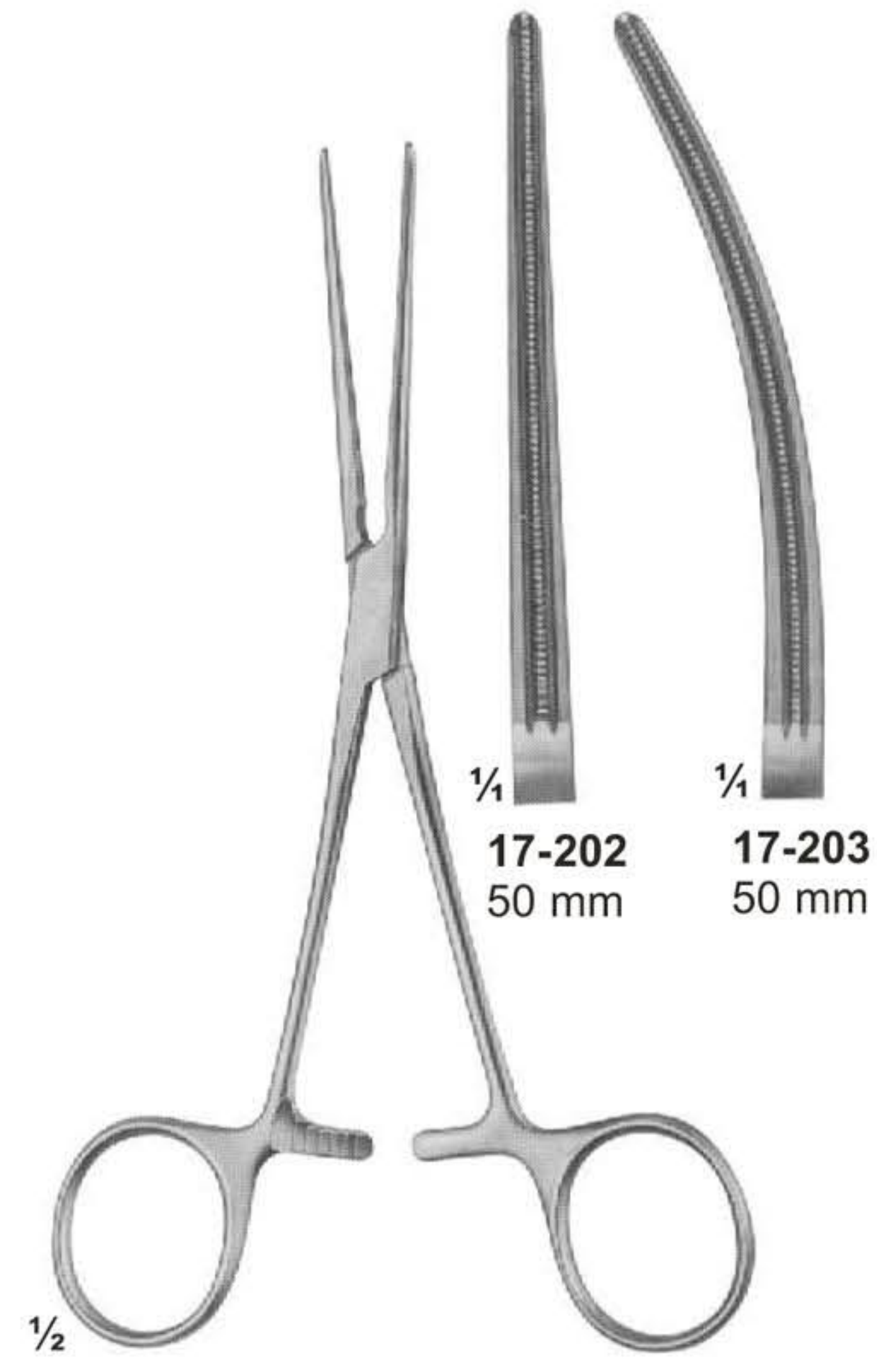

**17-202 - 203**  
PEAN  
155 mm

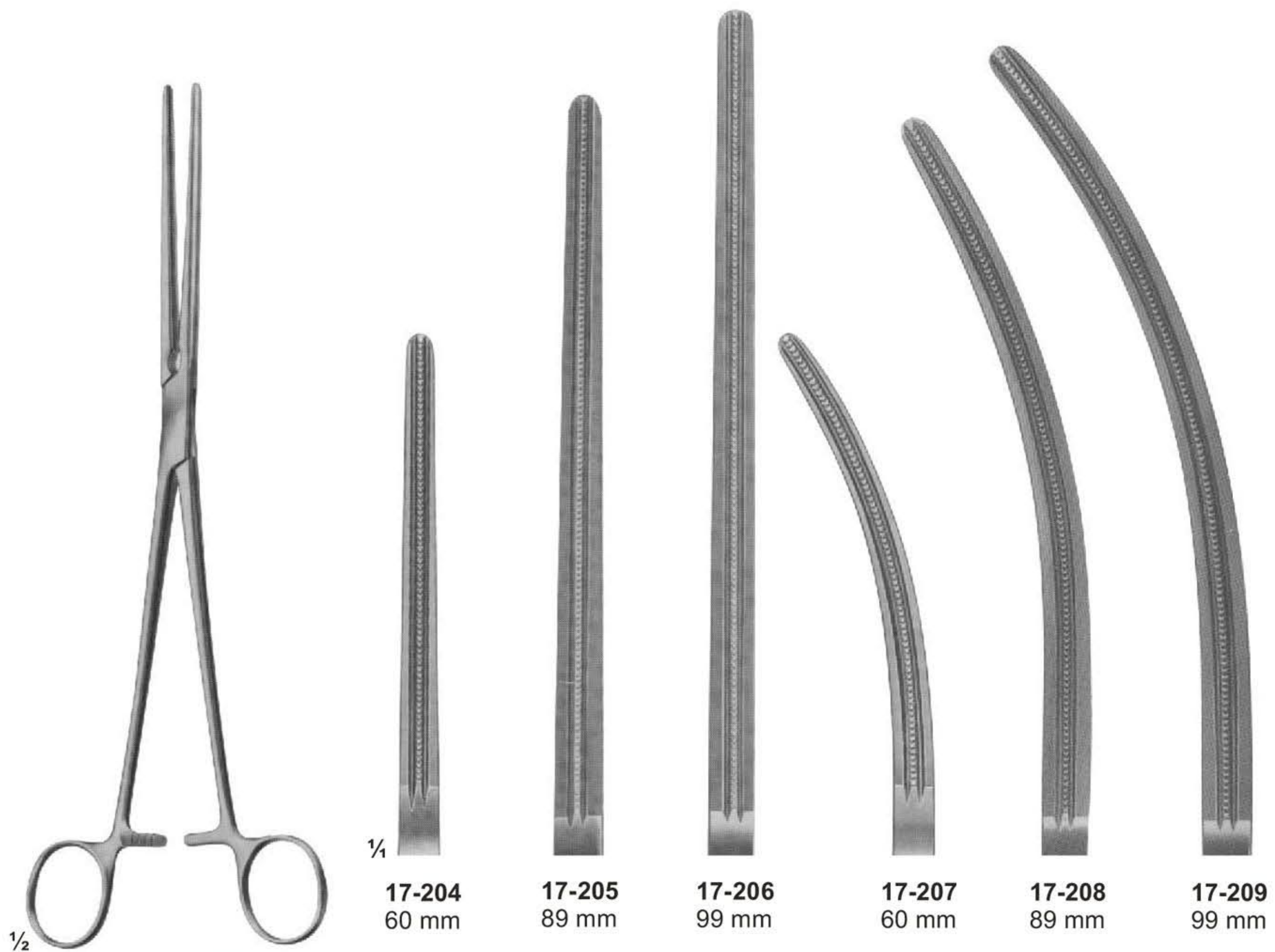

**17-204 - 209**  
DE-BAKEY-PEAN      DE-BAKEY-PEAN  
17-204 200 mm      17-207 200 mm  
17-205 265 mm      17-208 260 mm  
17-206 280 mm      17-209 275 mm



Anastomosis Clamps

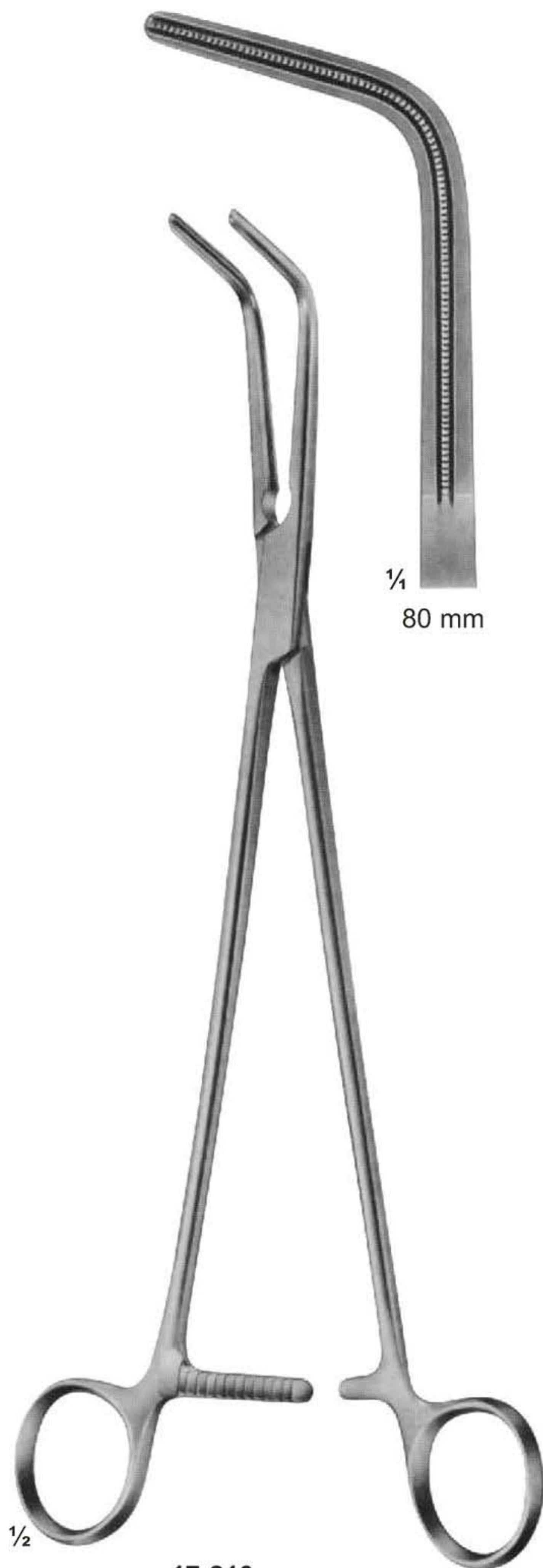

**17-210**  
DE-BAKEY-MIXTER  
285 mm

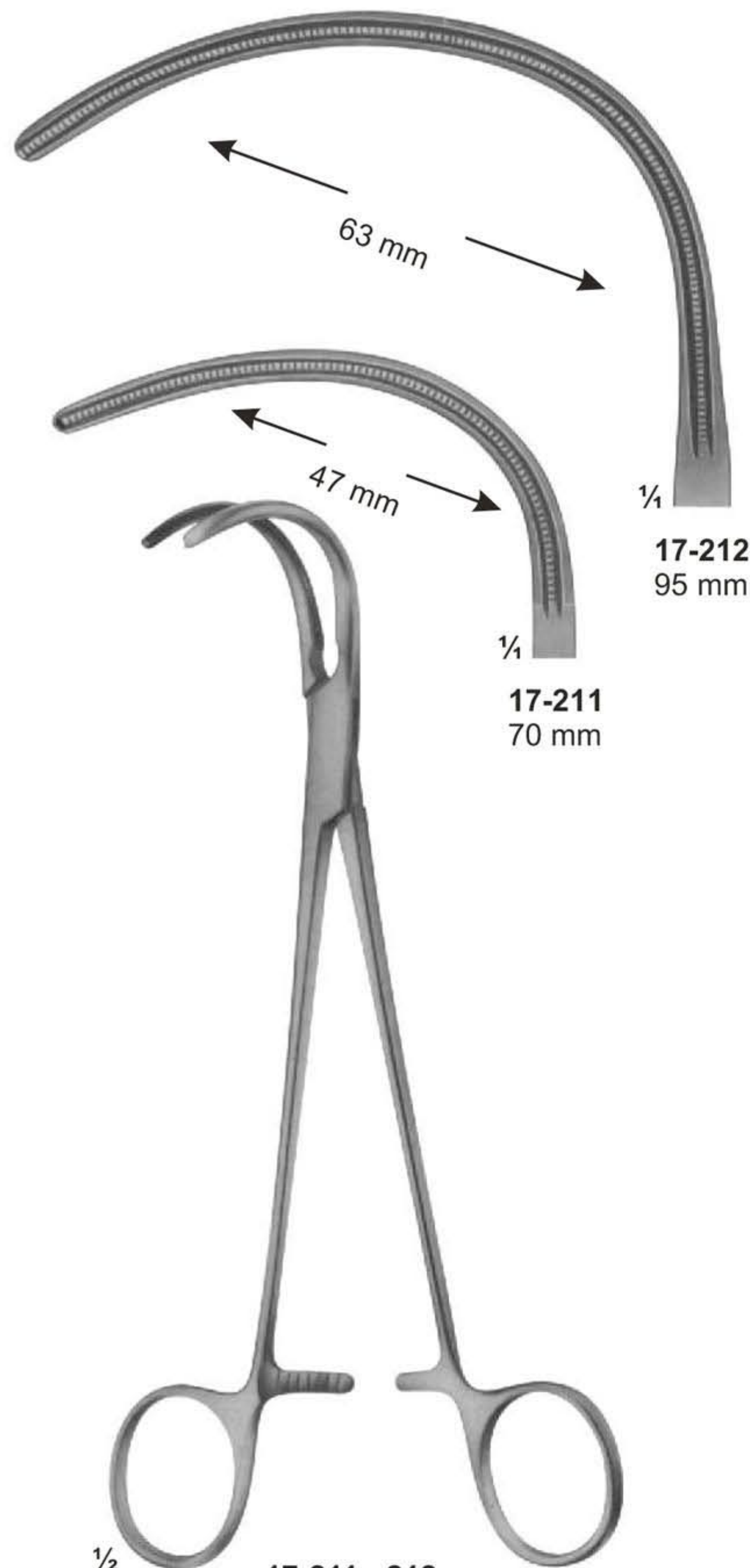

**17-211 - 212**  
GLOVER  
245 mm

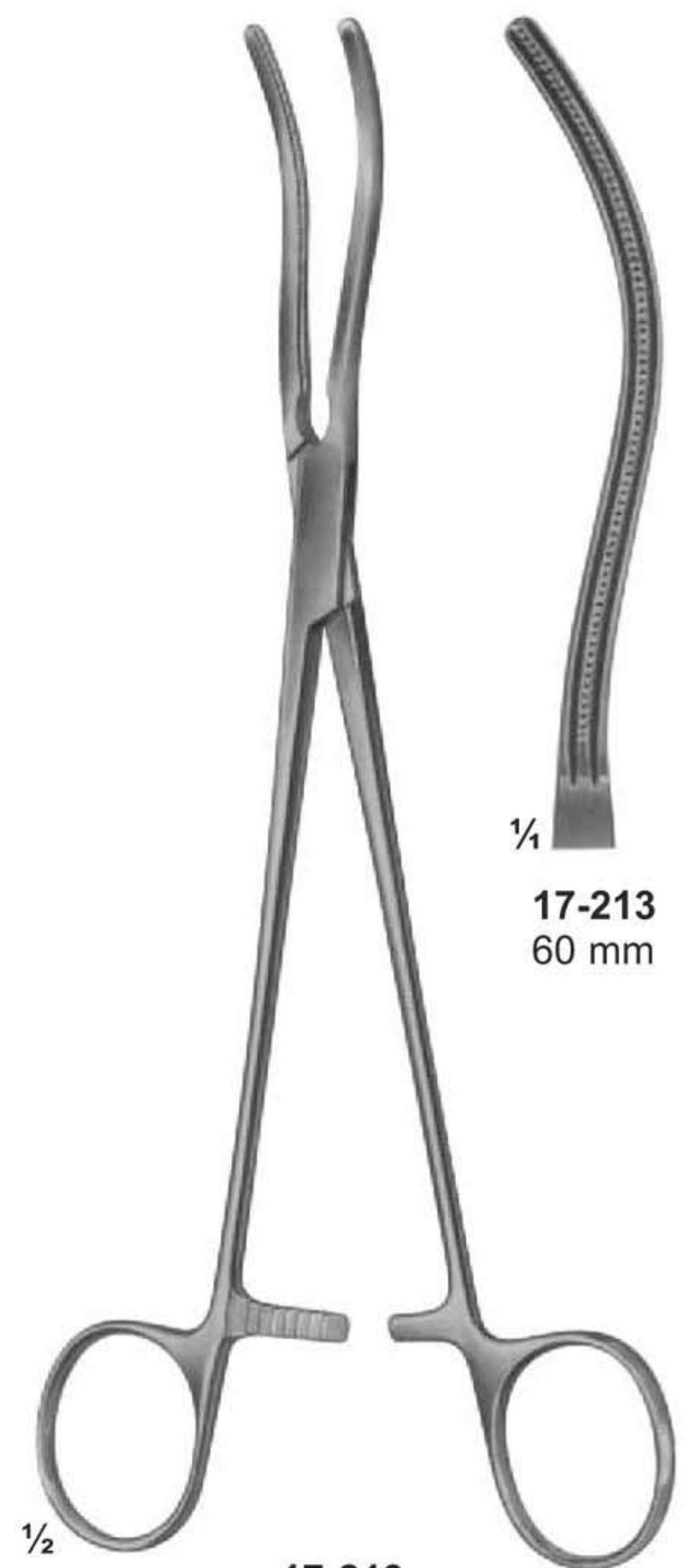

**17-213**  
GLOVER  
220 mm



# Vena-Cava Clamps

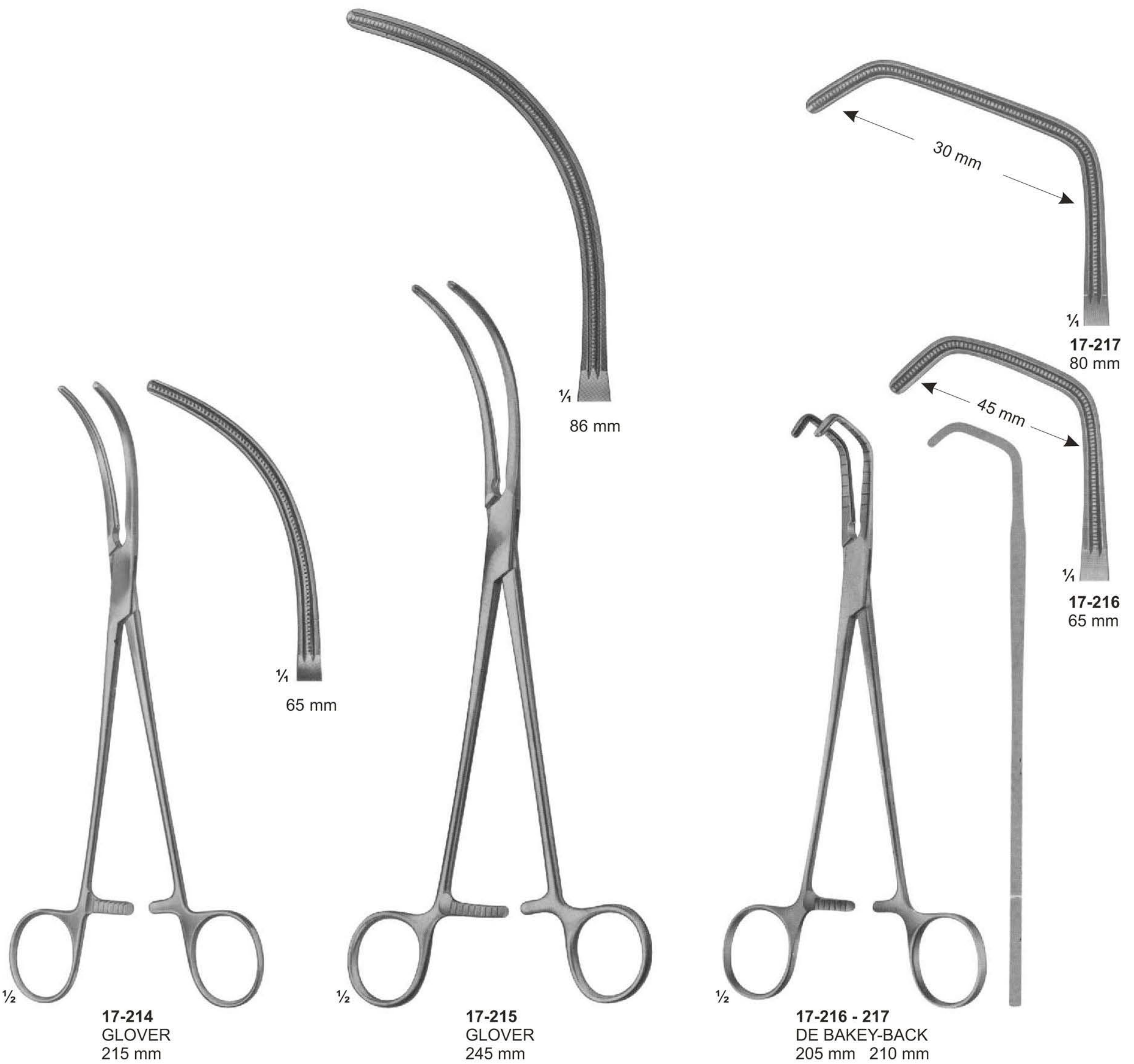



# Vena-Cava Clamps

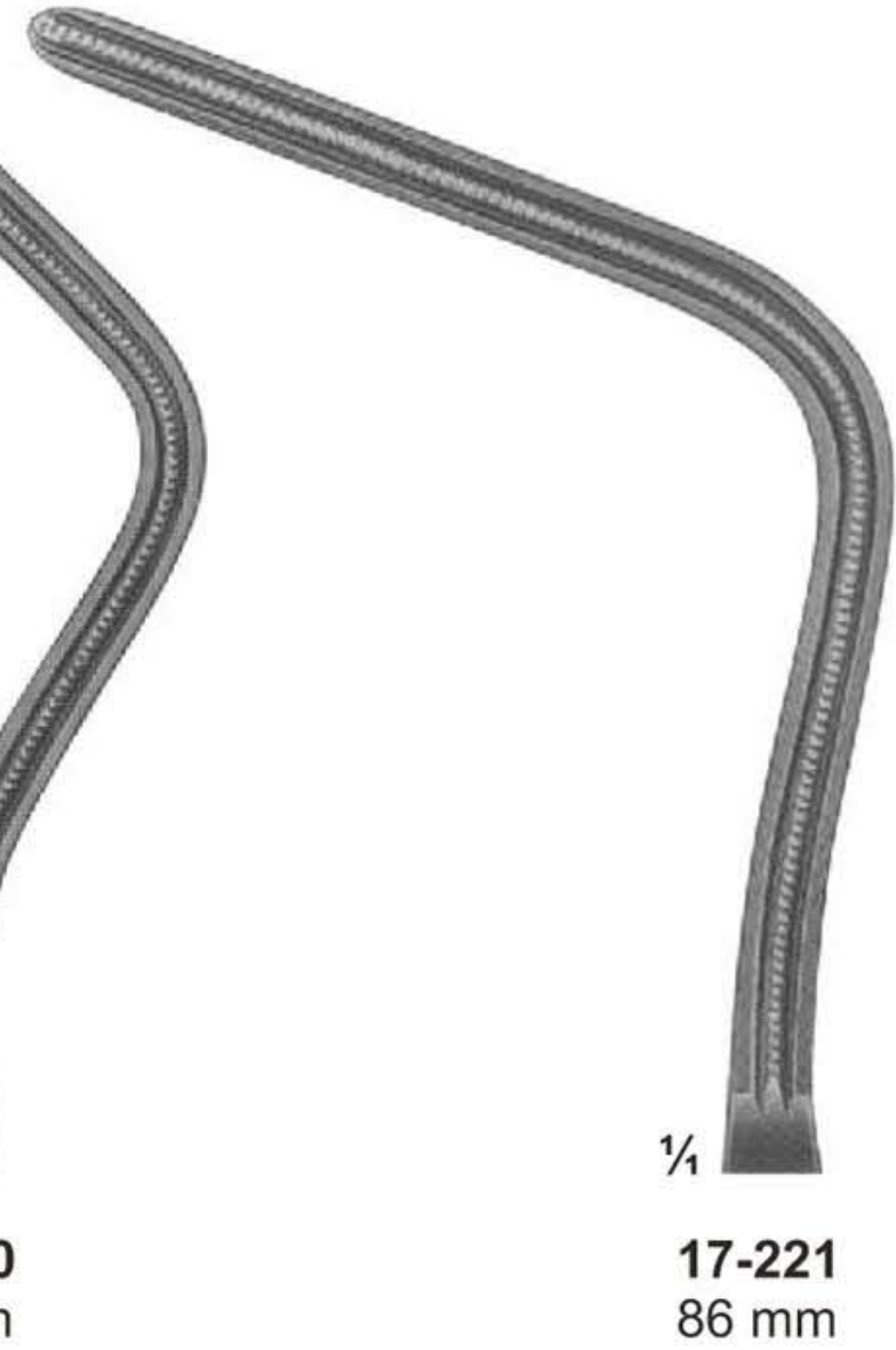
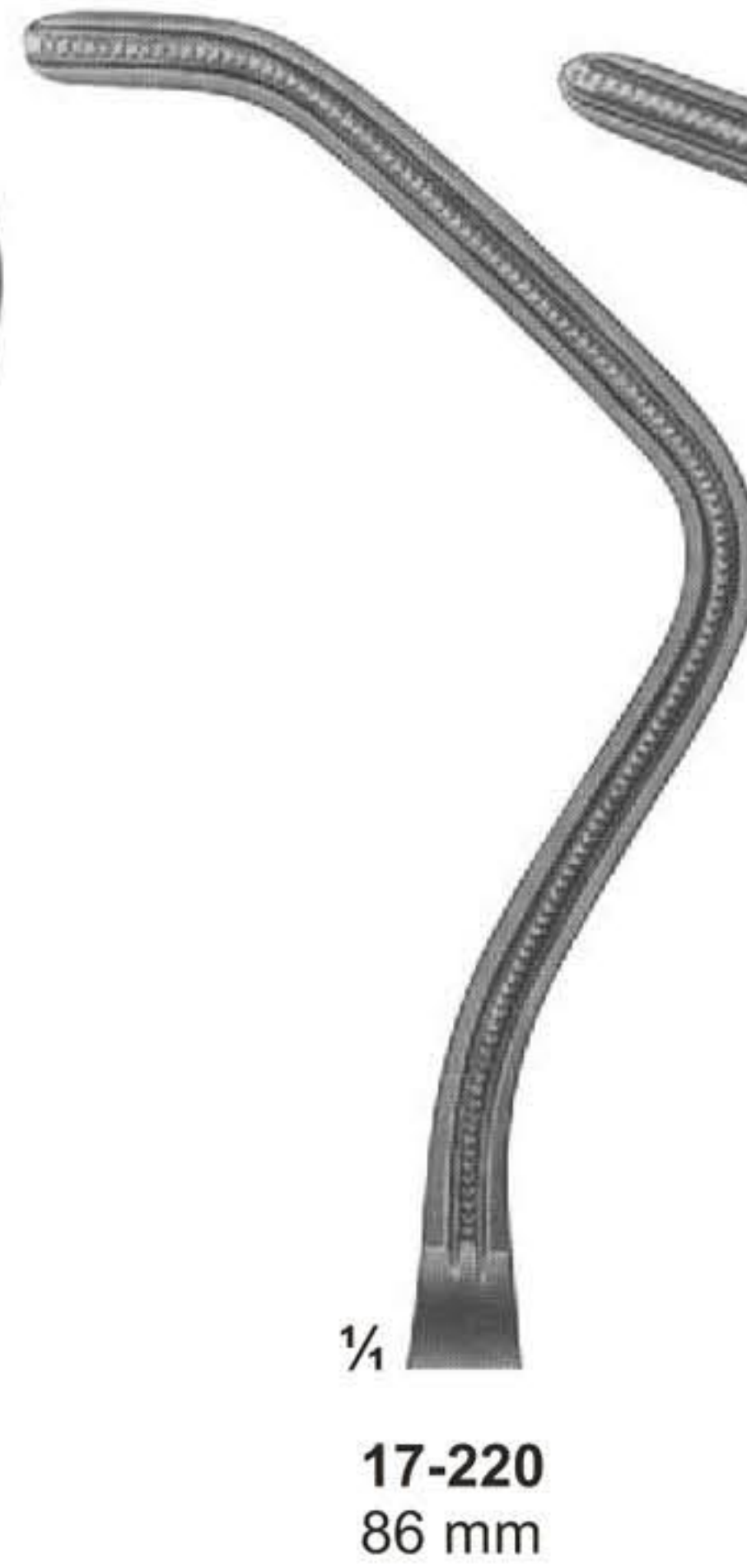

**17-218 - 221**  
DE BAKEY-HARKEN  
17-218 - 255 mm  
17-219 - 245 mm  
17-220 - 245 mm  
17-221 - 245 mm

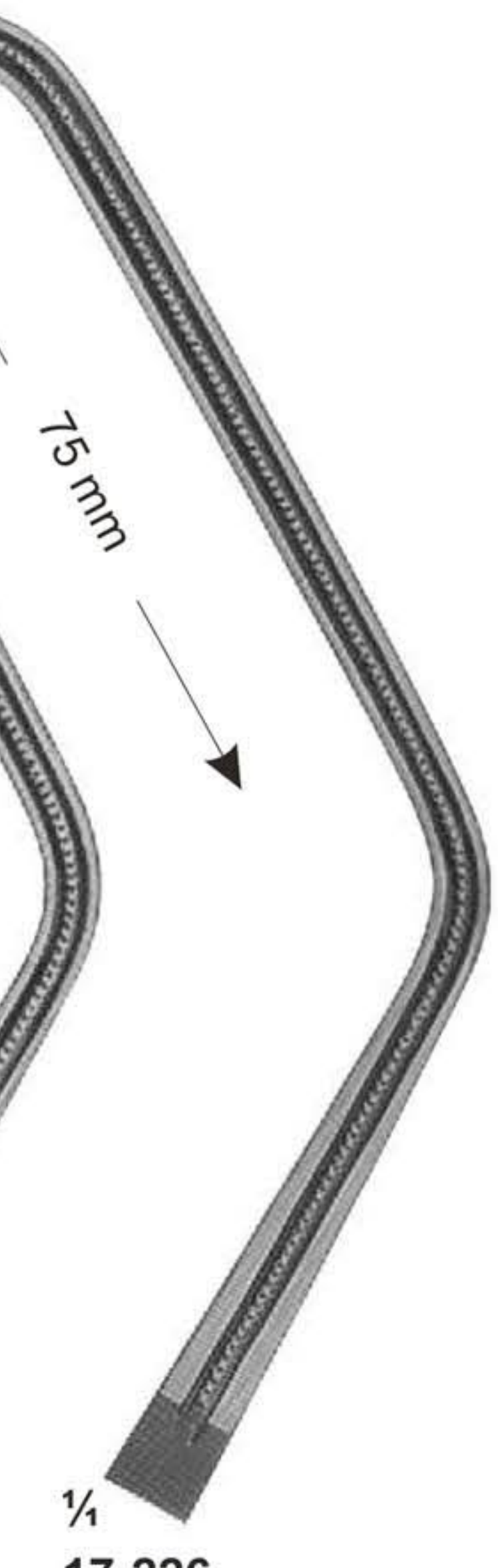
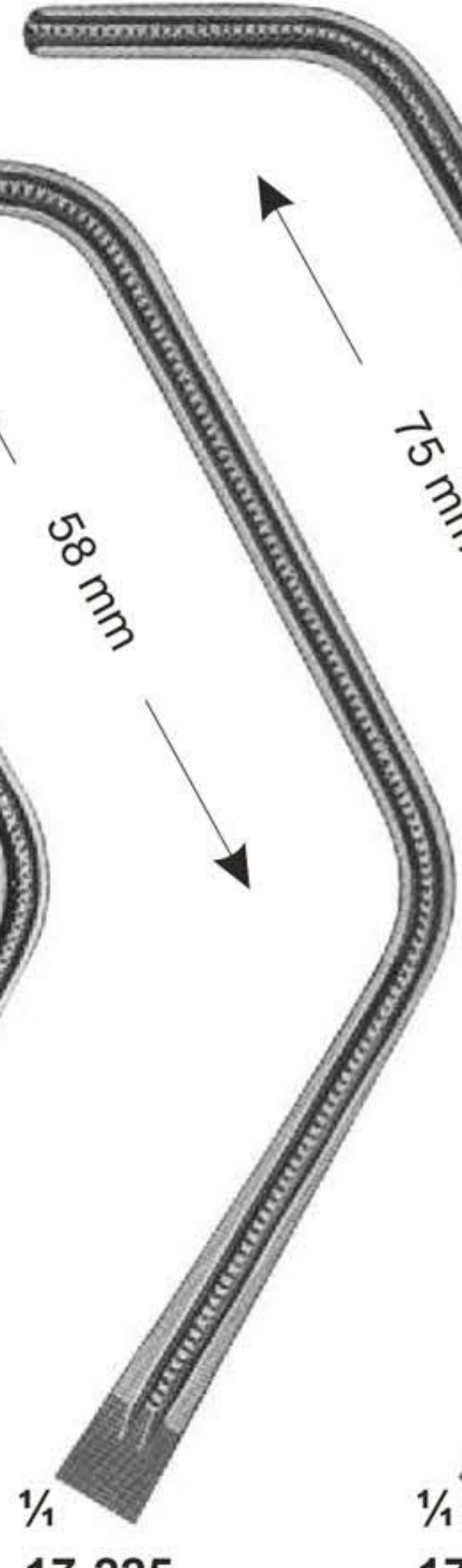
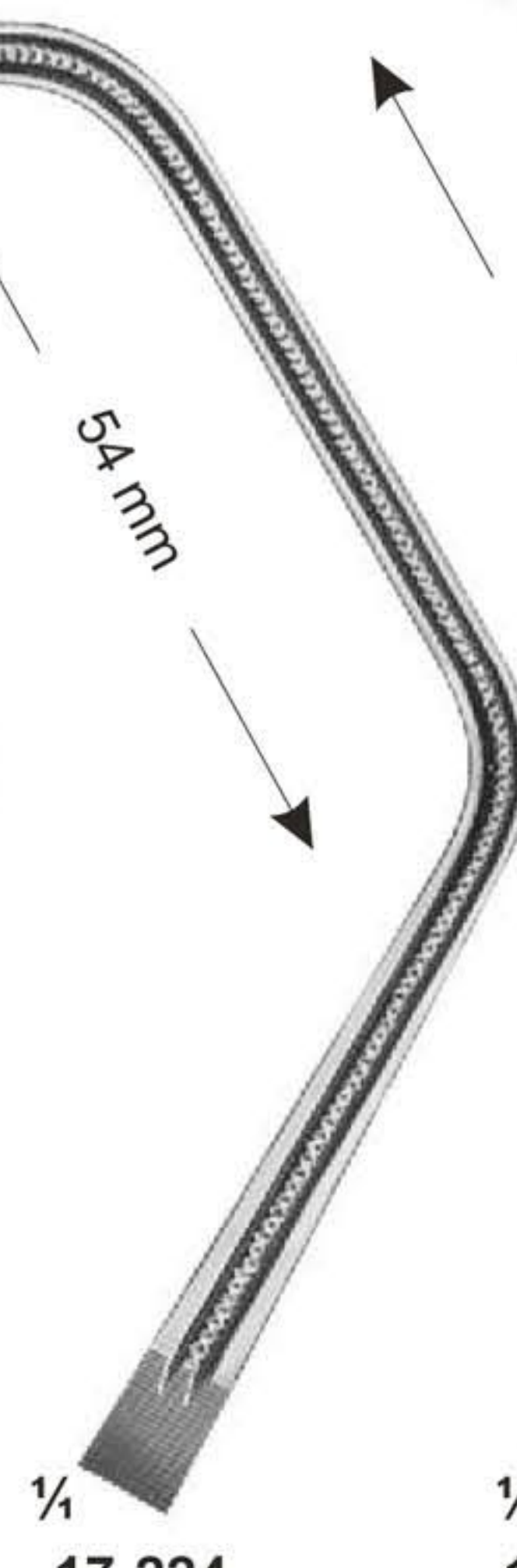
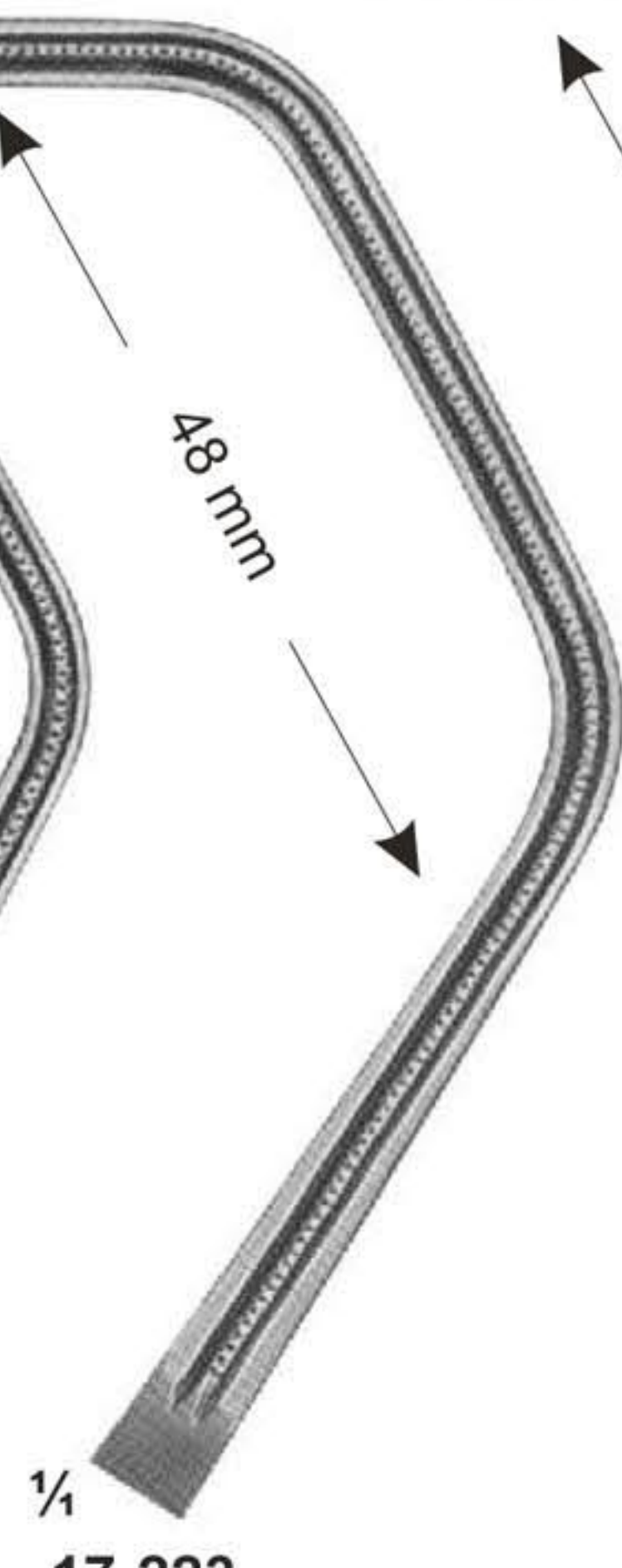
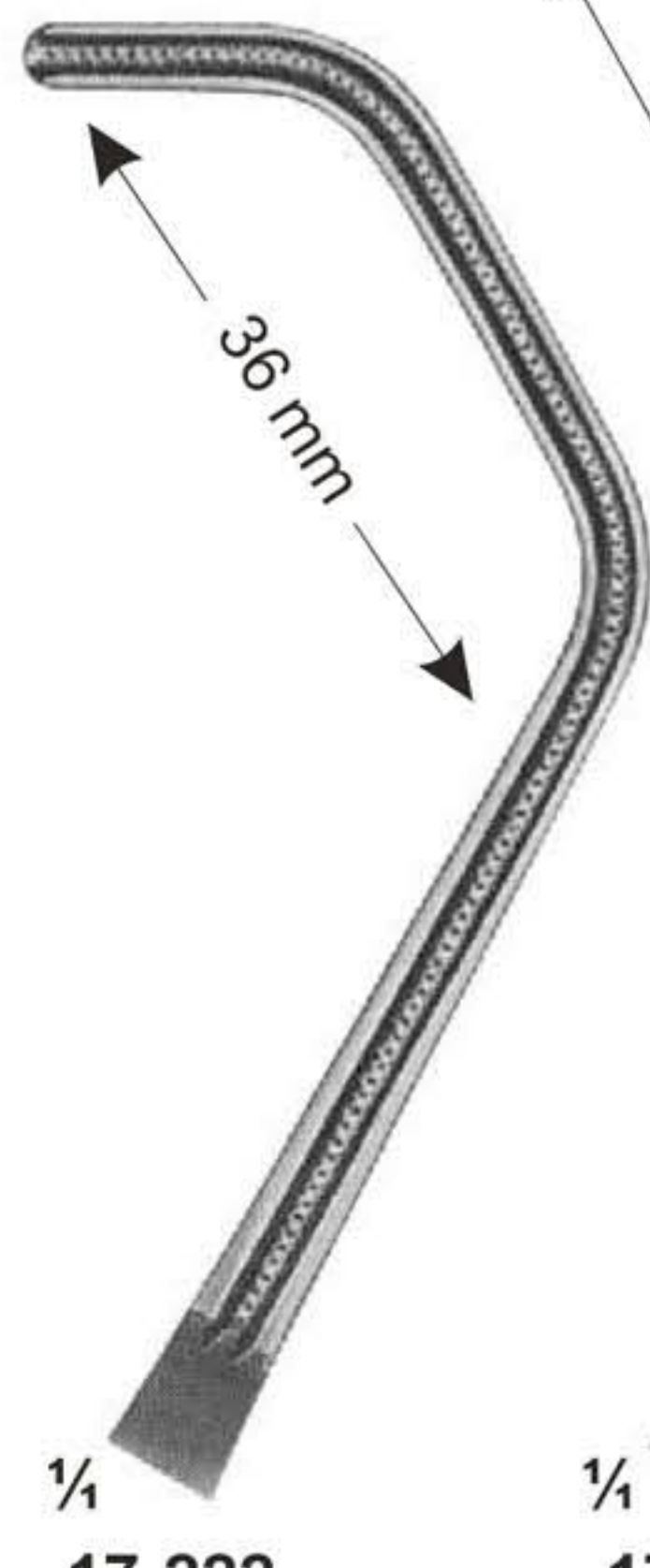

**17-222 - 226**  
DE BAKEY  
Total Length: 220 mm  
Length of jaws: 85 mm

**17-222**  
220 mm

**17-223**  
256 mm

**17-224**  
270 mm

**17-225**  
270 mm

**17-226**  
280 mm

85 mm

95 mm

99 mm

103 mm

119 mm



# Vena-Cava Clamps



**17-227 - 229**  
DE BAKEY-SATINSKY  
235 mm, 240 mm, 245 mm

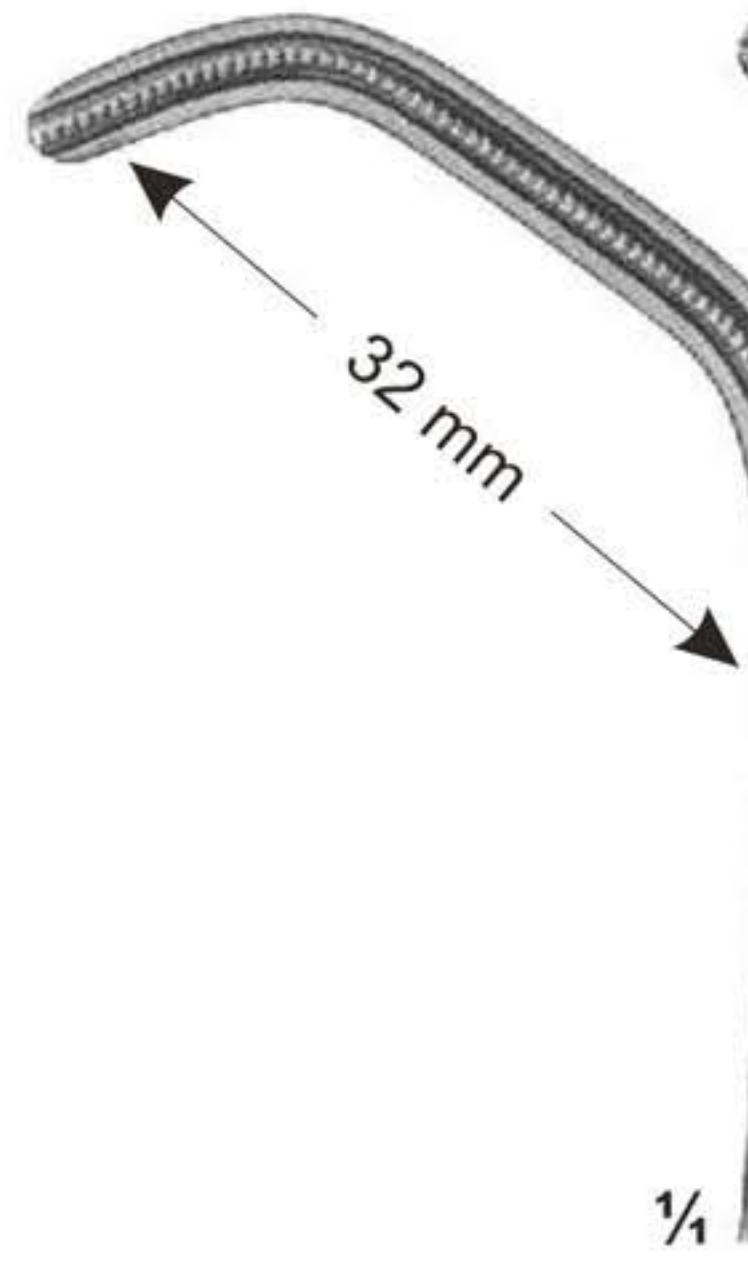

**17-227**  
68 mm

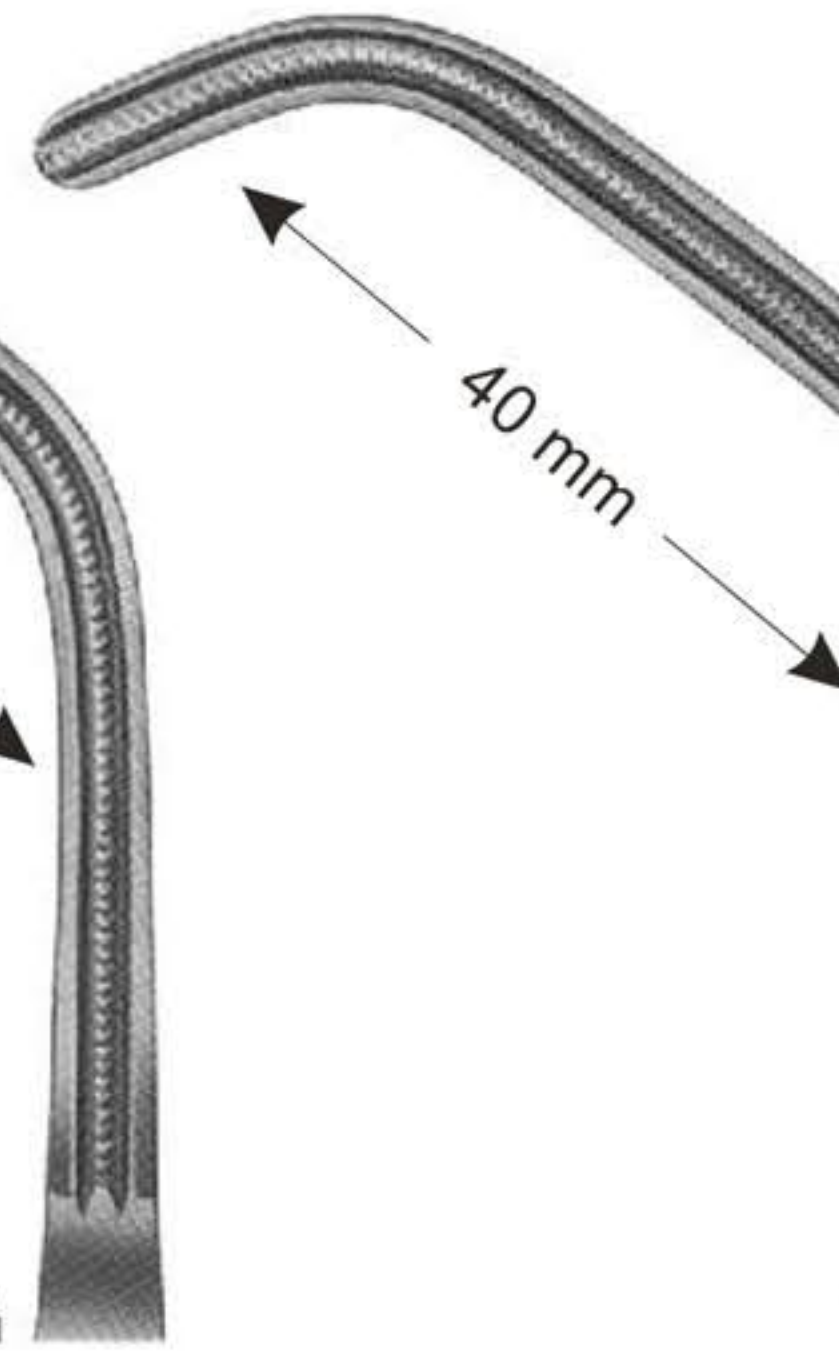

**17-228**  
76 mm

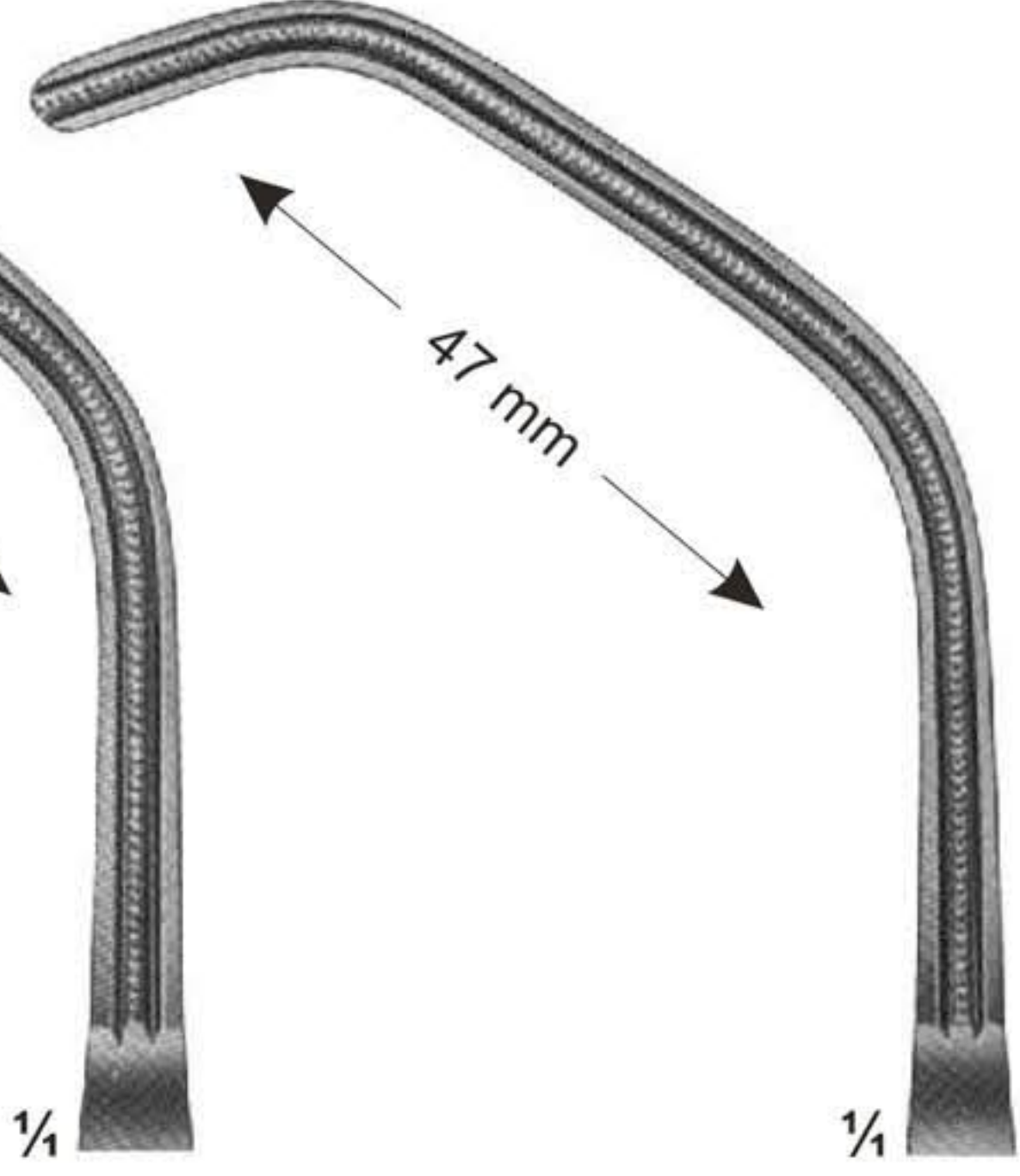

**17-229**  
84 mm

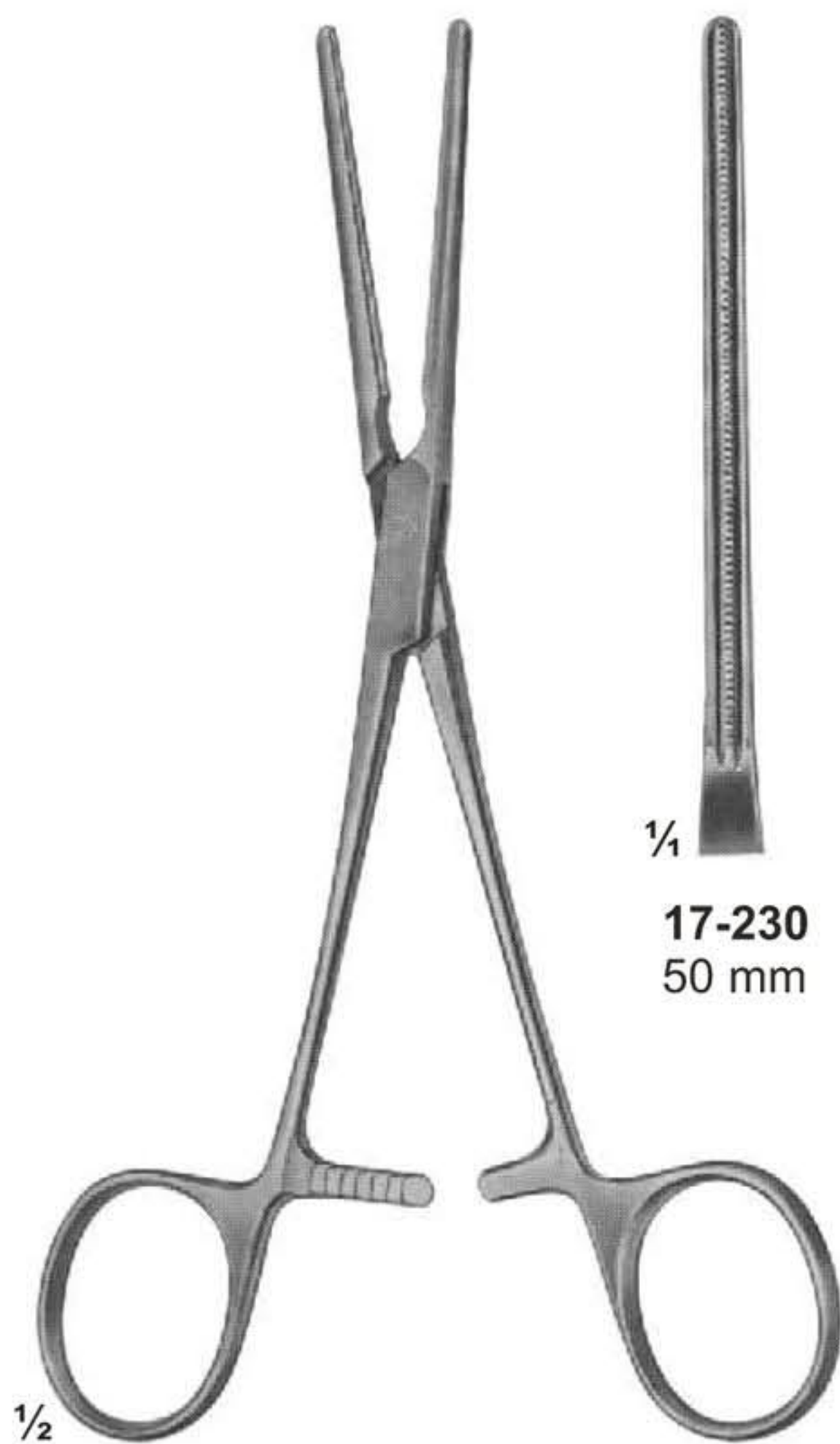

**17-230 - 231**  
DE BAKEY  
170 mm, 165 mm



**17-230**  
50 mm



**17-231**  
50 mm



**17-232**  
DE BAKEY  
165 mm



50 mm



**Vena-Cava Clamps**



**17-233 - 235**  
DE BAKY  
205 mm, 225 mm, 240 mm



**17-233** 41 mm  
**17-234** 65 mm  
**17-235** 80 mm



**17-236 - 238**  
DE BAKY  
200 mm, 225 mm, 240 mm



**17-236** 41 mm  
**17-237** 65 mm  
**17-238** 80 mm

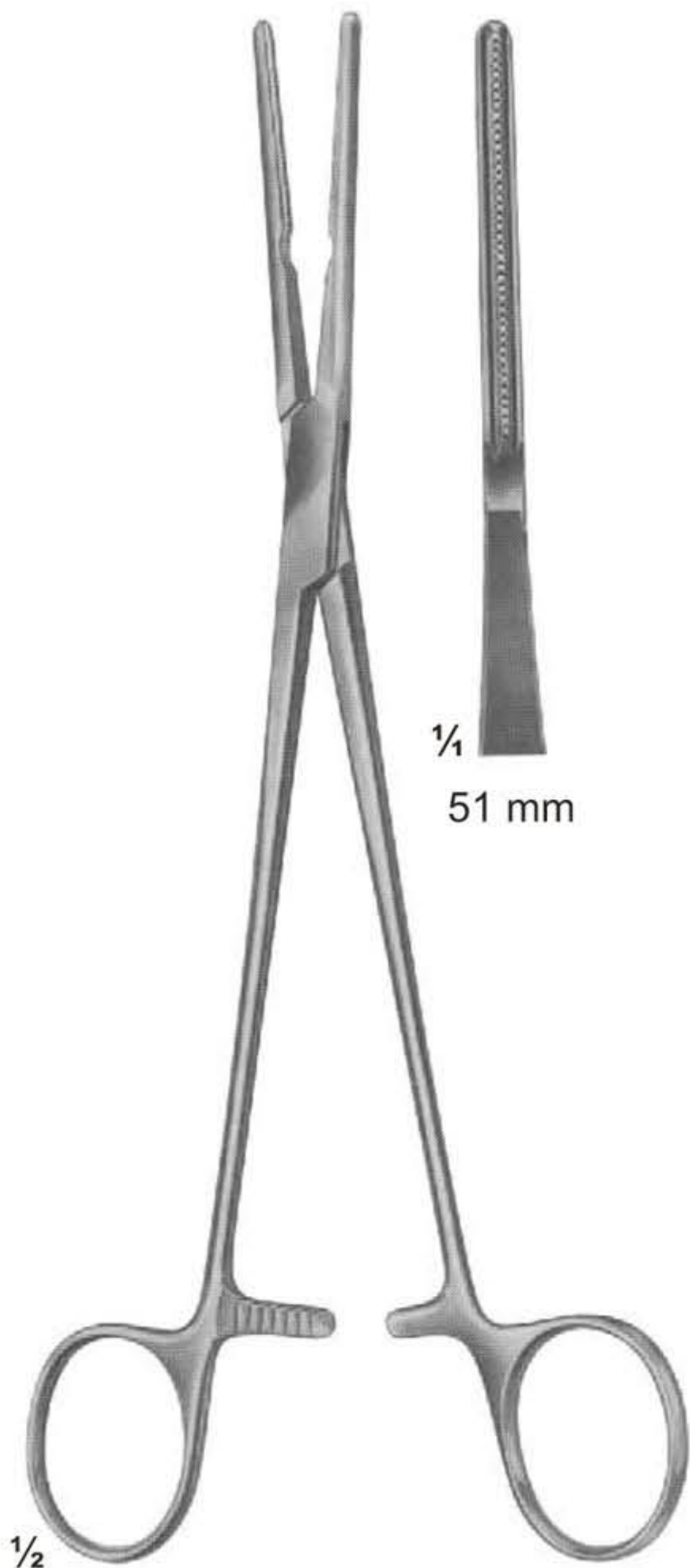

**17-239**  
DE BAKY  
210 mm



**1/4**  
51 mm



**17-240**  
DE BAKY  
210 mm

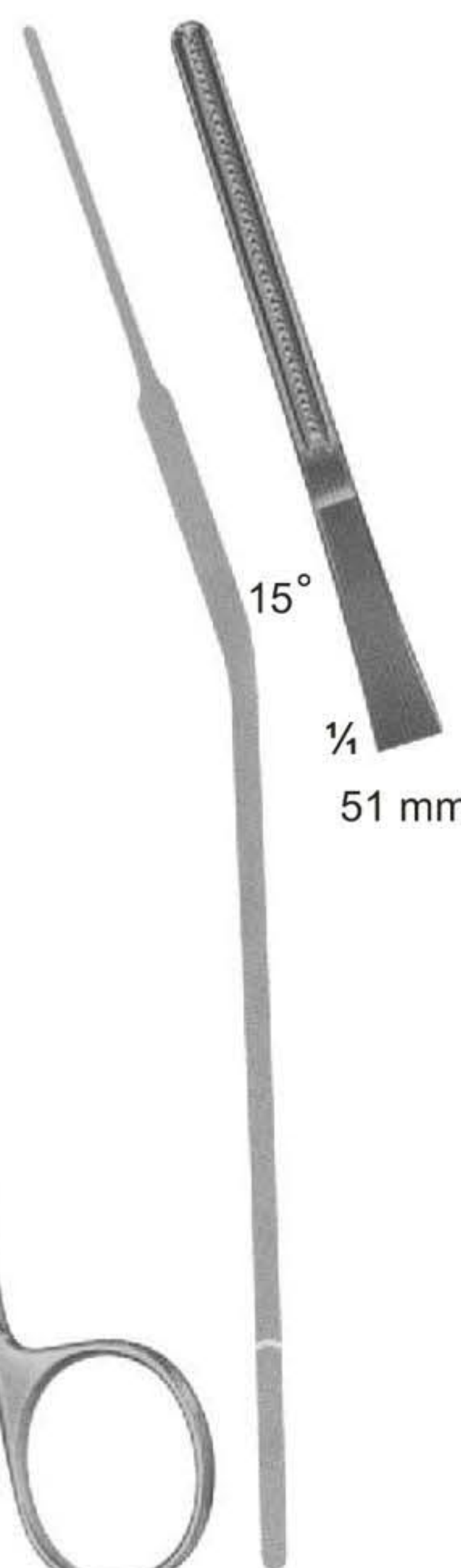

15°  
**1/4**  
51 mm



**17-241**  
DE BAKY  
160 mm

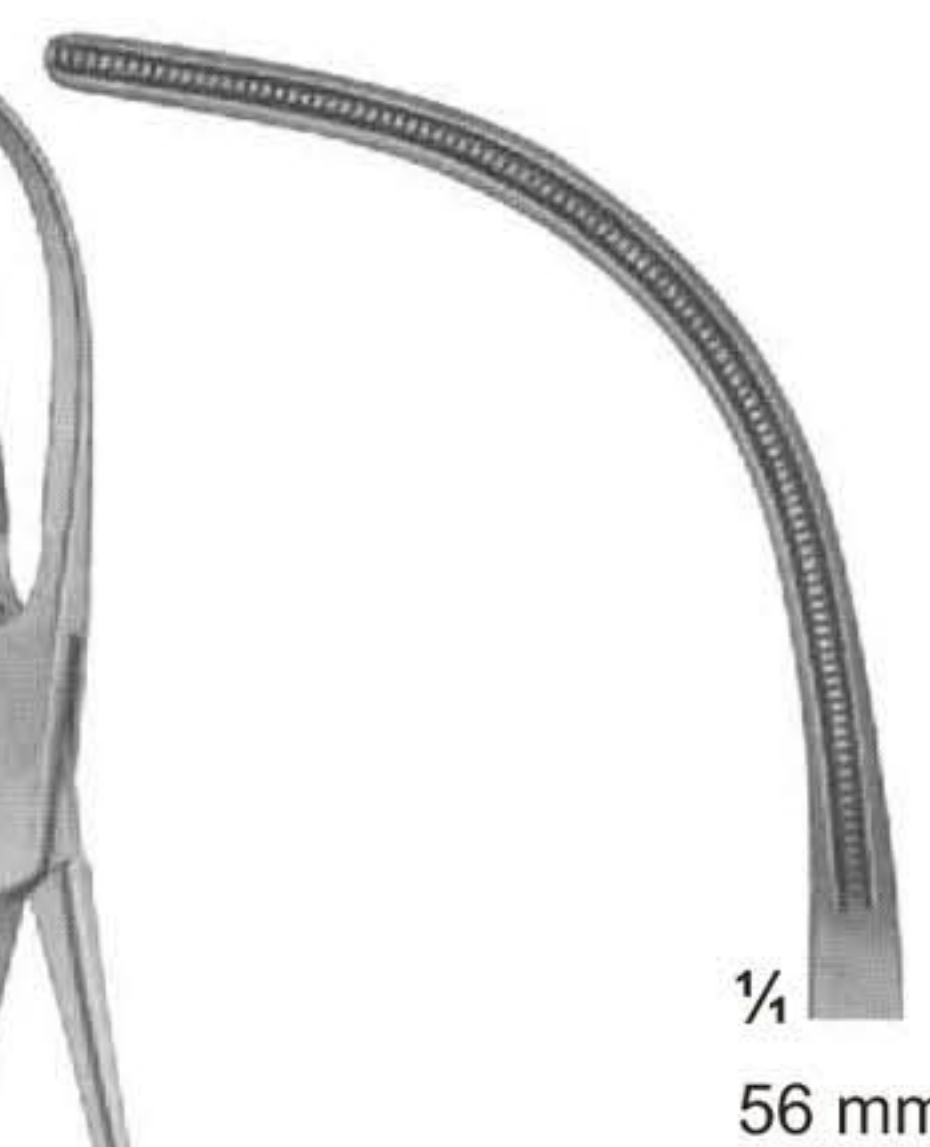

**1/4**  
56 mm



Vena-Cava Clamps

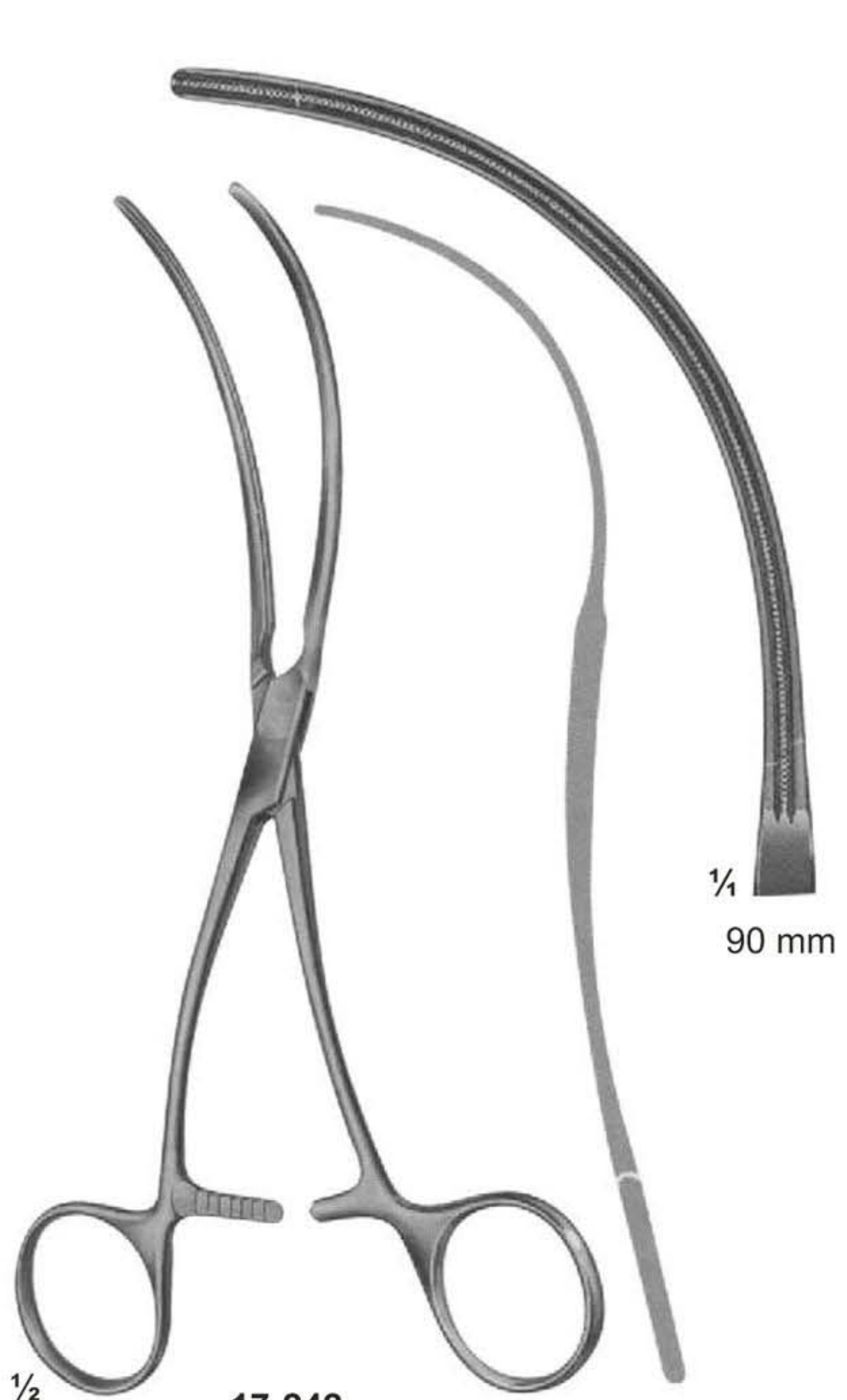

**17-242**  
DE BAKEY  
190 mm

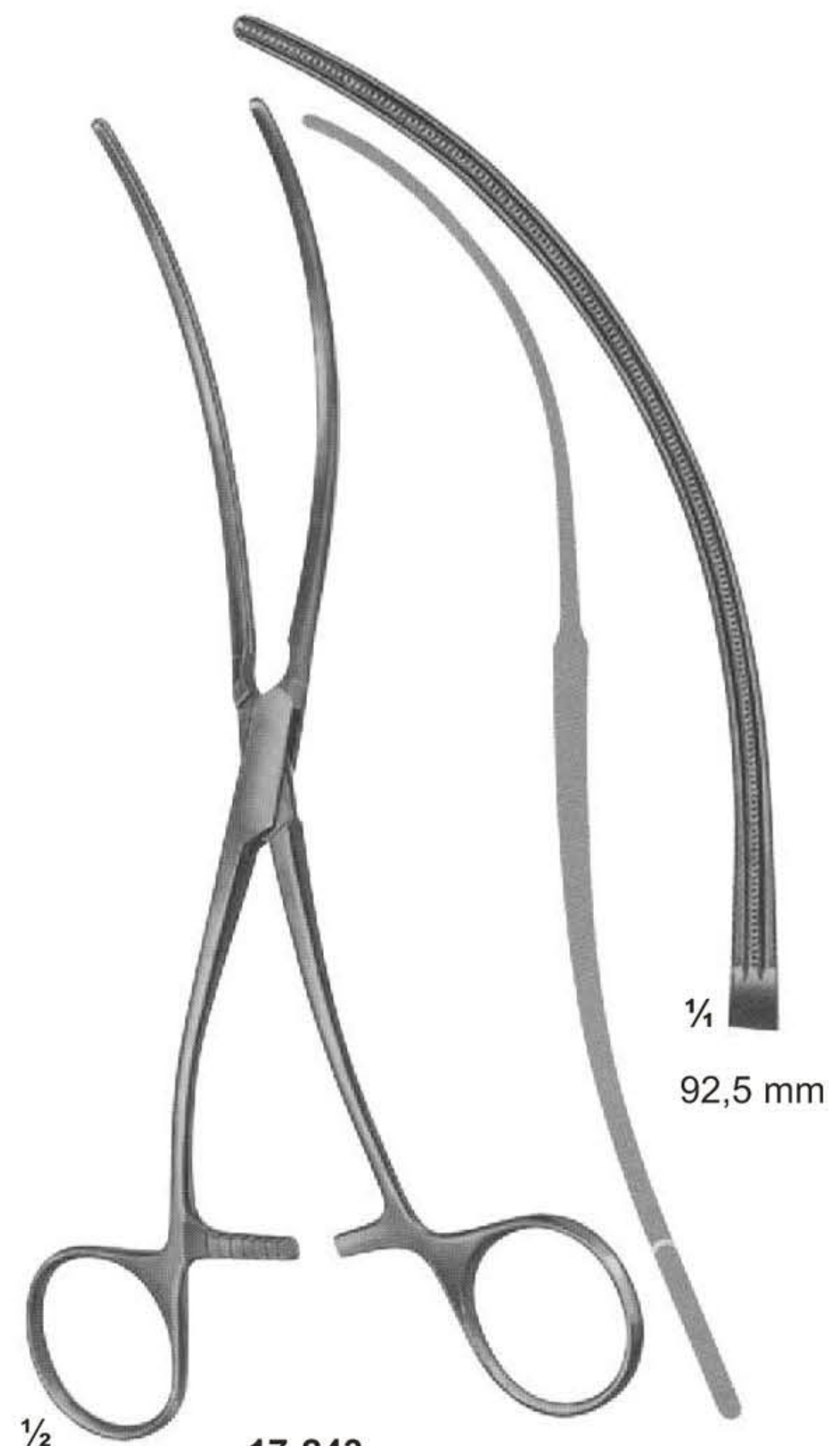

**17-243**  
DE BAKEY  
200 mm

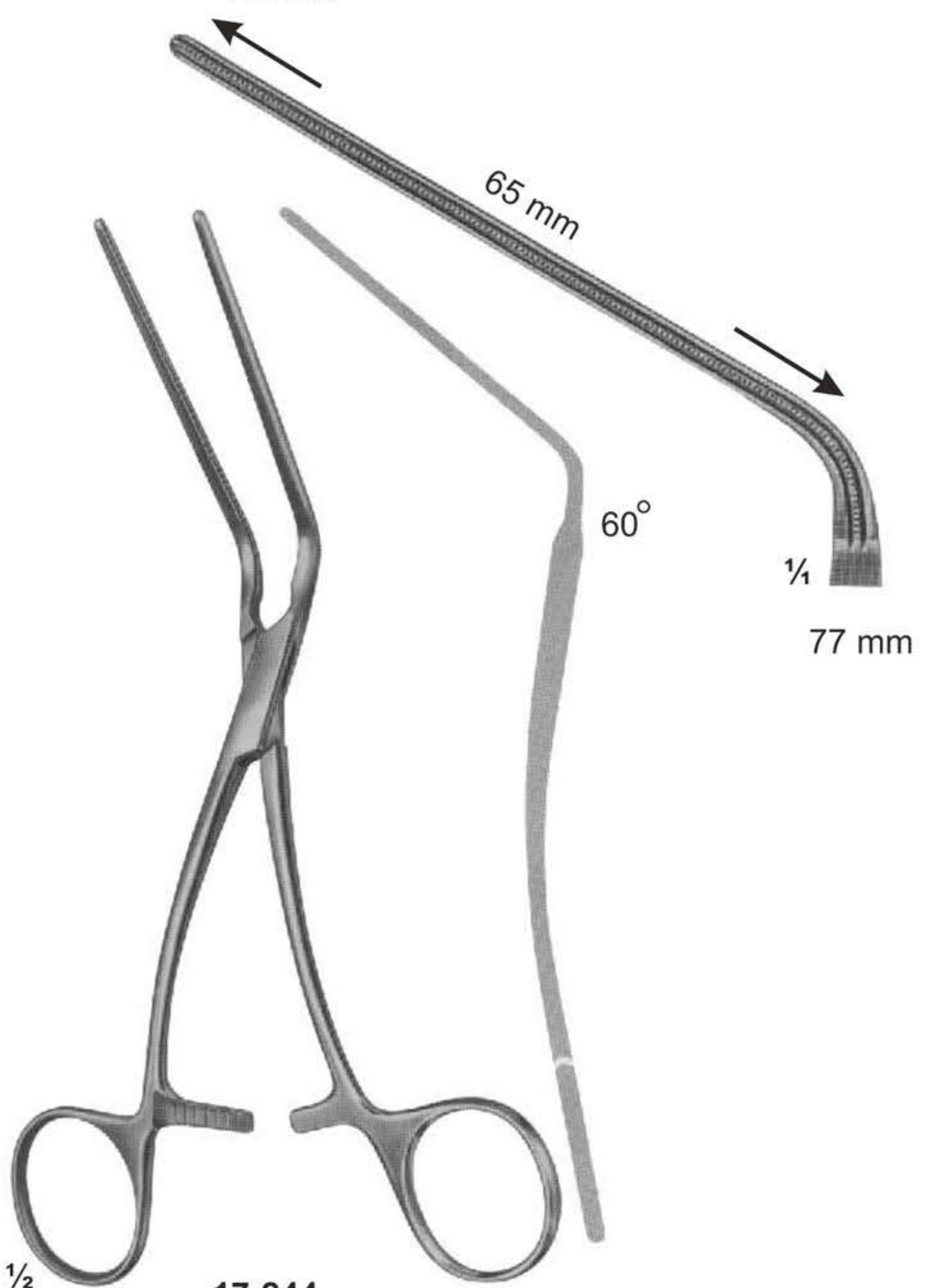

**17-244**  
DE BAKEY  
180 mm

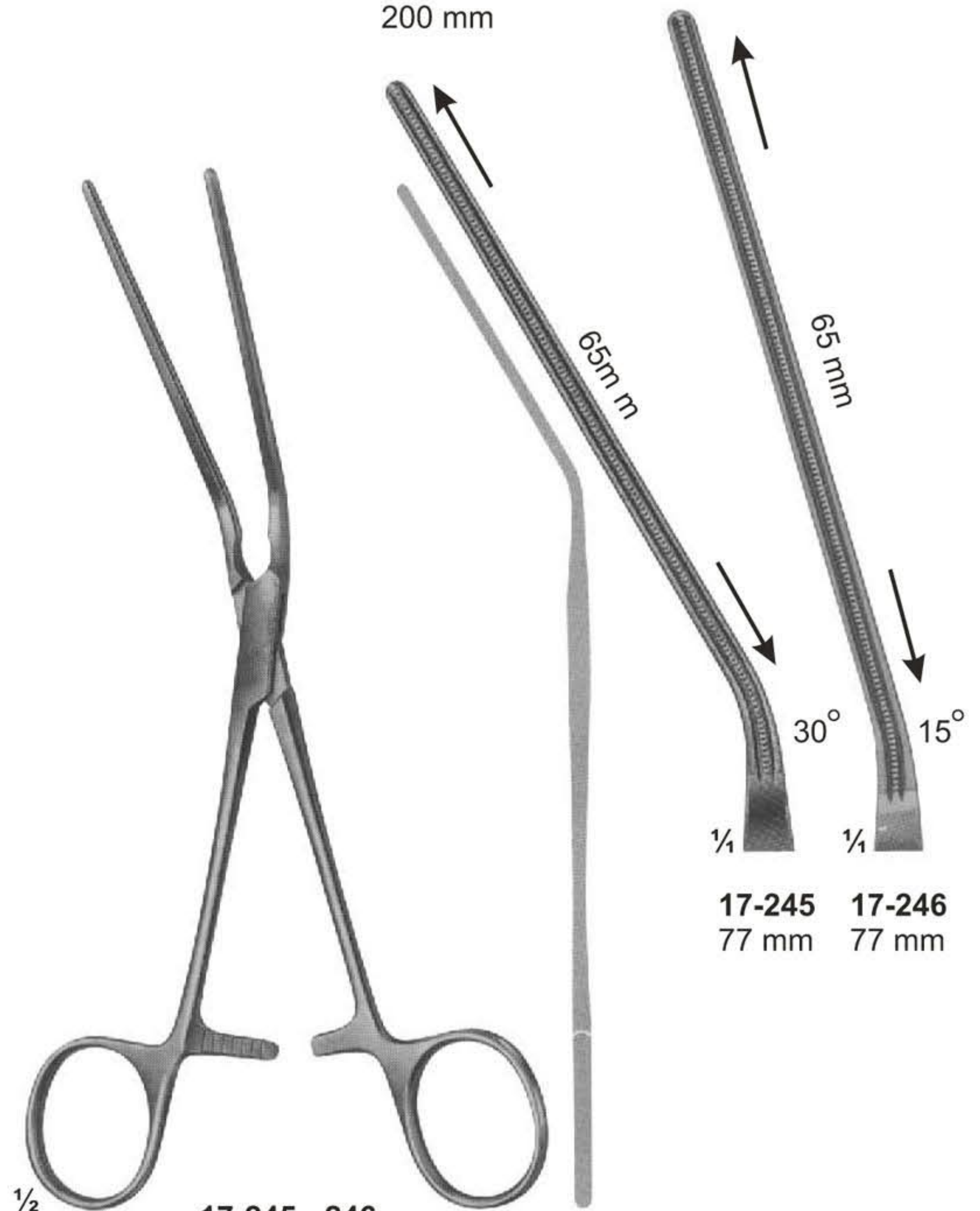

**17-245 - 246**  
DE BAKEY  
190 mm

**17-245** 77 mm  
**17-246** 77 mm



# Vena-Cava Clamps

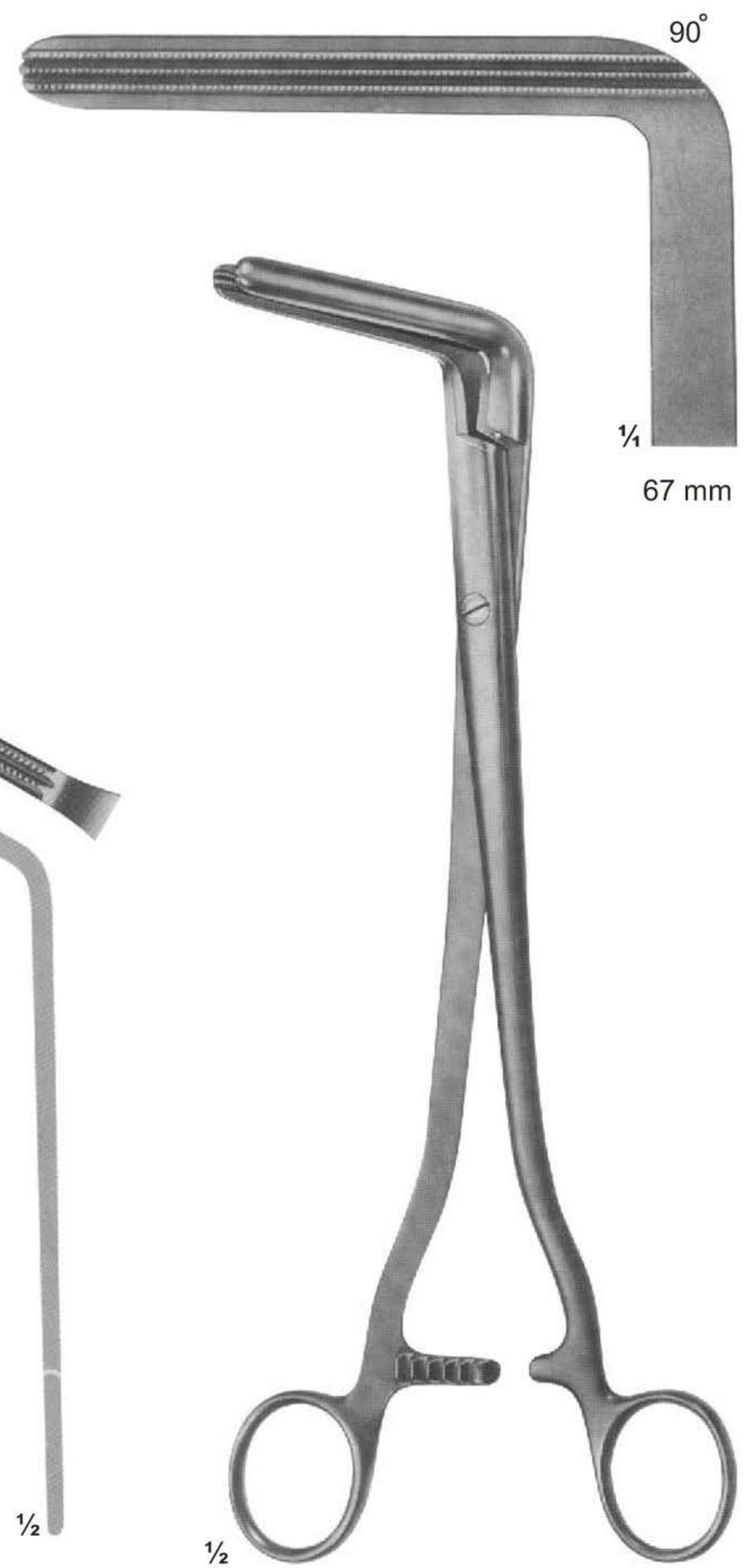



Vena-Cava Clamps

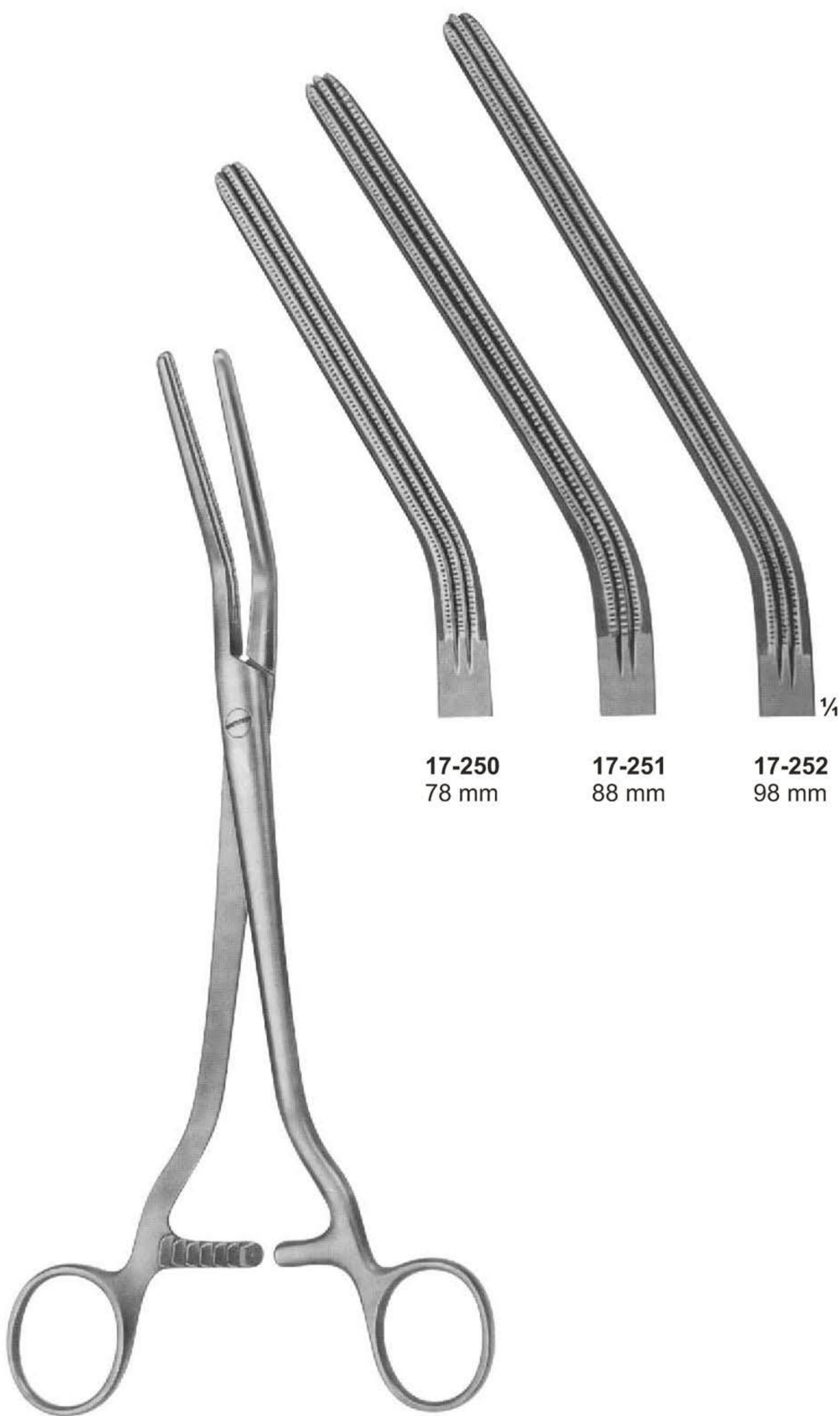

**17-250 - 252**  
DICK  
255 mm, 265 mm, 275 mm

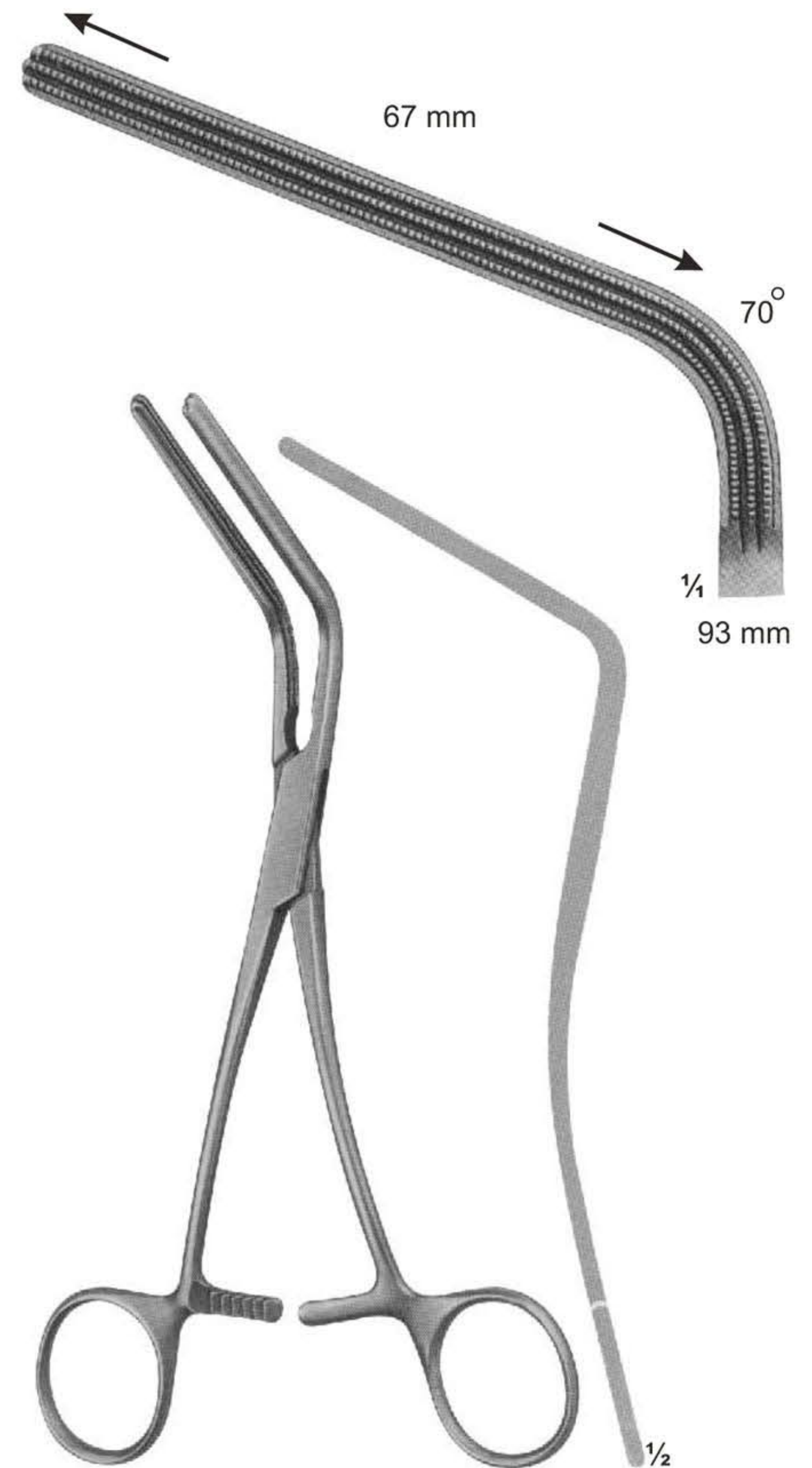

**17-253**  
MORRIS  
175 mm



Vena-Cava Clamps

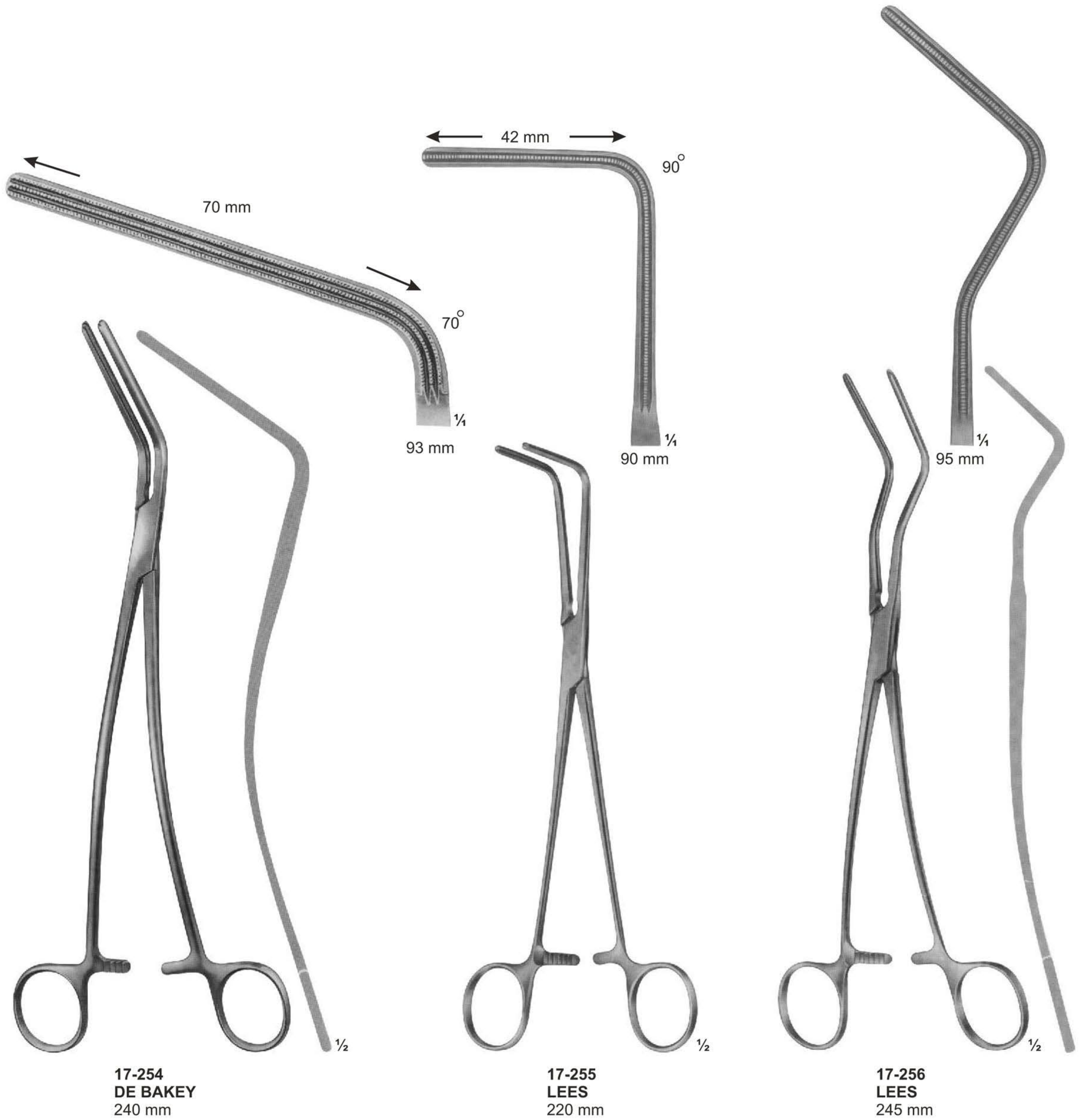



Vena-Cava Clamps

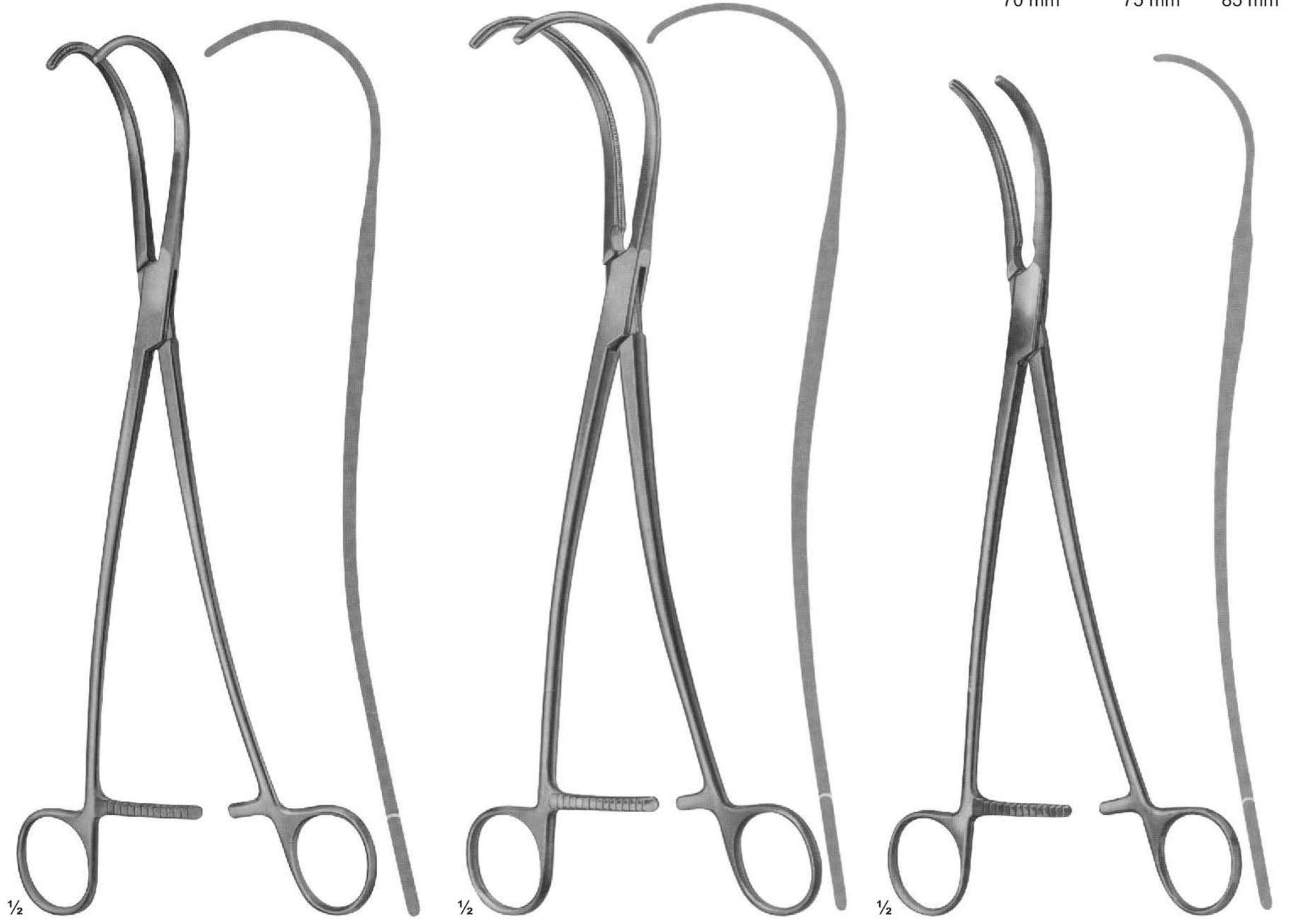
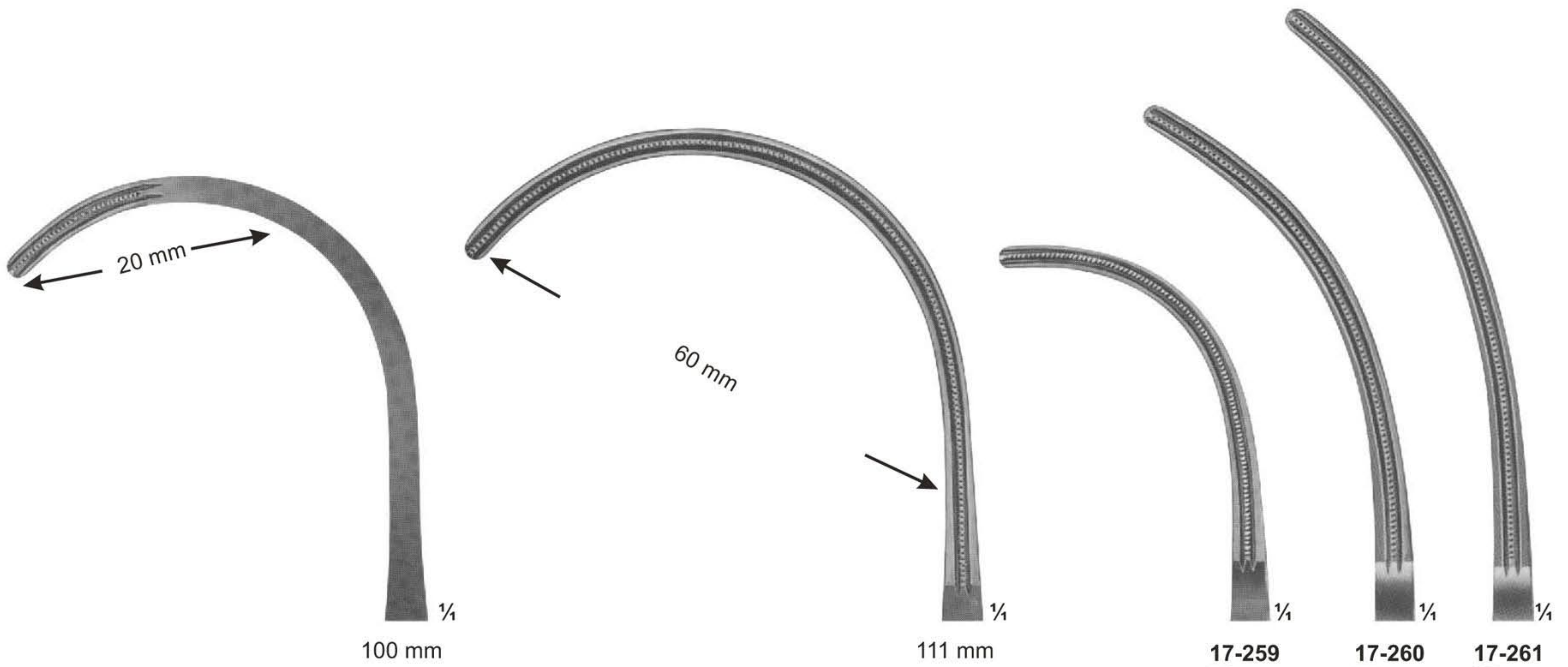

**17-257**  
**DE BAKEY**  
265 mm

**17-258**  
**DE BAKEY**  
270 mm

**17-259 - 261**  
**DE BAKEY**  
255 mm, 265 mm, 280 mm



# Vena-Cava Clamps

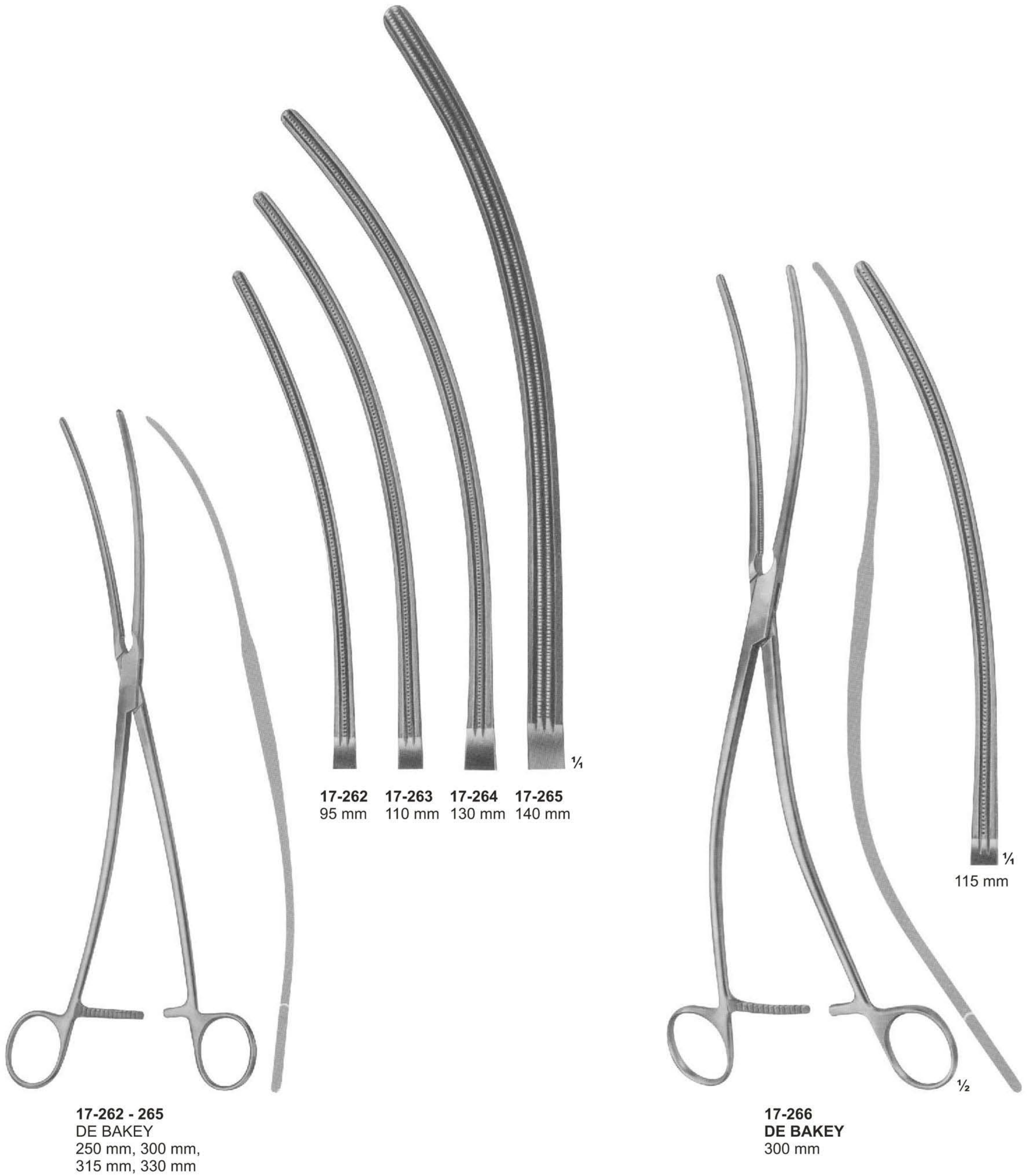



## Vena-Cava Clamps



**17-267  
DIETRICH**  
210 mm

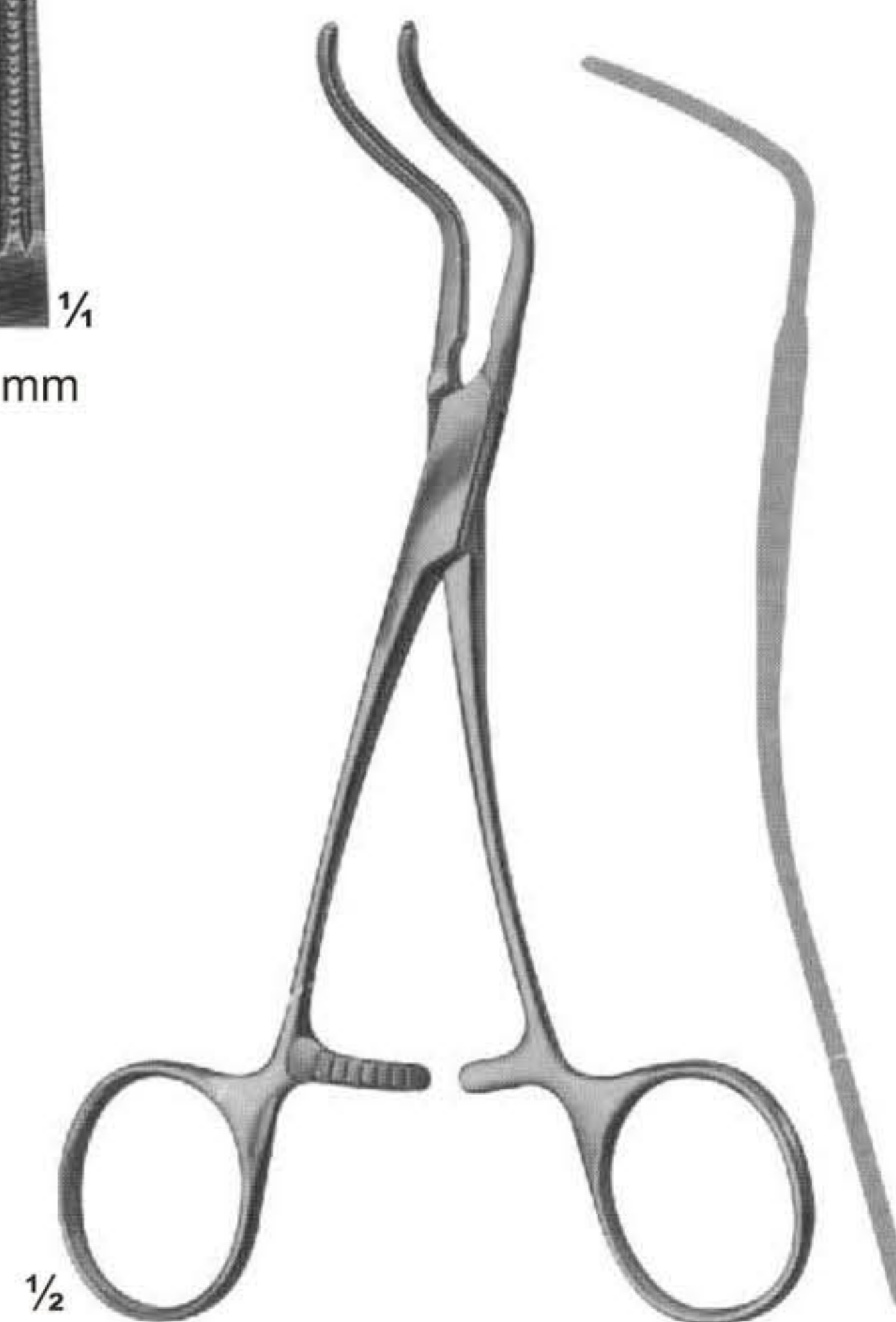

**17-268  
SUBRAMANIAN**  
155 mm

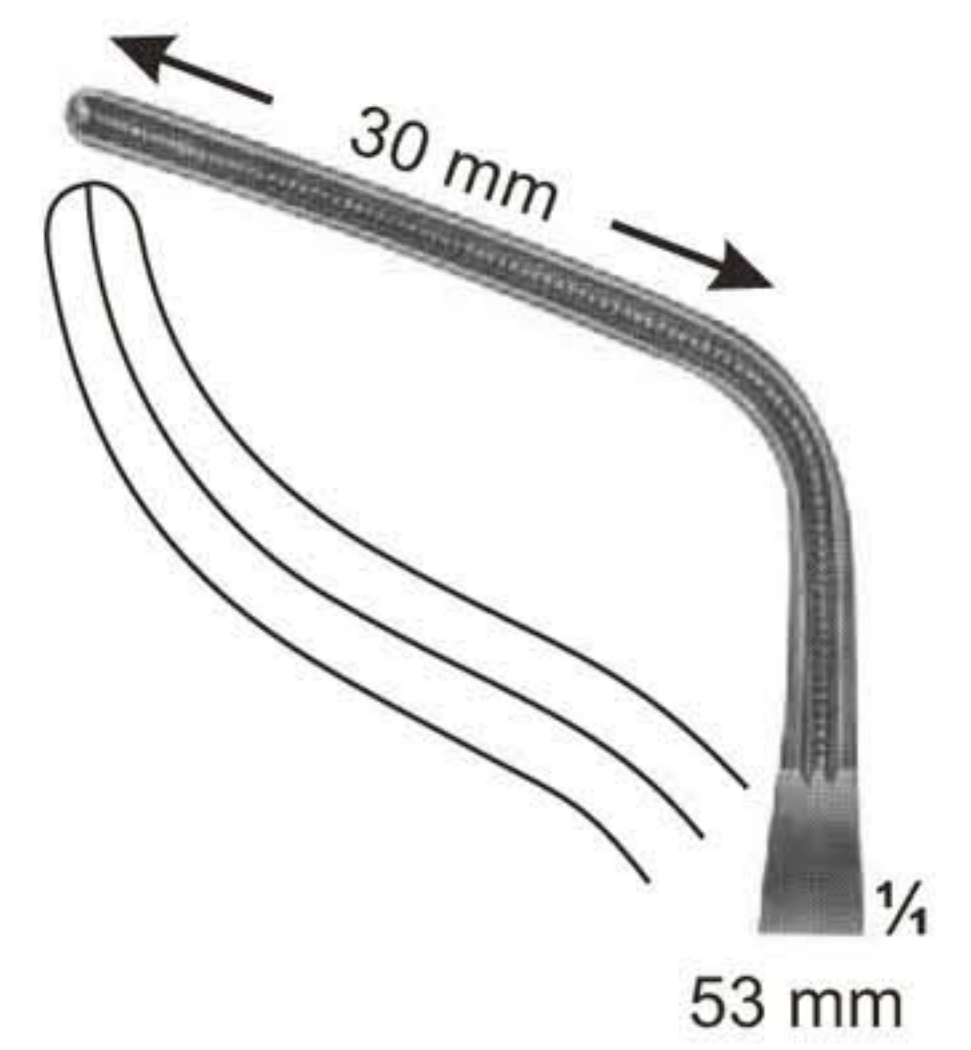



# Vena-Cava Clamps

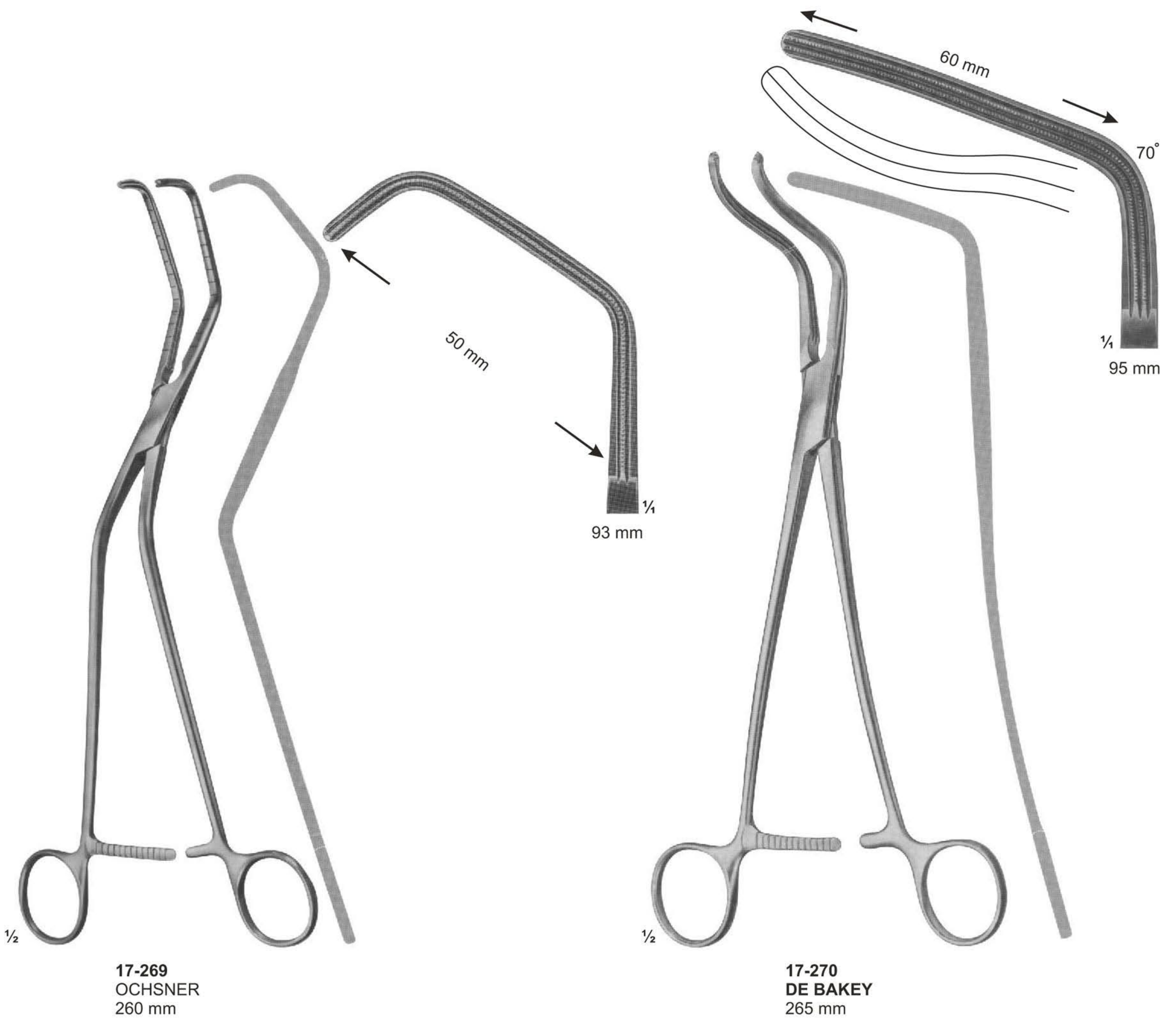



# Aorta-Anastomosis Clamps



**L**  
**17-271**  
WEBER  
265 mm



**R**  
**17-272**  
WEBER  
265 mm



**Aorta-Anastomosis Clamps**

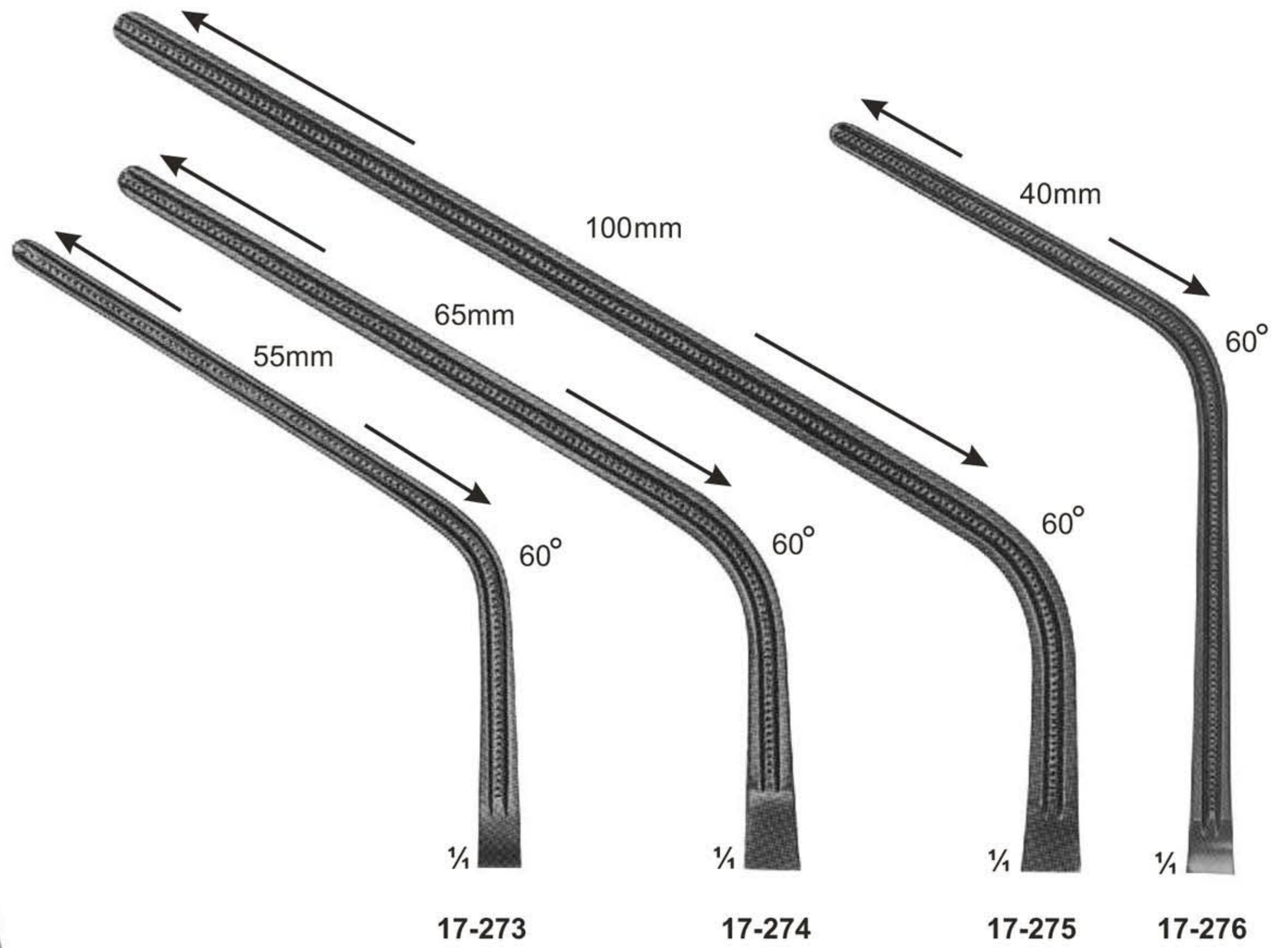

Total Length:	230 mm	280 mm	305 mm	240 mm
Length of jaws:	85 mm	100 mm	135 mm	93 mm

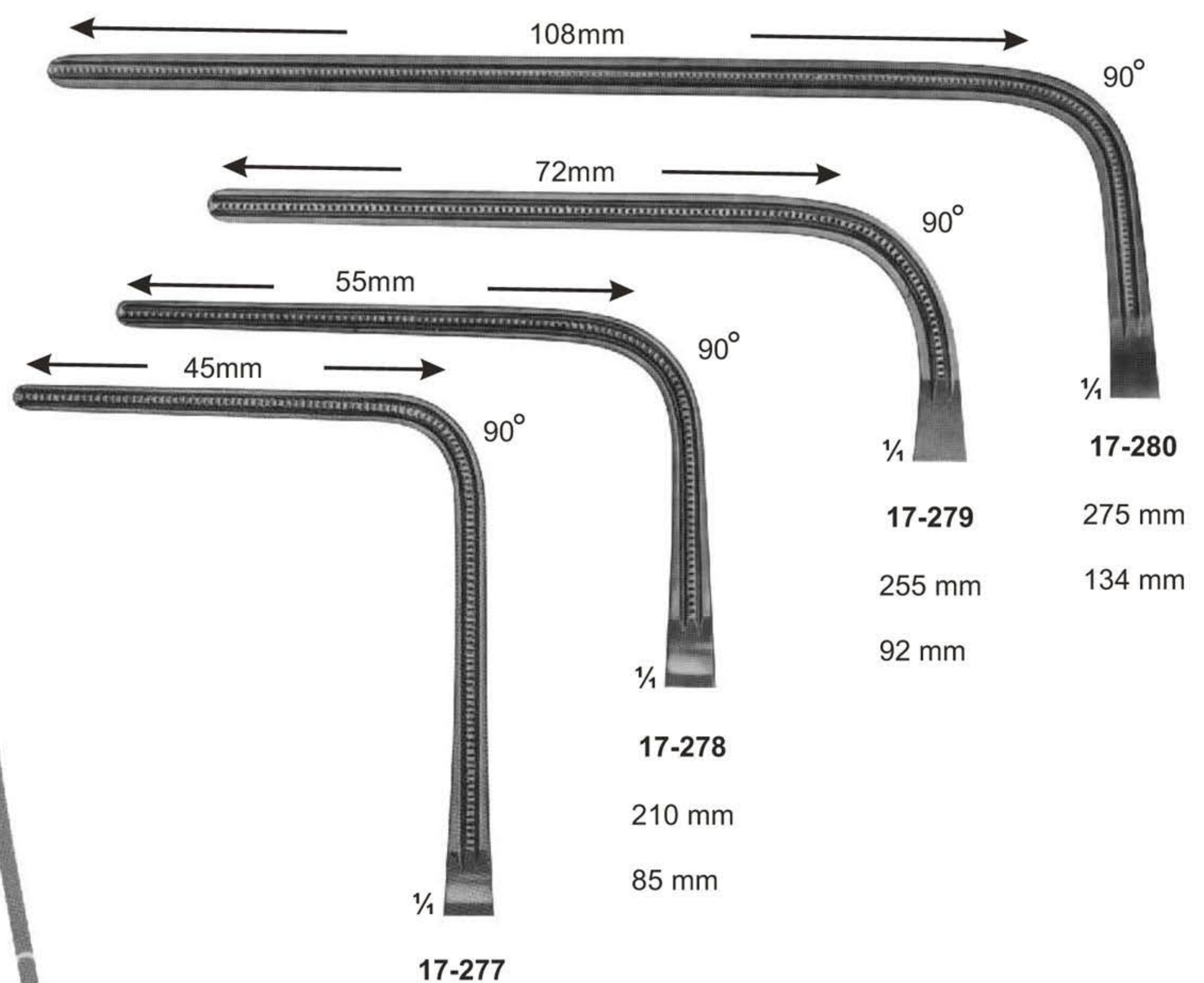

Total Length:	225 mm
Length of jaws:	93 mm



# Aorta-Anastomosis Clamps

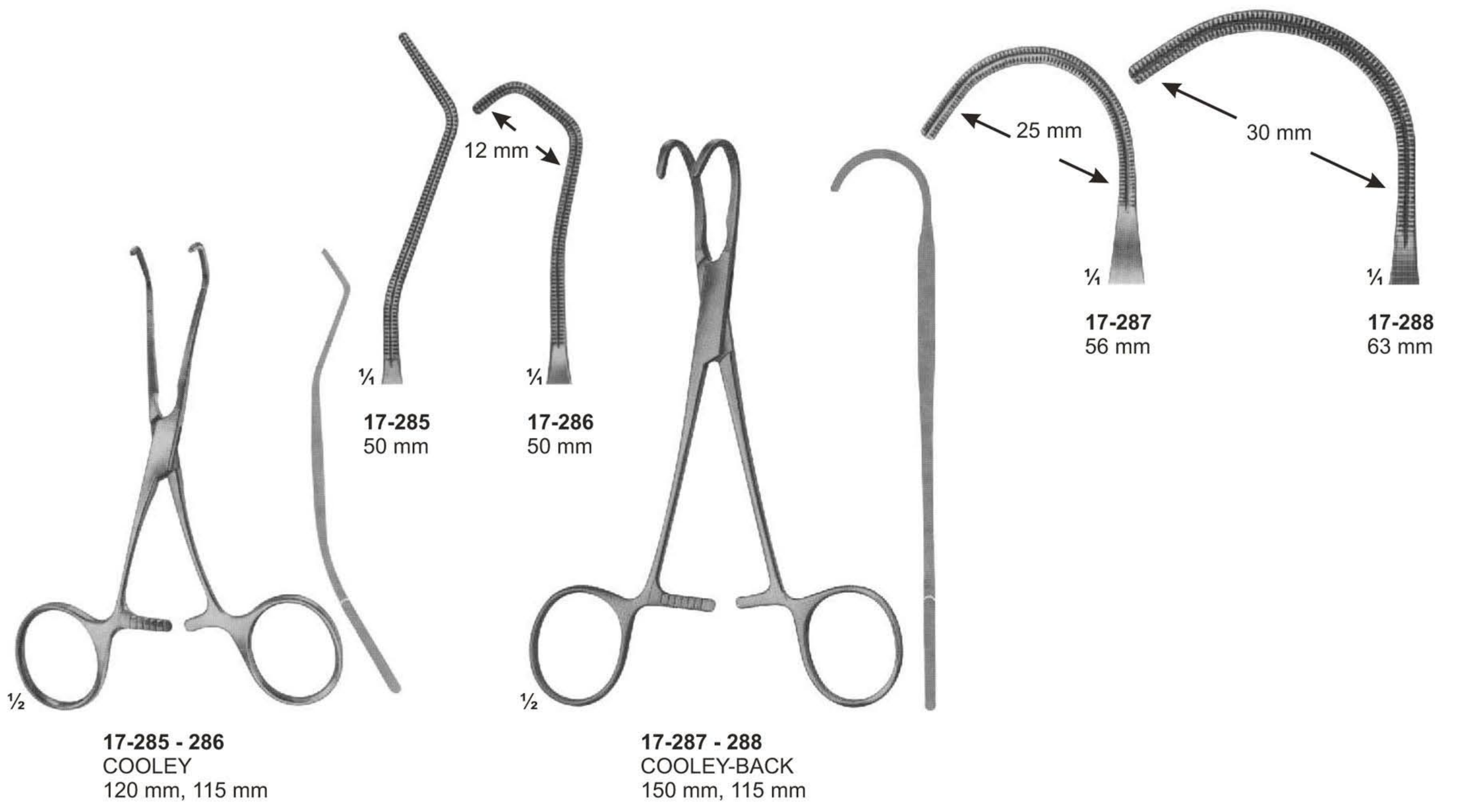
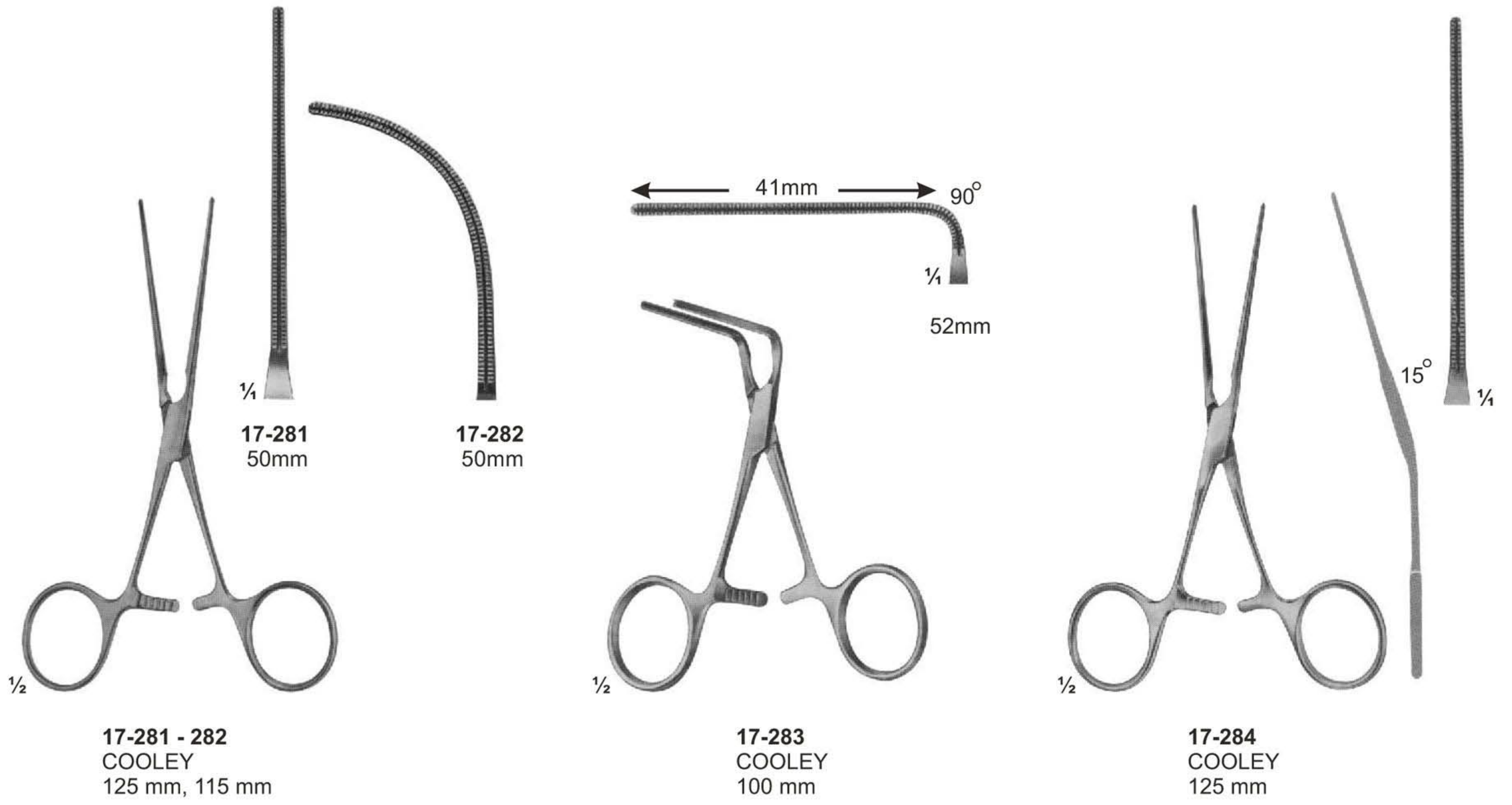



# Aorta-Anastomosis Clamps

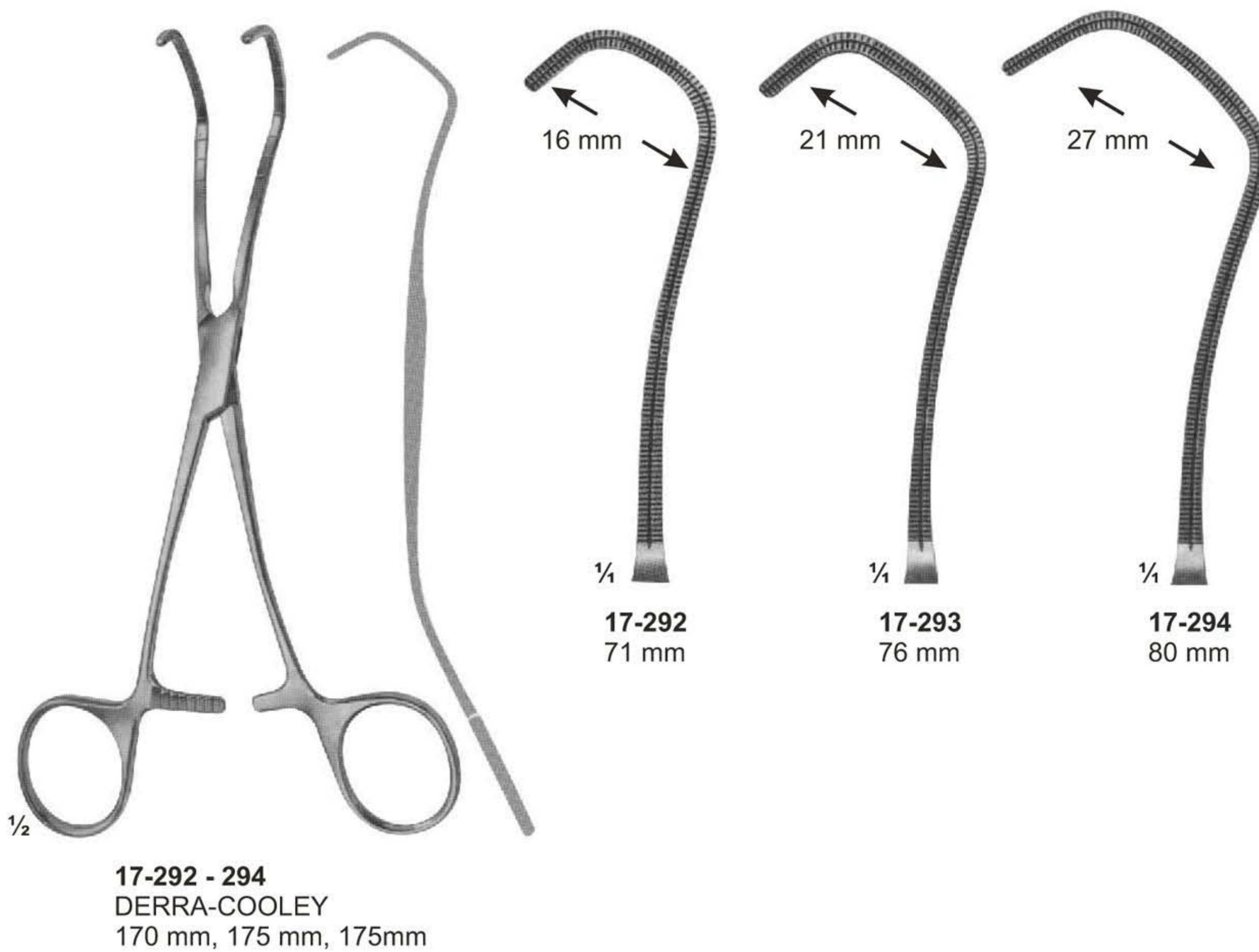
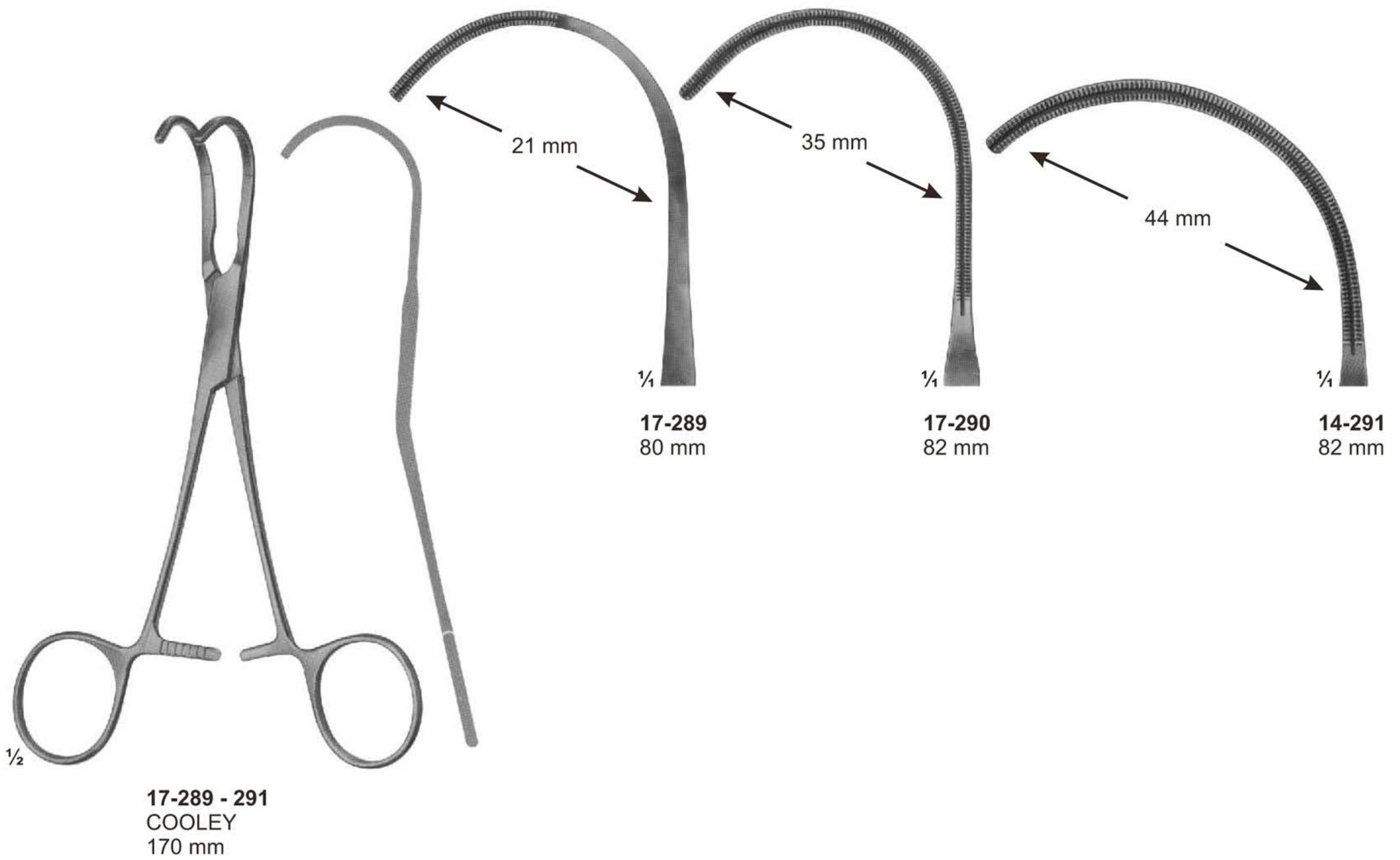



# Aorta-Anastomosis Clamps

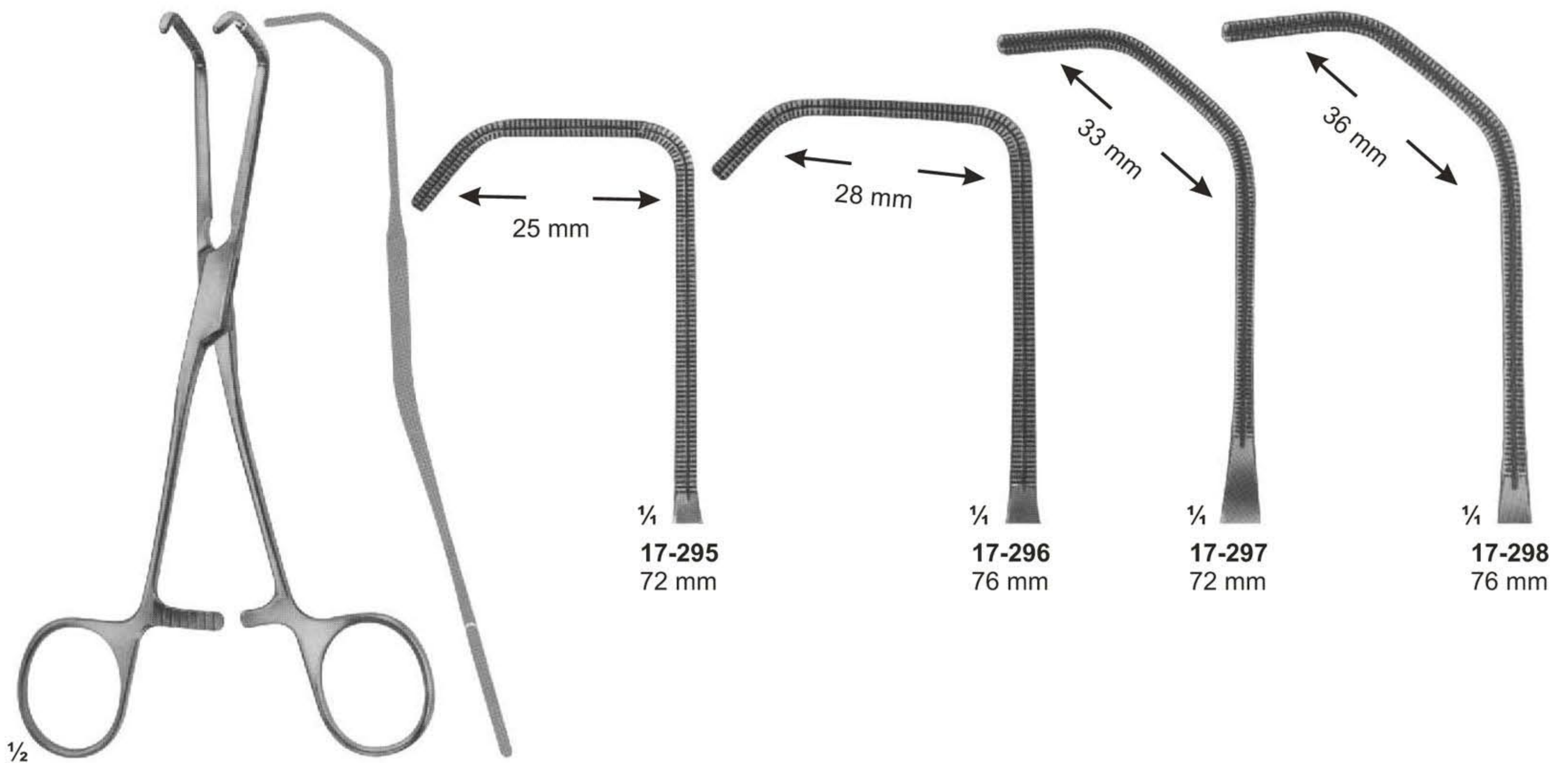

**17-295 - 298**  
COOLEY  
165 mm, 165 mm  
175 mm, 180 mm

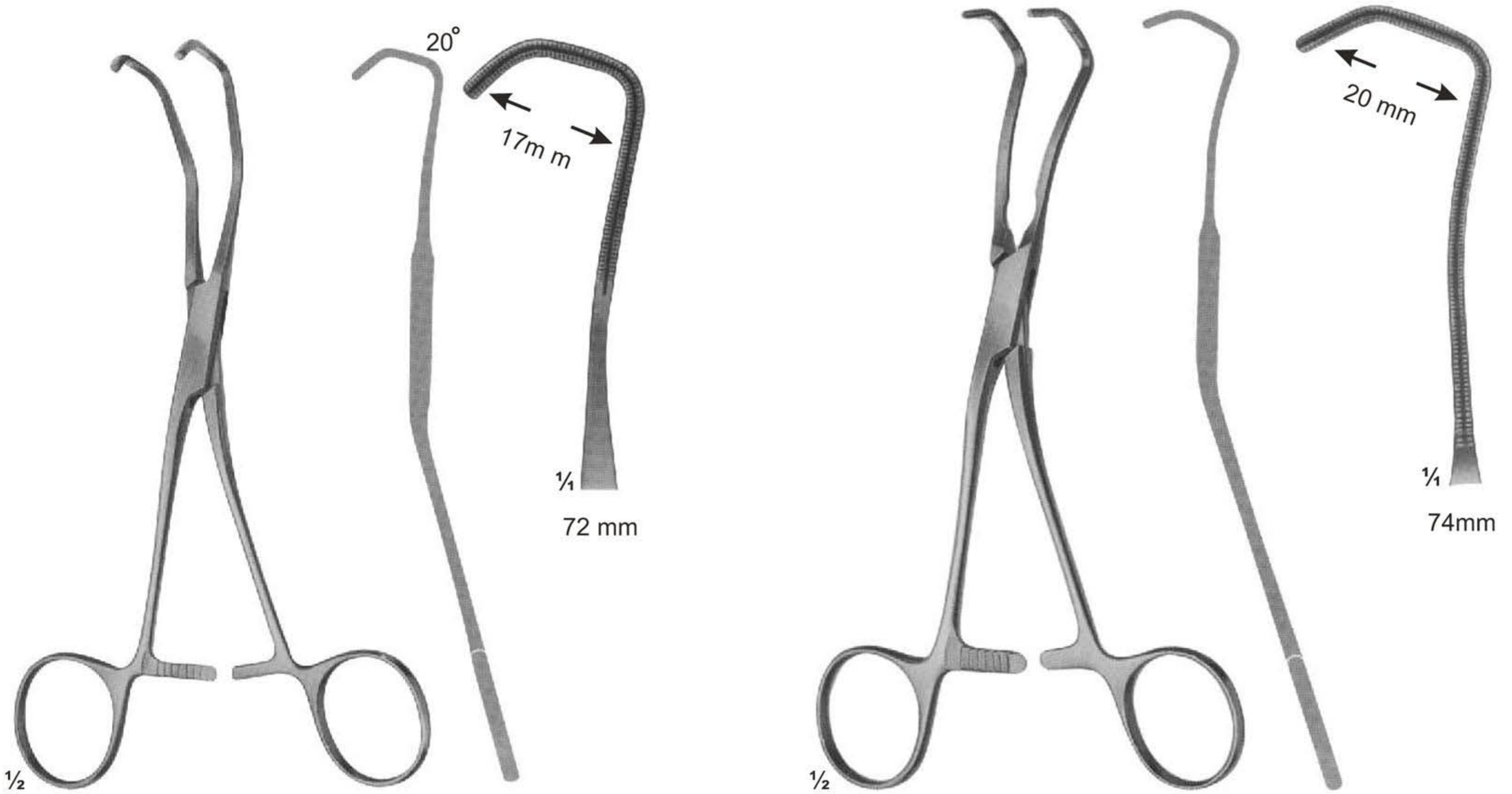

**17-299**  
COOLEY  
170 mm

**17-300**  
COOLEY  
175 mm



# Aorta-Anastomosis Clamps

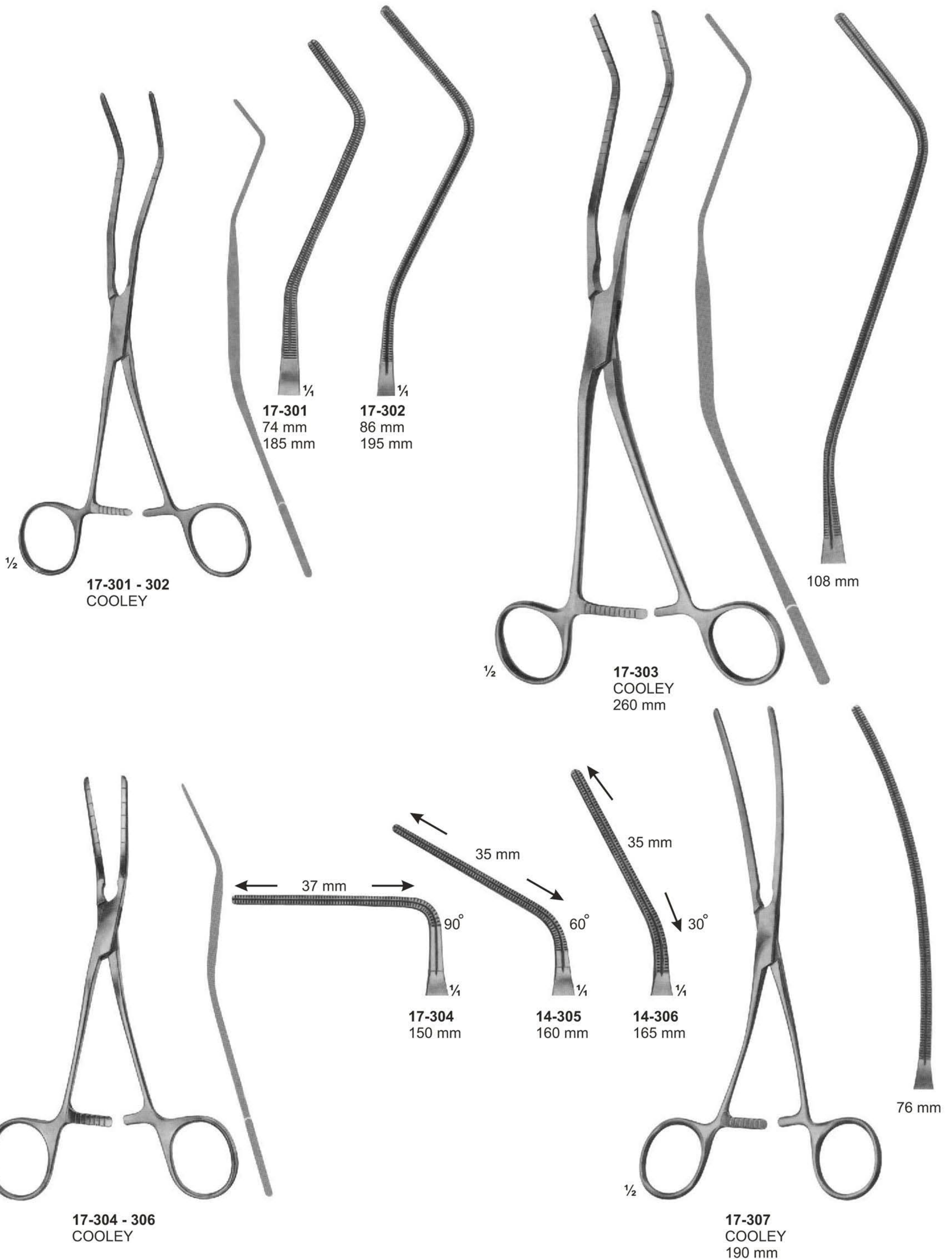



# Aorta-Anastomosis Clamps

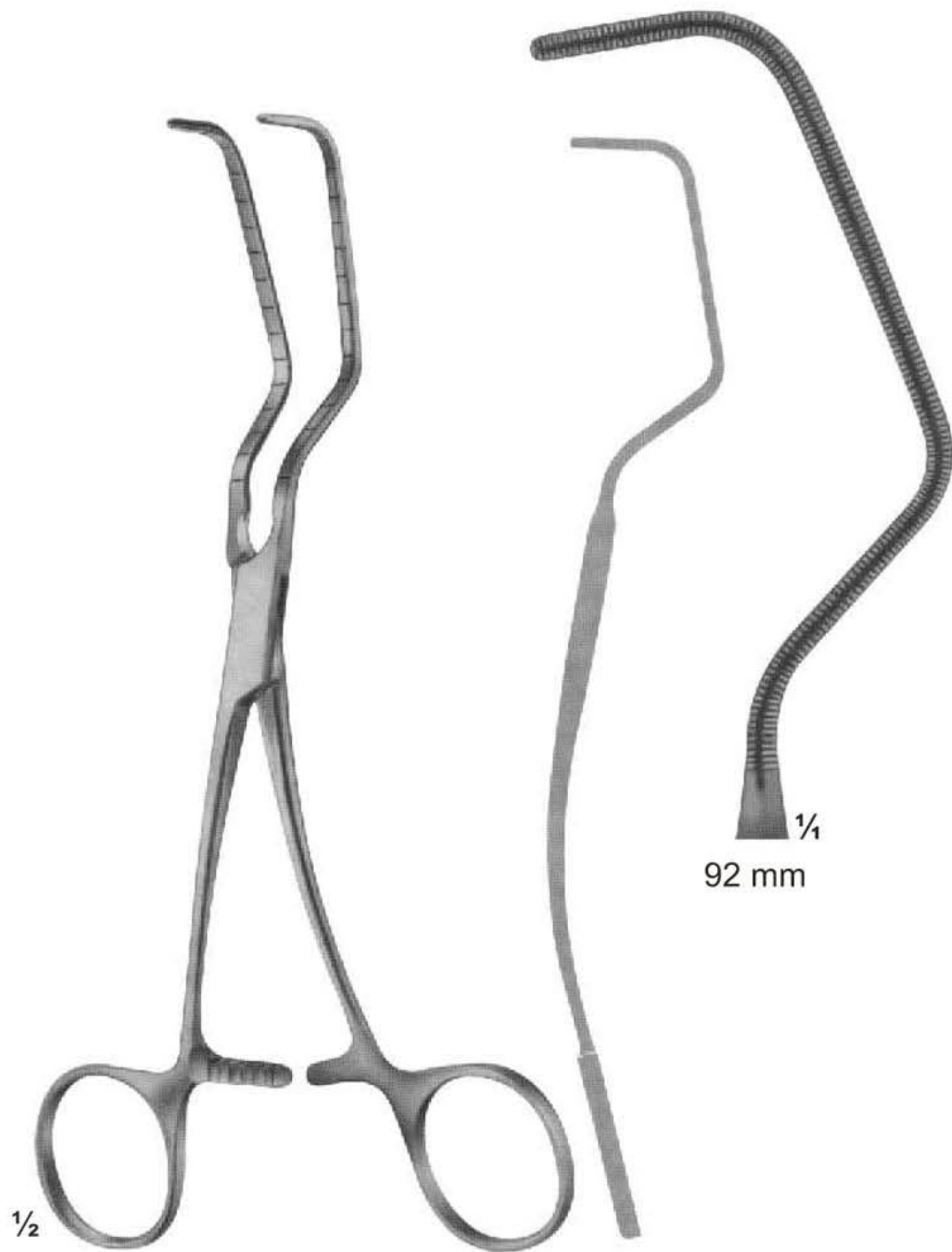

**17-308**  
PARRY-COOLEY  
185 mm

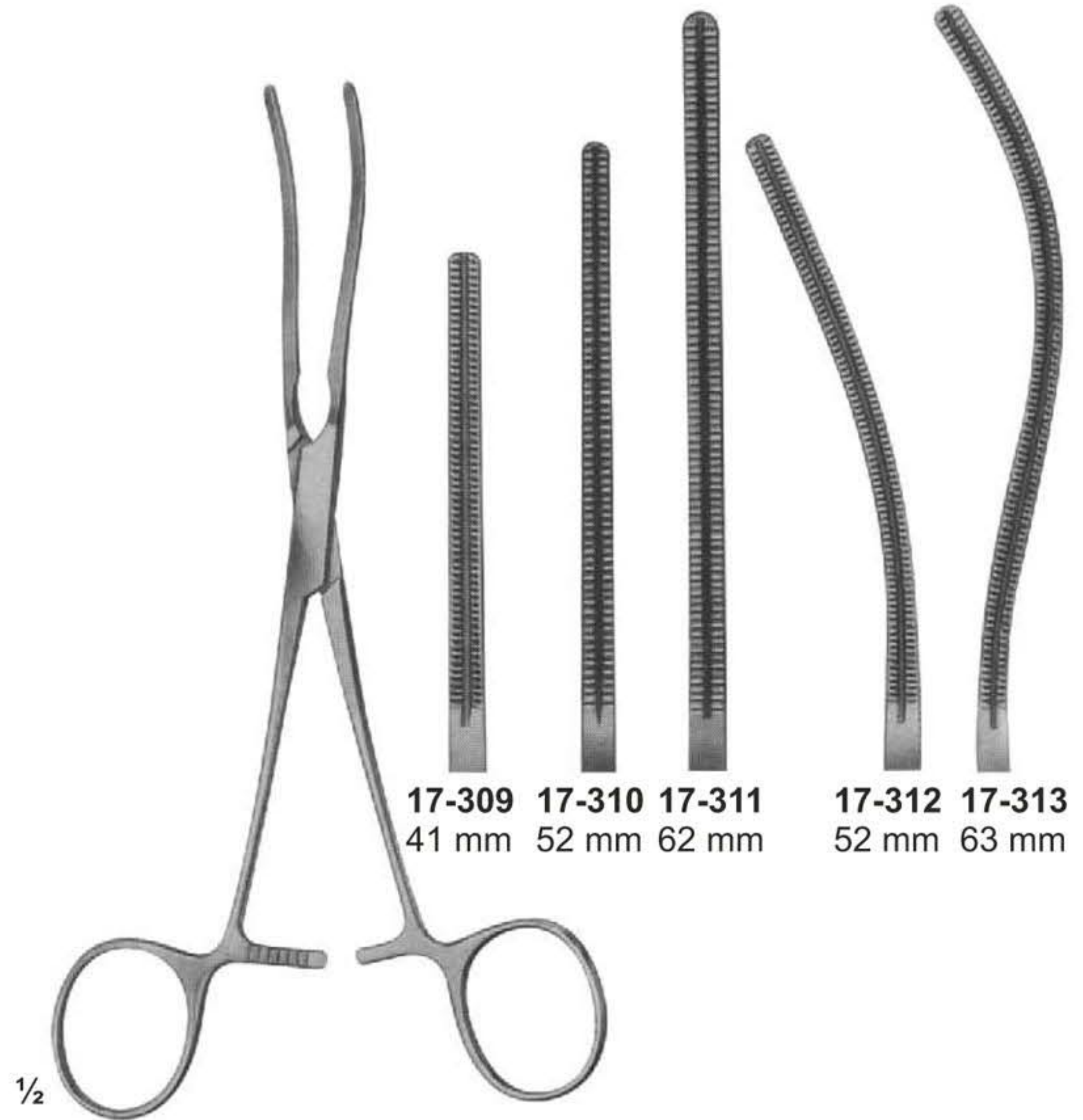

**17-309 - 313**  
COOLEY  
160 mm, 170 mm, 180 mm

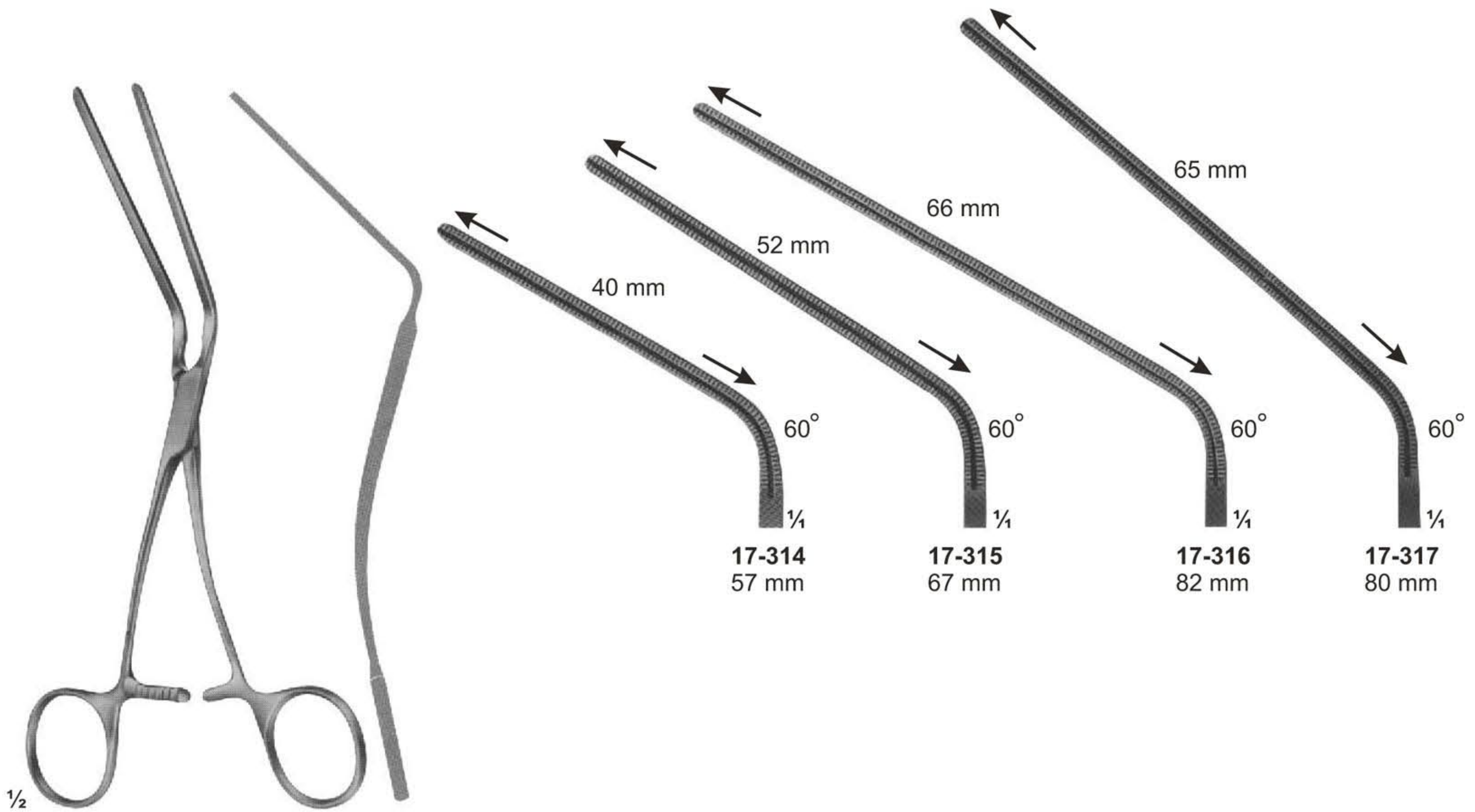

**17-314 - 317**  
165 mm, 170 mm,  
185 mm, 185 mm



# Multi-Purpose Clamps



DARDIK			
17-318	150 mm	17-323	170 mm
17-319	150 mm	17-324	170 mm
17-320	150 mm	17-325	170 mm
17-321	145 mm	17-326	160 mm
17-322	130 mm	17-327	135 mm

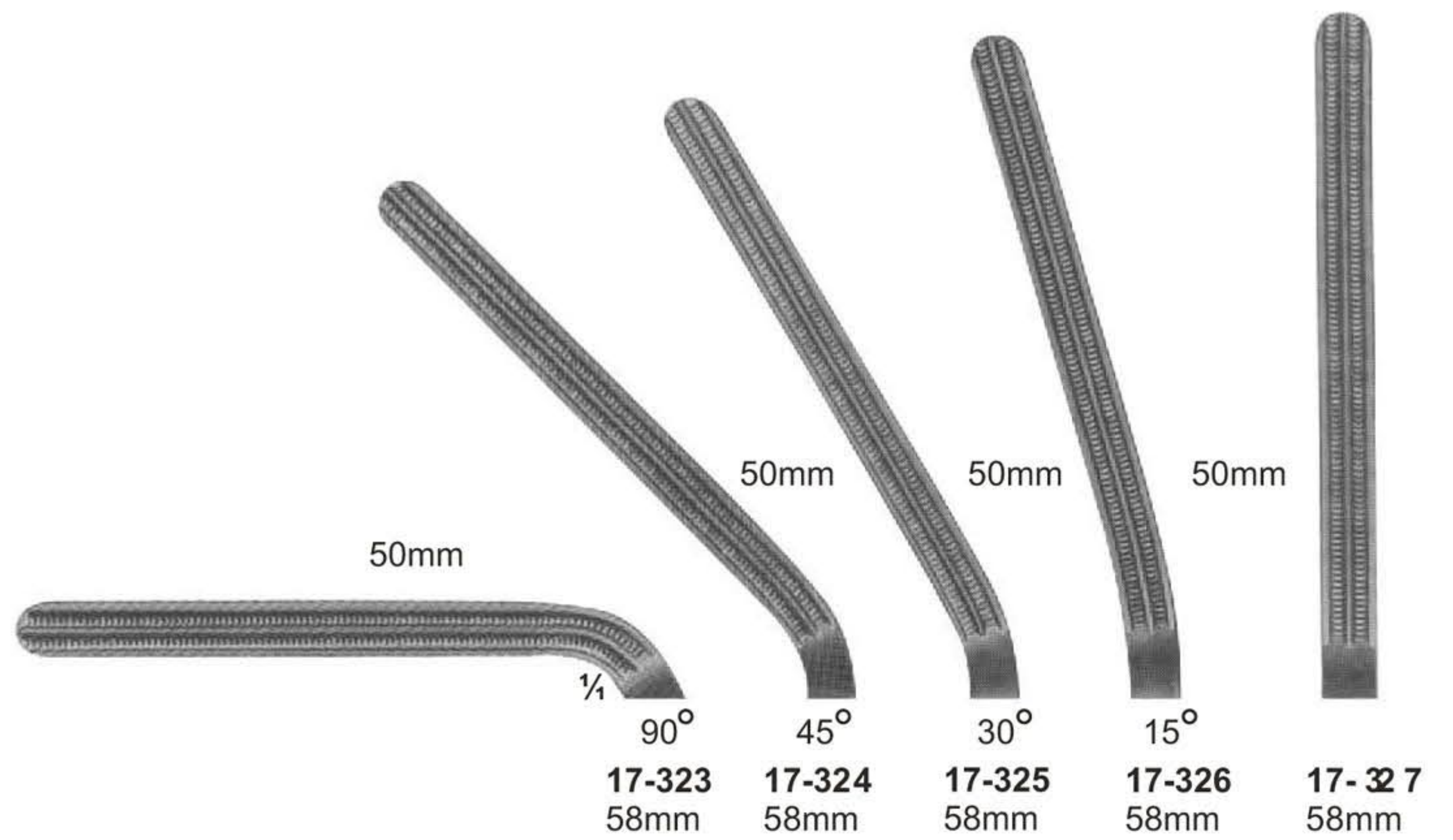
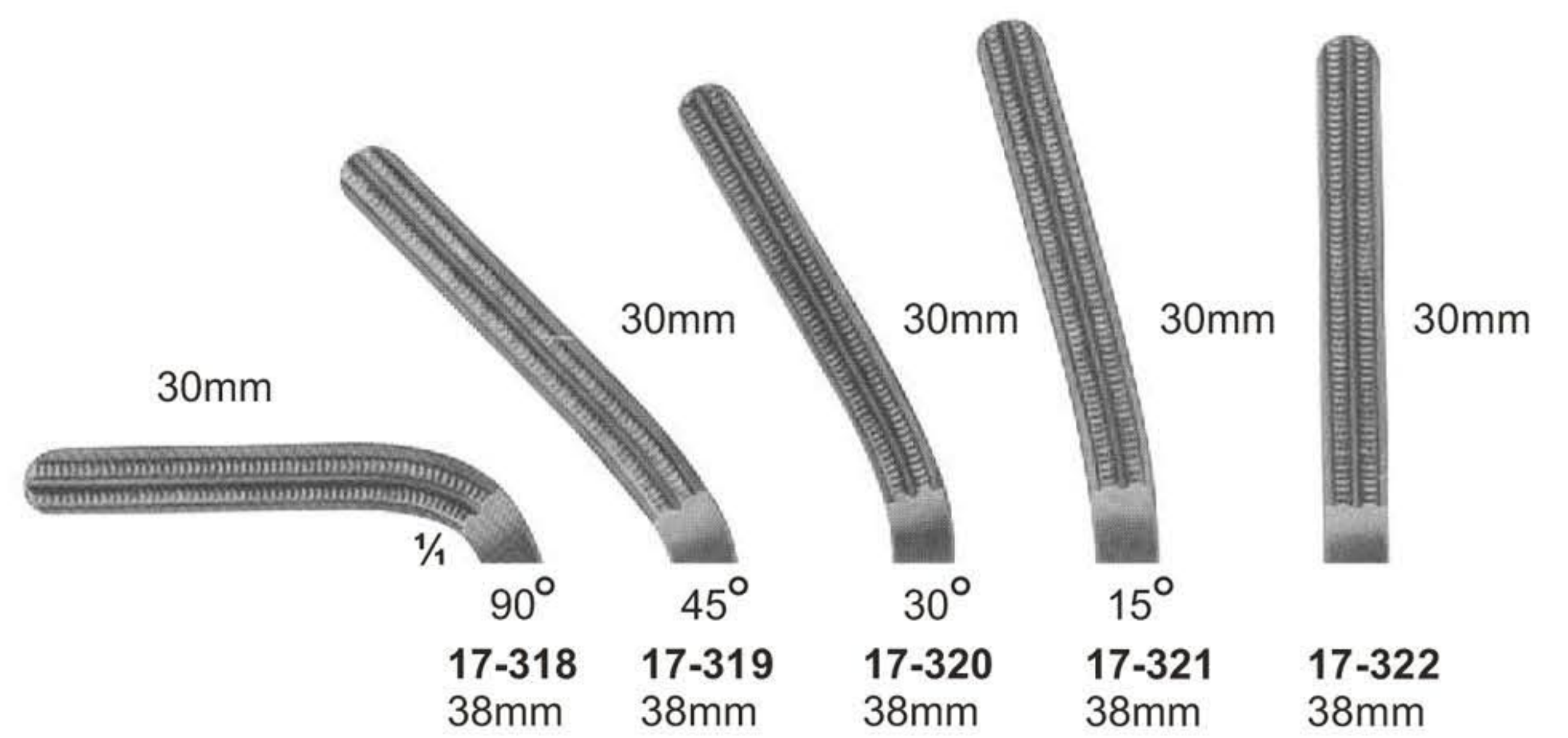



**Multi-Purpose Clamps**

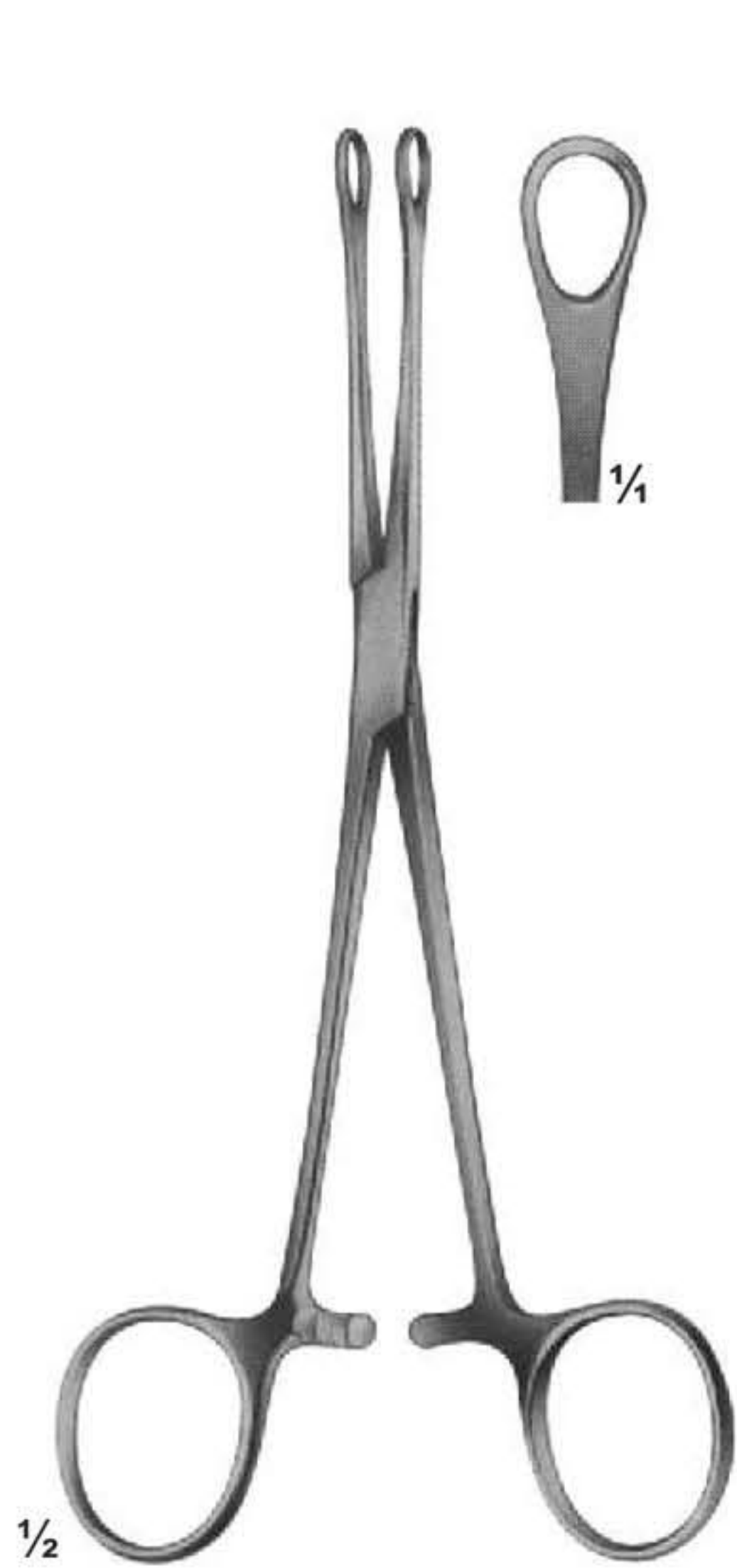

**17-328**  
WILLIAMS  
160 mm



**17-329**  
TUTTLE  
230 mm



**17-330**  
NELSON  
230 mm

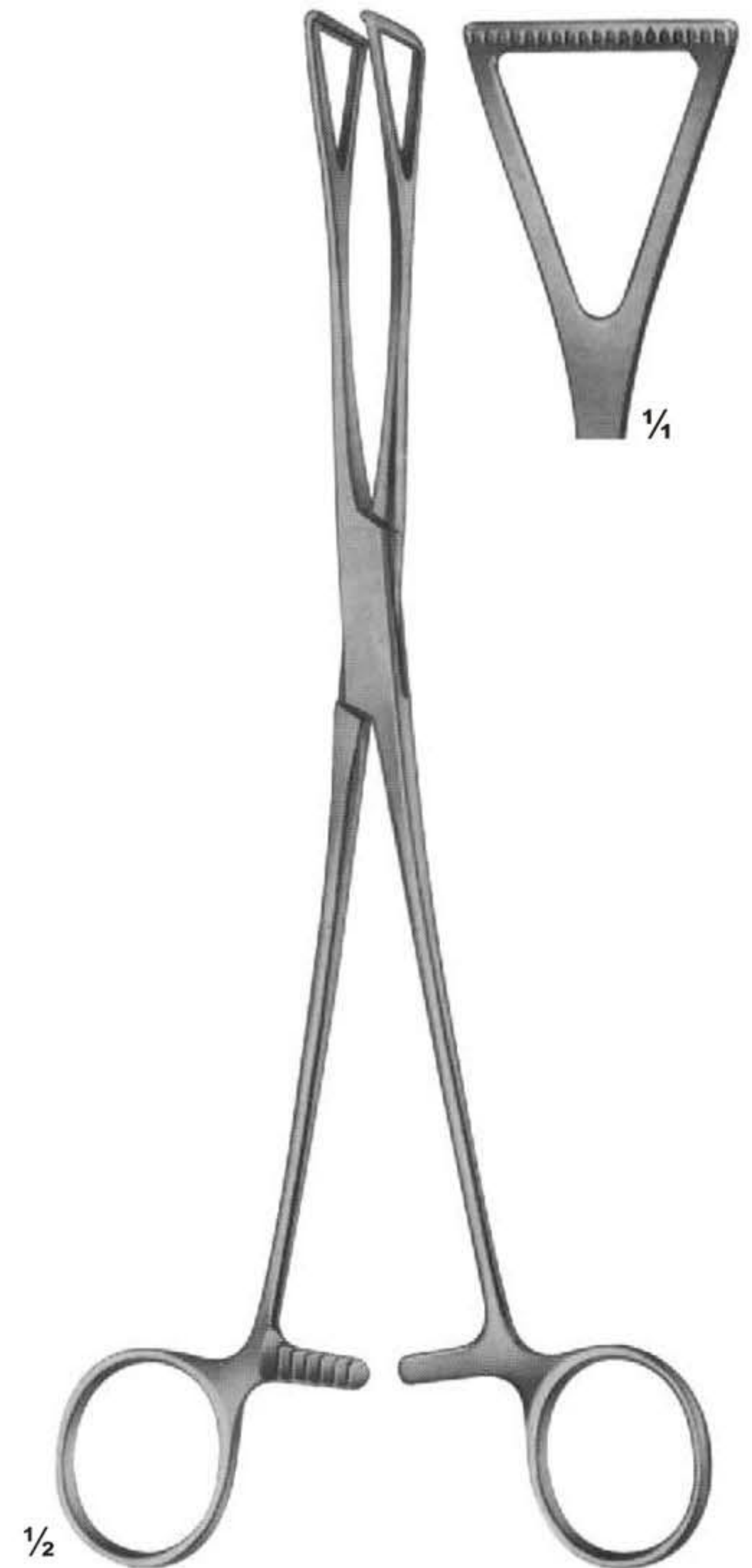

**17-331**  
DUVAL  
230 mm

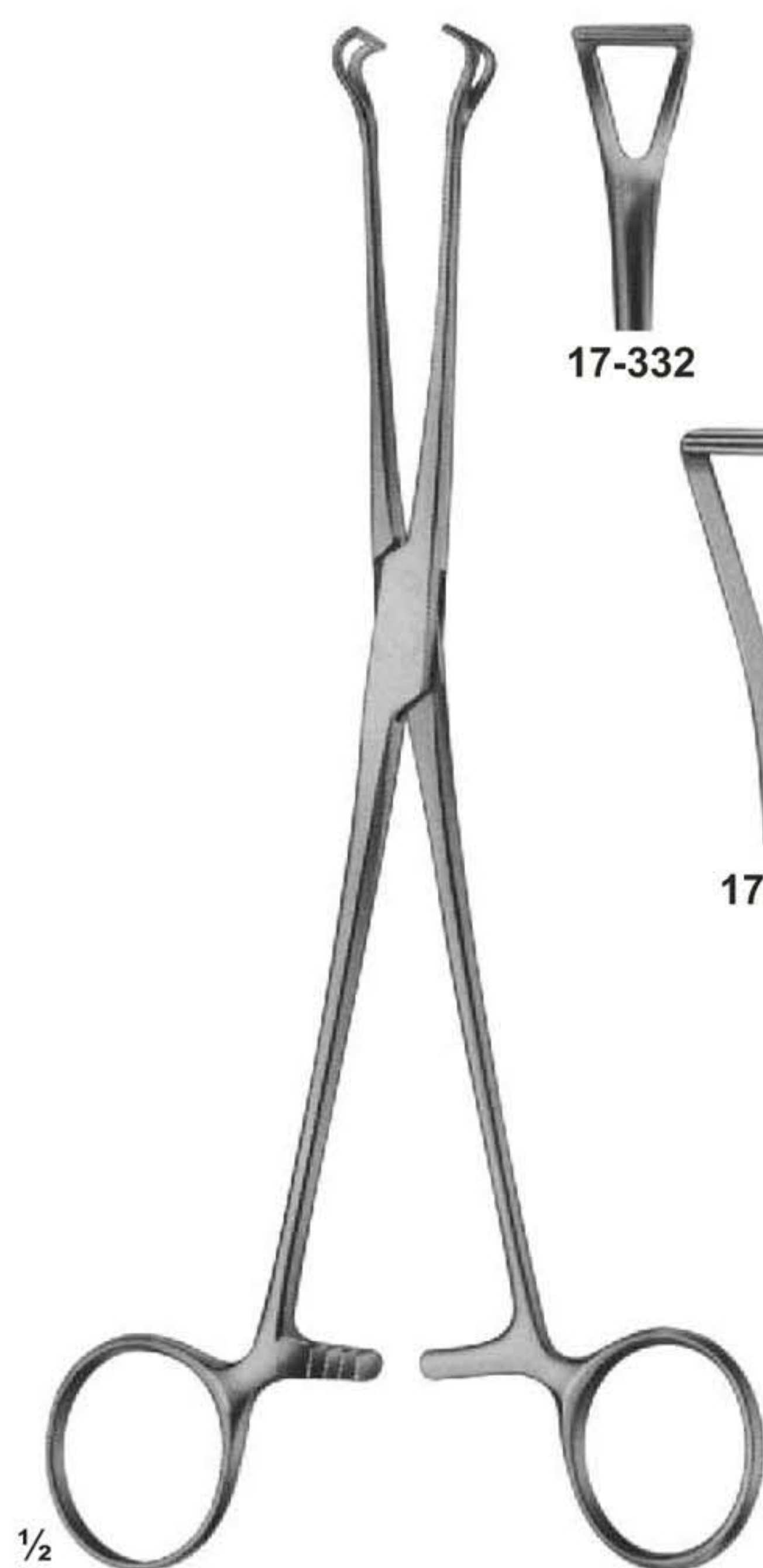

**BABCOCK**  
**17-332** 170 mm  
**17-333** 215 mm  
**17-334** 220 mm

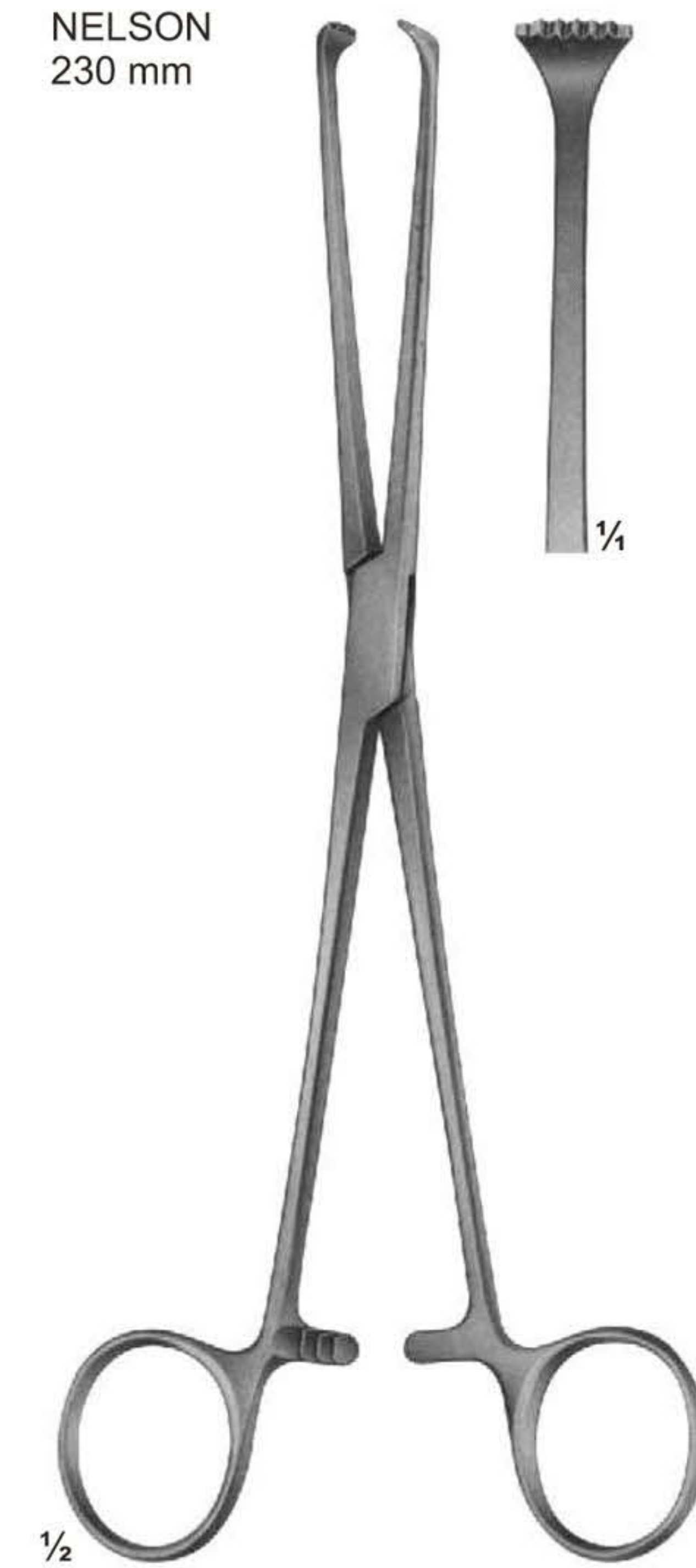
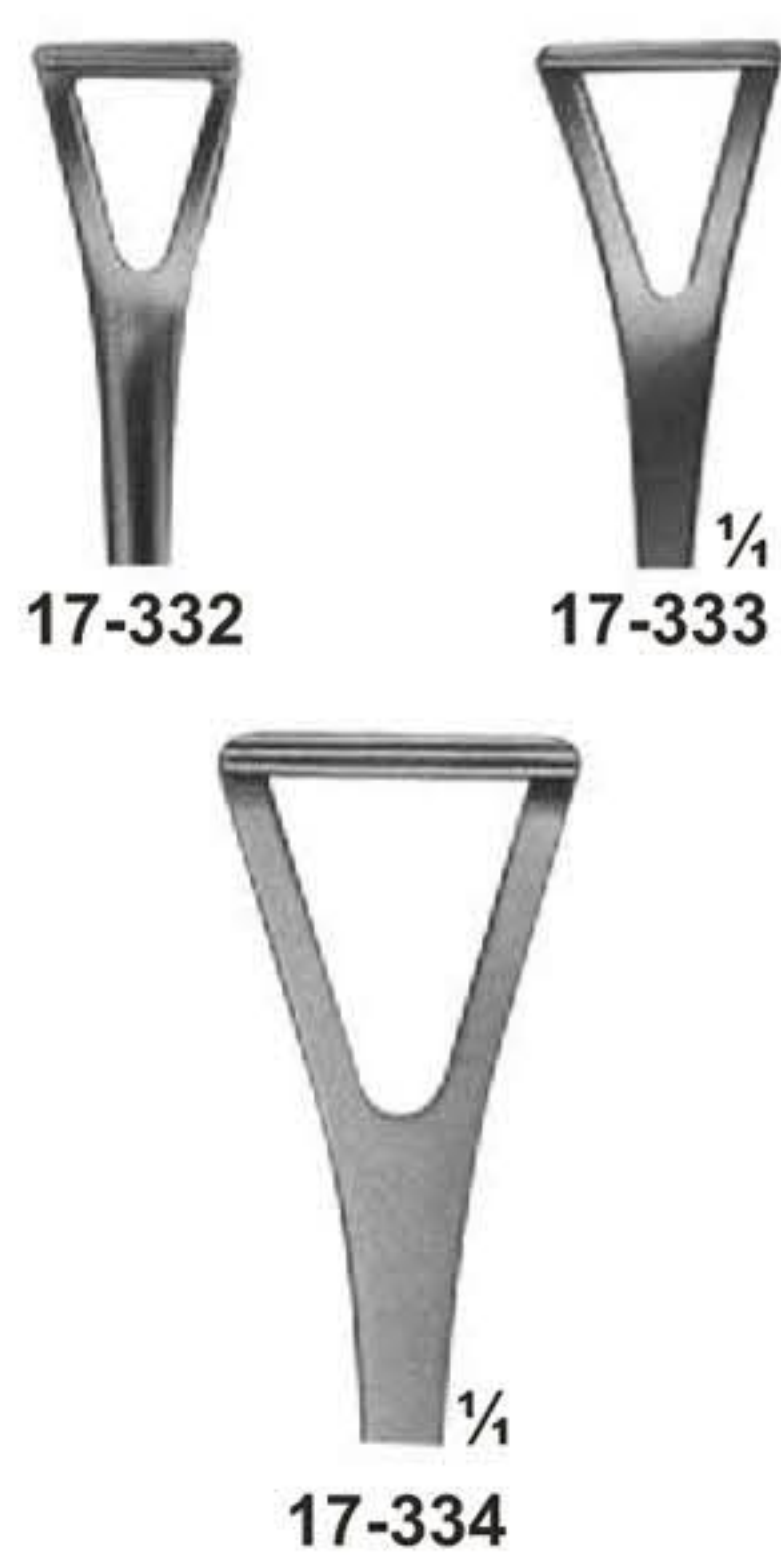

**17-335**  
ALLIS  
220 mm



## Multi-Purpose Clamps

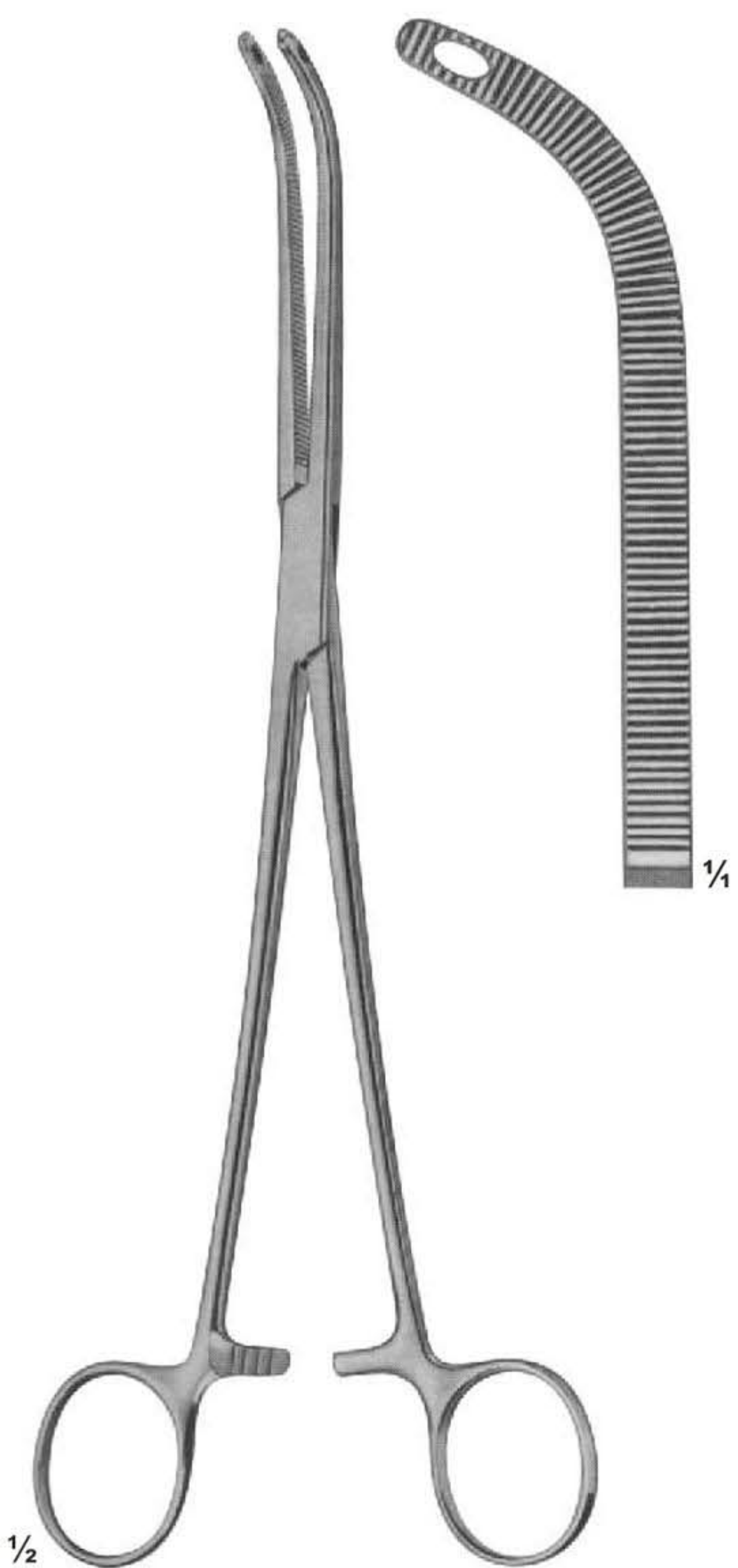

**17-336**  
FINOCHIETTO  
245 mm



**17-337 - 338**  
SEMB  
244 mm

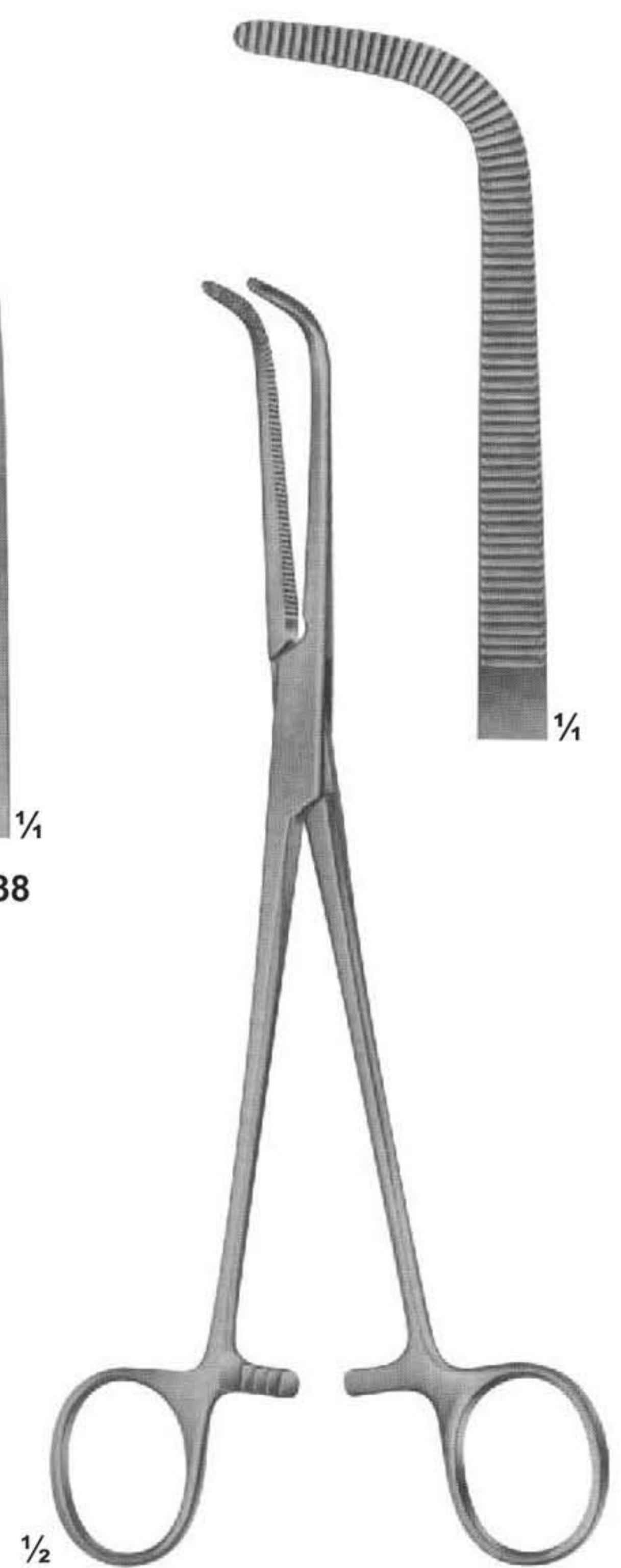

**17-339**  
WIKSTROEM  
205 mm



**Multi-Purpose Clamps**



**17-340**  
MIXTER  
230 mm

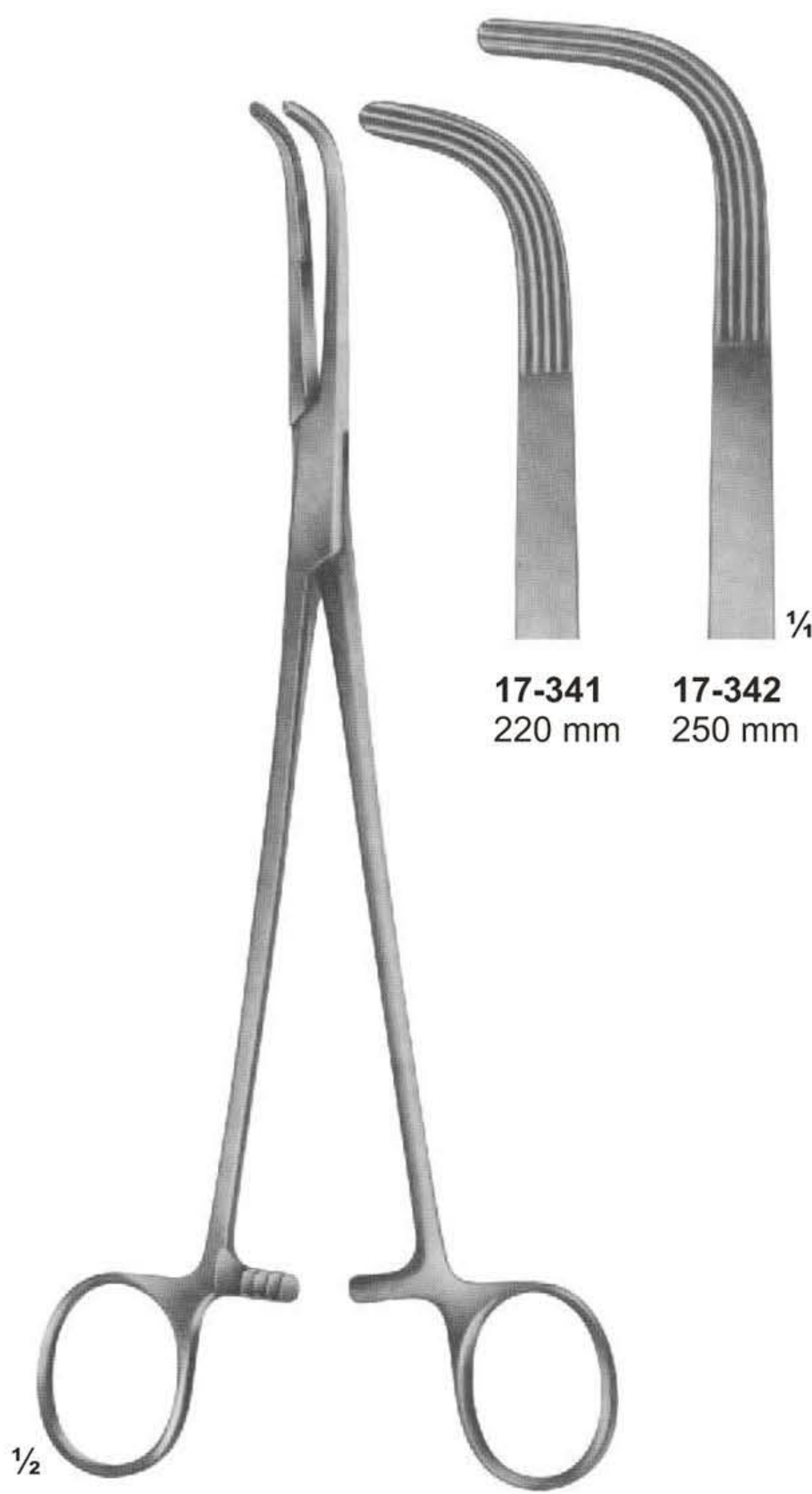

**17-341** 220 mm  
**17-342** 250 mm

**17-341 - 342**  
MIXTER

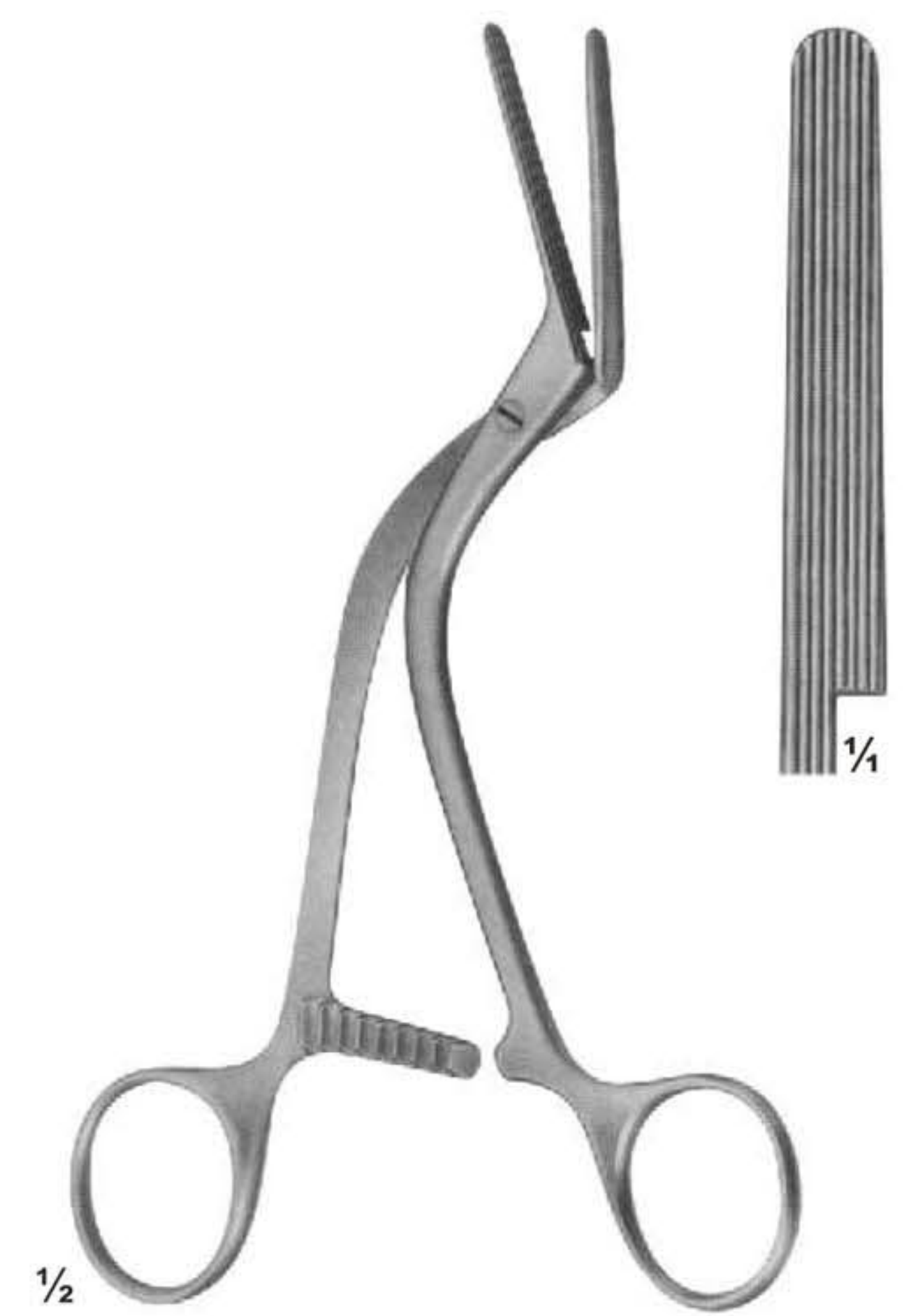

**17-343**  
HOPFNER  
160 mm



## Multi-Purpose Clamps

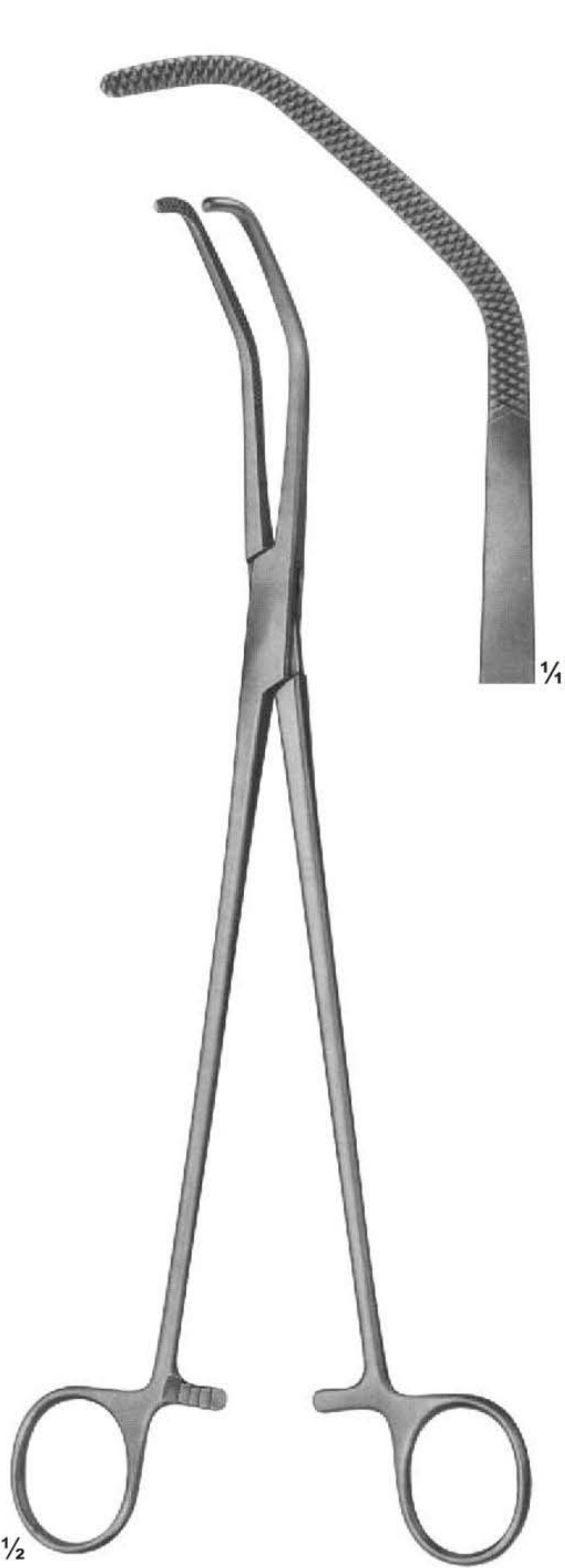

**17-344**  
SATINSKY  
265 mm



**17-345**  
SATINSKY  
265 mm

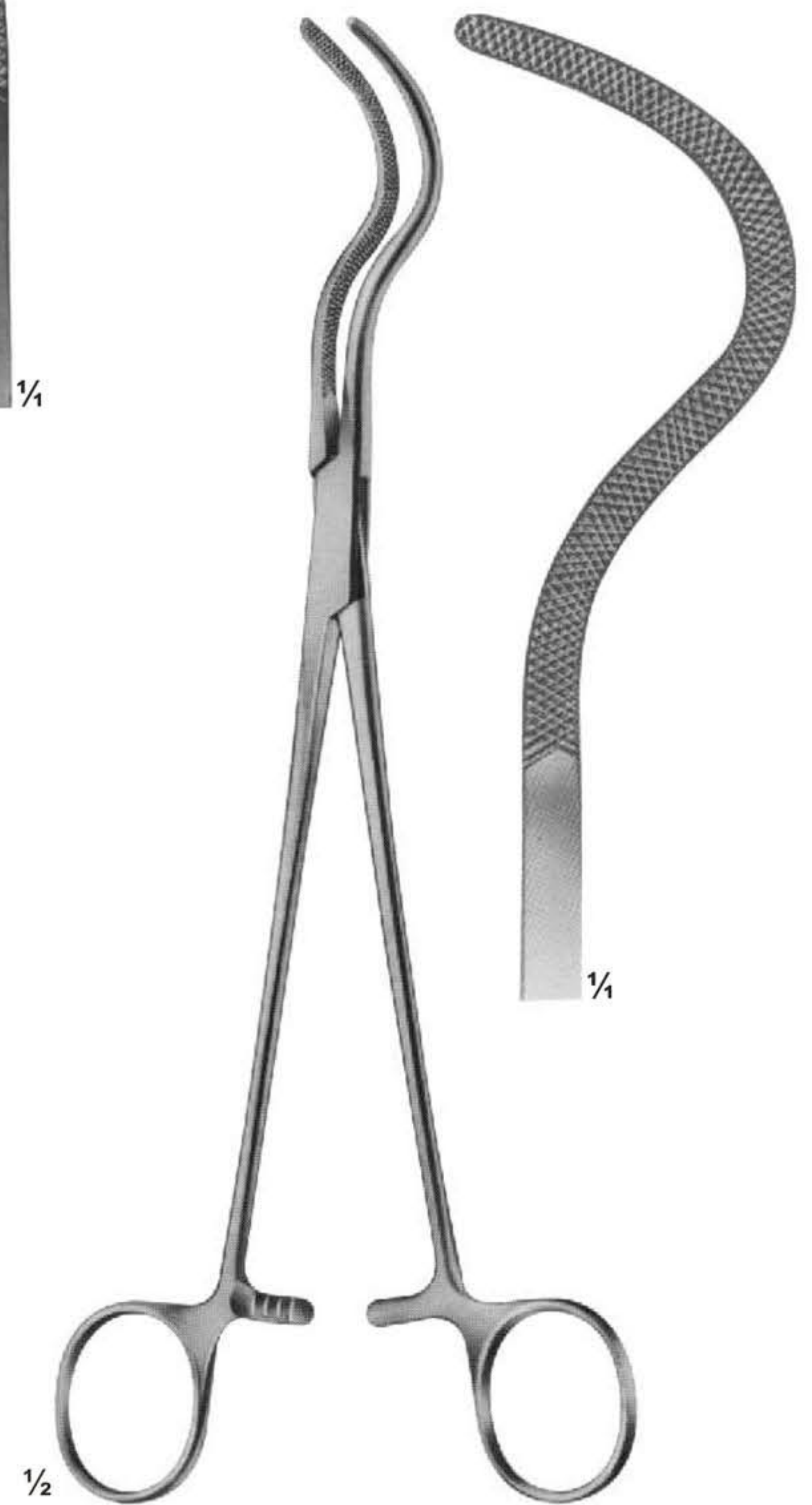

**17-346**  
HARKEN  
240 mm



## Multi-Purpose Clamps



**17-347**  
PERTUISET  
Carotid Clamp  
90 mm

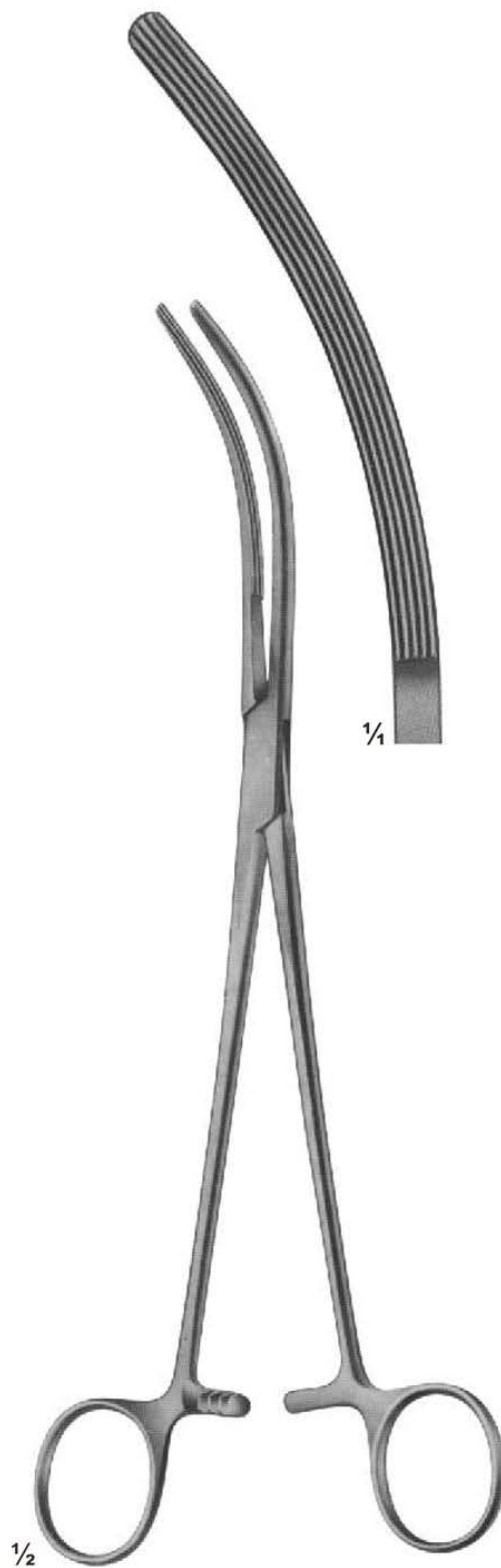

**17-348**  
CRAFOORD-SELLORS  
240 mm

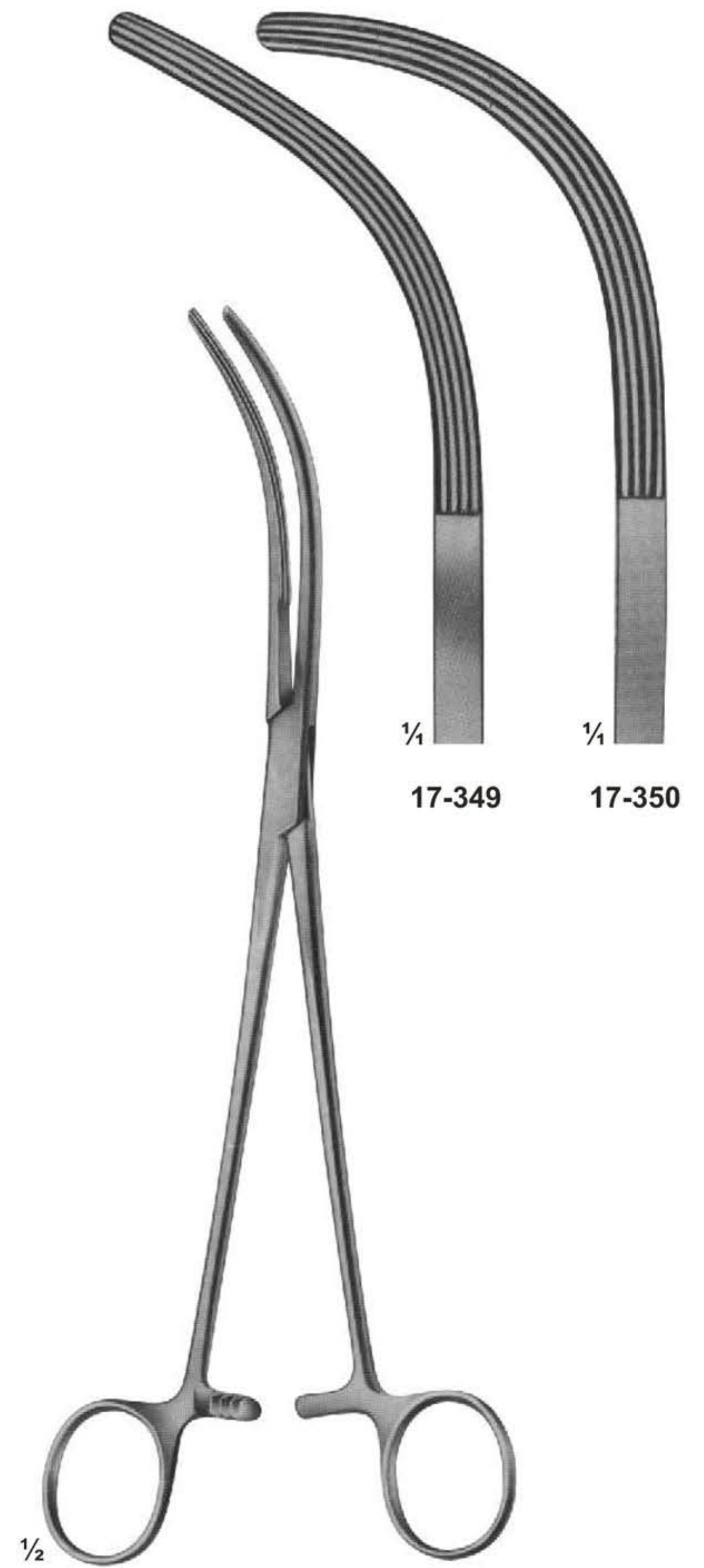

**17-349 - 350**  
CRAFOORD  
240 mm





# Multi-Purpose Clamps



**17-351**  
PRICE THOMAS  
225 mm



**17-352**  
jaws with pins

**17-353**  
jaws with pins

**17-352 - 353**  
PRICE THOMAS  
225 mm



**Rib Shears**



**17-354**  
SCHUMACHER  
Sternum shears  
210 mm



**17-355**  
LEBSCHKE  
Sternum chisel  
200 mm



**17-356**  
230 mm



**17-357**  
COLLIN  
195 mm

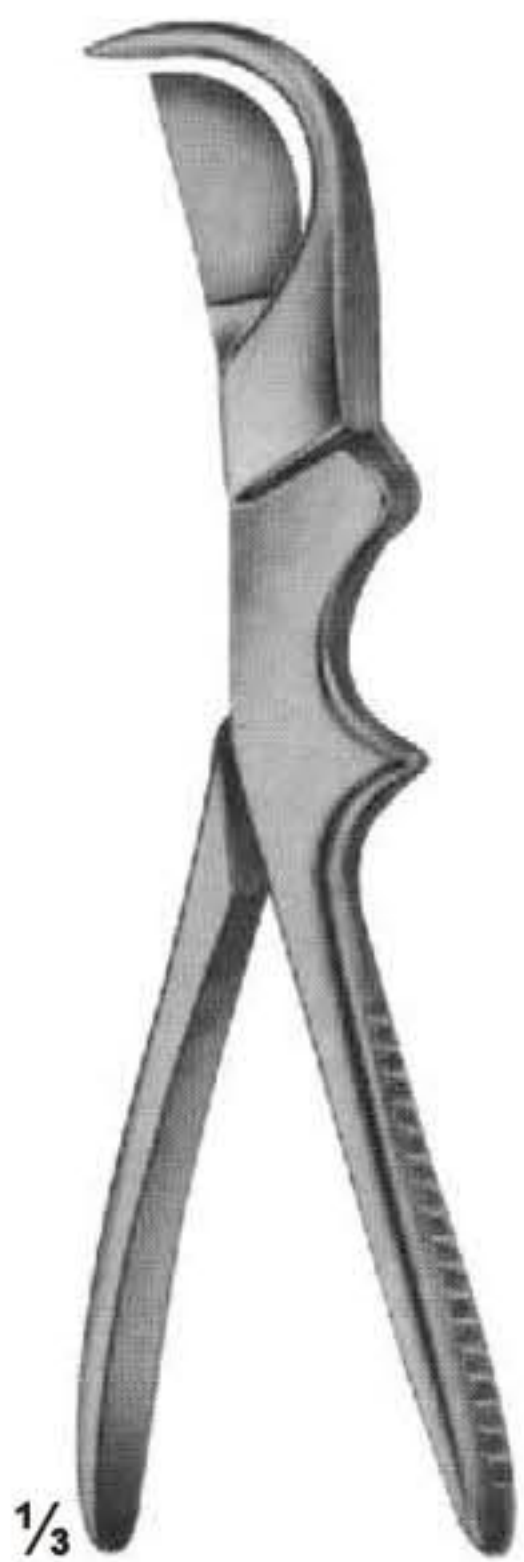

**17-358**  
GLUCK  
190 mm



**17-359**  
GLUCK  
190 mm



**17-360**  
BRUNNER  
Universal Pattern  
340 mm



**17-361**  
GIERTZ-STILLE  
250 mm



# Rib Holding Forceps, Bone Cutting Forceps

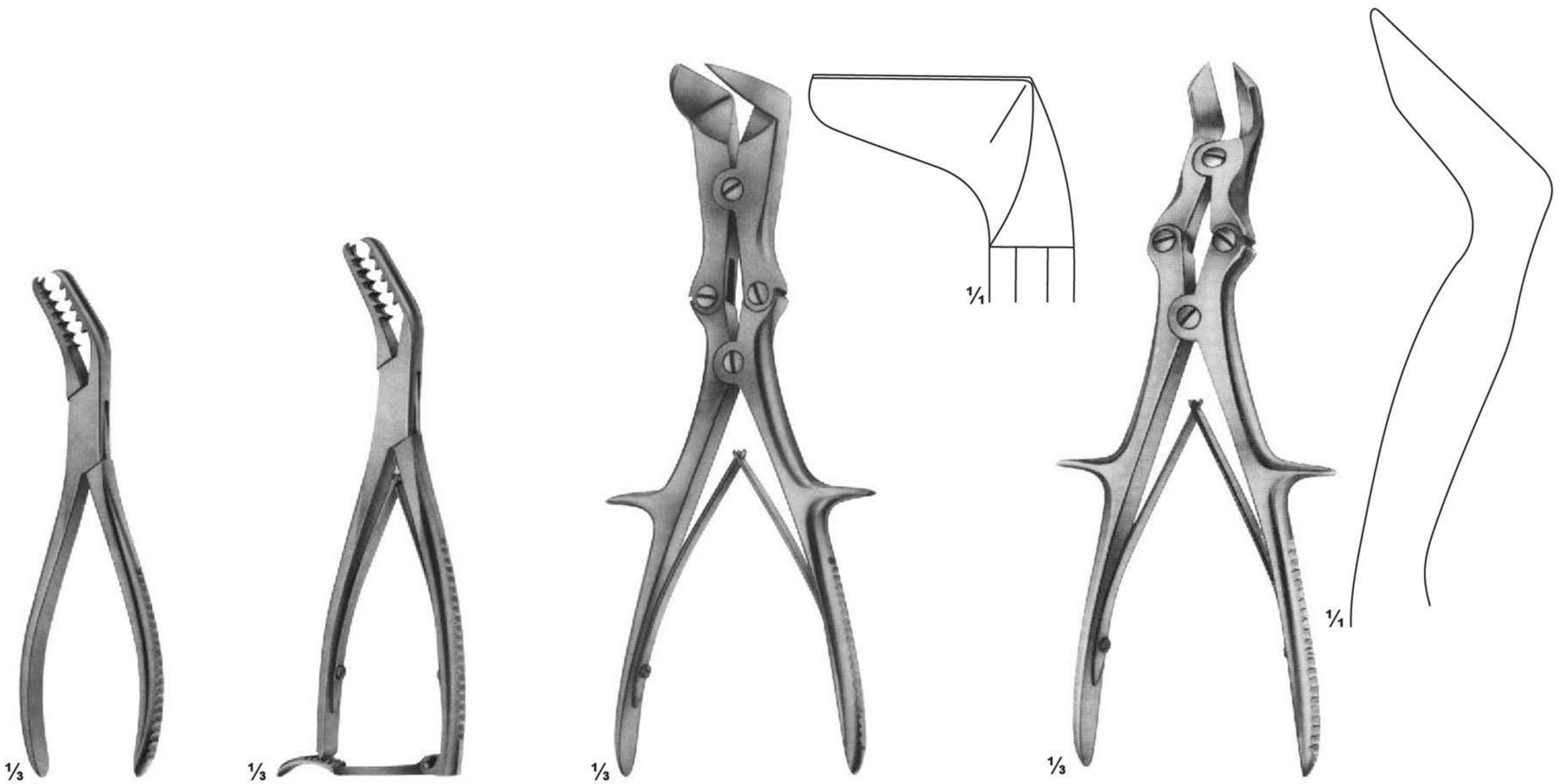

**17-362**  
SEMB  
Rib-and Bone  
Holding forceps  
190 mm

**17-363**  
SEMB  
Rib-and Bone  
Holding forceps  
190 mm

**17-364**  
LISTON-STILLE  
265 mm

**17-365**  
LISTON-KEY-HORSLEY  
255 mm

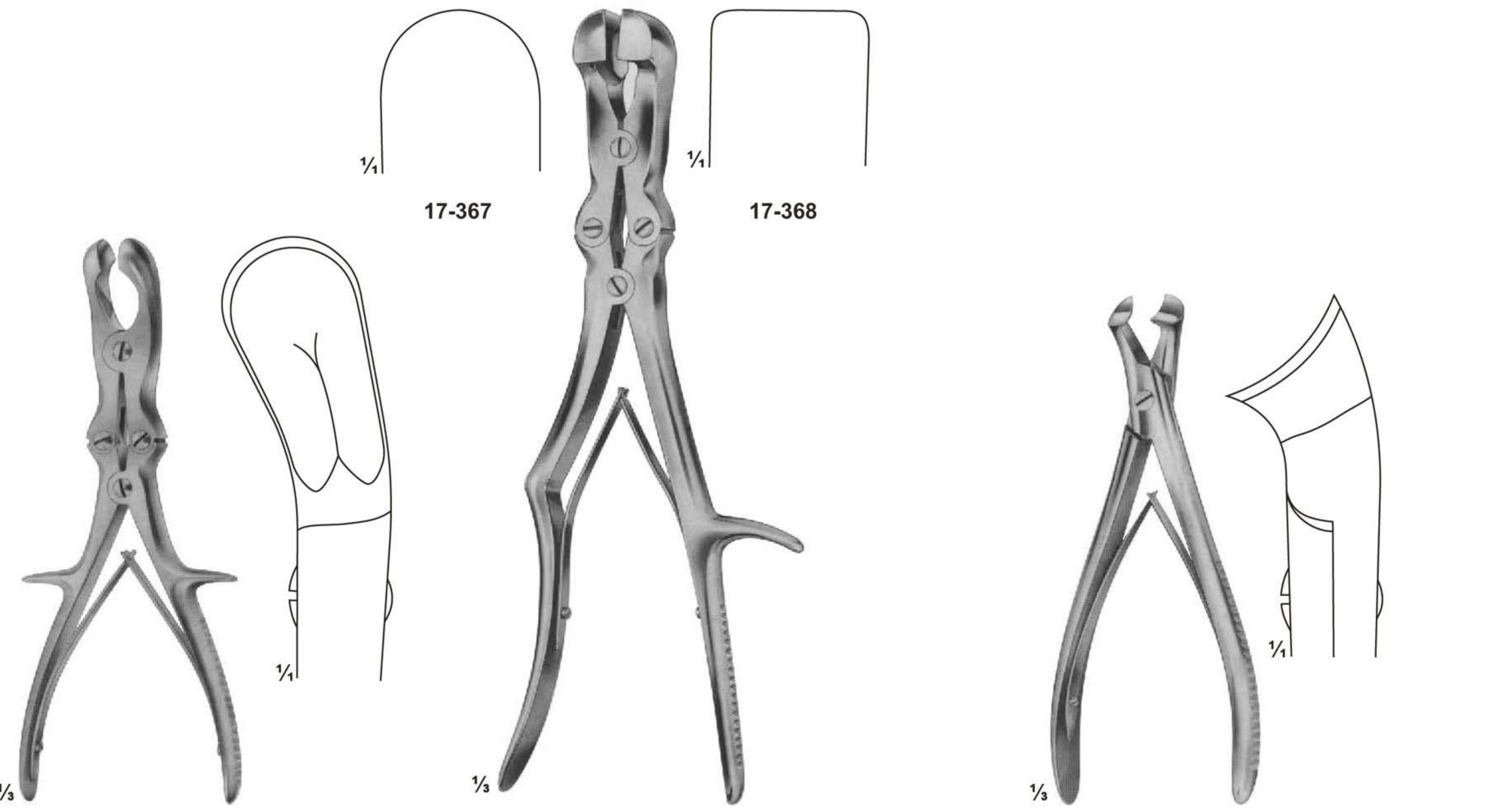

**17-366**  
SEME  
Rib Rongeur to shorten  
the rib stumps  
240 mm

**17-367-368**  
SAUERDRUCH-CORYLLOS  
Rib rongeurs to shorten  
the rib stumps  
310 mm

**17-369**  
MARKWALDER  
Rib Rongeur to Round  
the rib stumps  
190 mm



# Rib Raspatories

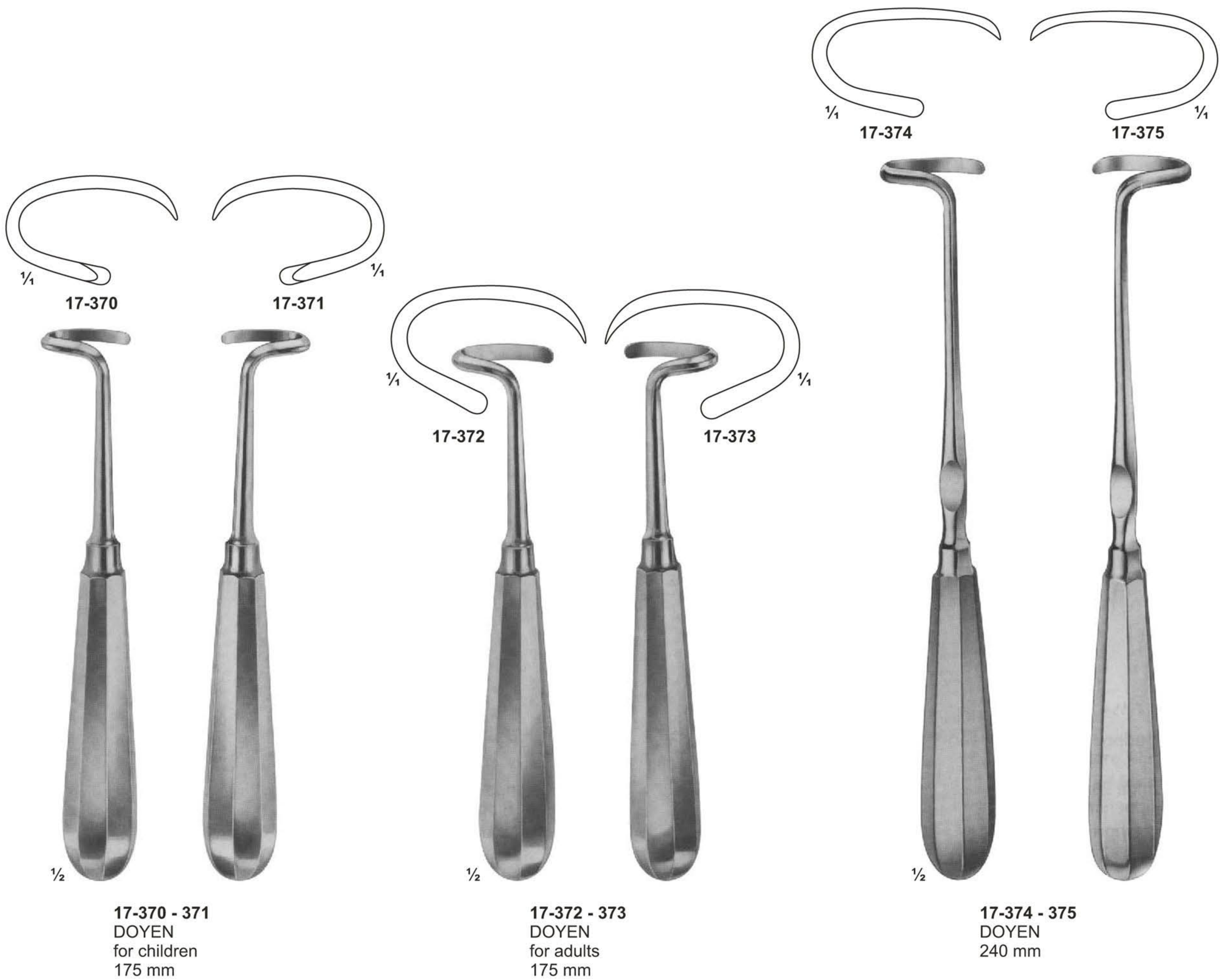



# Rib Raspatories

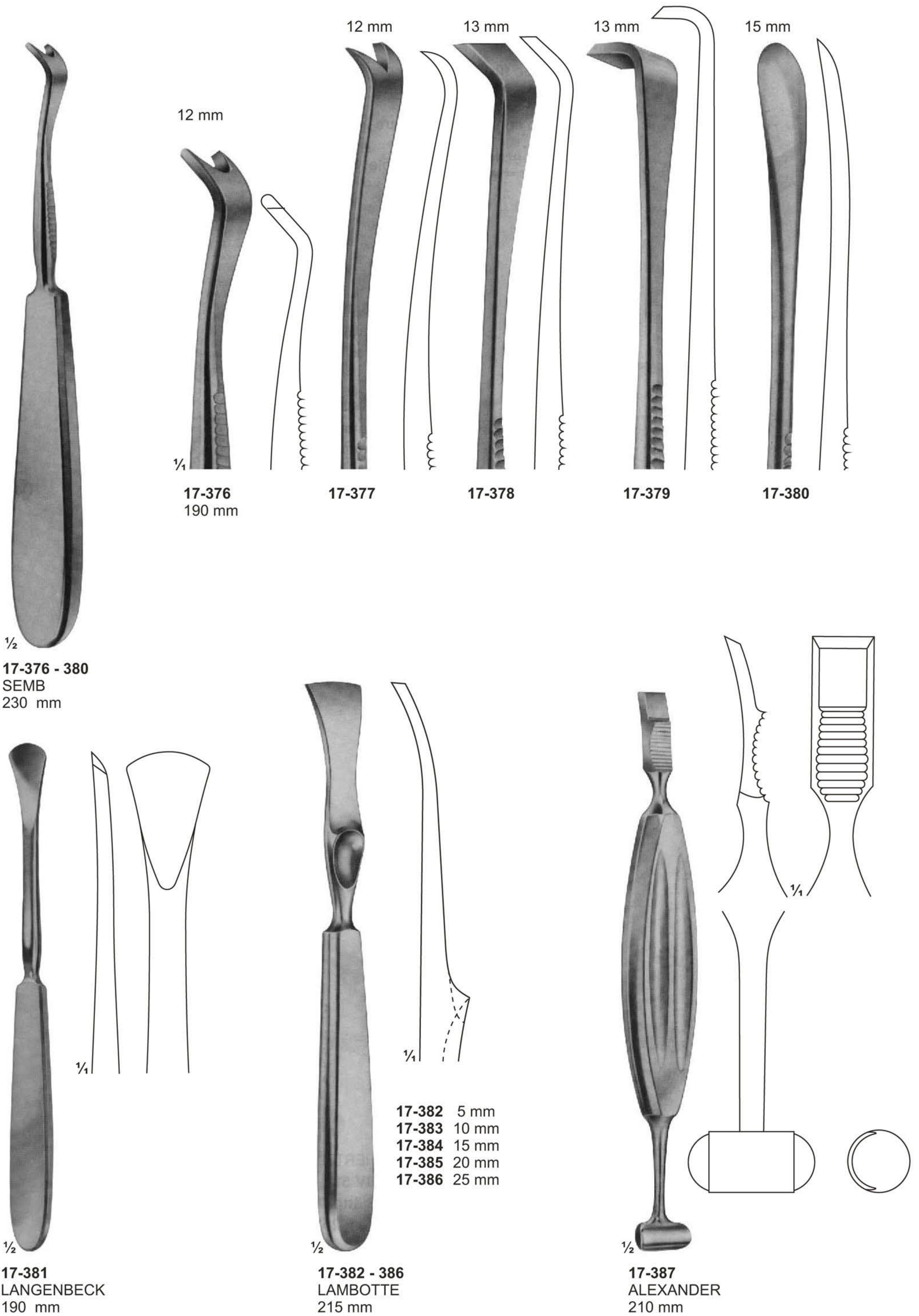



# Rib Spreaders

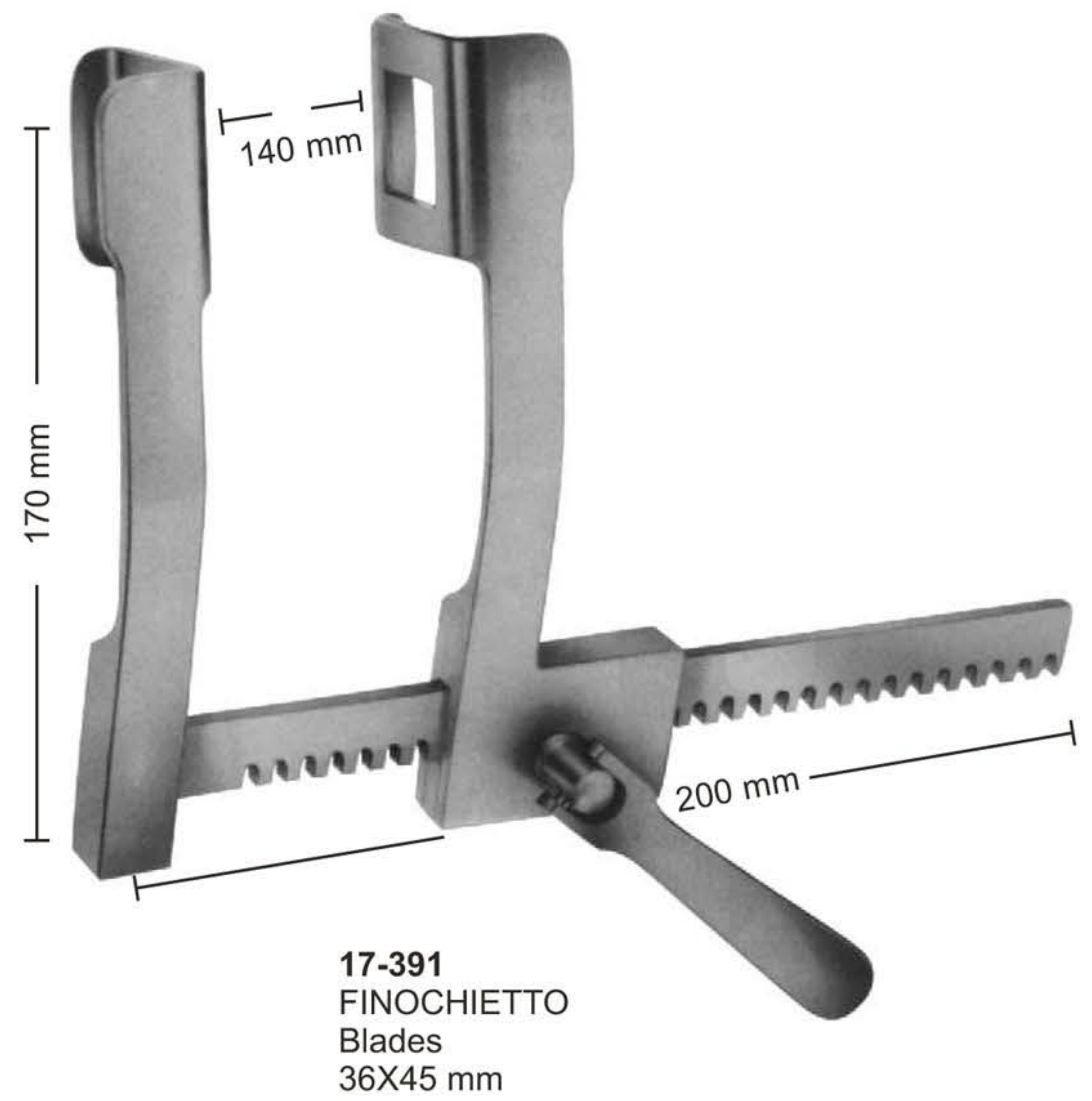
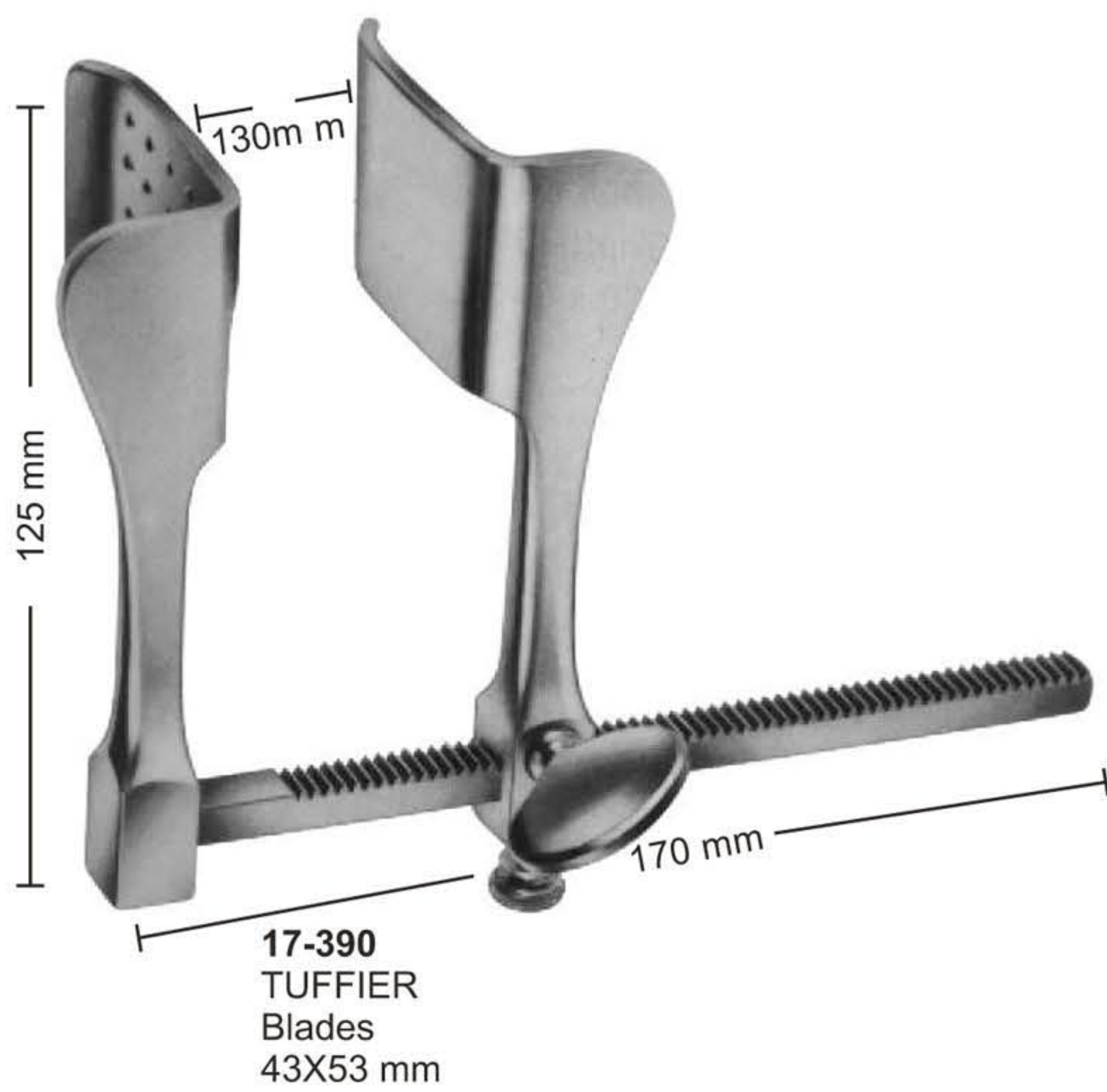
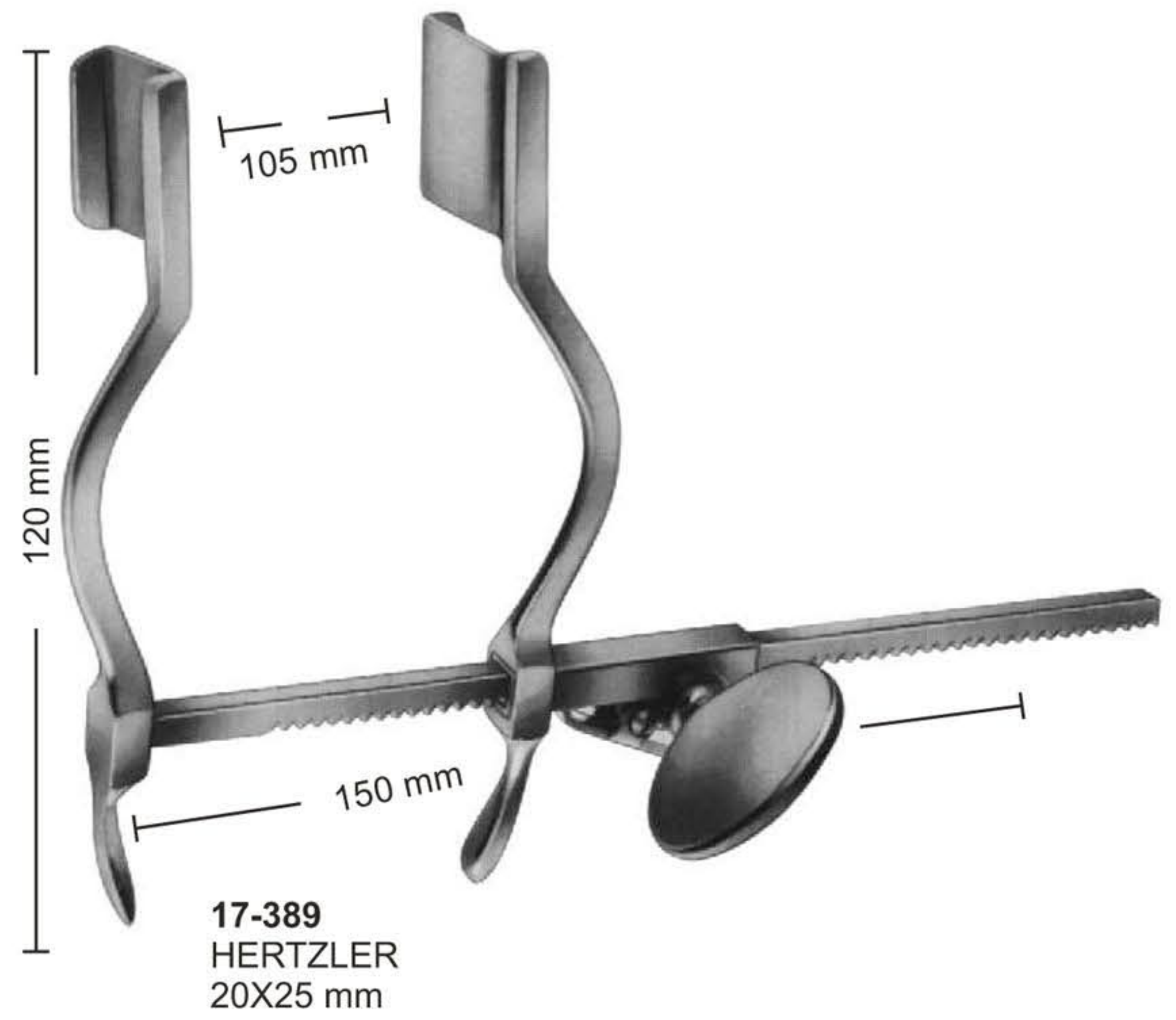
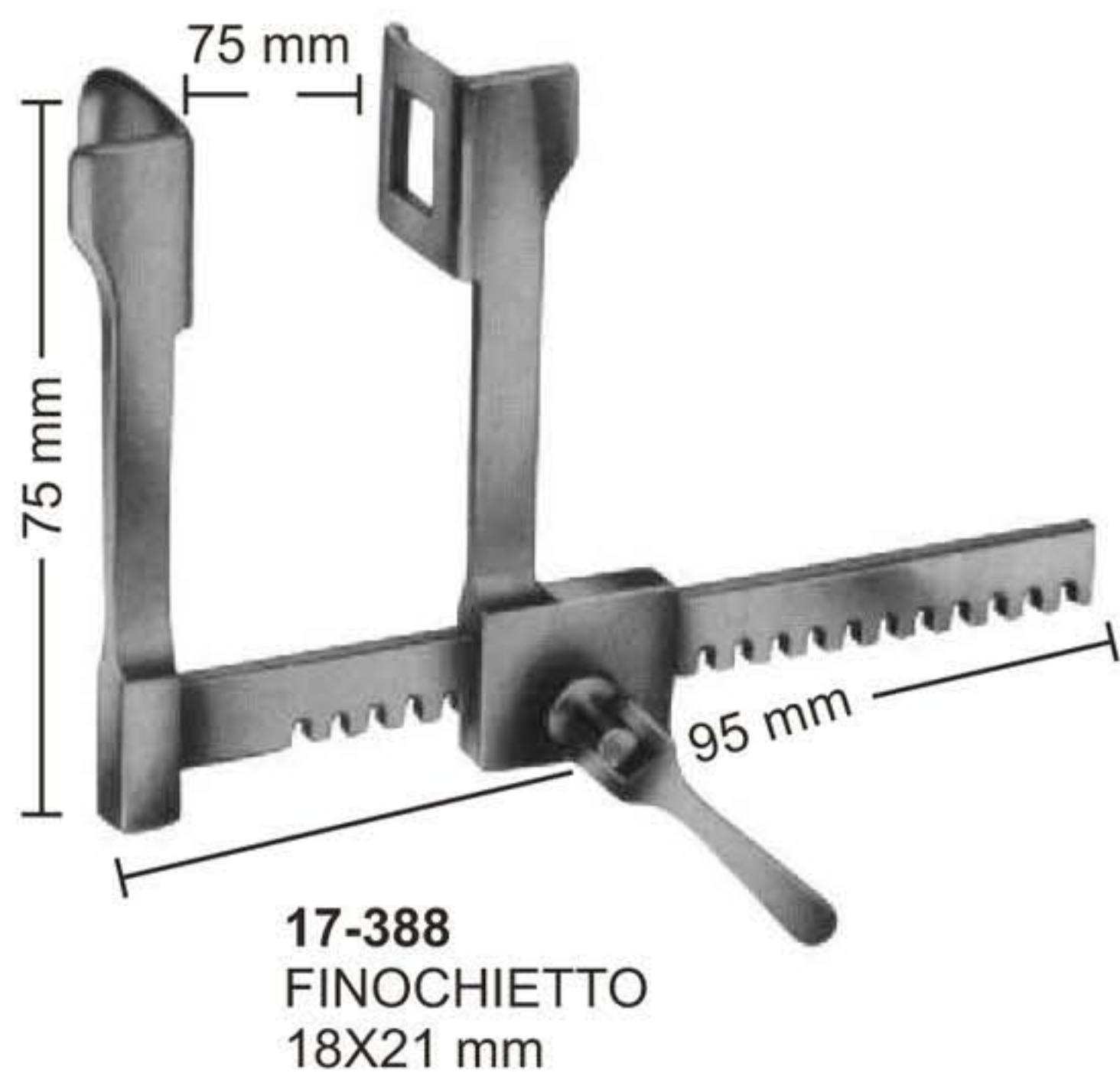



## Rib Spreaders

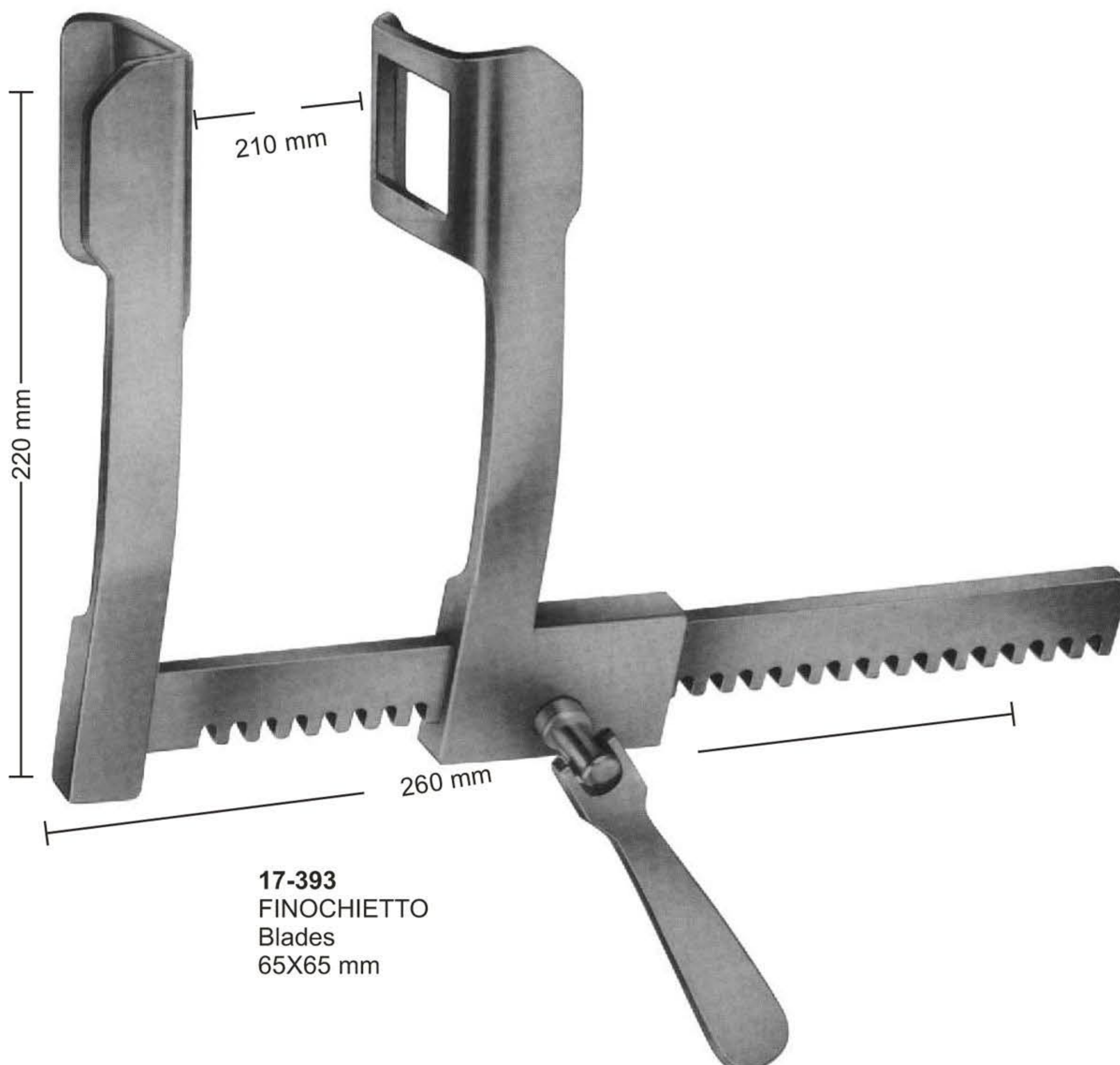
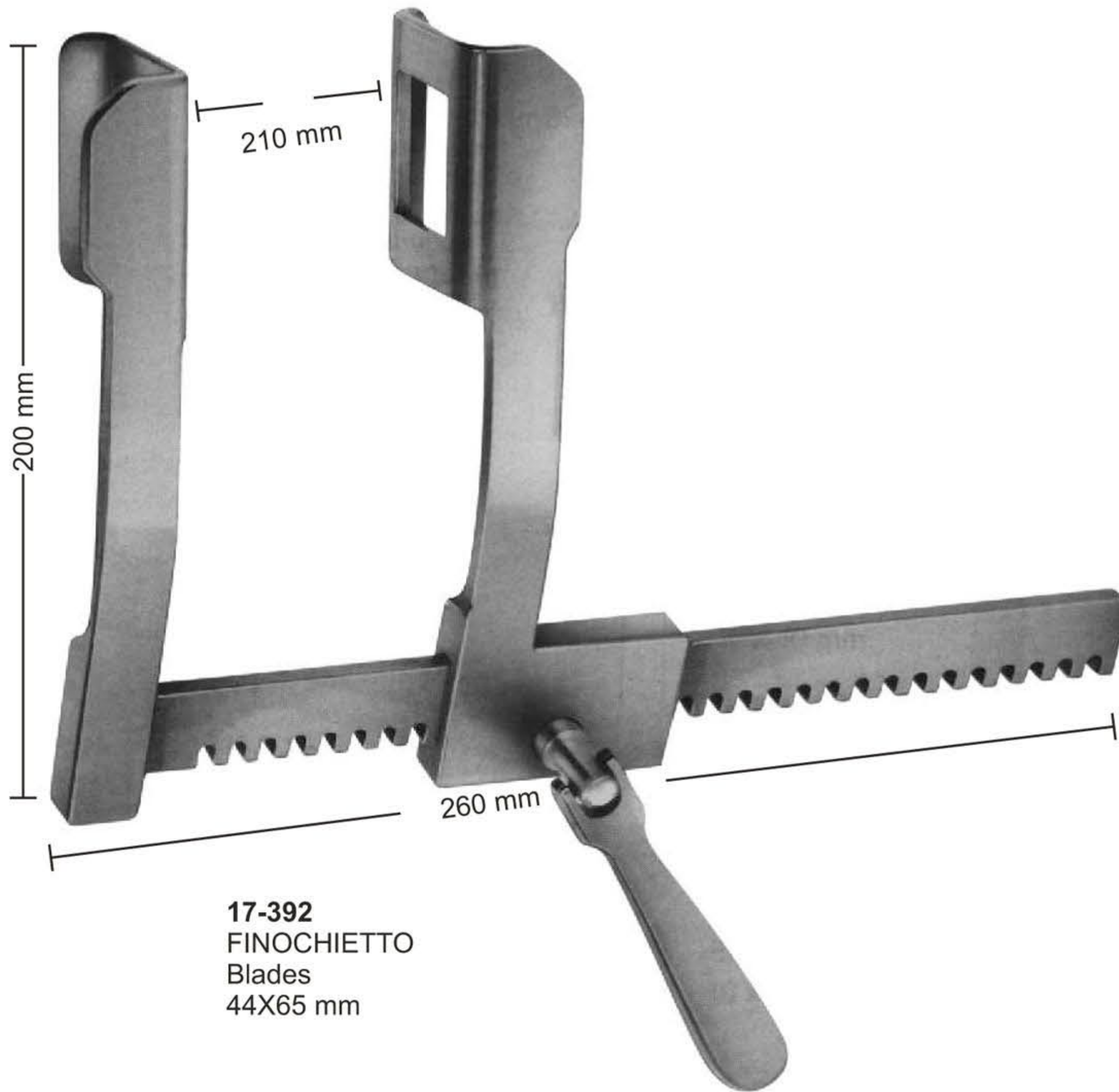



# Rib Spreaders

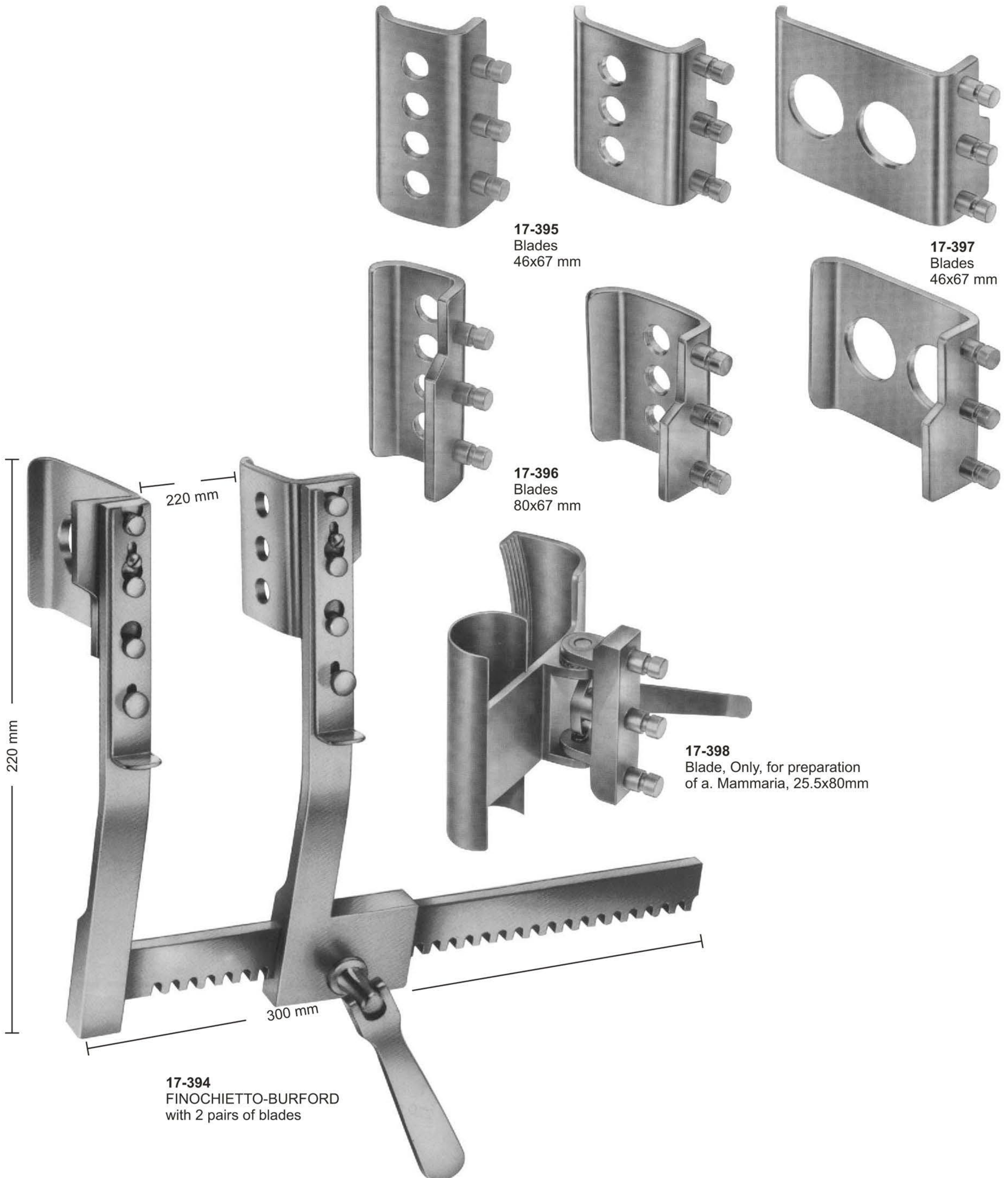

**17-395**  
Blades  
46x67 mm

**17-397**  
Blades  
46x67 mm

**17-396**  
Blades  
80x67 mm

**17-398**  
Blade, Only, for preparation  
of a. Mammaria, 25.5x80mm

**17-394**  
FINOCHIETTO-BURFORD  
with 2 pairs of blades



**Rib Spreaders**

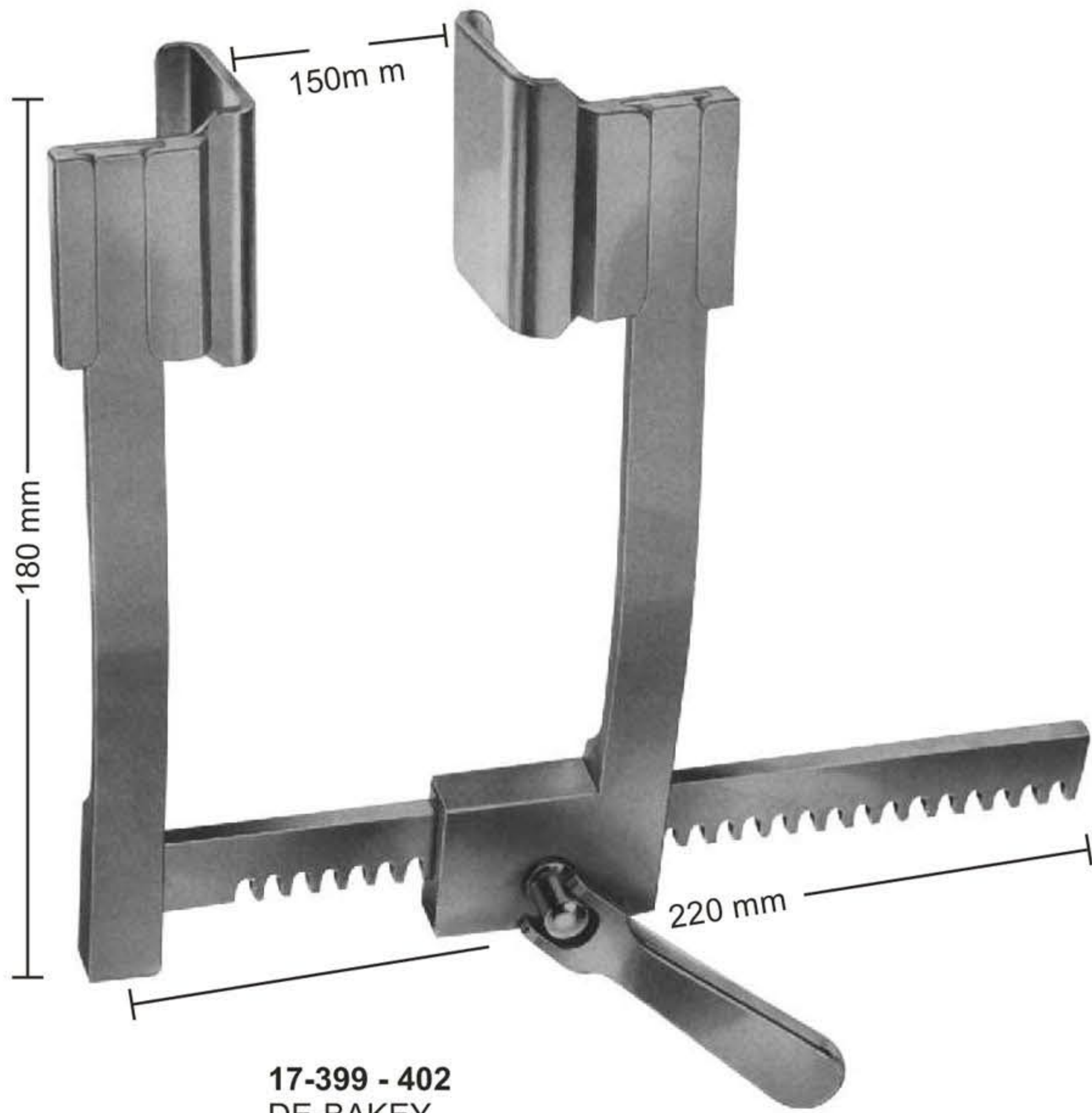

**17-399 - 402**  
DE-BAKEY  
with 3 pairs of blades

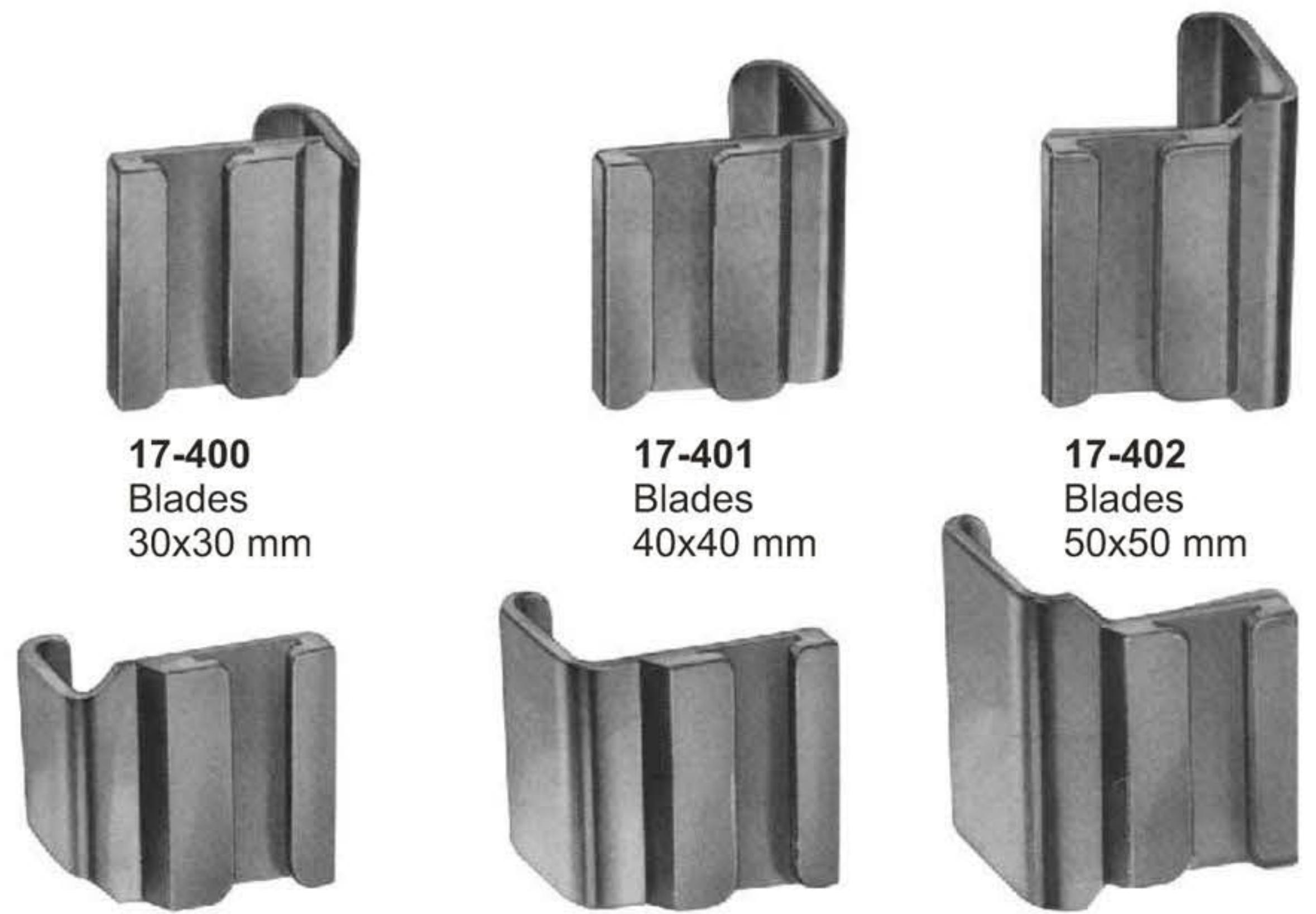

**17-400**  
Blades  
30x30 mm

**17-401**  
Blades  
40x40 mm

**17-402**  
Blades  
50x50 mm

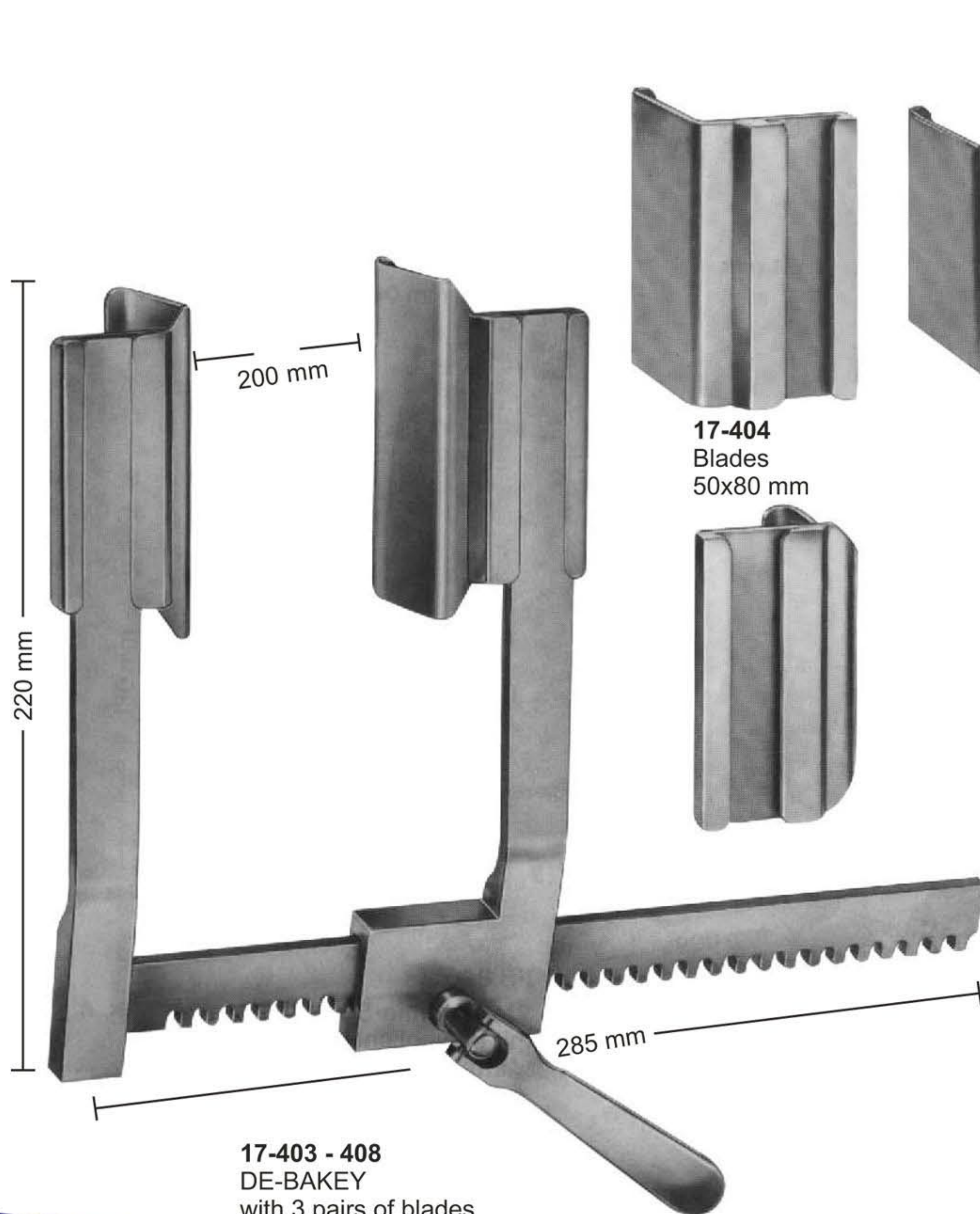

**17-403 - 408**  
DE-BAKEY  
with 3 pairs of blades

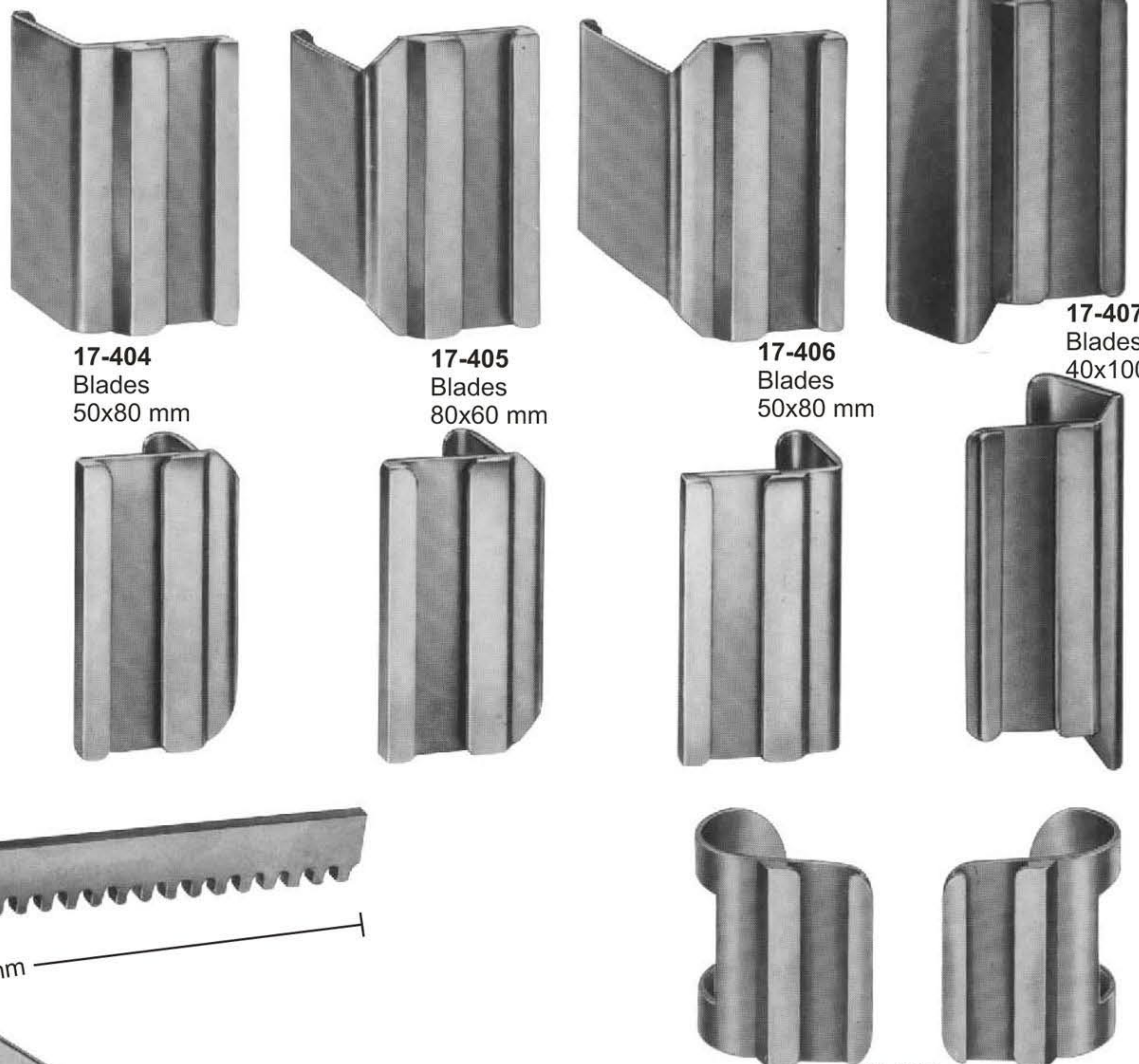

**17-404**  
Blades  
50x80 mm

**17-405**  
Blades  
80x60 mm

**17-406**  
Blades  
50x80 mm

**17-407**  
Blades  
40x100 mm

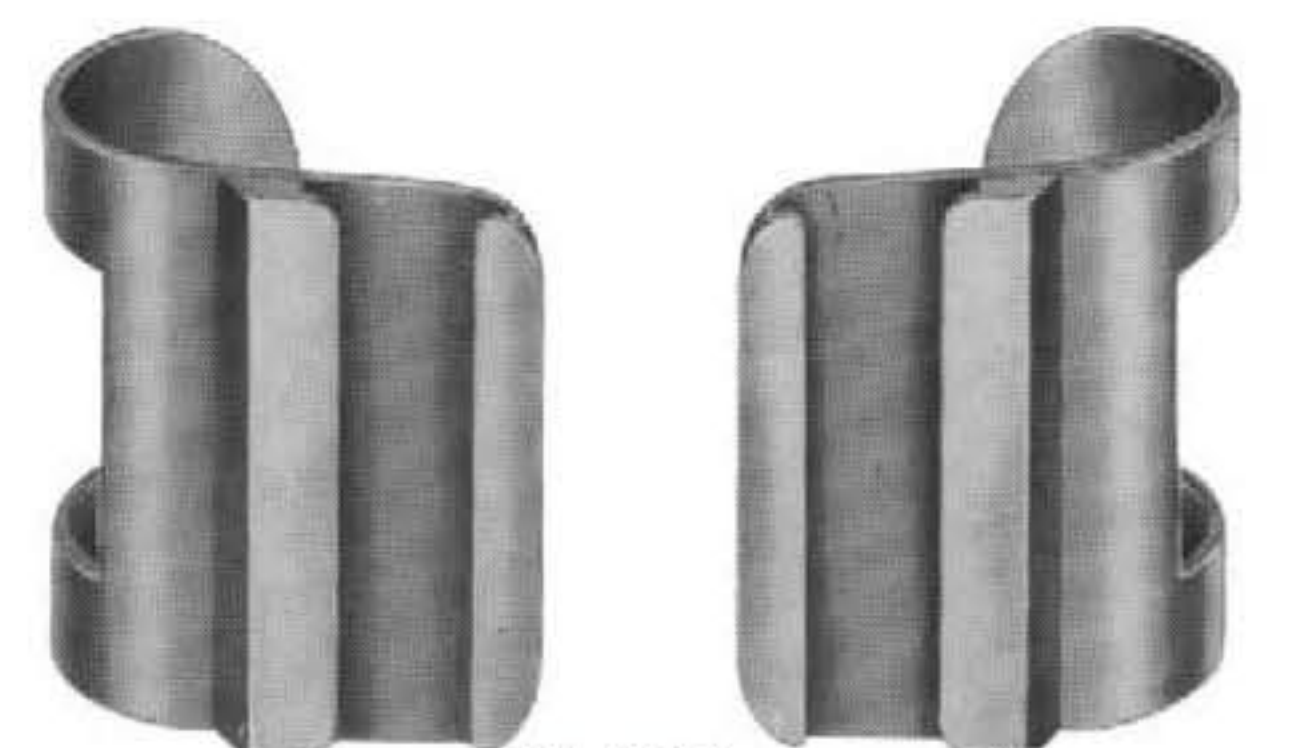

**17-408**  
Sternotomy Blades  
50x660 mm



## Sternotomy Spreaders

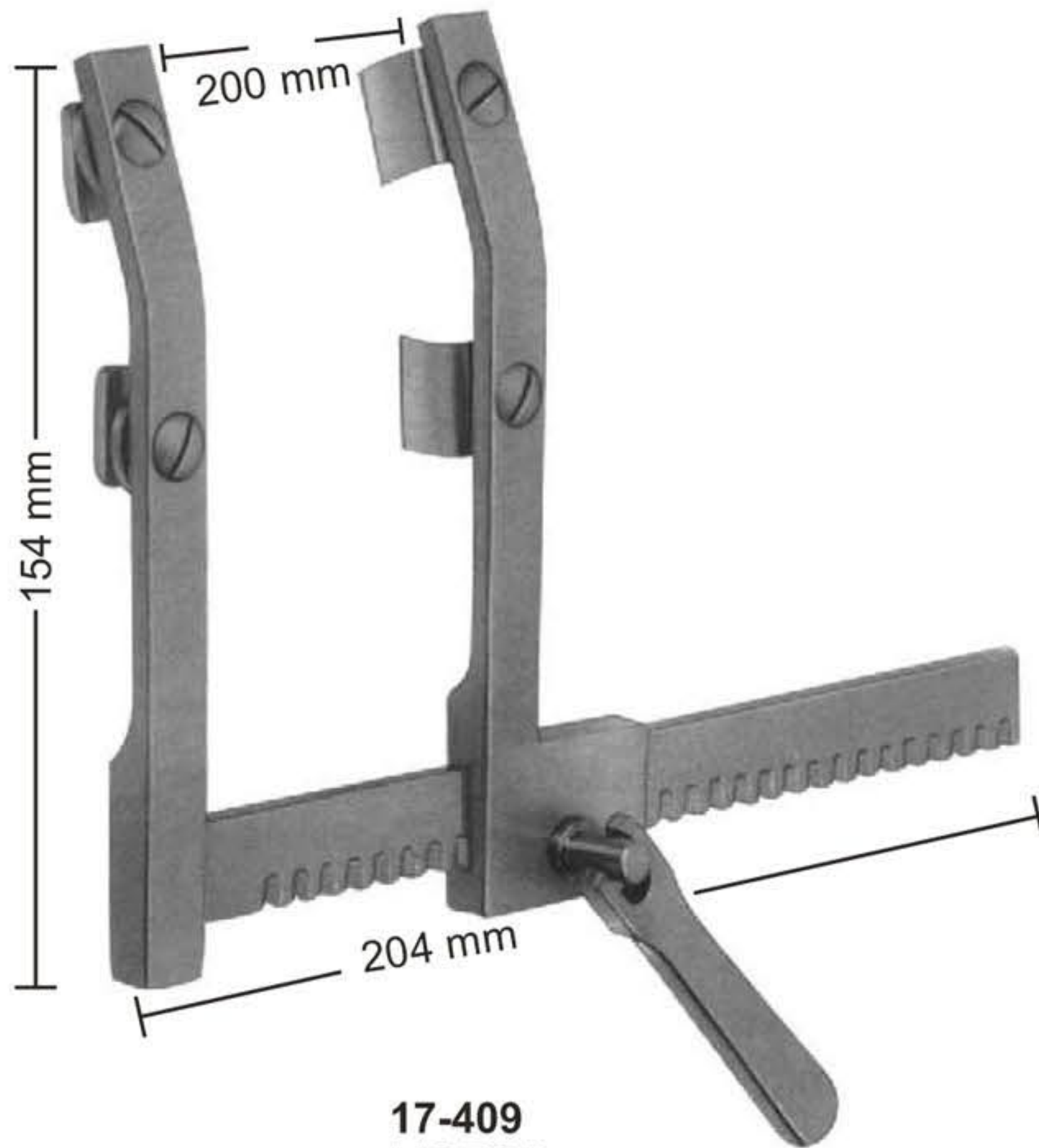

**17-409**  
MORSE  
Sternotomy spreader  
for children, with moveable  
double, each blade  
12x20 mm

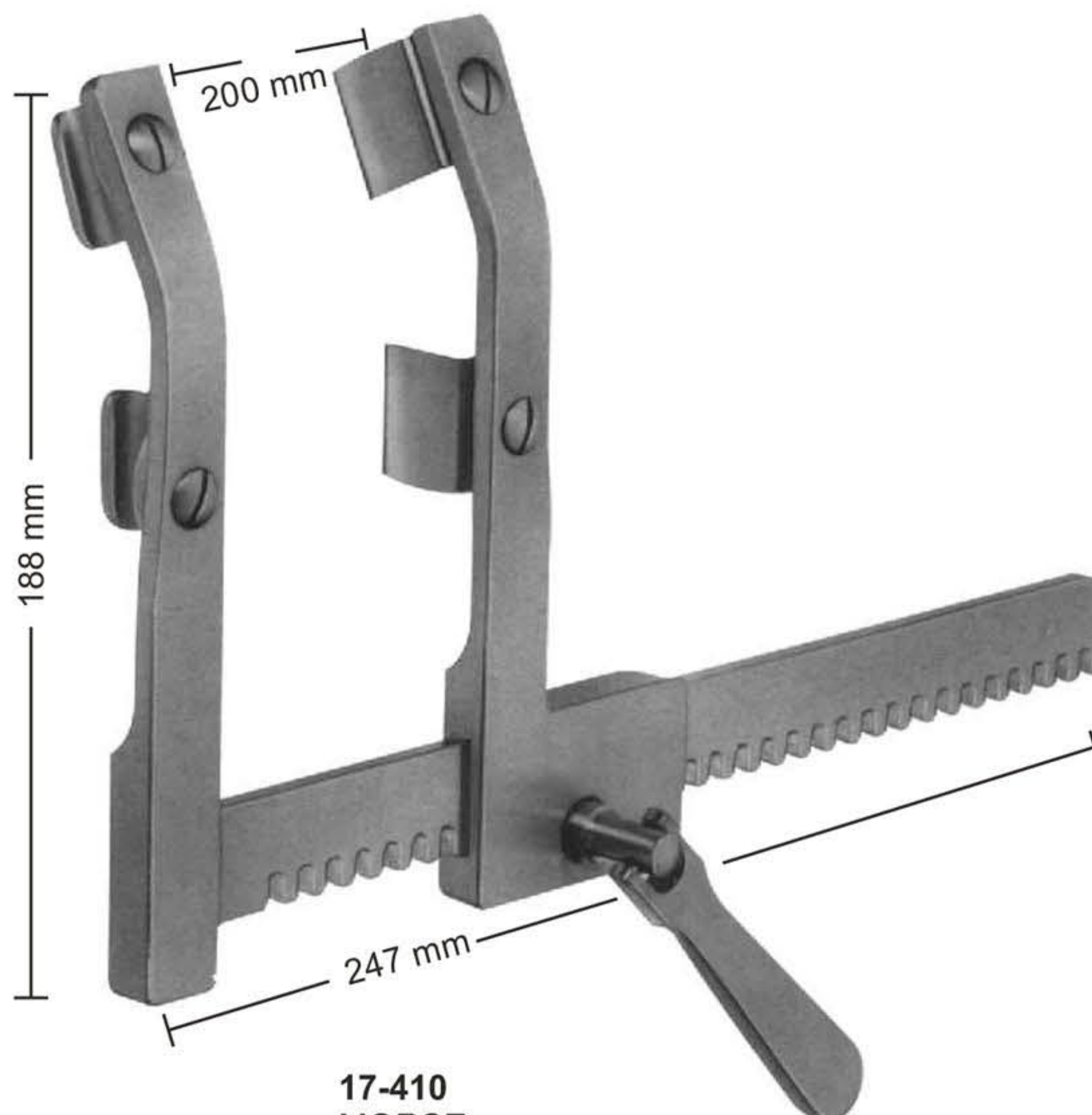

**17-410**  
MORSE  
Sternotomy spreader  
for adults, with moveable  
double, each blade  
19x19 mm



## Sternotomy- Spreaders

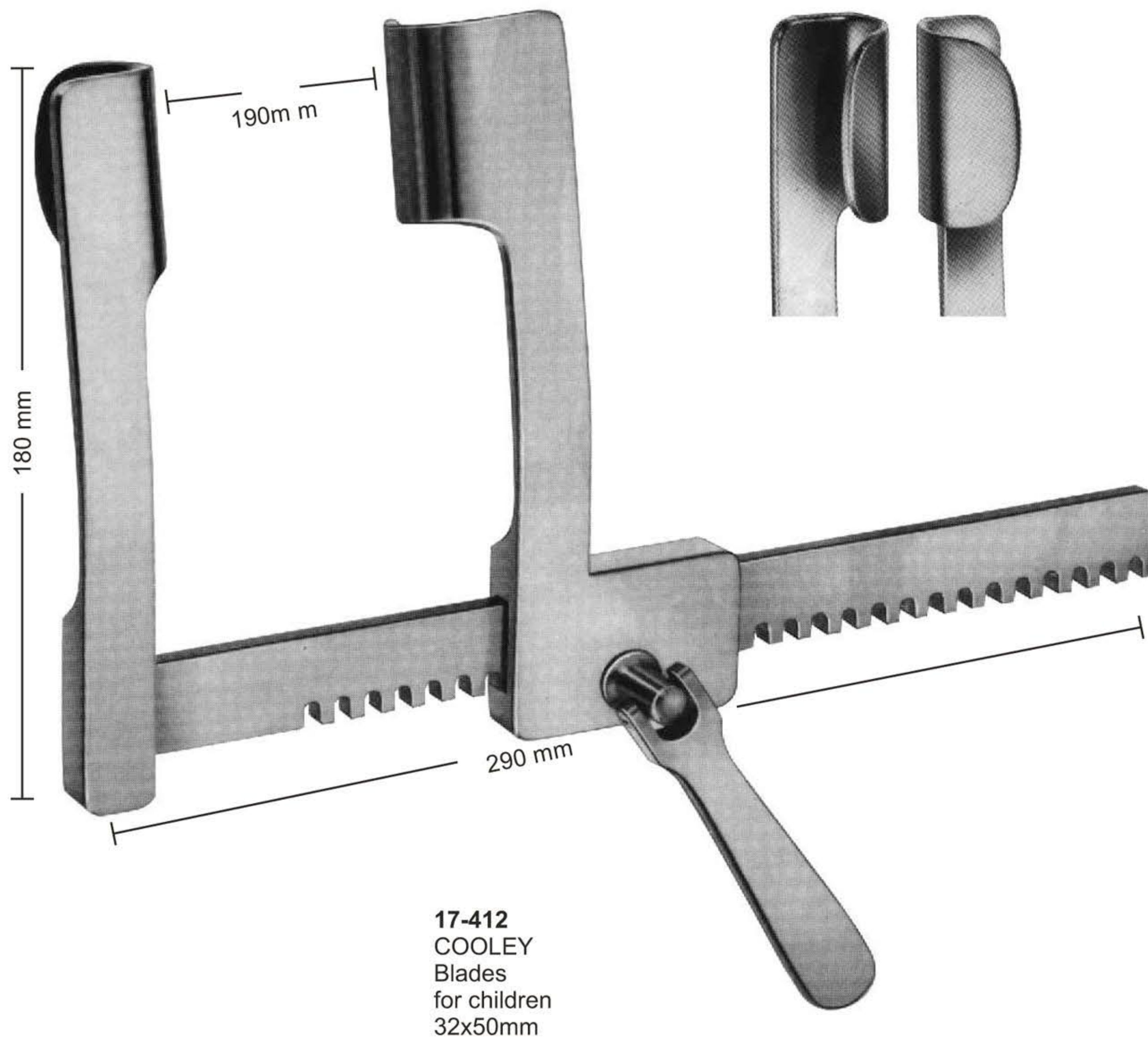
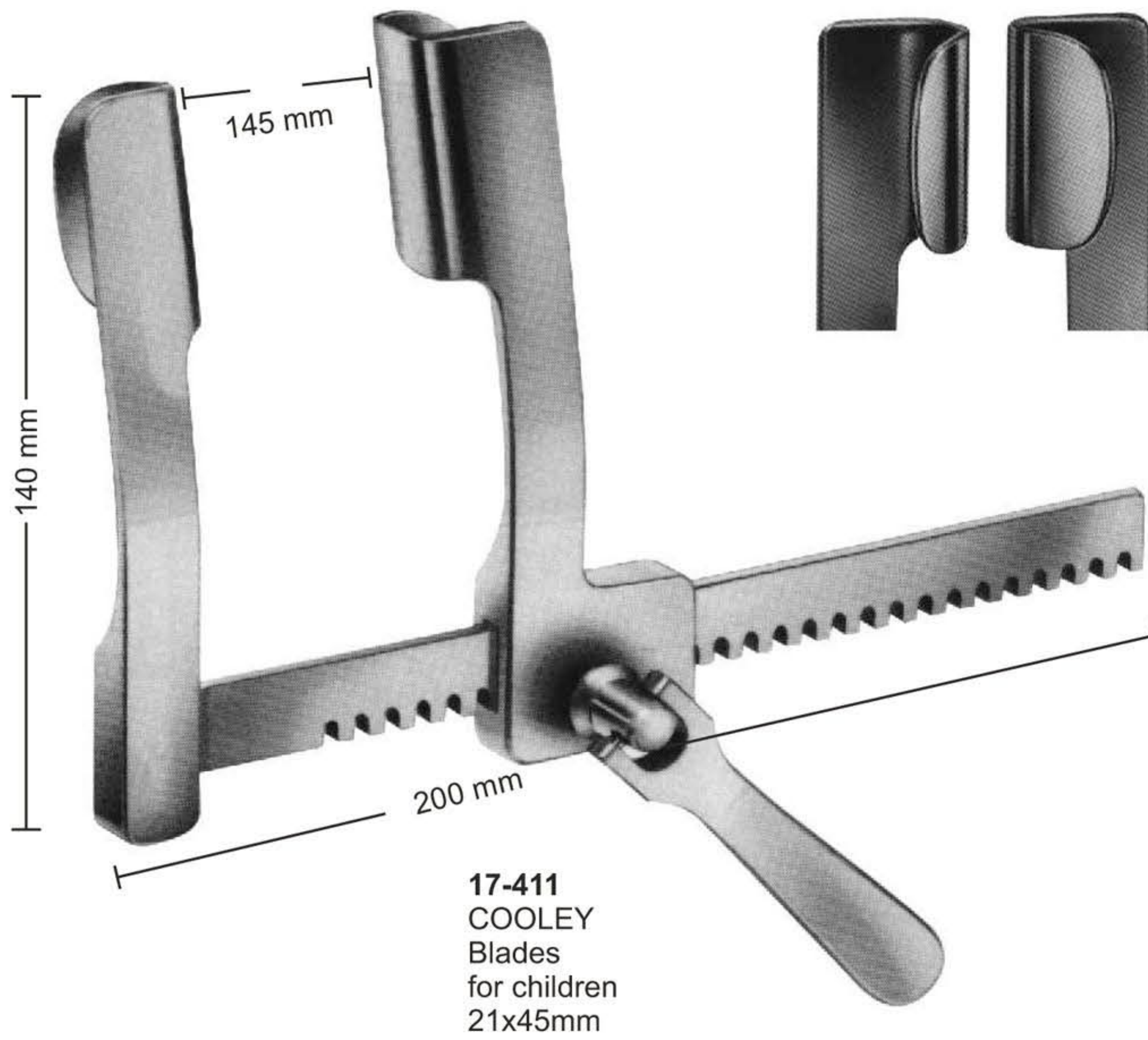



# Thoracic Retractors



**17-414**  
Blades  
75x75 mm



**17-415**  
Blades  
42x65 mm

Blades with Ball Snap System  
Delivery: in Pairs

- 17-413 - 415**  
Thoraxsperrer (Mercedes-Sperrer)  
complete consisting of:  
**17-413** Retractor only  
**17-414** 1 Pair of blades 42x65 mm  
**17-415** 1 Pair of blades 75x75 mm



## Rib Spreaders-and Contractors



**17-416**  
**SELLORS**  
Rib spreader-and contractor  
with swivel blades  
200 mm



**17-417**  
**BAILEY**  
150 mm

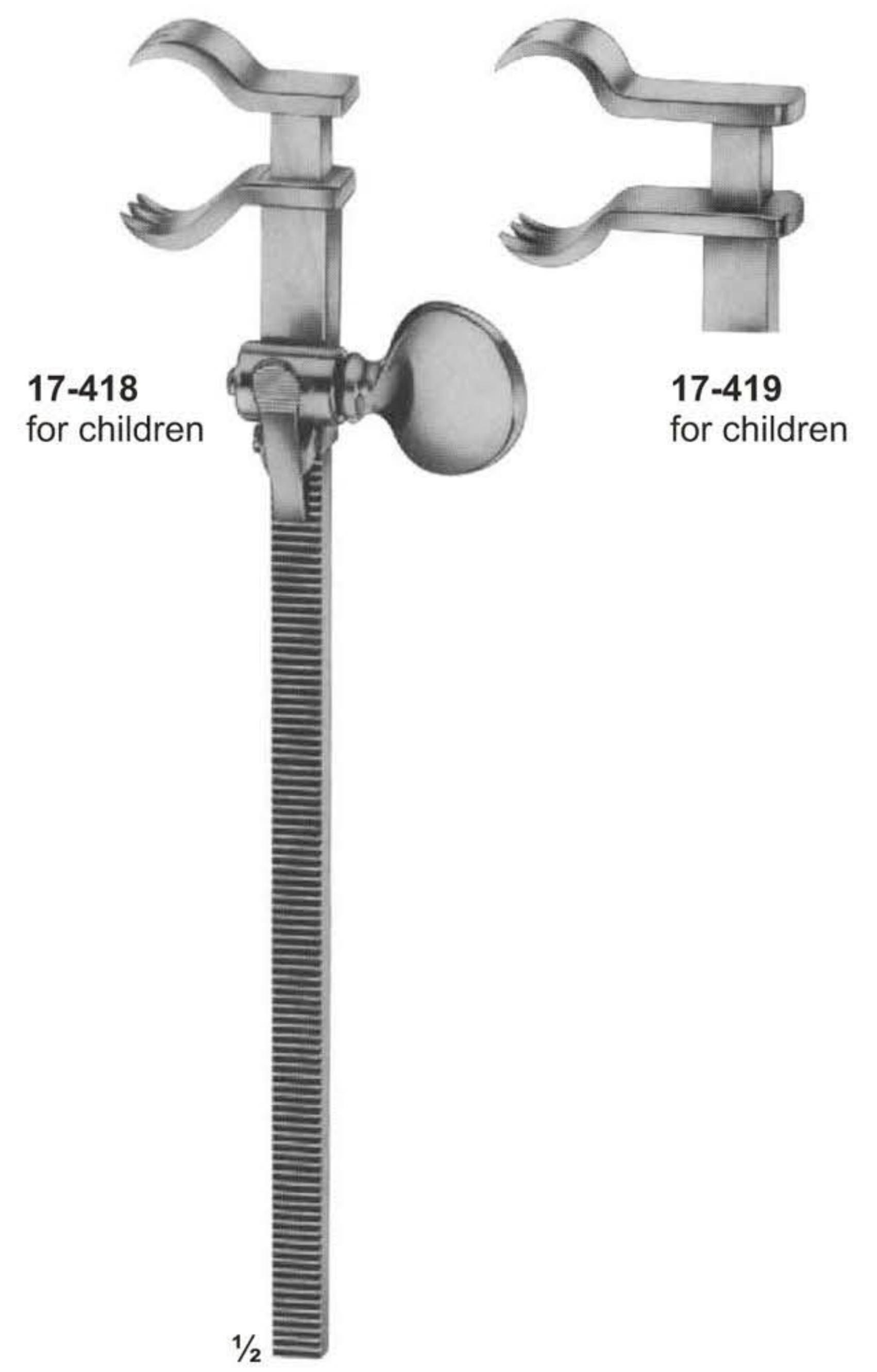

**17-418**  
for children

**17-419**  
for children

**17-418 - 419**  
**BAILEY**  
200 mm



# Rib Spreaders-and Contractors

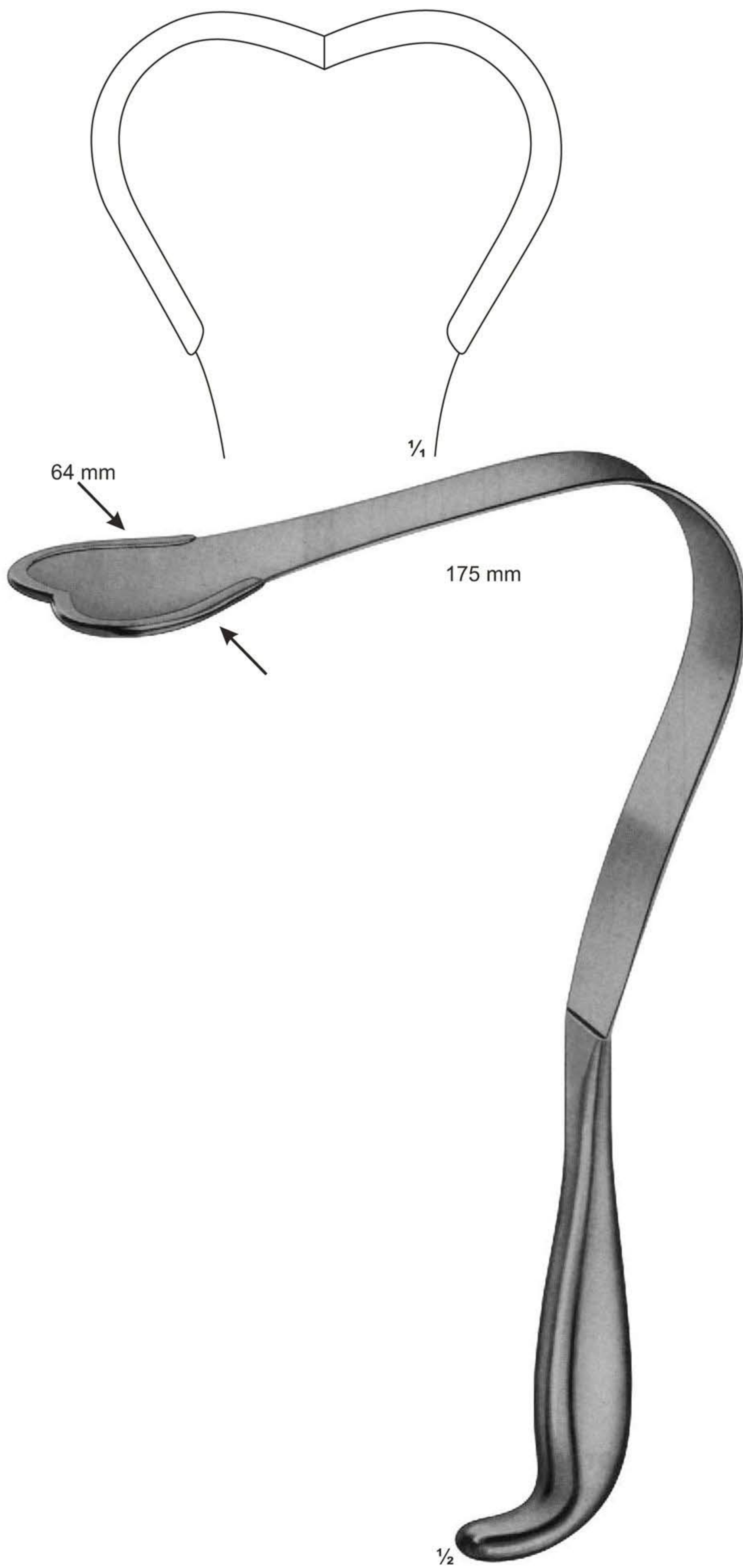

**17-420**  
HARRINGTON-PEMBERTON  
federnd/flexible  
295 mm

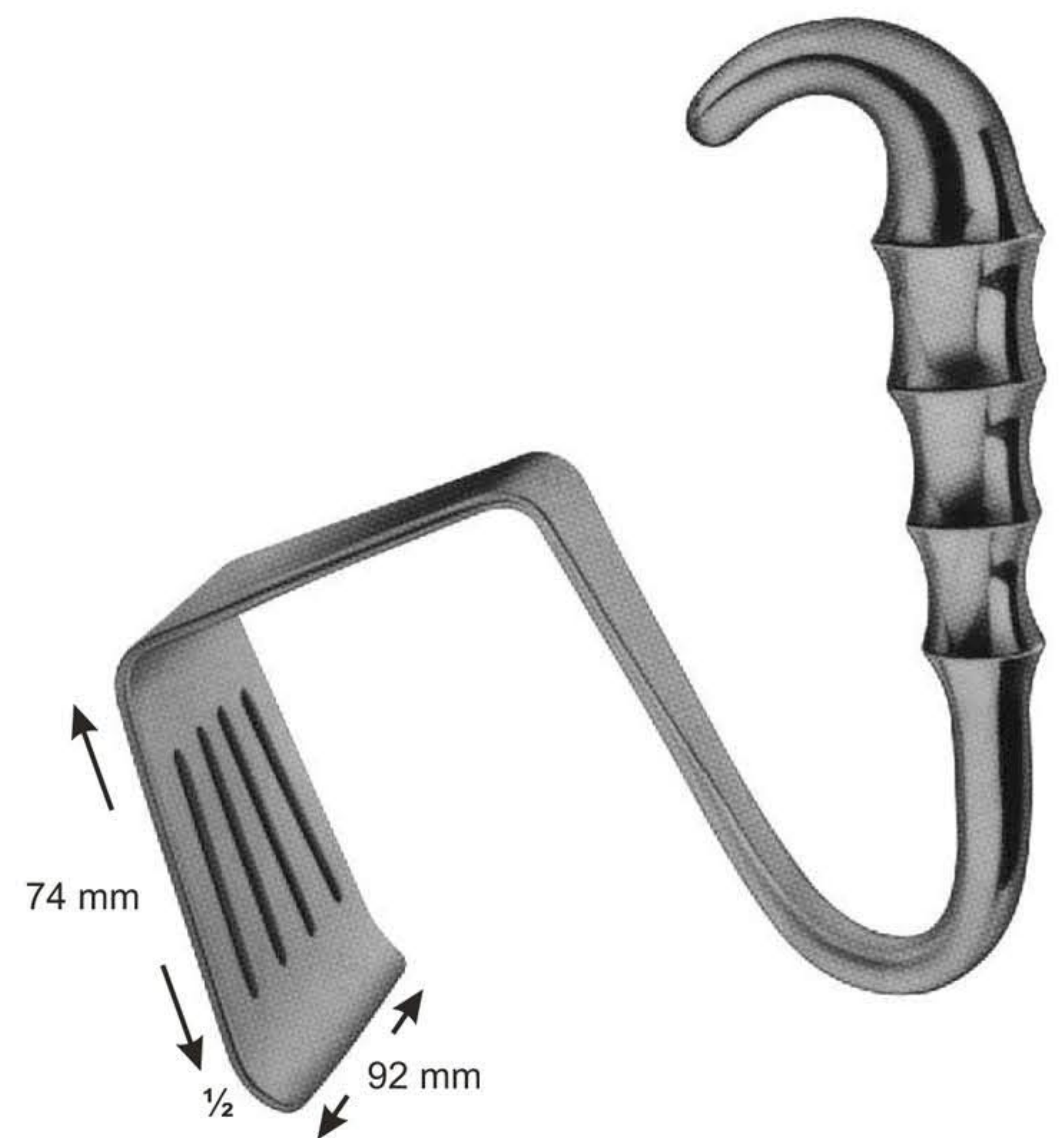

**17-421**  
DAVIDSON  
Scalpel haken



**Rib Spreaders-and Contractors**

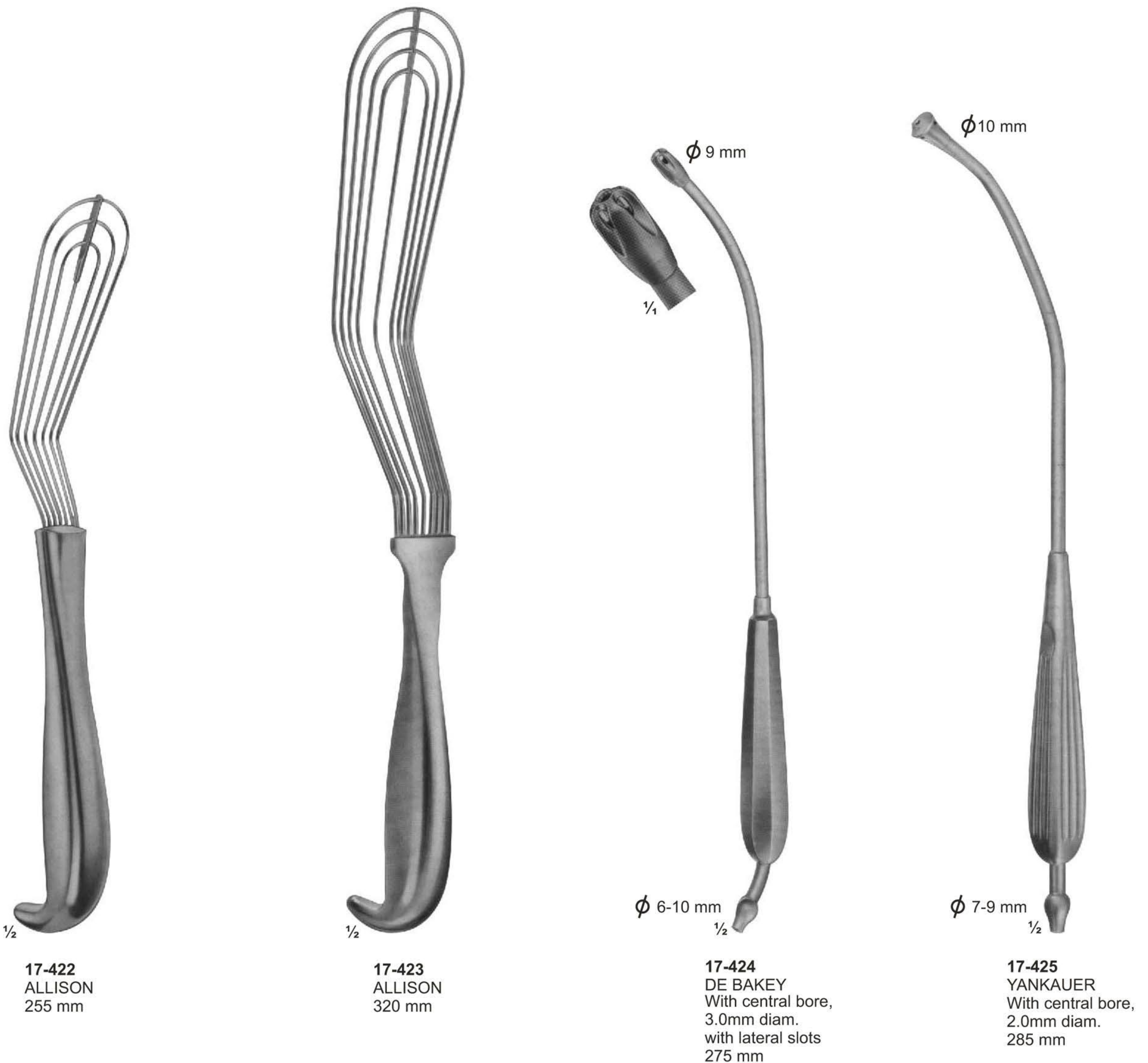



**Punches**

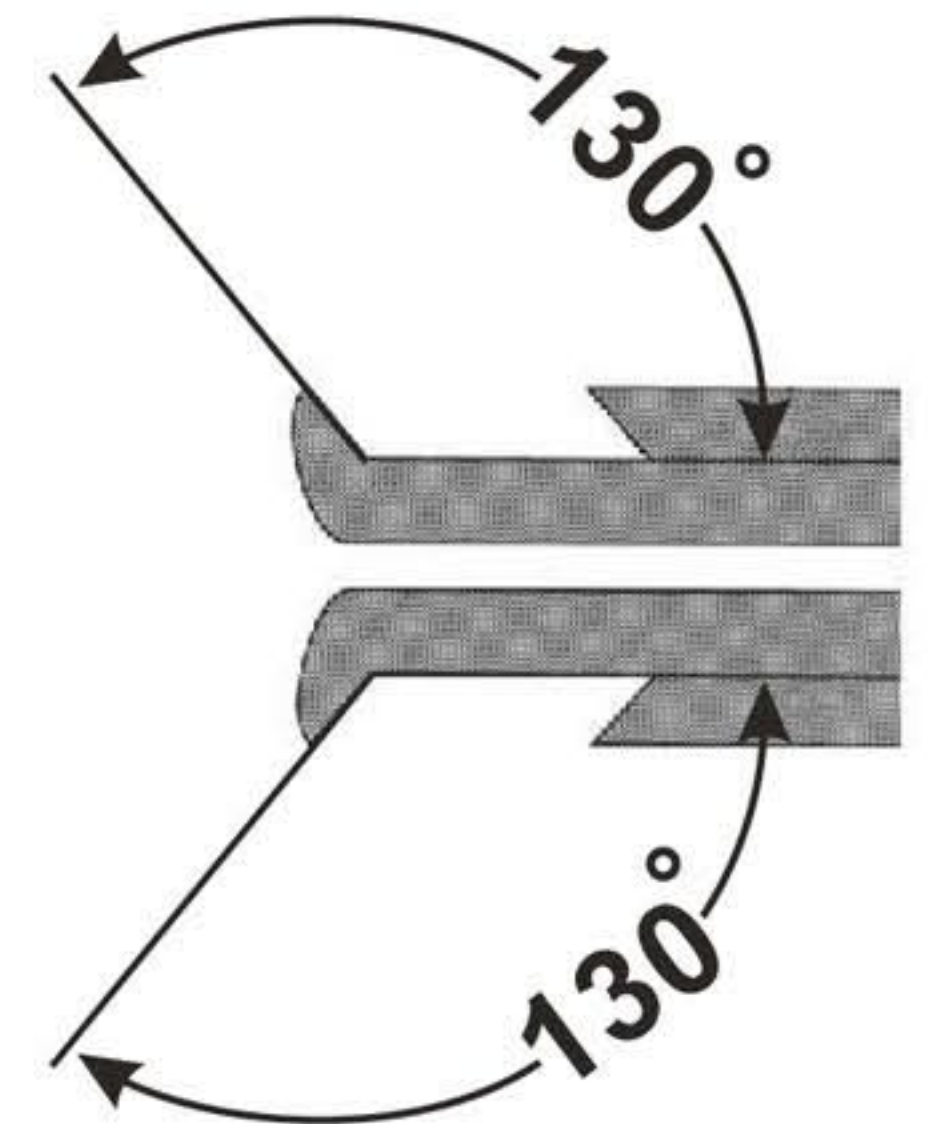
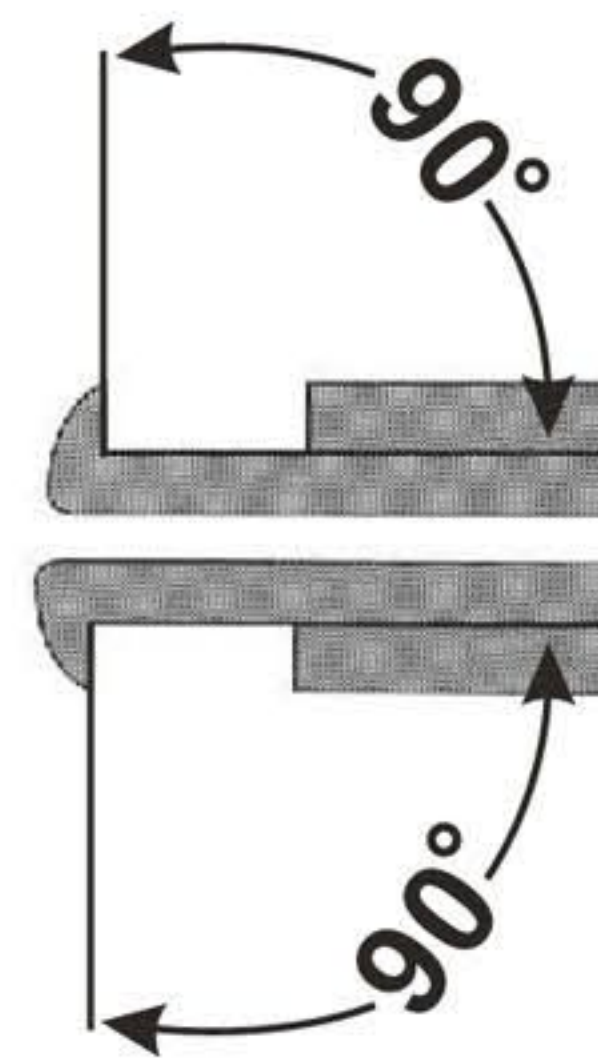
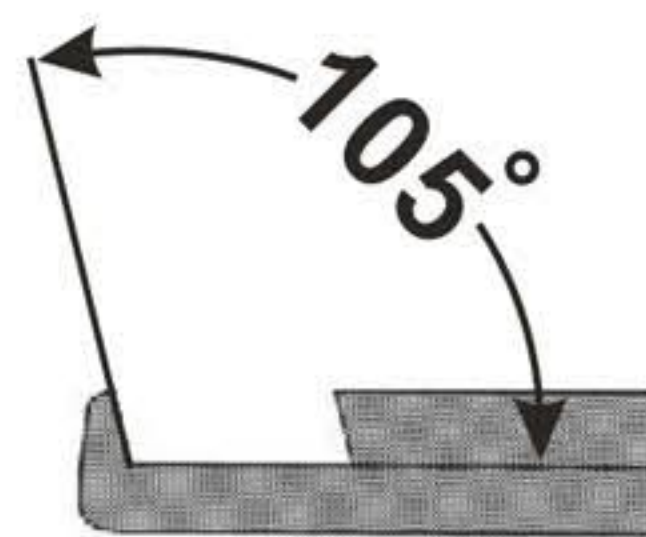

**90°** upwards cutting

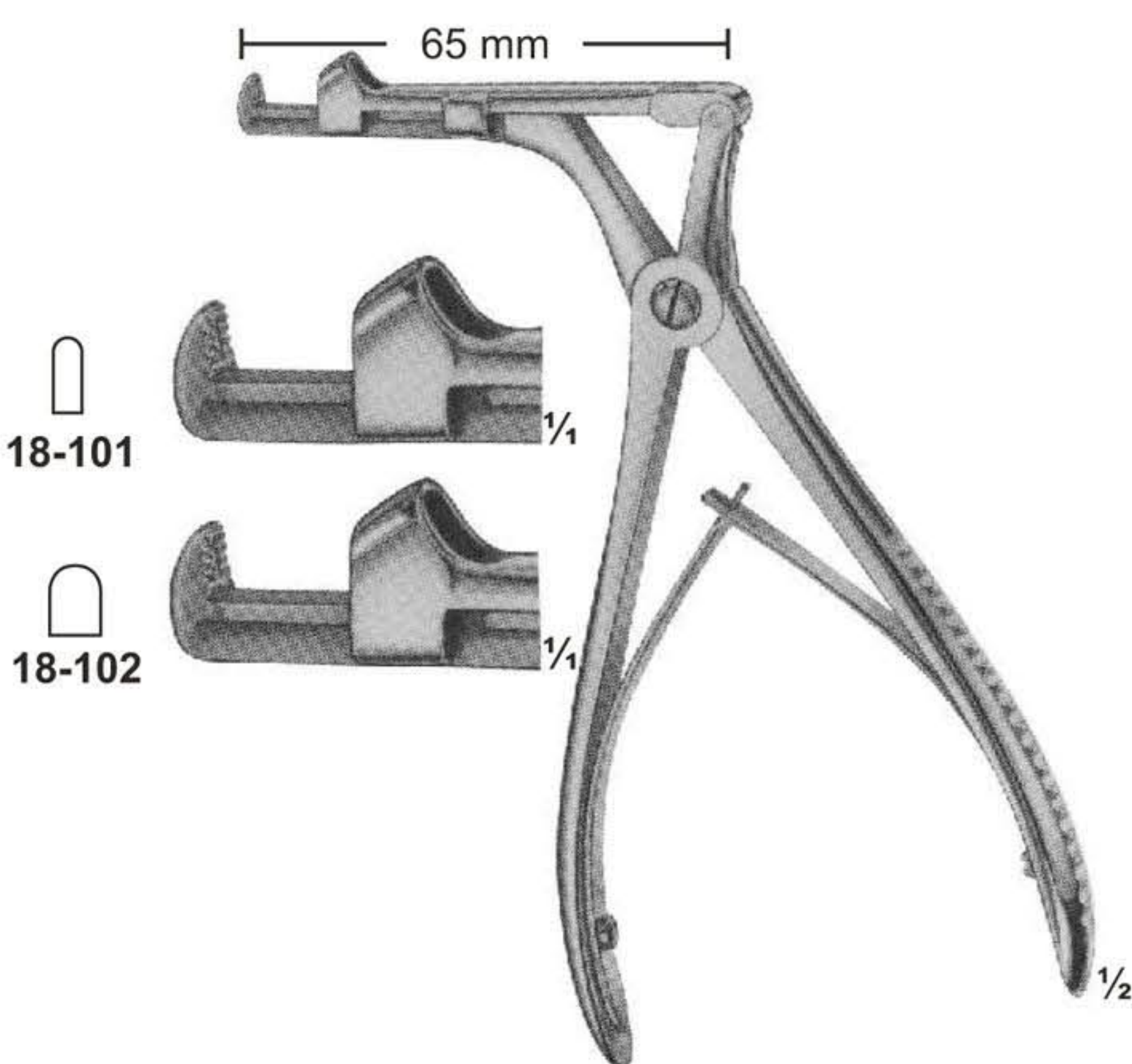

**18-101 - 102**  
CITELLI  
2 mm, 3,5 mm

**90°** upwards cutting

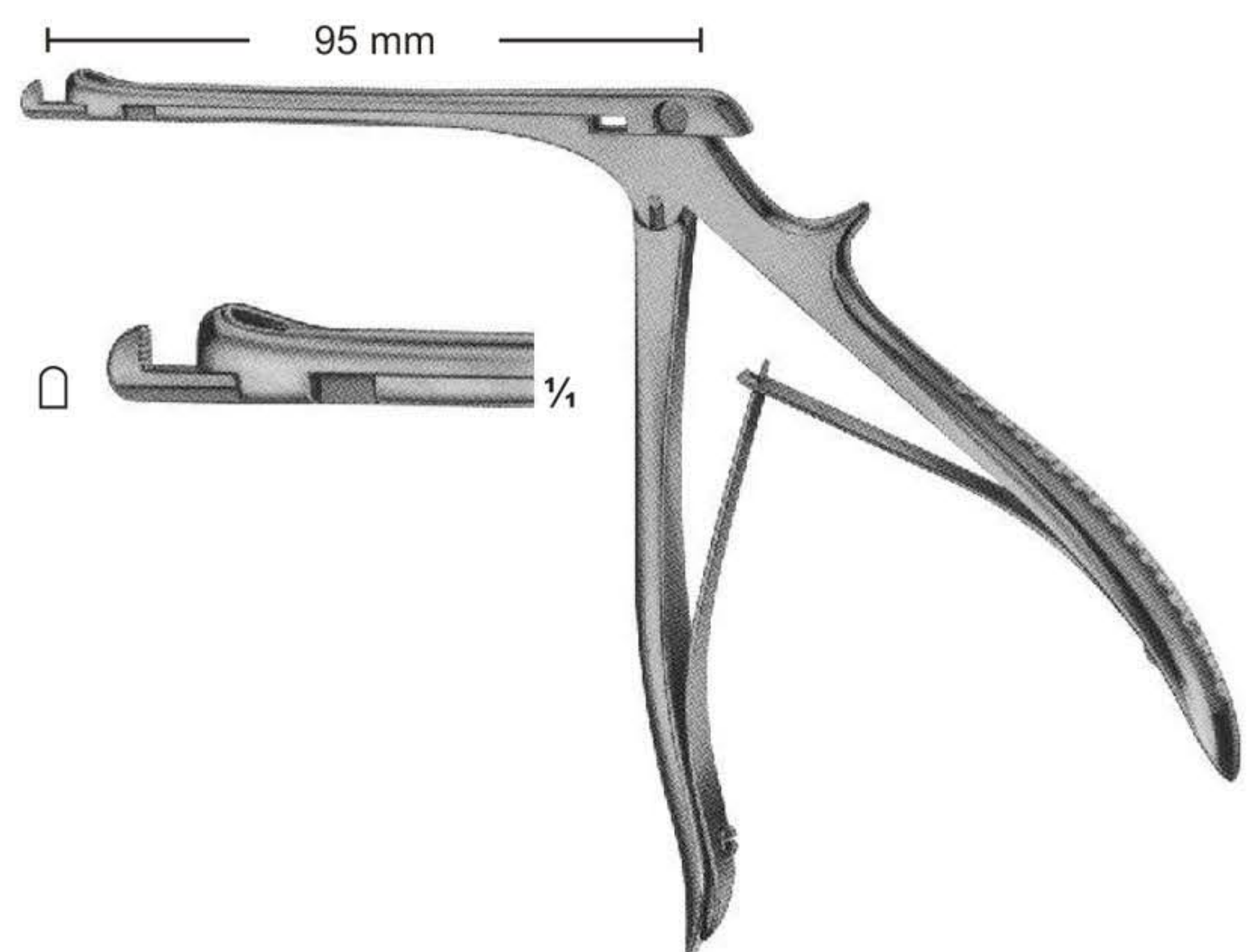

**18-103**  
CITELLI- BEYER  
1,8 mm



**Punches**

**90°** upwards cutting

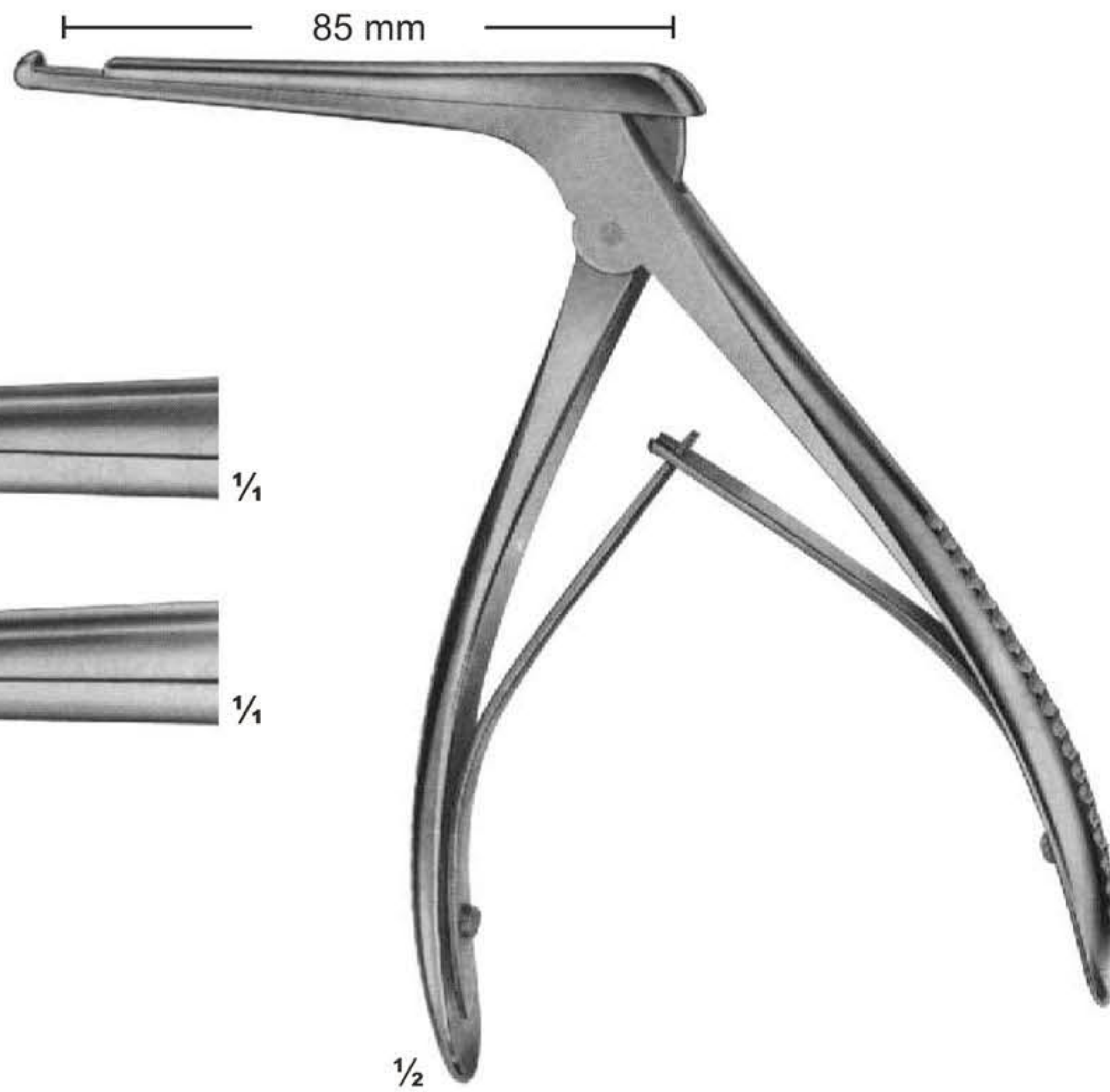

**18-104 - 105**  
KERRISON

**18-104**  
4 mm



**18-105**  
5 mm

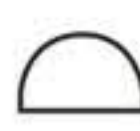

**90°** upwards cutting

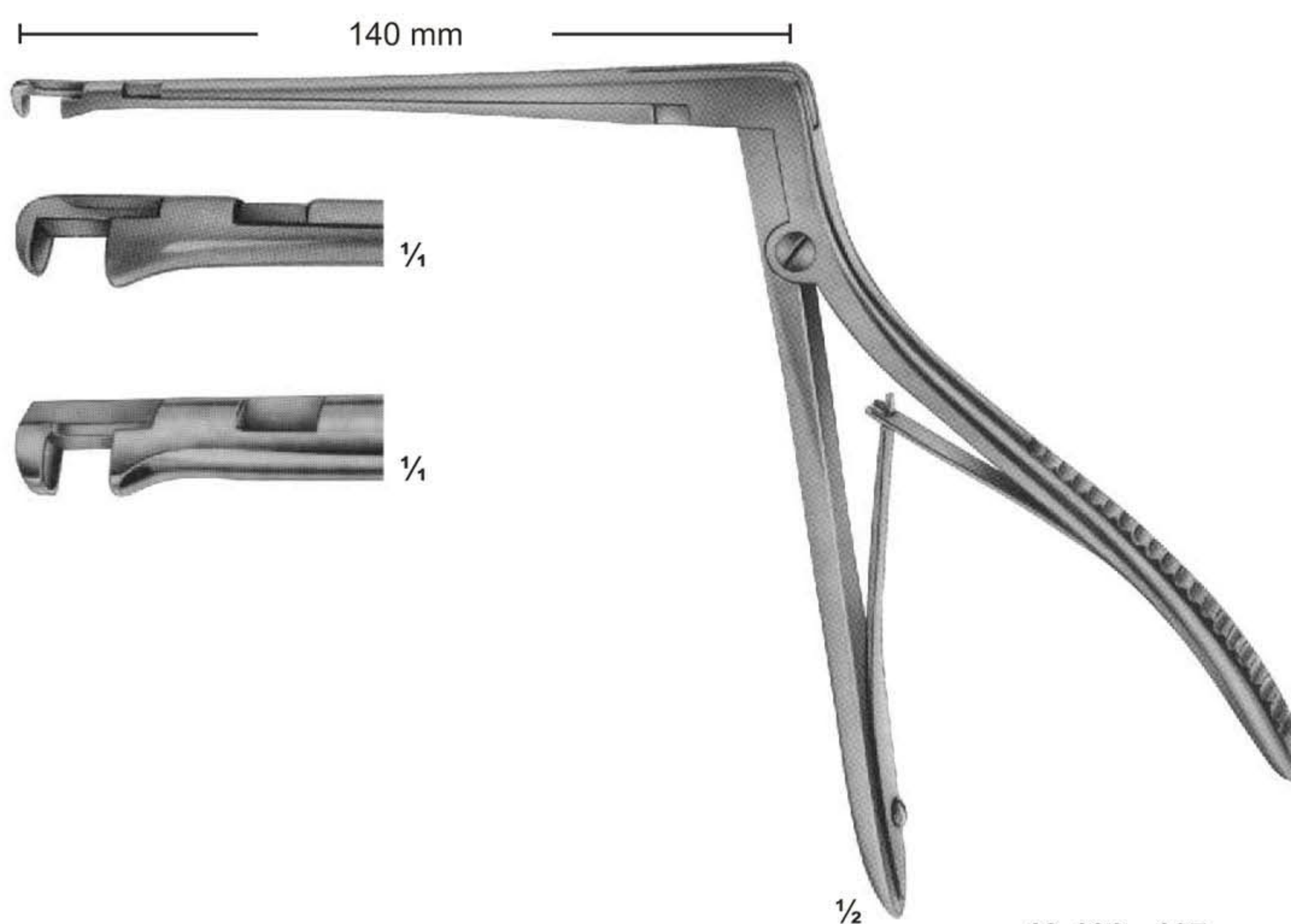

**18-106 - 107**  
HAJEK-KOFLER

**18-106**  
3,3 mm

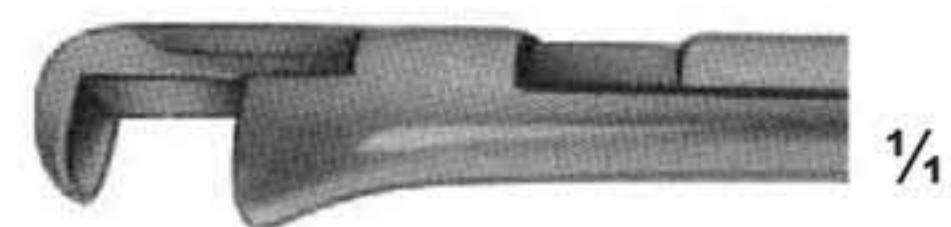

**18-107**  
4,0 mm

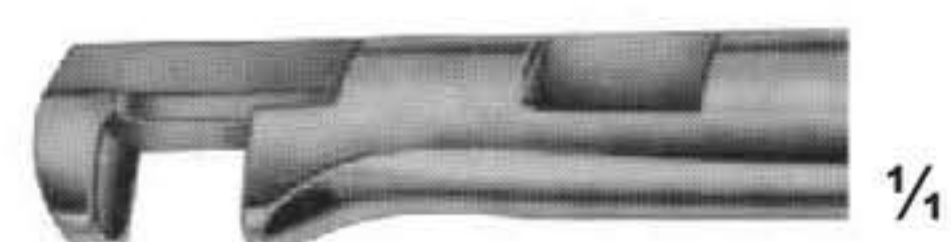





# Punches

**130°** upwards cutting

**18-108**  
1 mm 

**18-109**  
2 mm 

**18-110**  
3 mm 

**18-111**  
4 mm 

**18-112**  
5 mm 

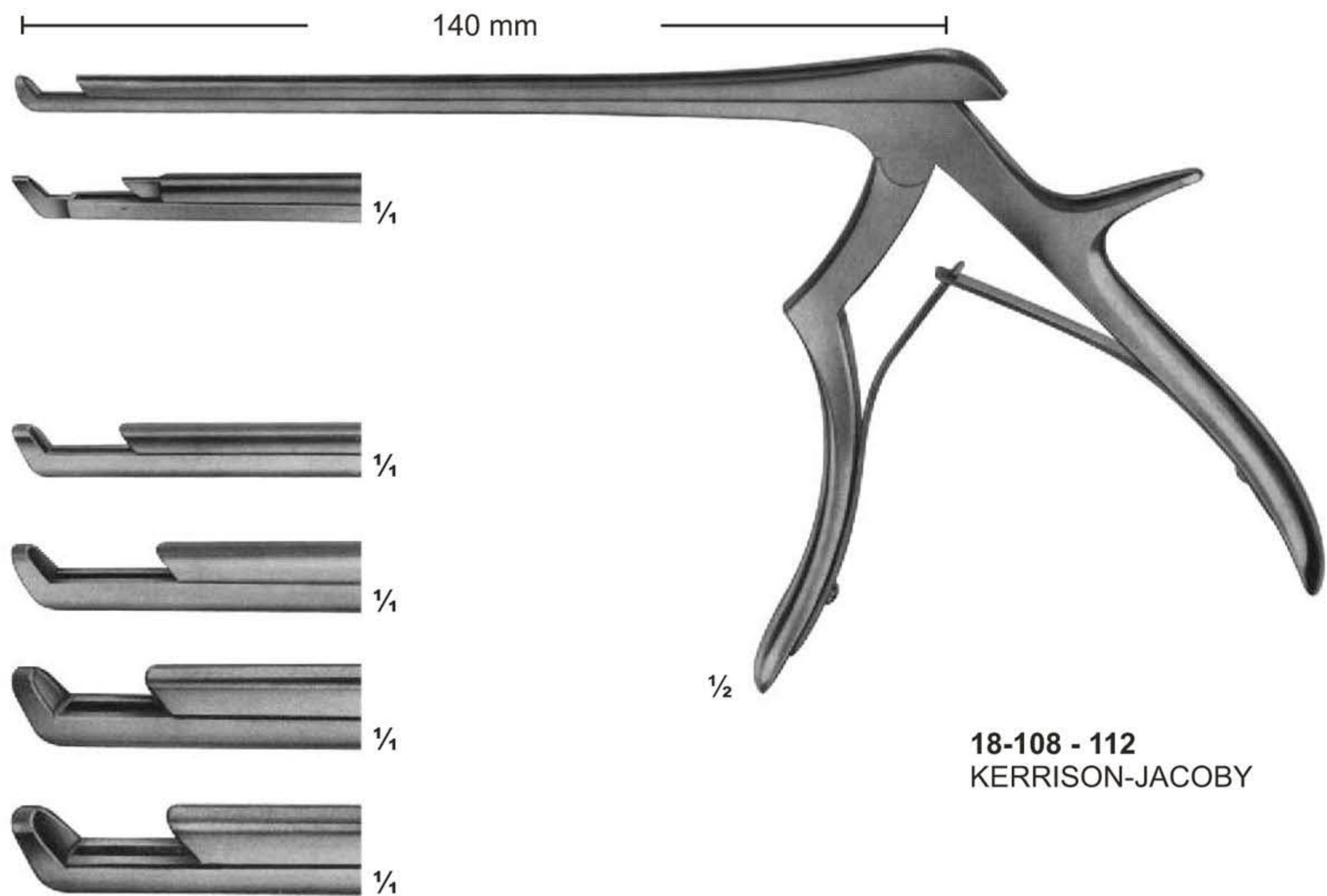

**90°** upwards cutting

**18-113**  
1 mm 

**18-114**  
2 mm 

FERRIS-SMITH-KERRISON

**18-115**  
3 mm 

**18-116**  
4 mm 

**18-117**  
5 mm 

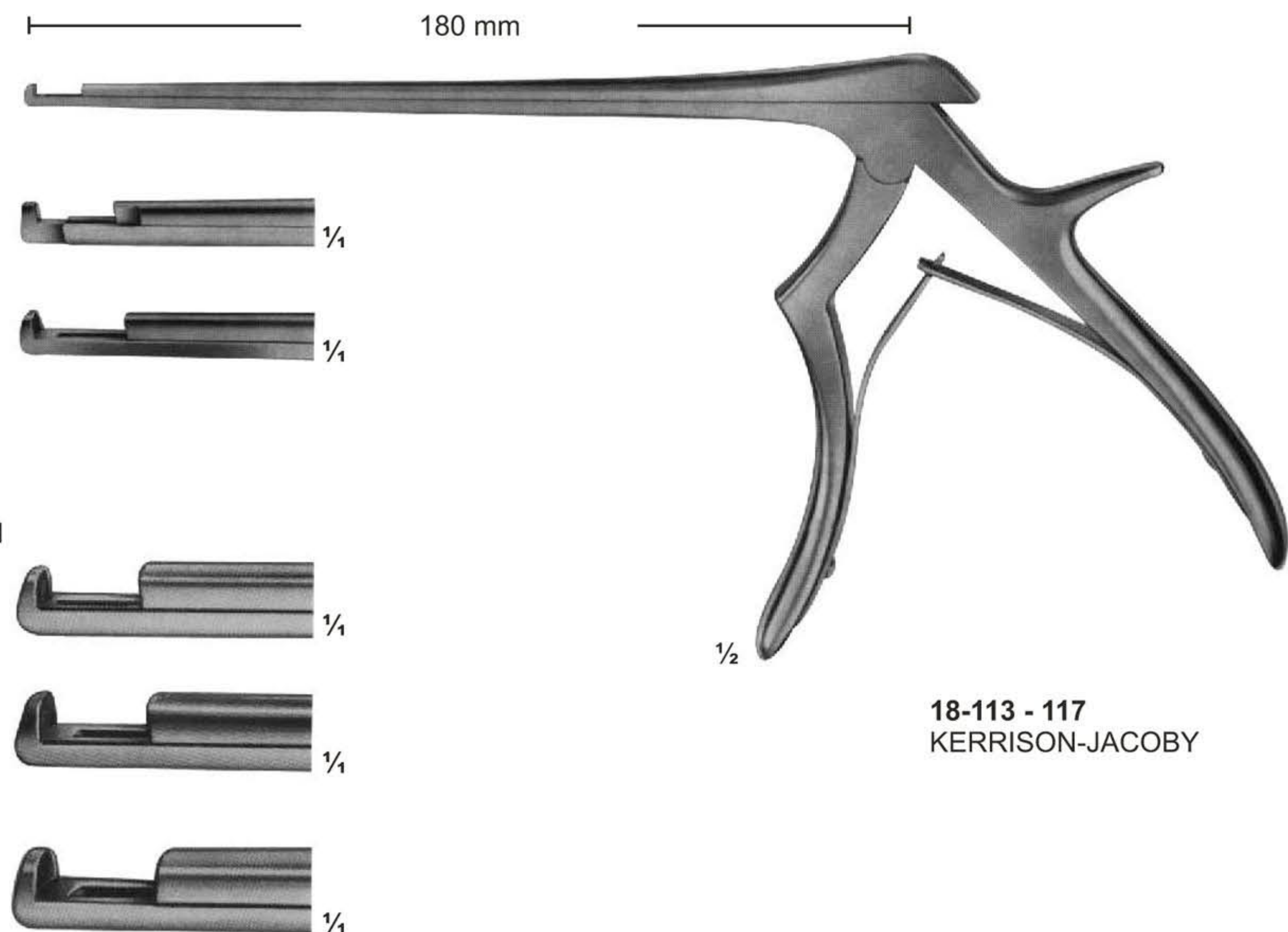



**Rongeurs**

Angled positions for rongeurs

- 18-118**  
3,0 mm
- 18-119**  
3,6 mm
- 18-120**  
4,2 mm
- 18-121**  
4,8 mm
- 18-122**  
5,8 mm

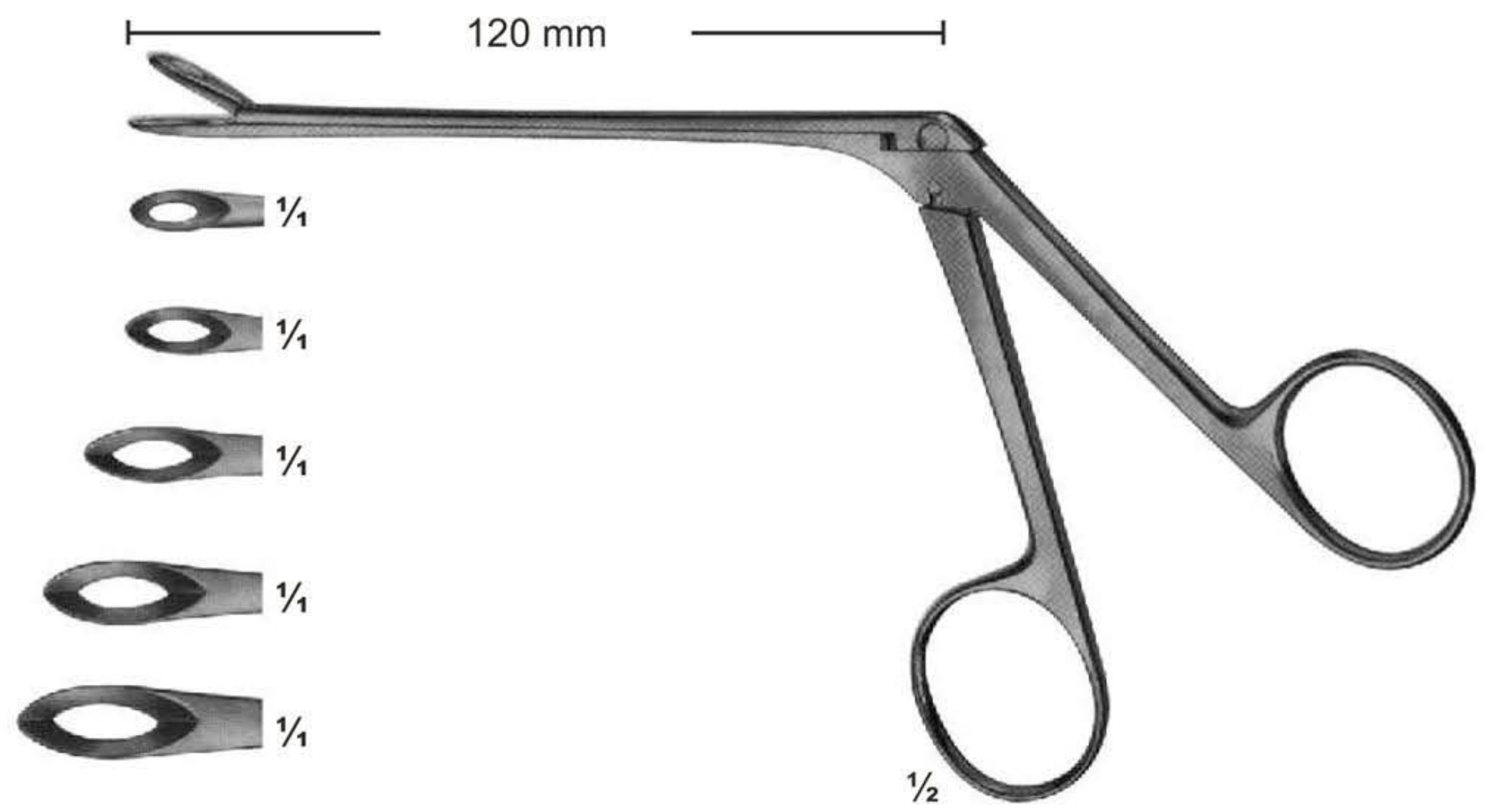

**18-118 - 122**  
WEIL-BLAKESLEY

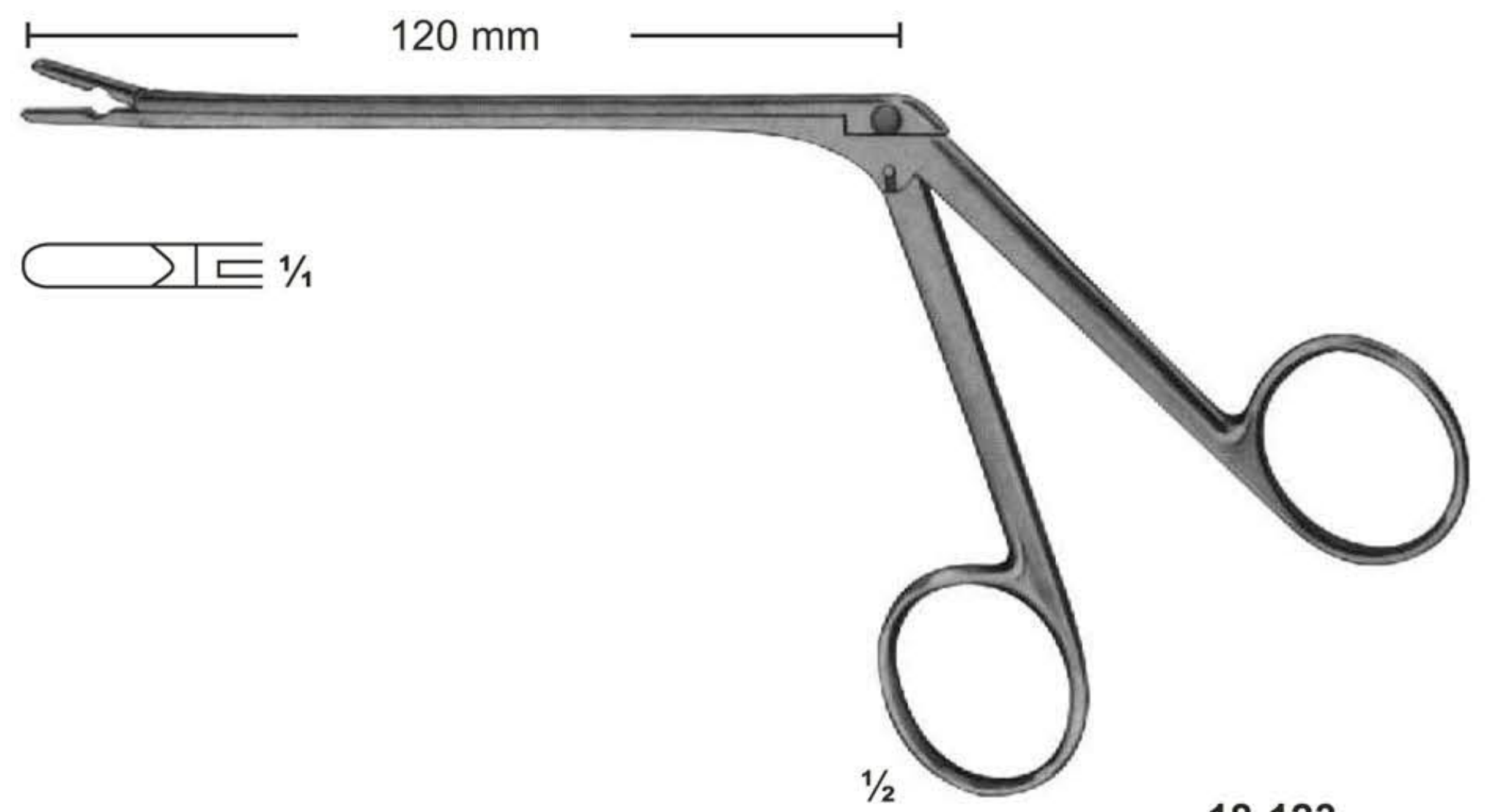

**18-123**  
TAKAHASHI  
3 mm

**130°**

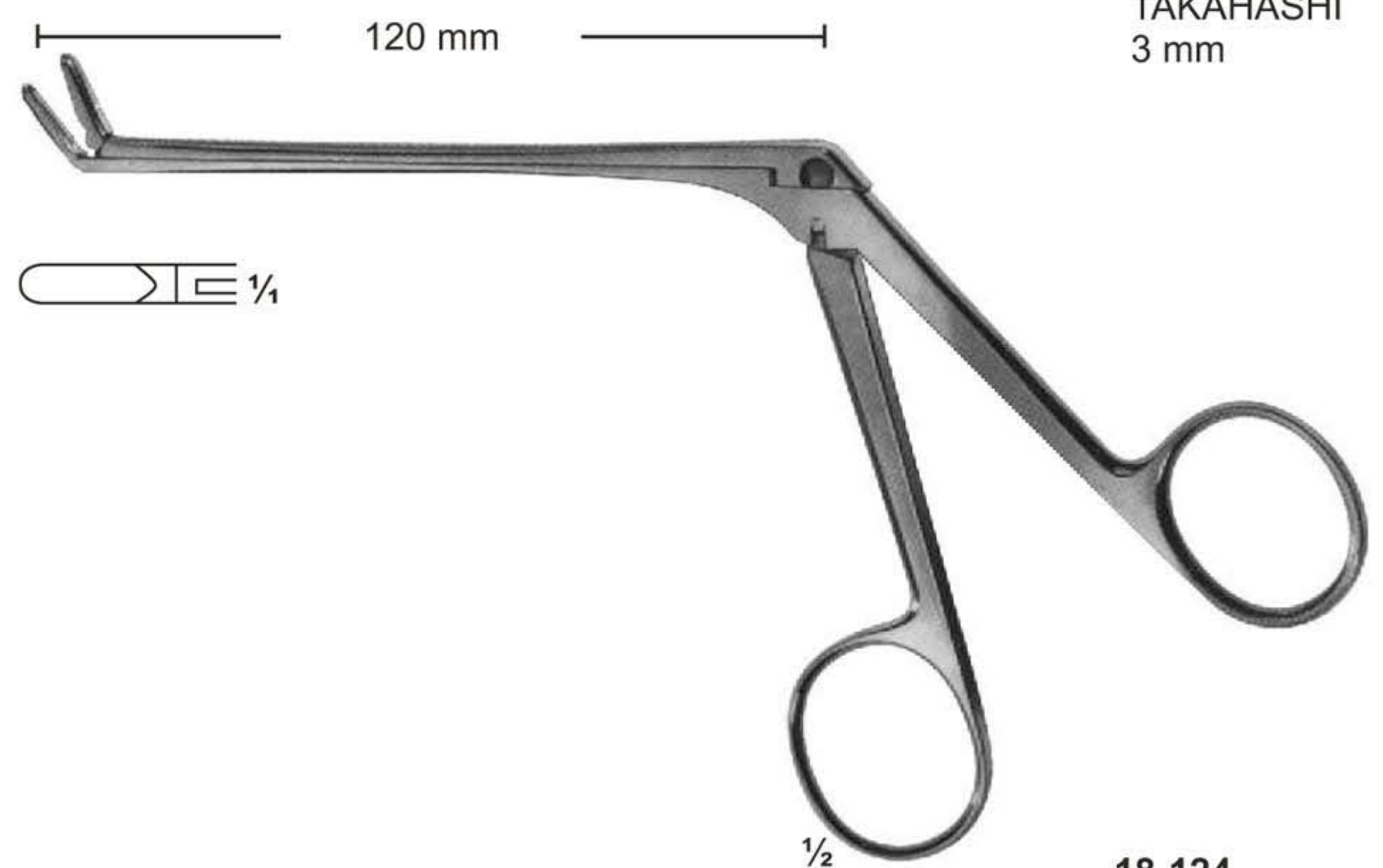

**18-124**  
TAKAHASHI  
3 mm



**Rongeurs**

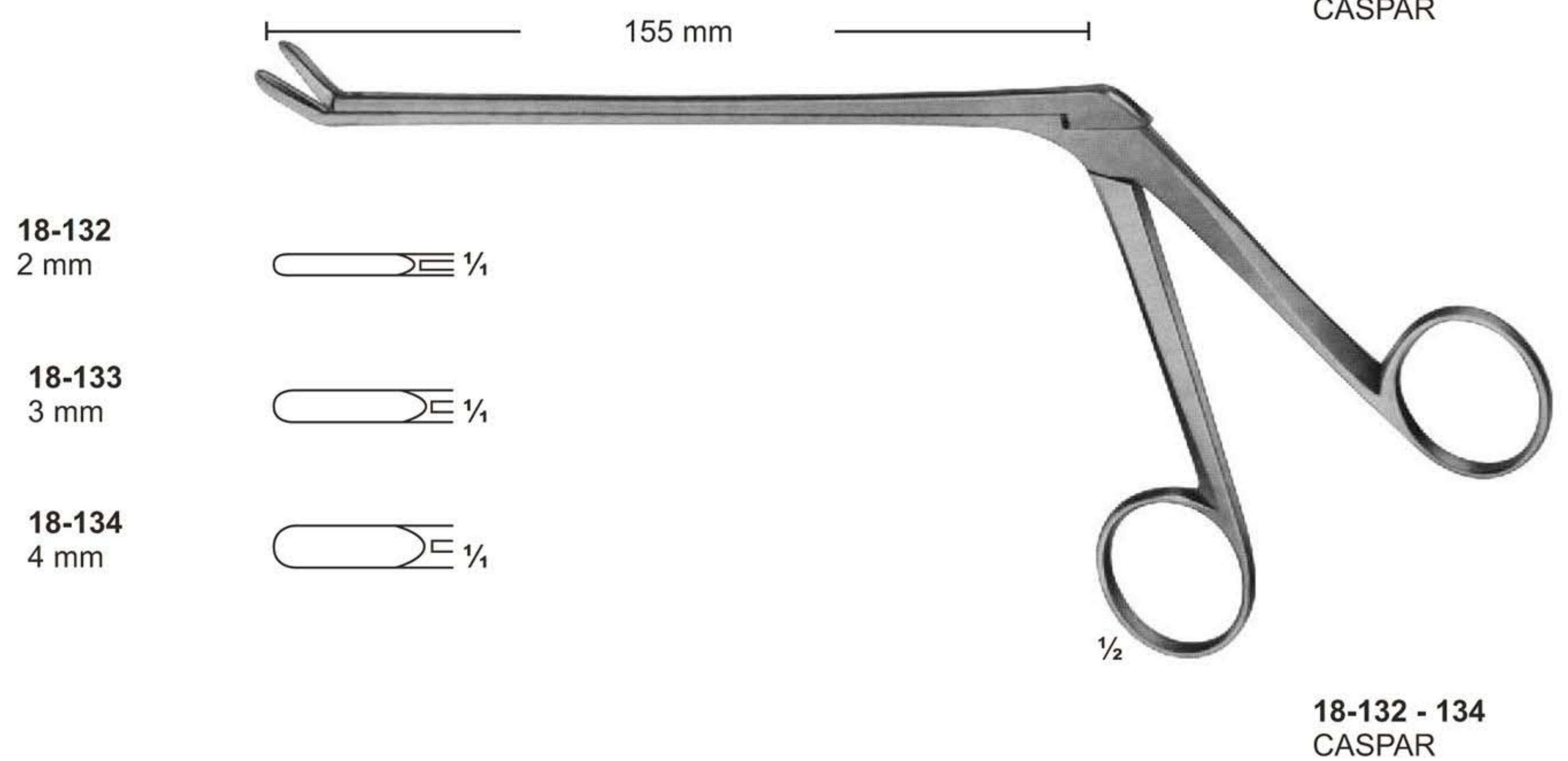
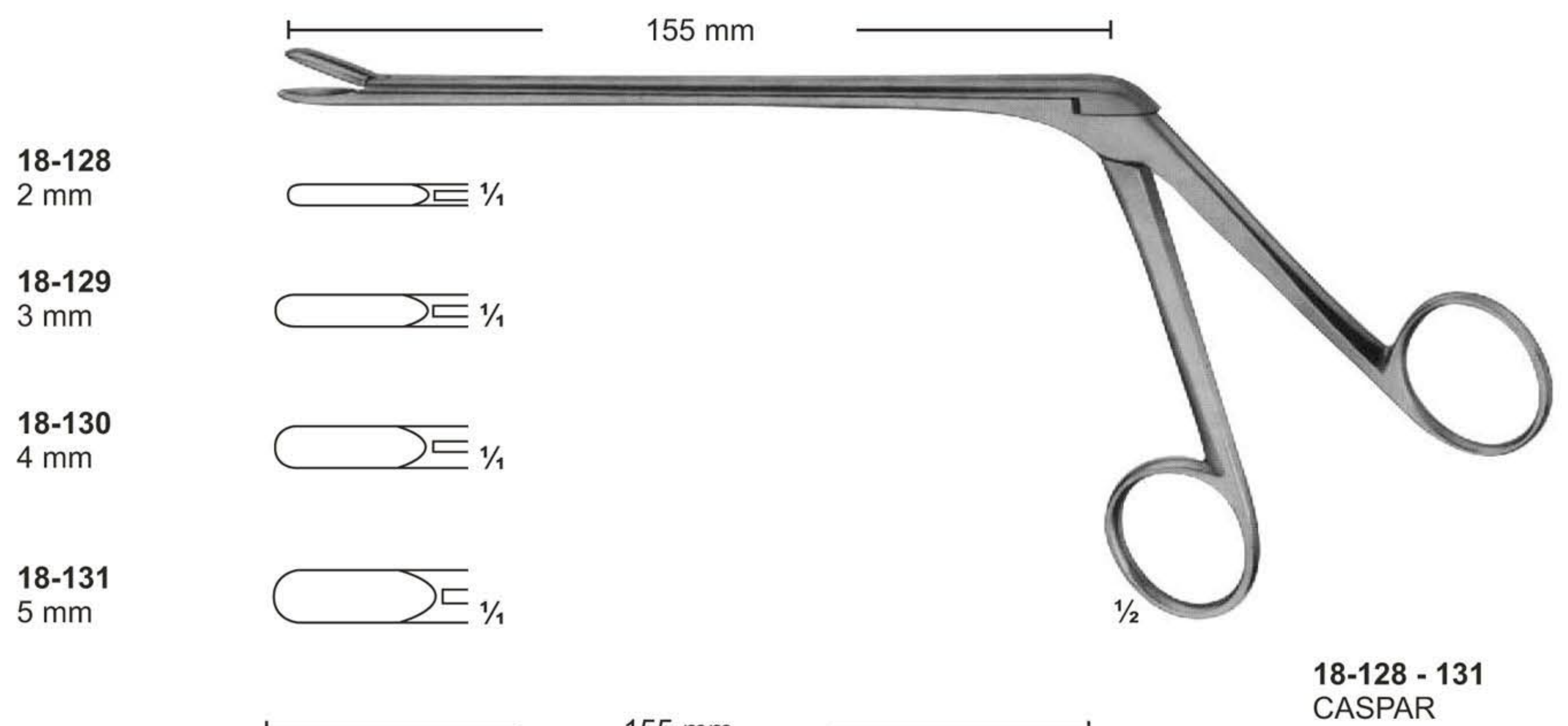
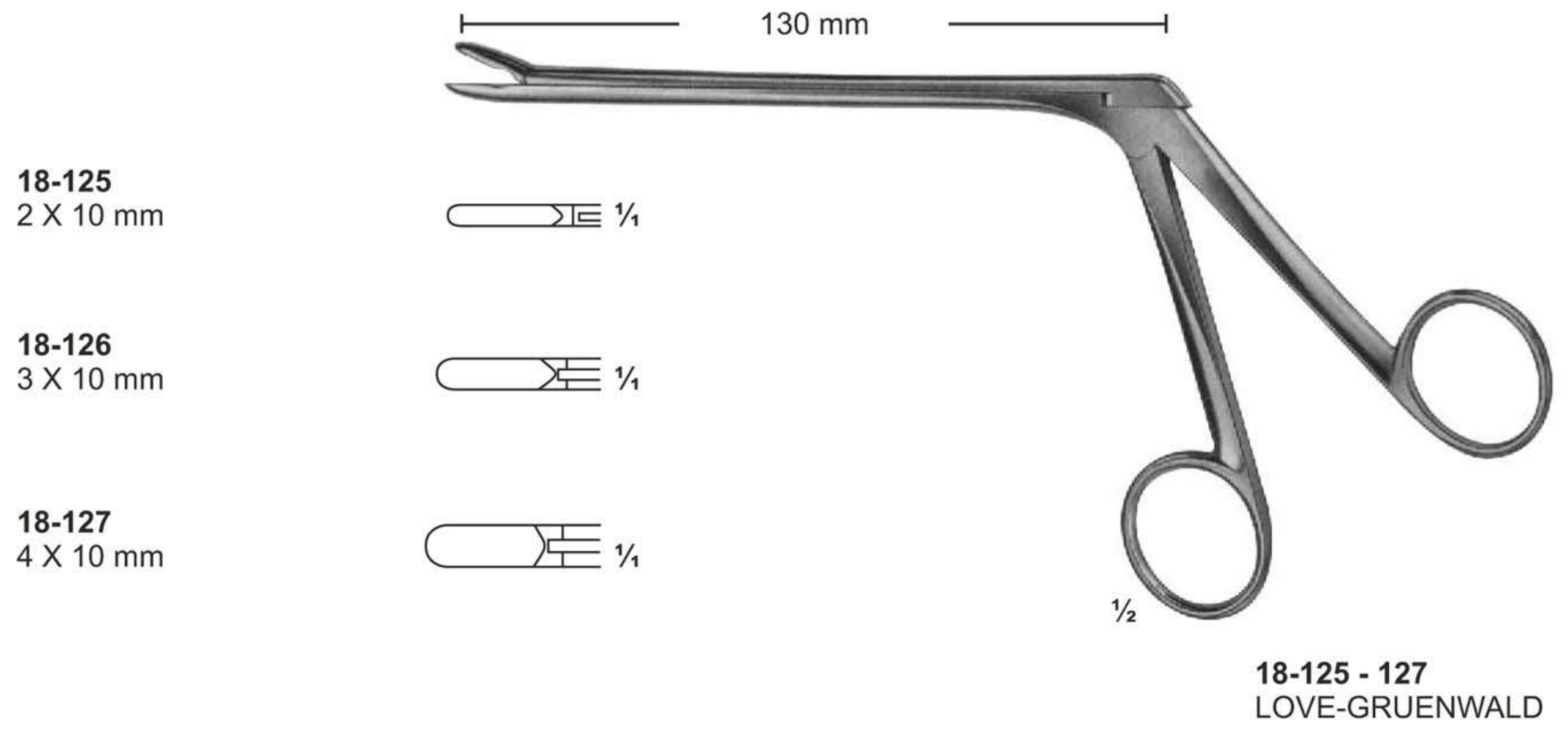



# Rongeurs

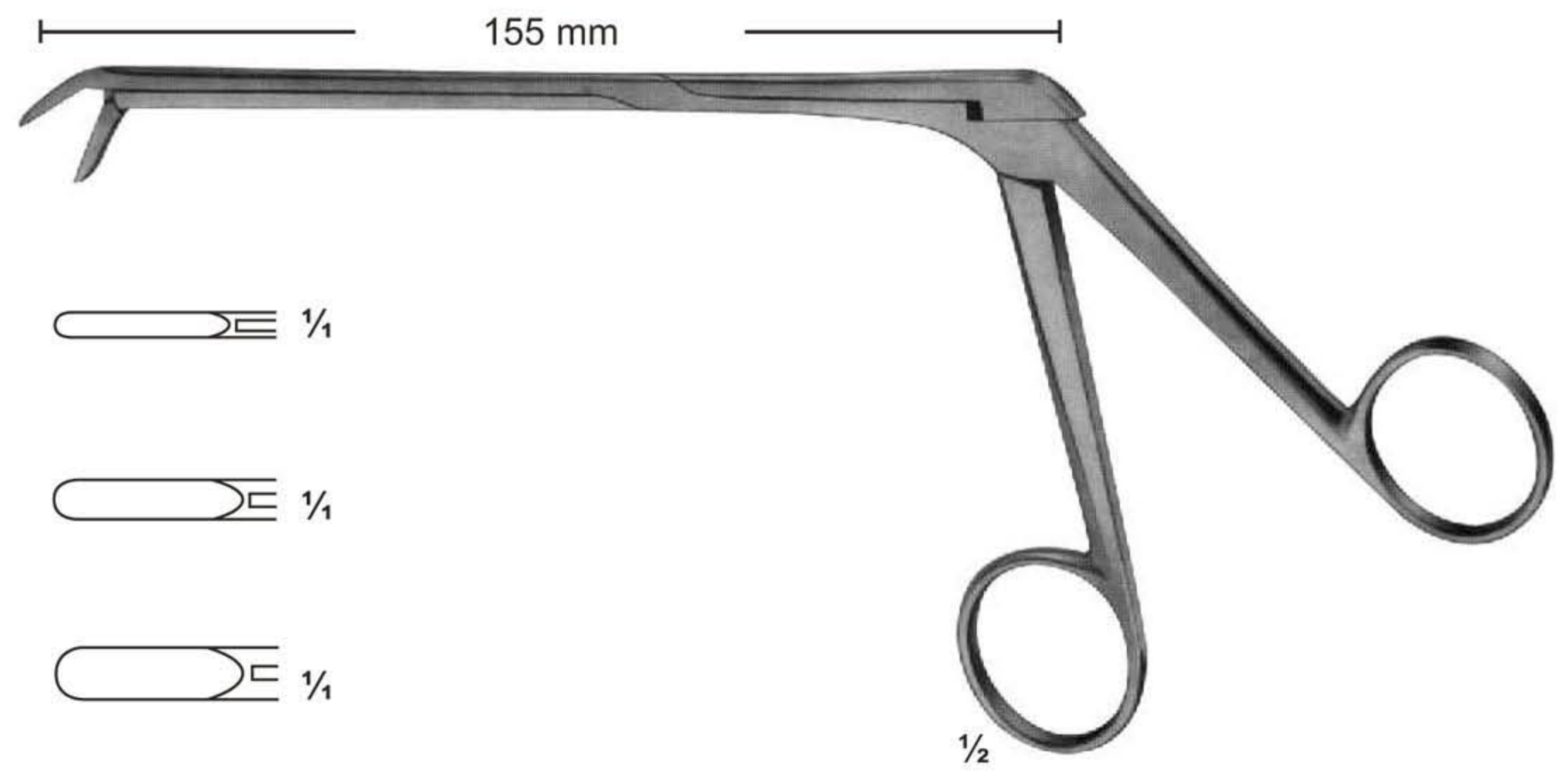

**18-135**  
2 mm



**18-136**  
3 mm

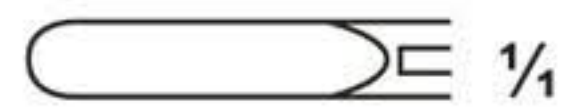

**18-137**  
4 mm



**18-135 - 137**  
CASPAR

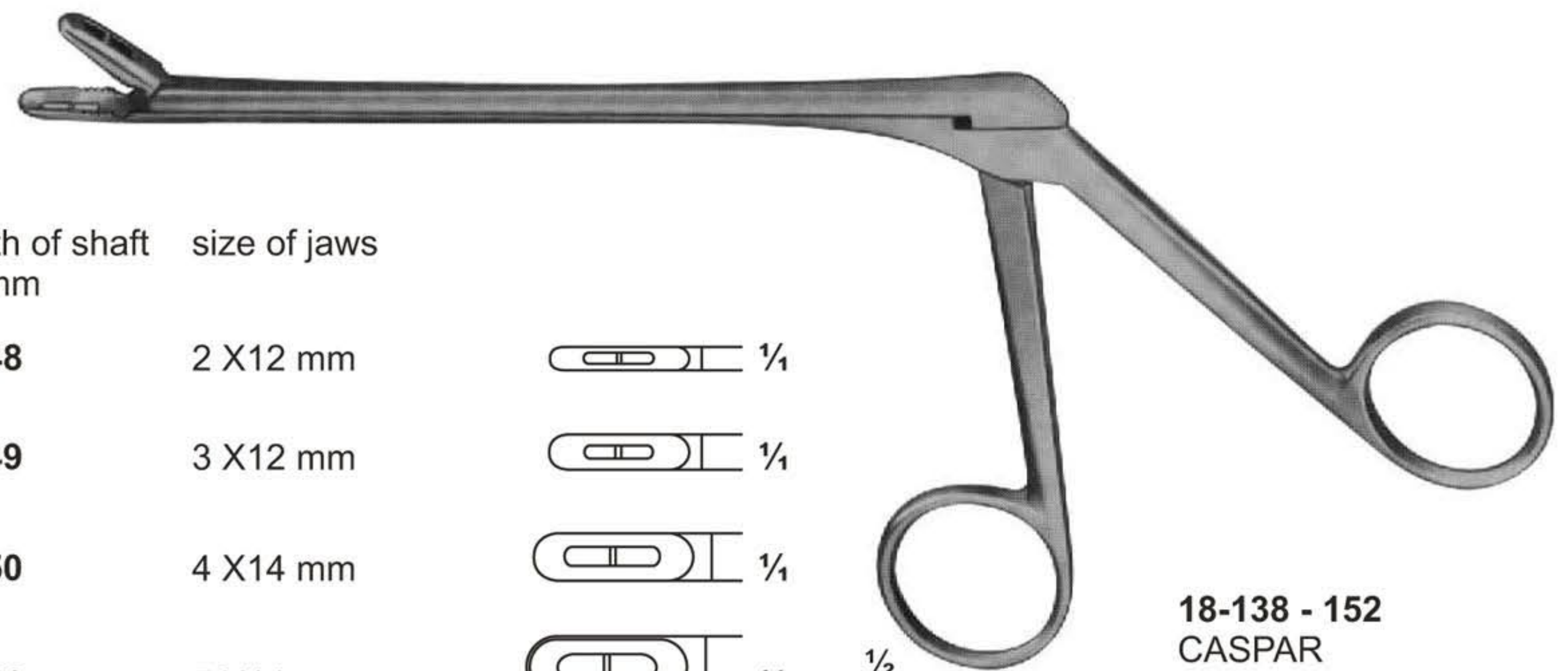

Length of shaft  
140 mm

Length of shaft  
160 mm

Length of shaft  
185 mm

size of jaws

**18-138**

**18-143**

**18-148**

2 X12 mm



**18-139**

**18-144**

**18-149**

3 X12 mm



**18-140**

**18-145**

**18-150**

4 X14 mm



**18-141**

**18-146**

**18-151**

5 X14 mm



**18-142**

**18-147**

**18-152**

6 X16 mm



**18-138 - 152**  
CASPAR

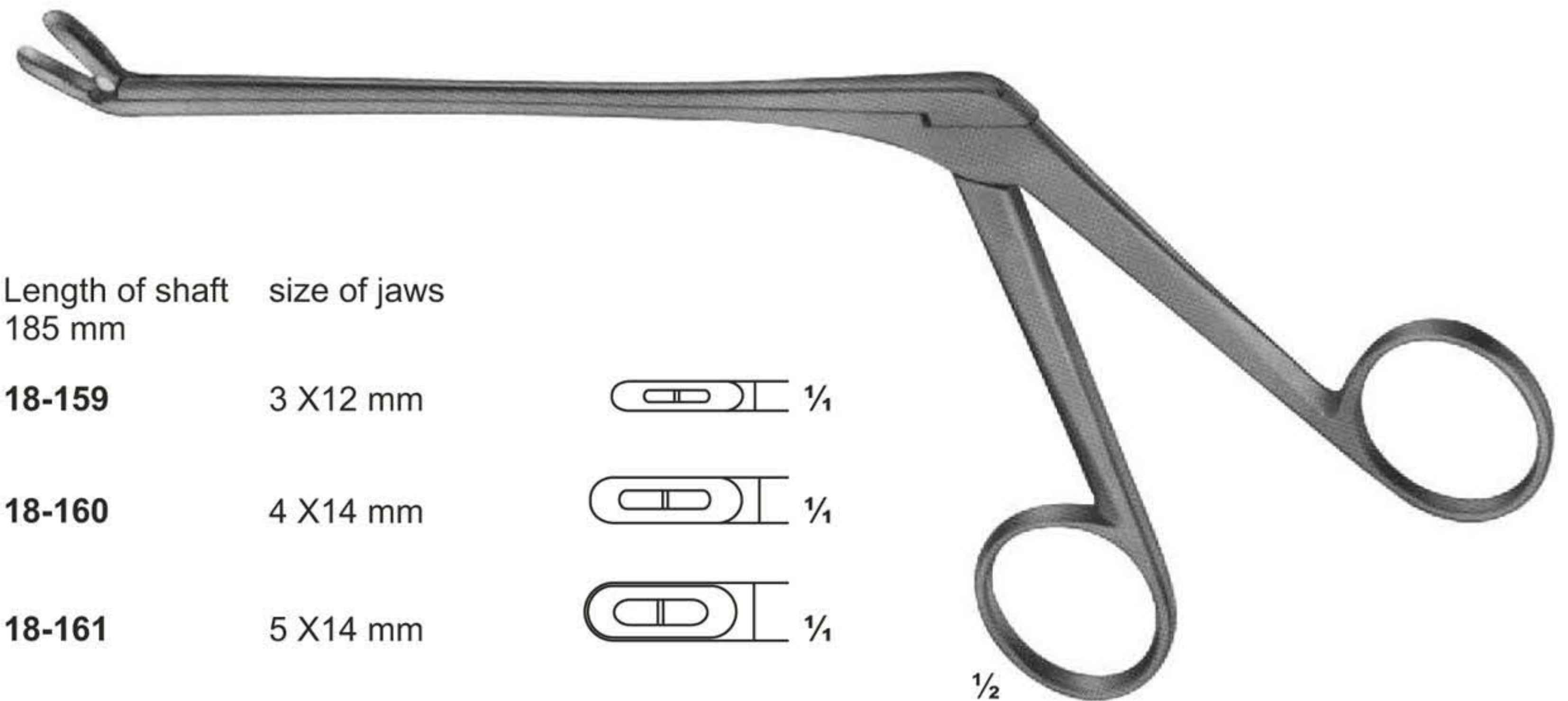

Length of shaft  
140 mm

Length of shaft  
160 mm

Length of shaft  
185 mm

size of jaws

**18-153**

**18-156**

**18-159**

3 X12 mm



**18-154**

**18-157**

**18-160**

4 X14 mm



**18-155**

**18-158**

**18-161**

5 X14 mm



**18-153 - 161**  
CASPAR



Rongeurs

Length of shaft 140 mm	Length of shaft 160 mm	Length of shaft 185 mm	size of jaws
<b>18-162</b>	<b>18-164</b>	<b>185-166</b>	3 X12 mm
<b>18-163</b>	<b>18-165</b>	<b>18-167</b>	4 X14 mm

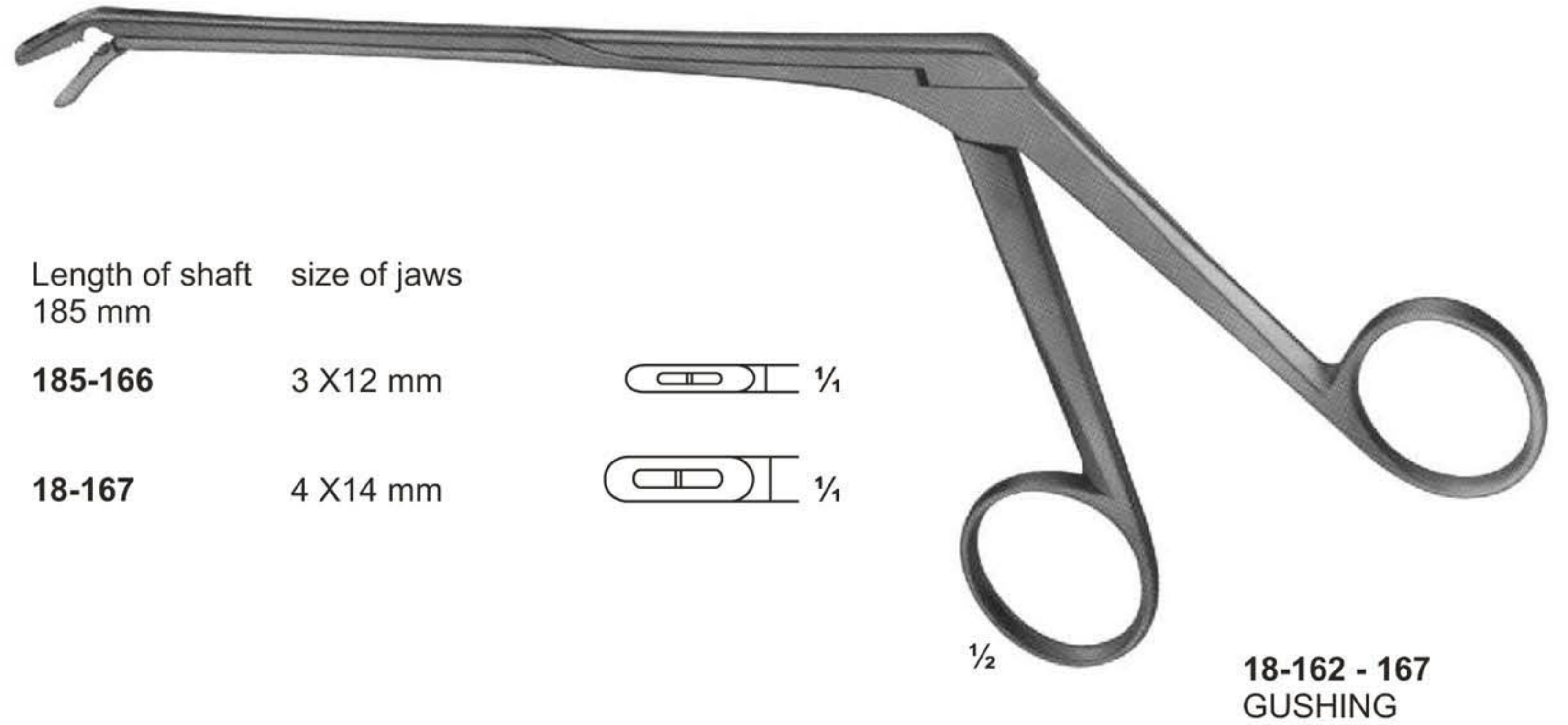

**18-168**  
2 X 10 mm  
GUSHING

**18-169**  
3 X 10 mm  
LOVE-GRUENWALD

**18-170**  
4 X 10 mm  
SPURLING

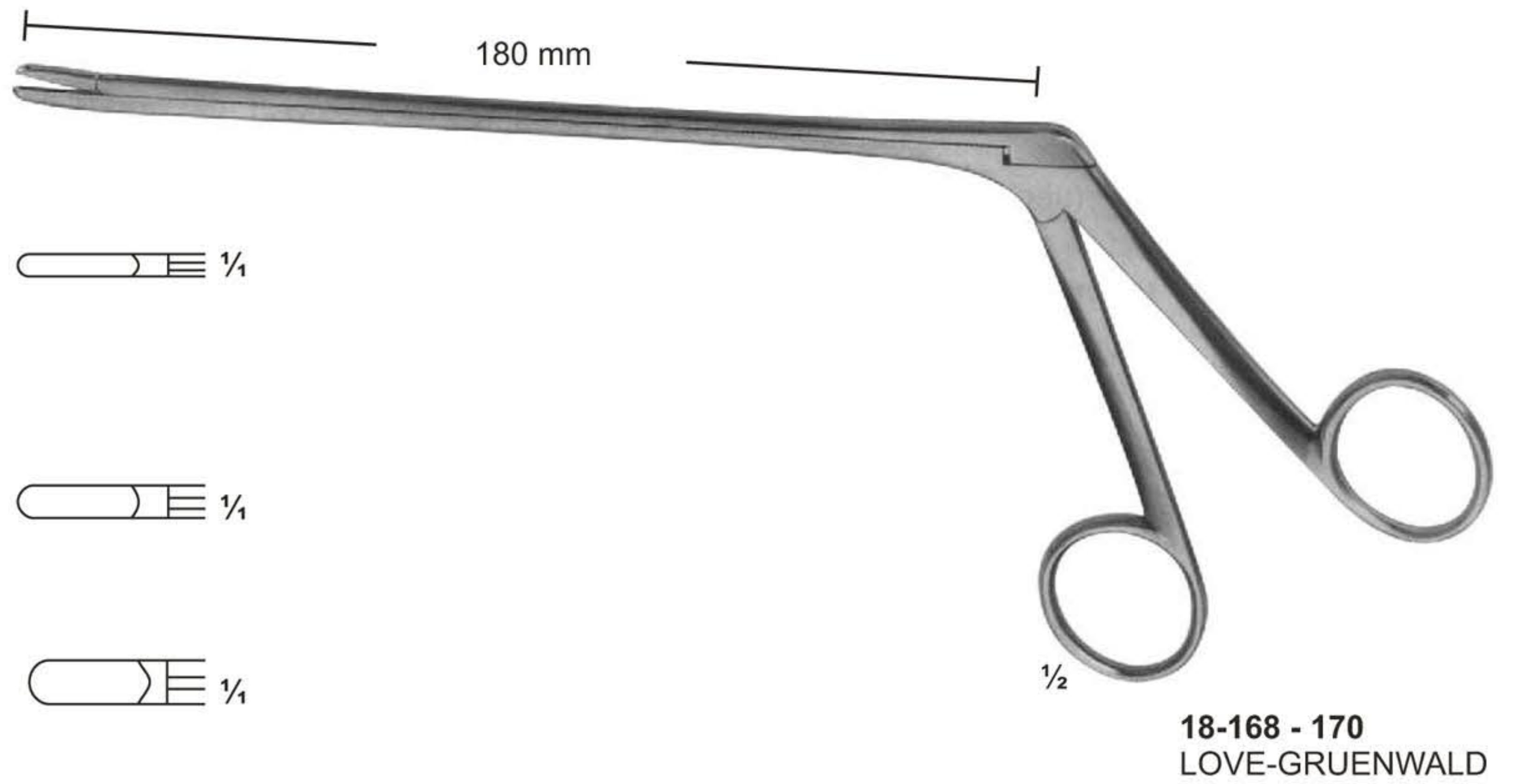

**18-171**  
3 X 10 mm  
LOVE-GRUENWALD

**18-172**  
4 X 10 mm  
SPURLING

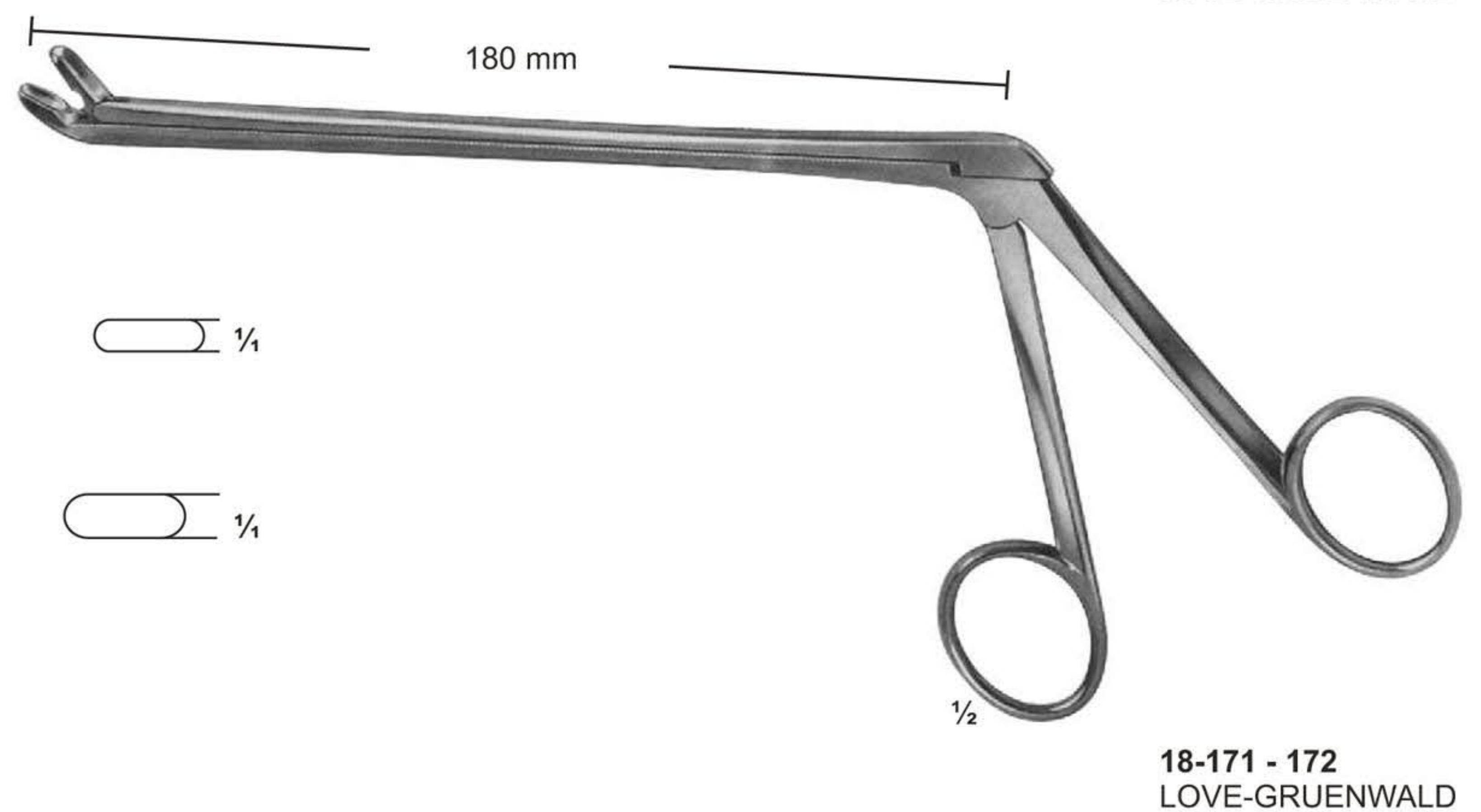



Rongeurs

**18-173**  
3 X 10 mm  
LOVE-GRUENWALD

**18-174**  
4 X 10 mm  
SPURLING

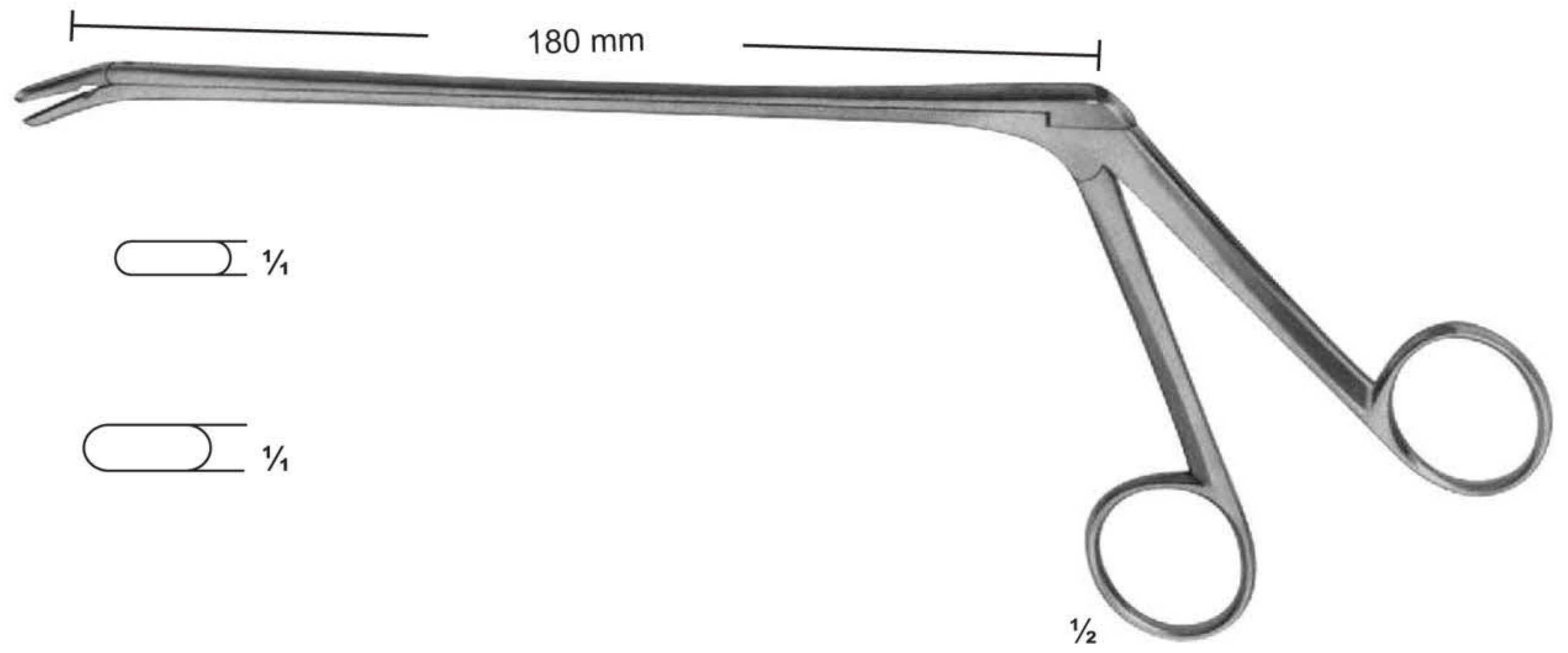

**18-173 - 174**  
LOVE-GRUENWALD

**18-175**  
7 mm

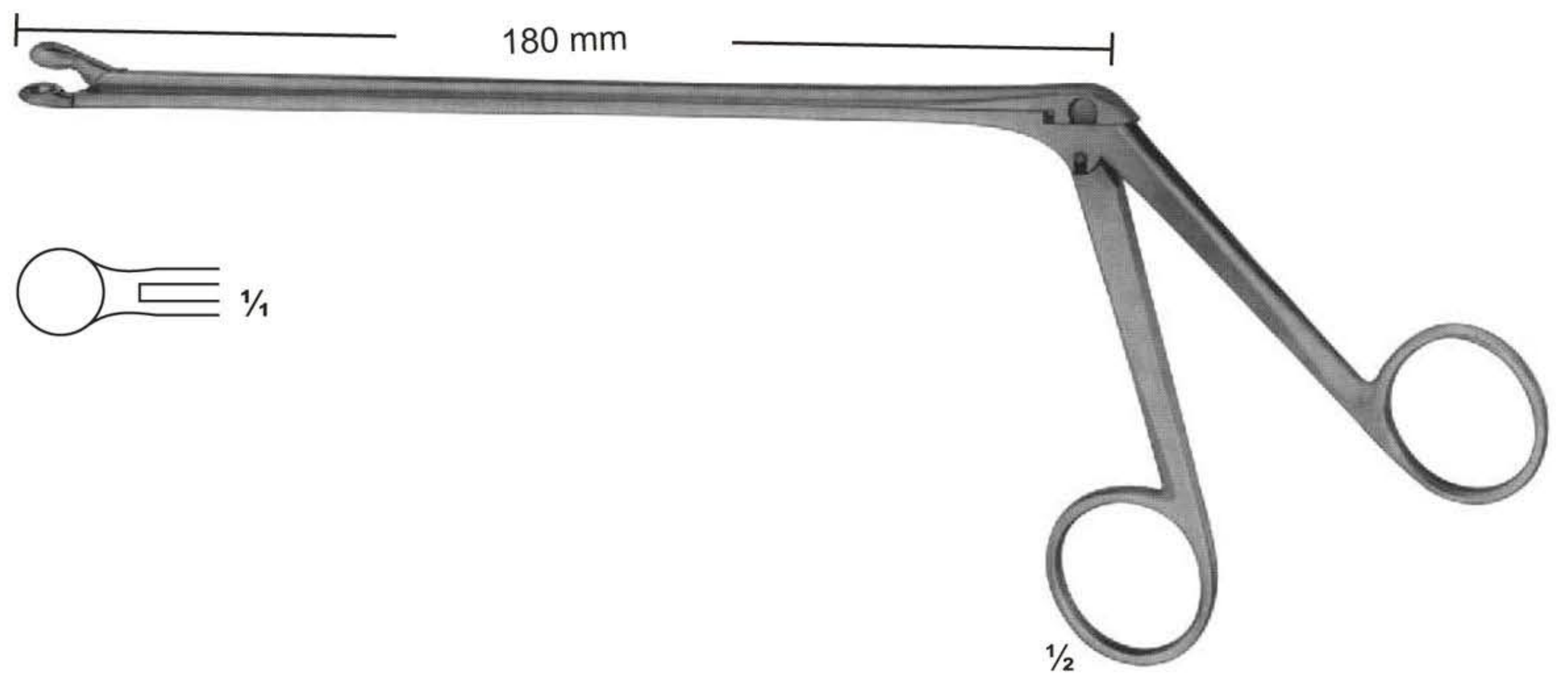

**18-175**  
OLDBERG

**18-176**  
YASARGIL  
2,2 mm

**18-177**  
YASARGIL  
3,5 mm

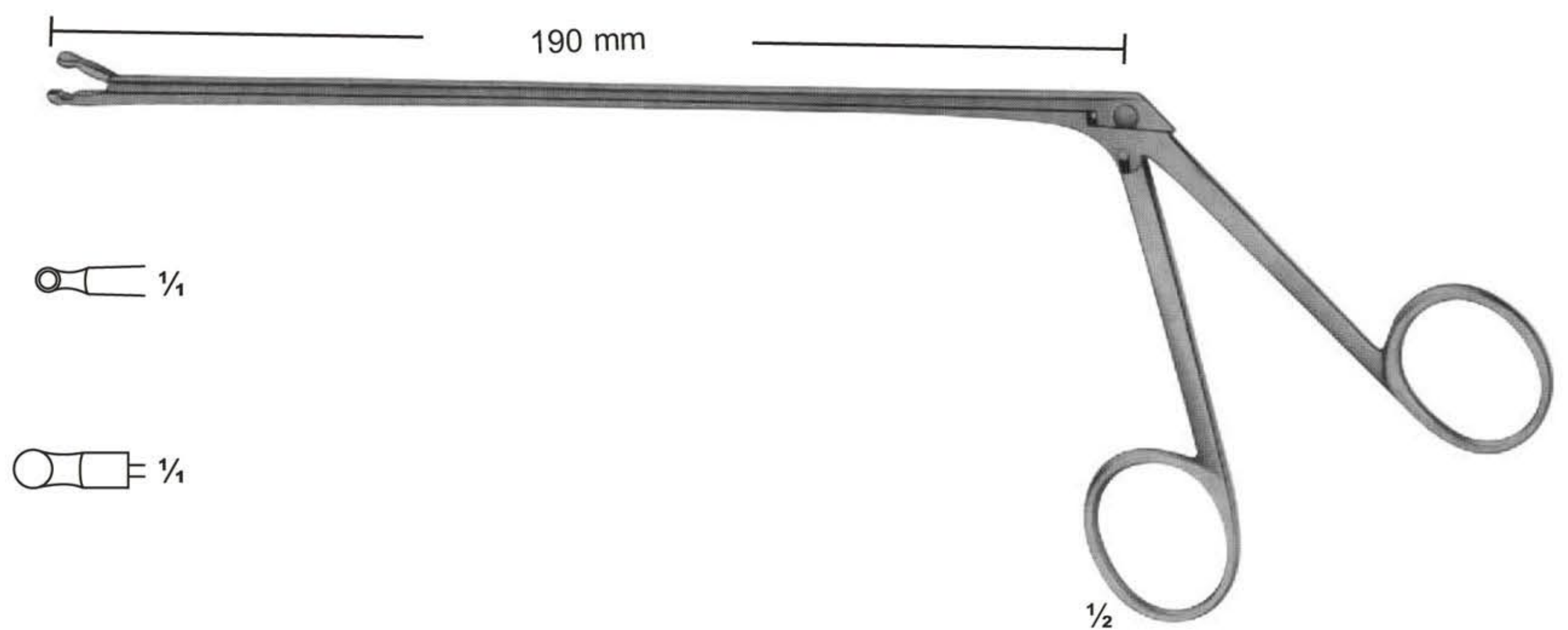

**18-176 - 177**



Rongeurs

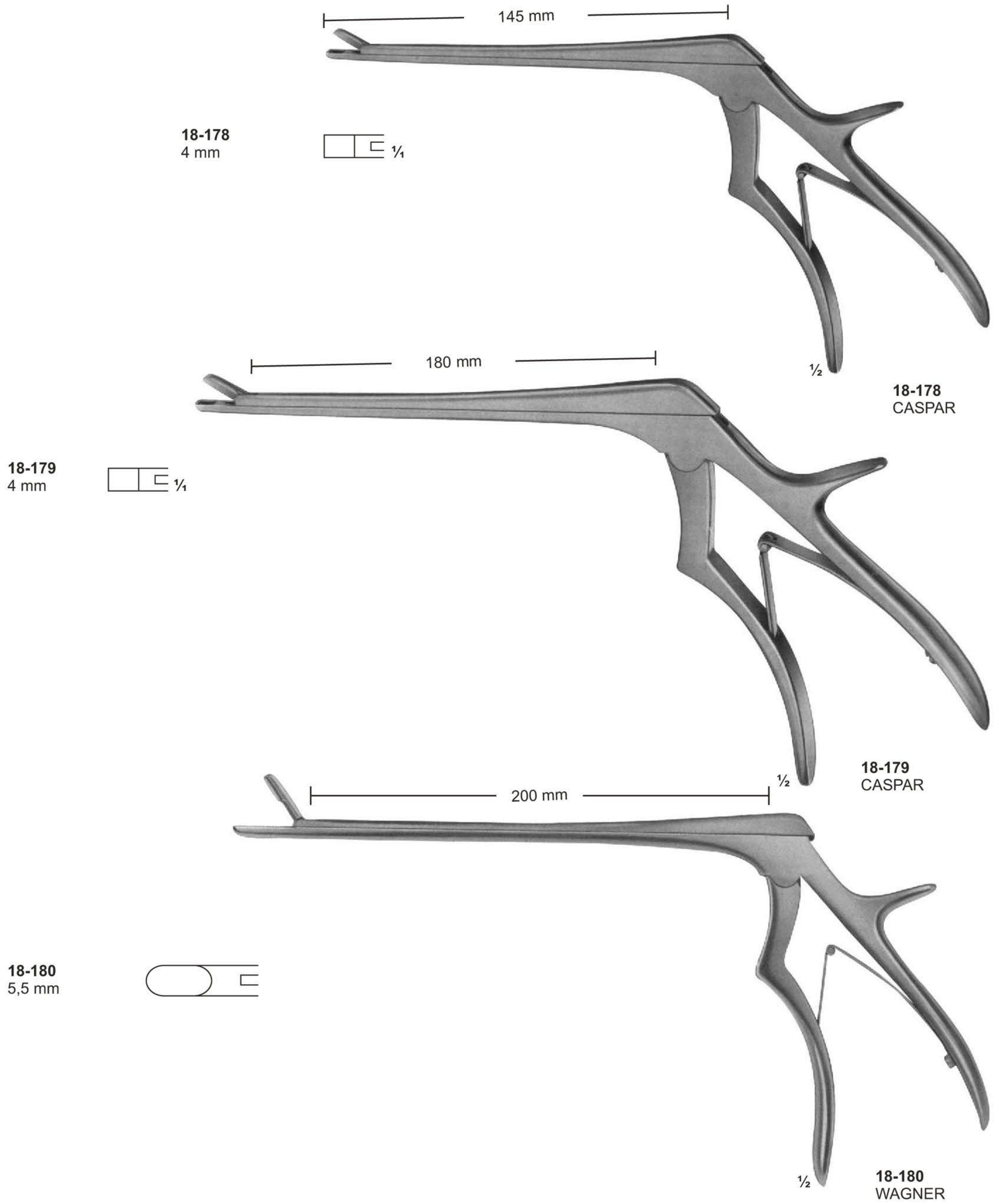



# Amputation

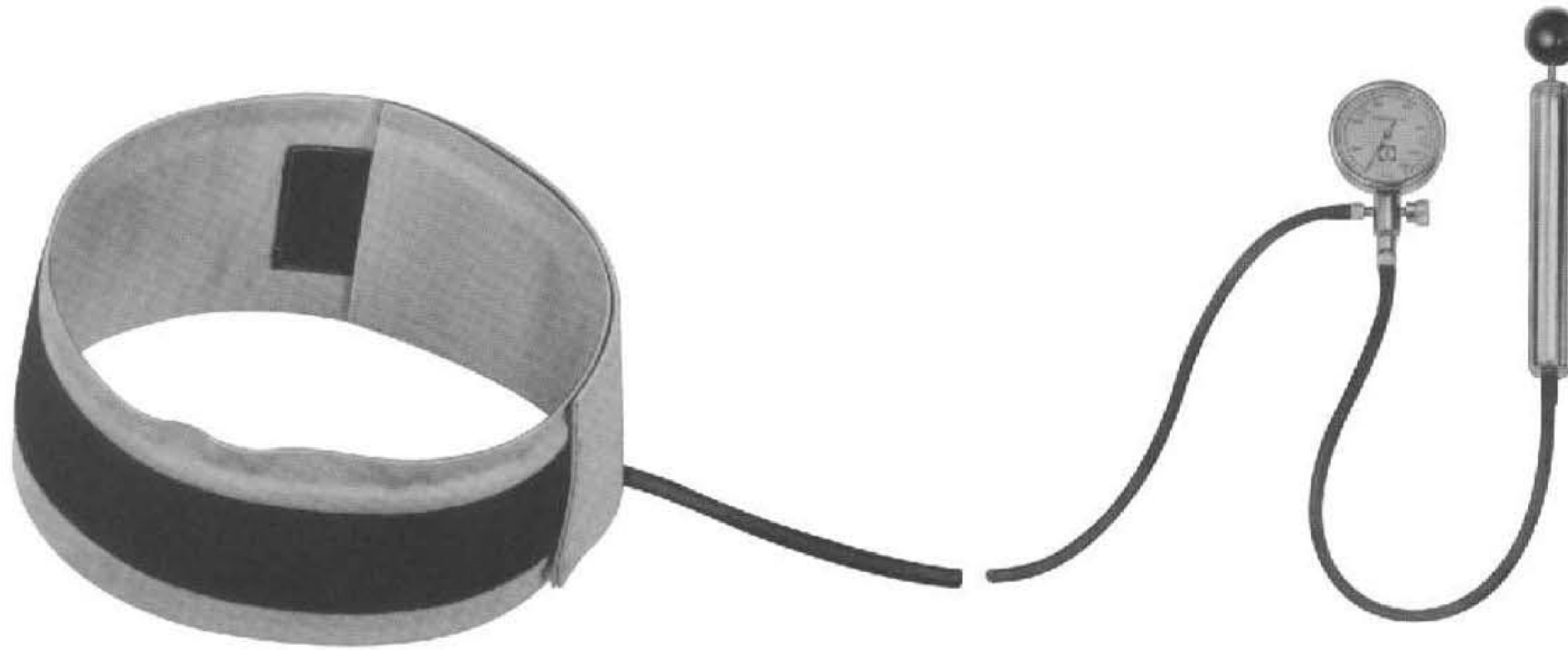

**19-101**  
Comprimeter. Compression apparatus for producing exsanguination in the extremities. Manometer registers up to 600 mm Hg. Complete, consisting of :  
**19-101** 2 Pump with manometer  
**19-102** 3 Cuff for the leg  
**19-103** 14 Cuff for the upper arm

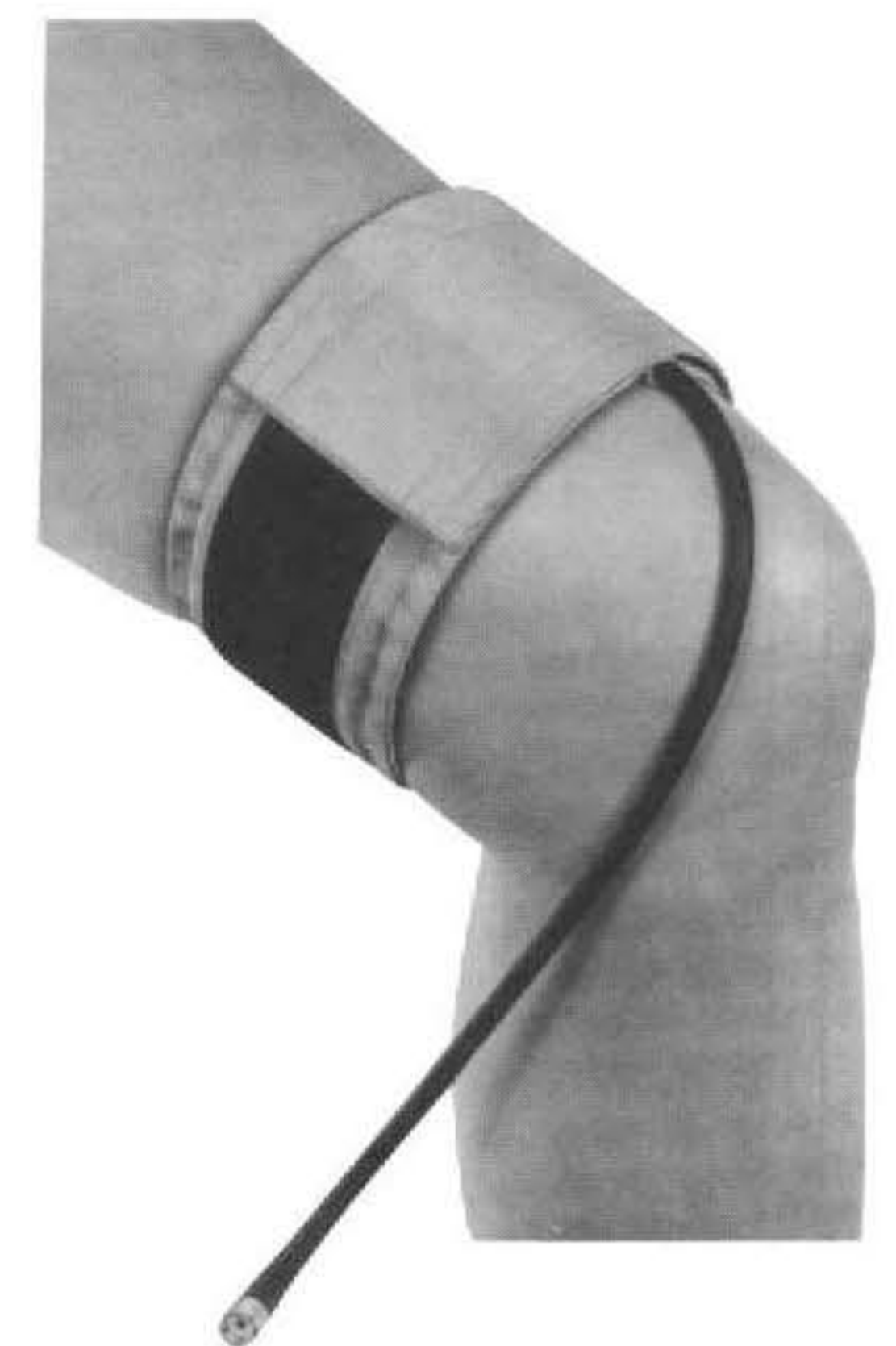

**19-104** 3 Cuff for the leg  
**19-105** 4 Cuff for the lower arm  
**19-106** 5 Cuff for children  
**19-107** 14 Cuff for the upper arm



**19-108**  
ESMARCH  
Staubinde  
Compression bandage  
5 m lang/long  
6 cm breit/wide



**19-109**  
ESMARCH  
Stauschlauch  
Compression tube  
1 m lang/long



## Amputation and Resection Knives



1/2

**19-110**  
Length of blades  
Phalangeal knife  
105 mm



1/2

**19-111**  
Length of blades  
Interosseous knife  
110 mm



1/2

**19-112**  
Length of blades  
Periosteum knife  
with raspatory  
65 mm



1/2

**19-113 - 114**  
**LANGENBECK**  
Length of blades  
Resection knives  
55 mm



**19-113**



**19-114**



## Amputation Retractors

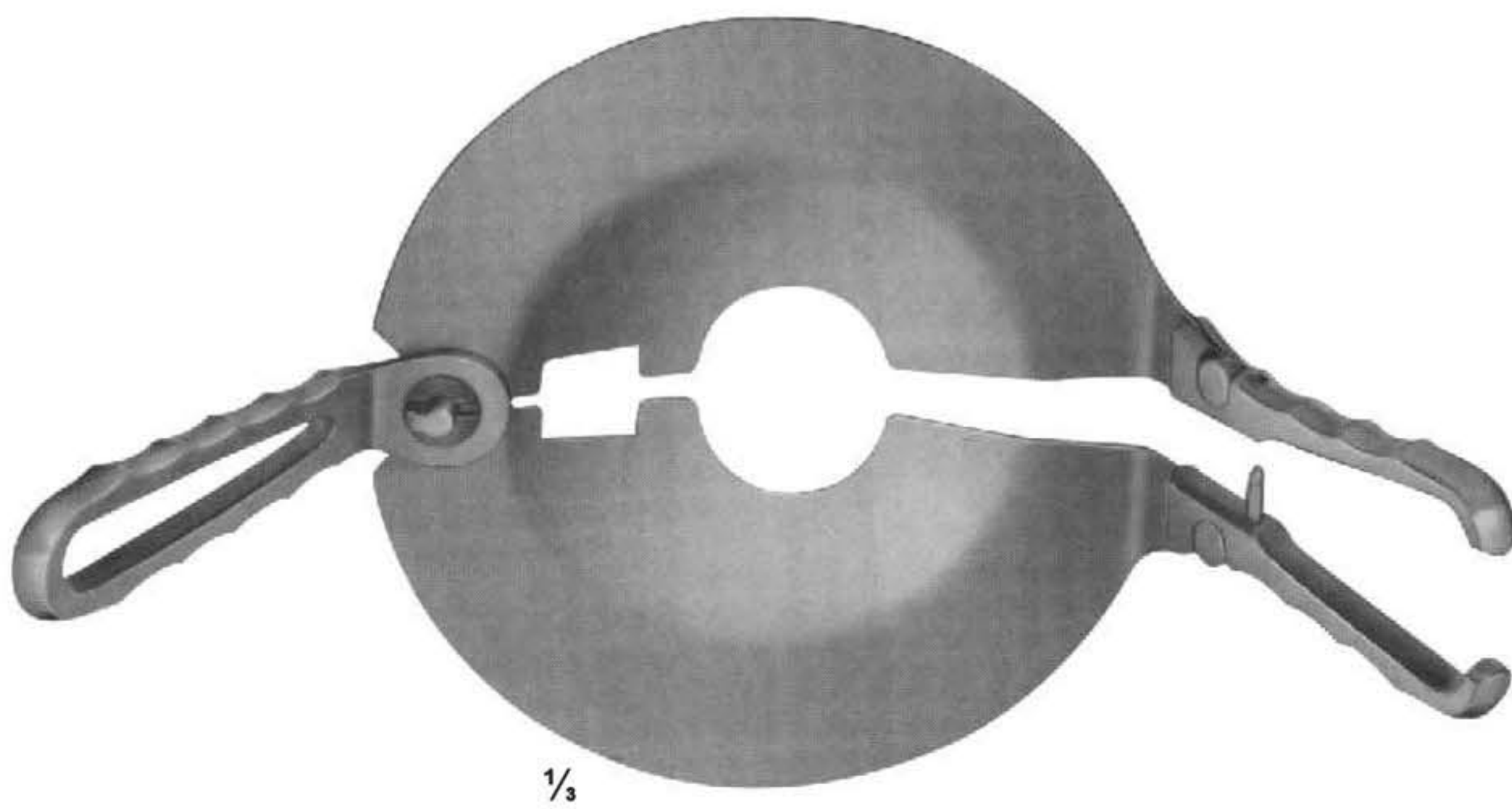

1/3

**19-115**  
PERCY  
removeable handles

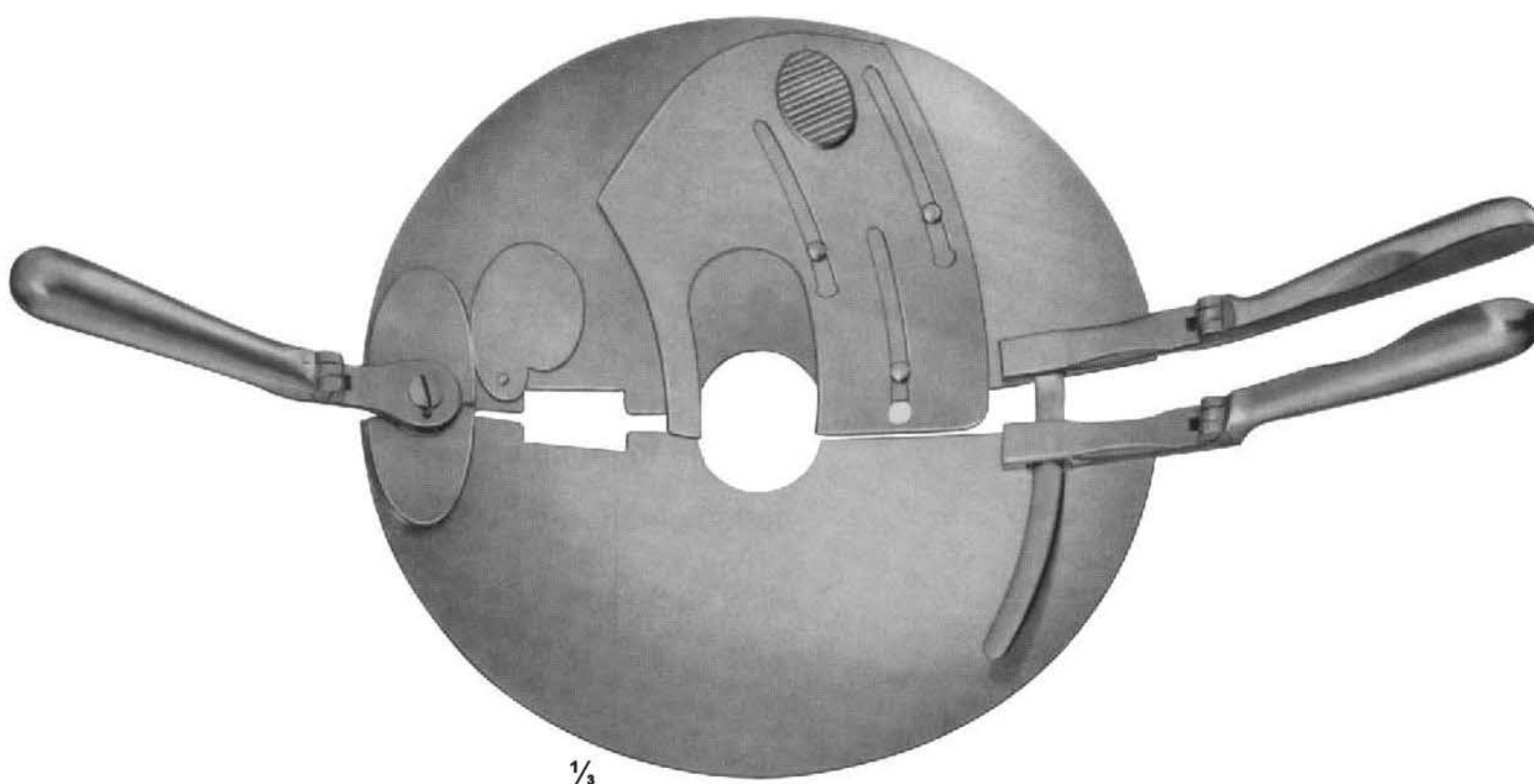

1/3

**19-116**  
PERCY  
reversible handles



## Amputation Saws



1/3  
**19-117**  
 CHARRIÈR  
 Length of blade  
 215 mm  
 complete with one saw  
 blade each  
 350 mm  
 Spare saw blades, carbon steel  
**19-118** 12 mm  
**19-119** 20 mm

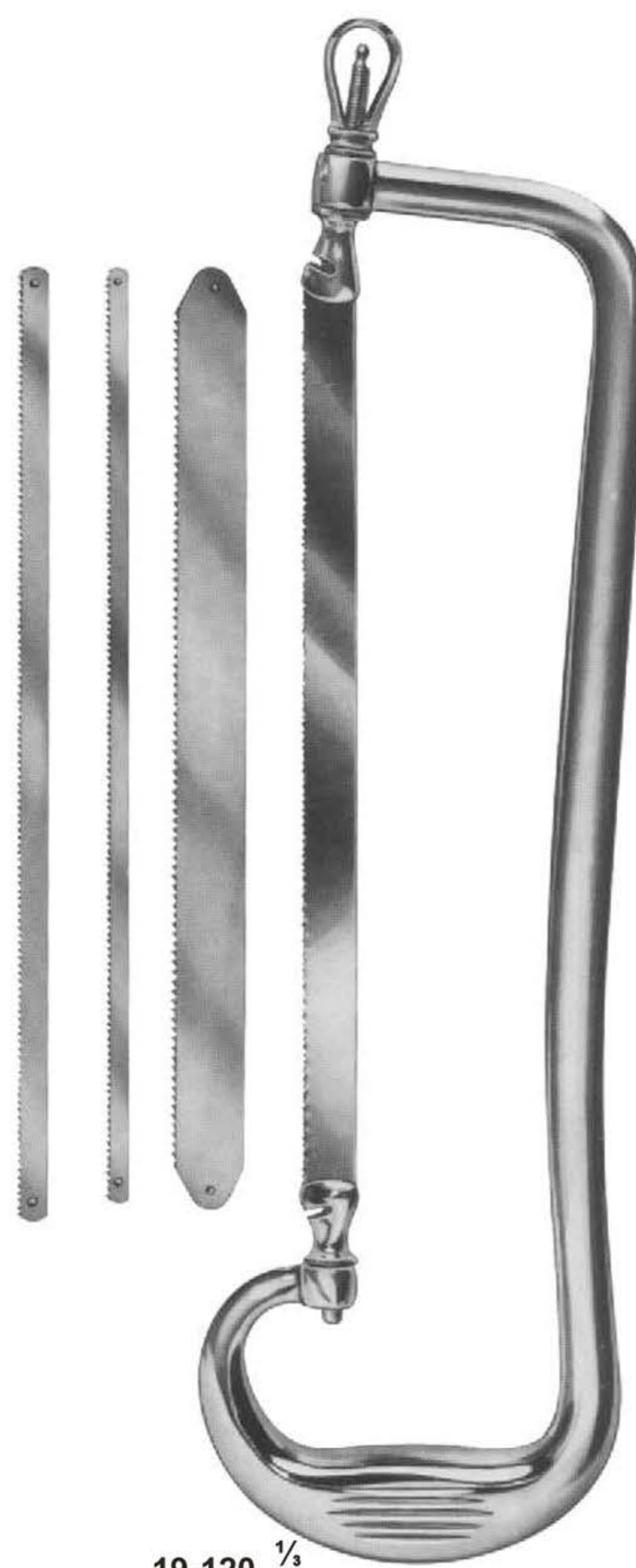

1/3  
**19-120**  
 RUST  
 Length of blade  
 235 mm  
 complete with one saw  
 blade each  
 390 mm  
**19-121** Bow only  
 Spare saw blades, carbon steel  
**19-122** 6 mm  
**19-123** 8 mm  
**19-124** 12 mm  
**19-125** 20 mm



## Amputation Saws

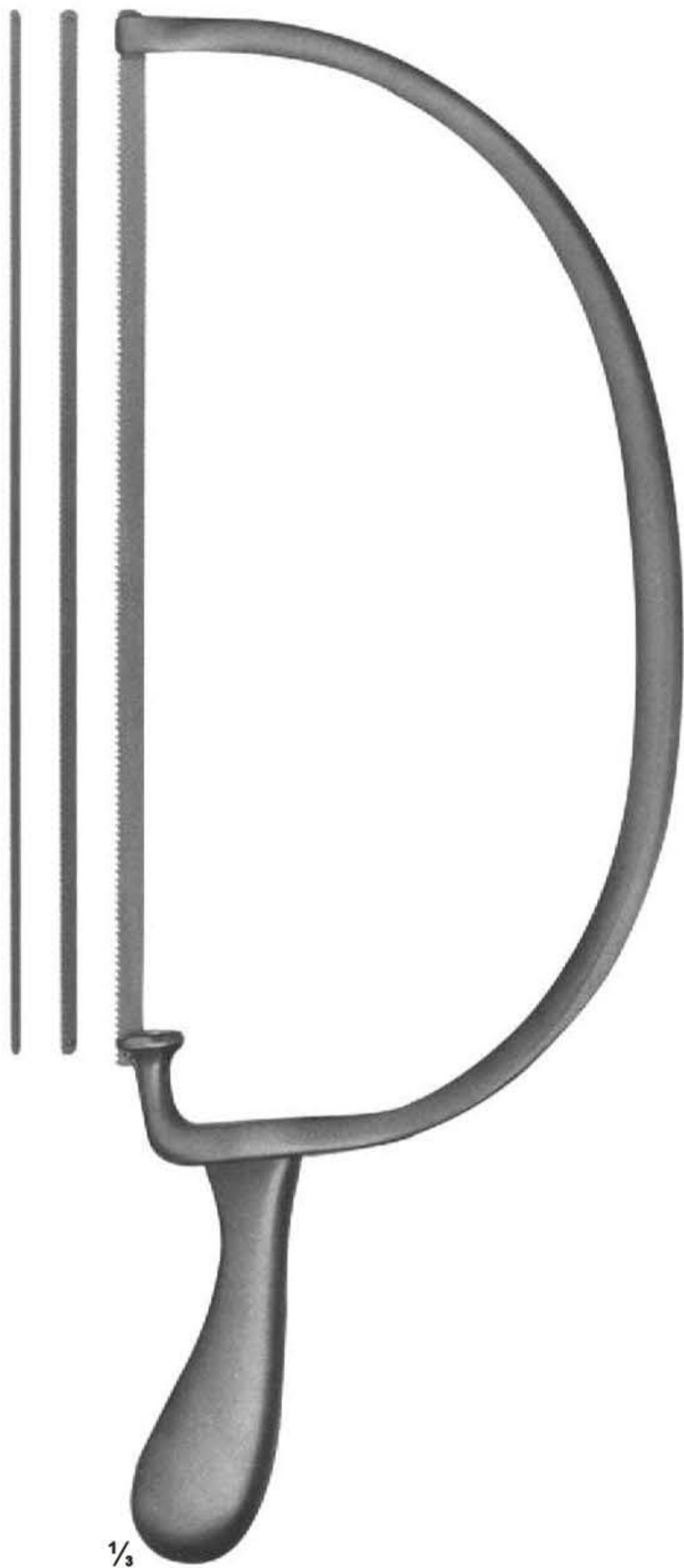

1/3

**19-126**  
BIER  
Length of blade  
270 mm  
complete with one saw  
blade each  
420 mm  
Spare saw blades, carbon steel  
**19-127** 4 mm  
**19-128** 6 mm  
**19-129** 8 mm



1/3

**19-130**  
CHARRIERE  
Length of blade  
180 mm  
Spare saw blades,  
carbon steel  
270 mm

**19-131**  
CHARRIERE  
Length of blade  
240 mm  
Spare saw blades,  
carbon steel  
340 mm



1/3

**19-132**  
SATTERLEE  
Length of blade  
200 mm  
Spare saw blades,  
carbon steel  
290 mm



1/3

**19-133**  
LANGENBACK  
Length of blade  
115 mm  
Metacarpal saw  
235 mm



## Wire Saws and Conductor



**OLIVECRONA**  
**19-134** 300 mm  
**19-135** 400 mm  
**19-136** 500 mm  
**19-137** 700 mm

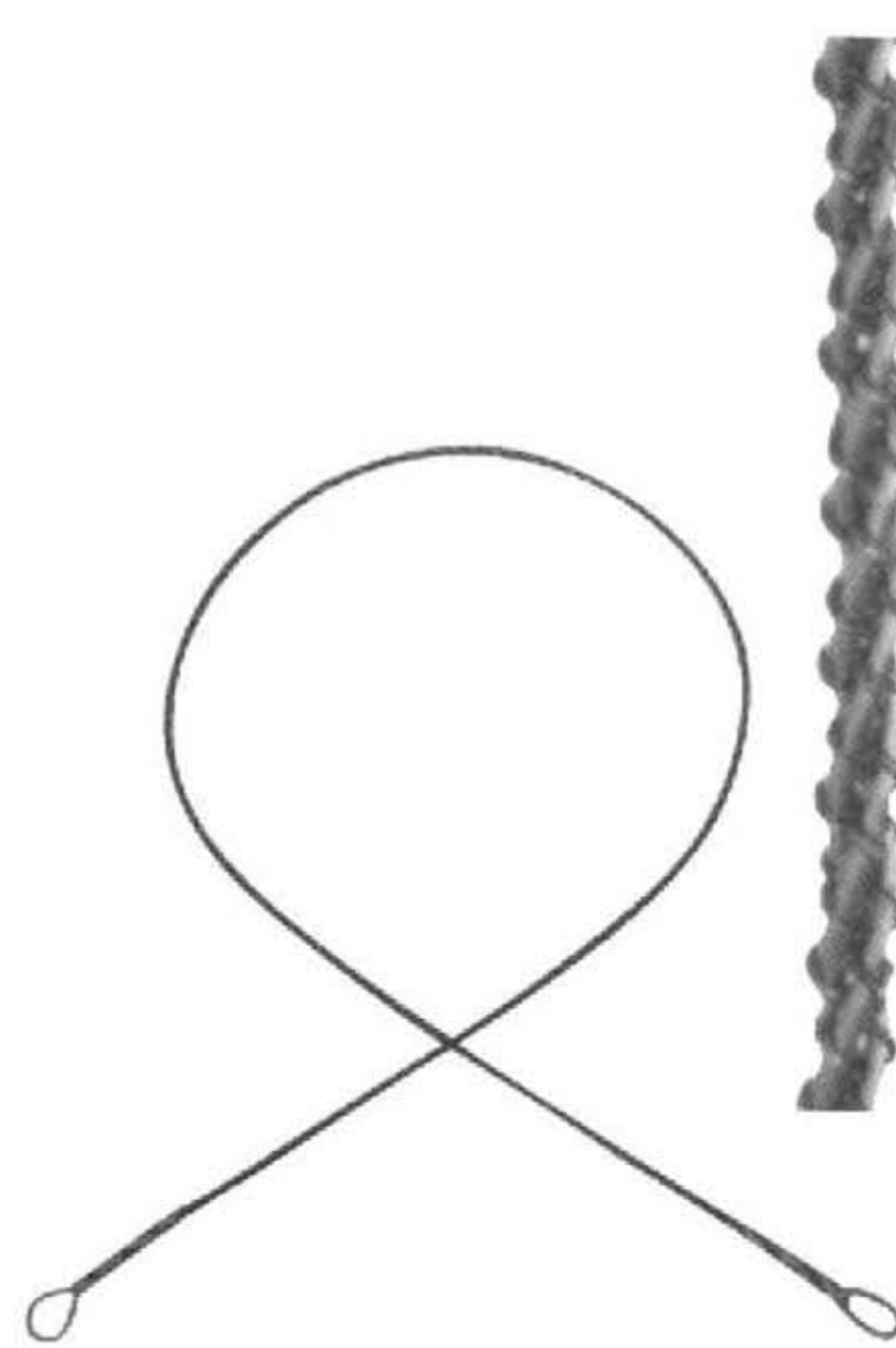

**GIGLI**  
**19-138** 300 mm  
**19-139** 400 mm  
**19-140** 500 mm  
 fine, 6 wires twisted  
**19-141**  
 coares, 4 wires twisted



$\frac{1}{4}$   
**19-142**  
**GIGLI**  
 Handle



$\frac{1}{2}$   
**19-143**  
**LEBSCHE**  
 Conductor for  
 wire saws, malleable  
 250 mm



**Elevators and Bone Levers**

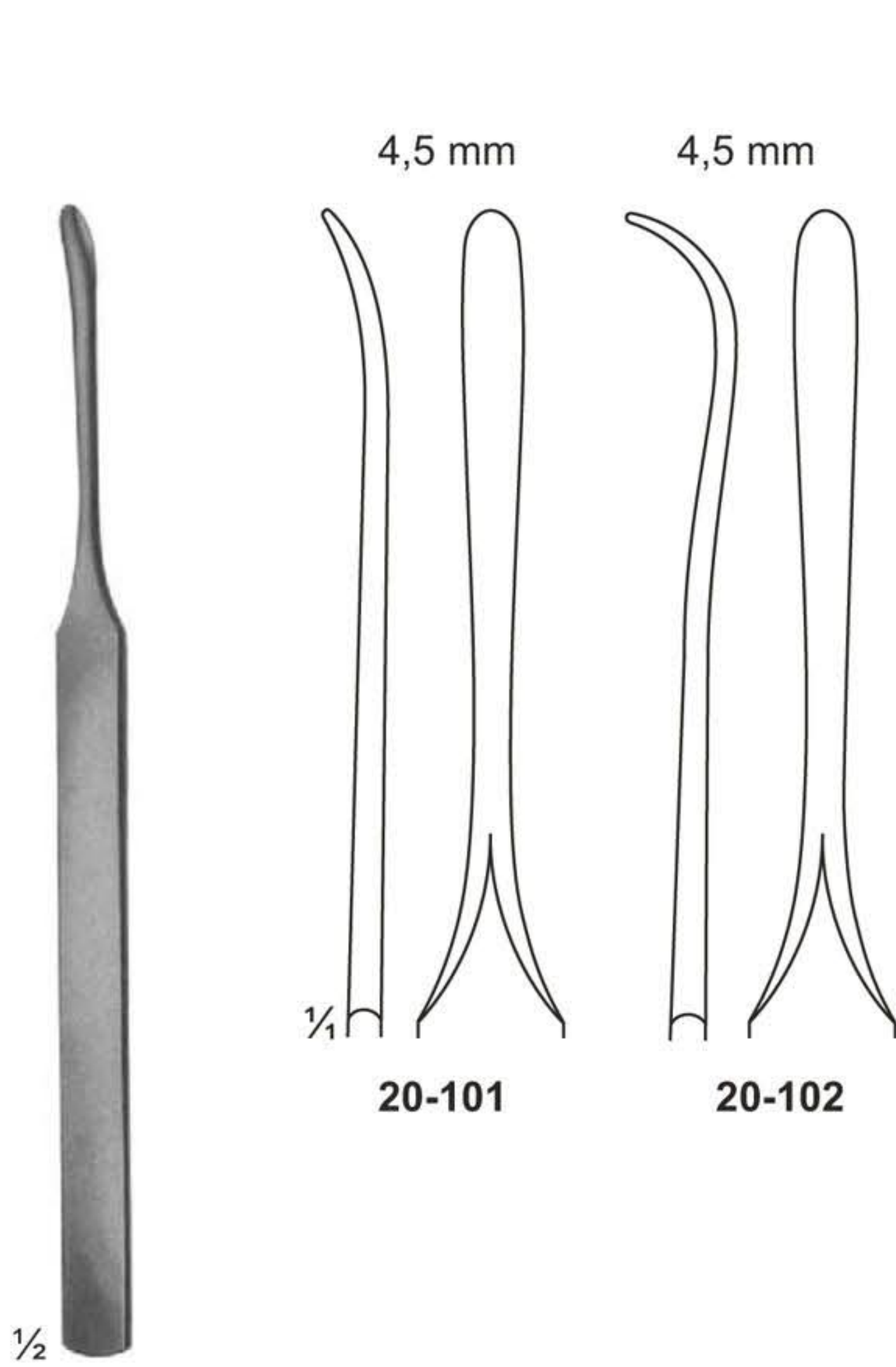

**20-101 - 102**  
KONIG  
155 mm

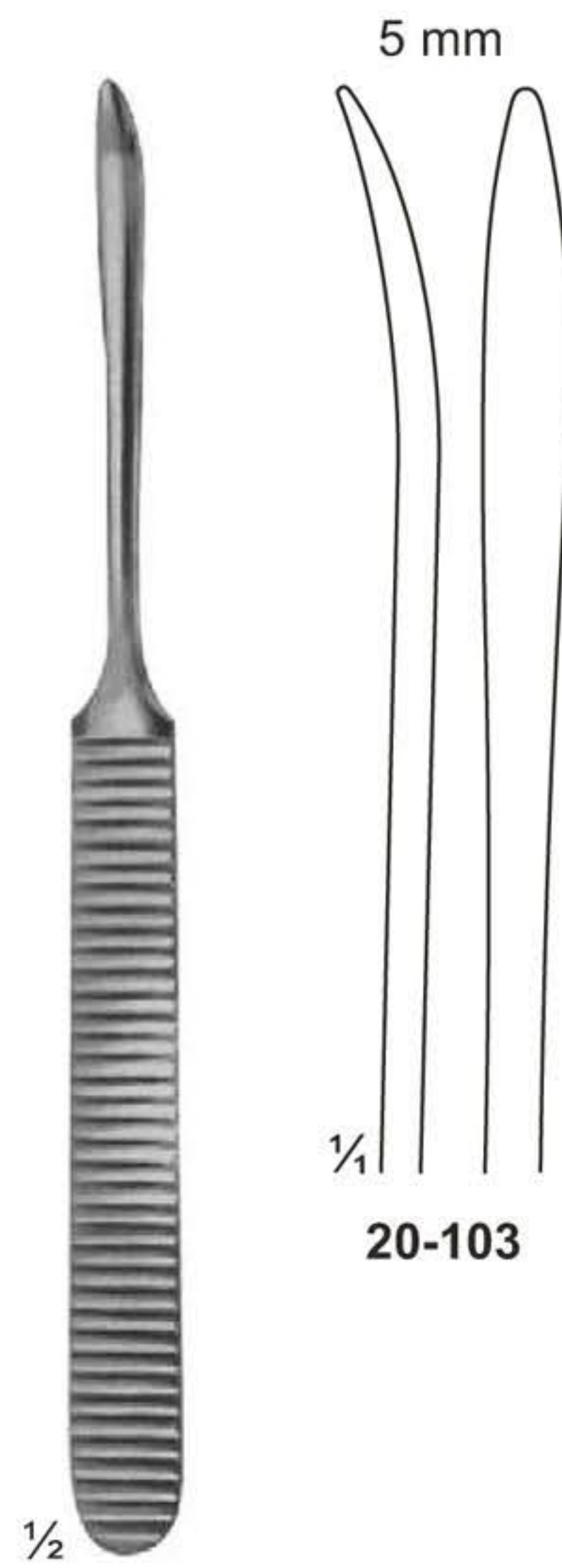

**20-103**  
WILLIGER  
165 mm

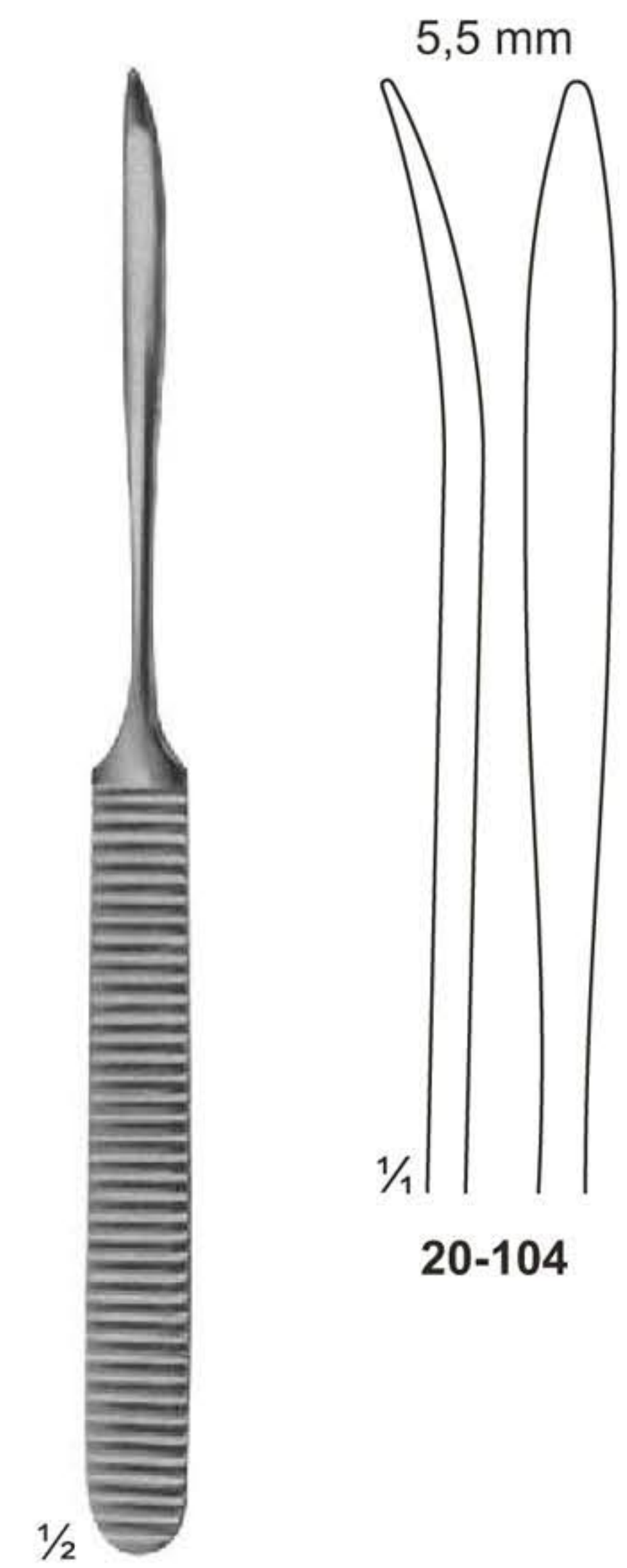

**20-104**  
WILLIGER  
170 mm

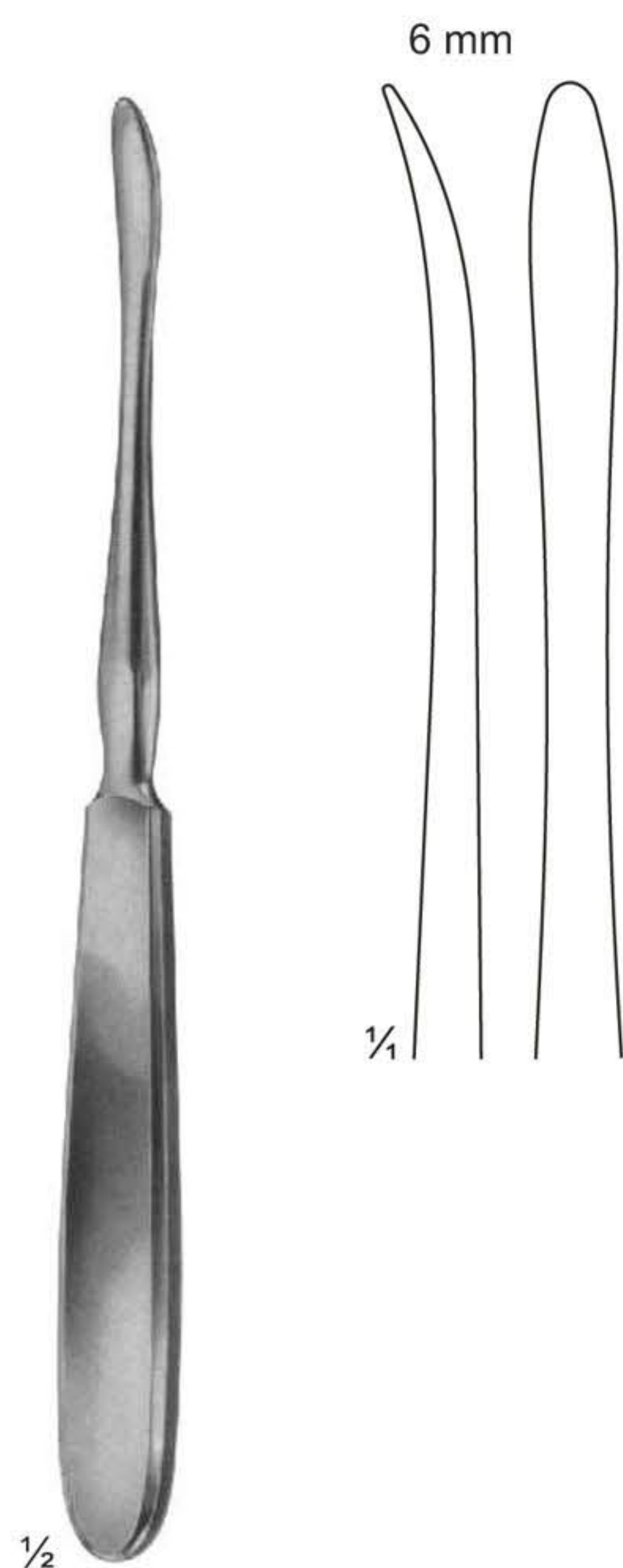

**20-105**  
QUERVAIN  
195 mm

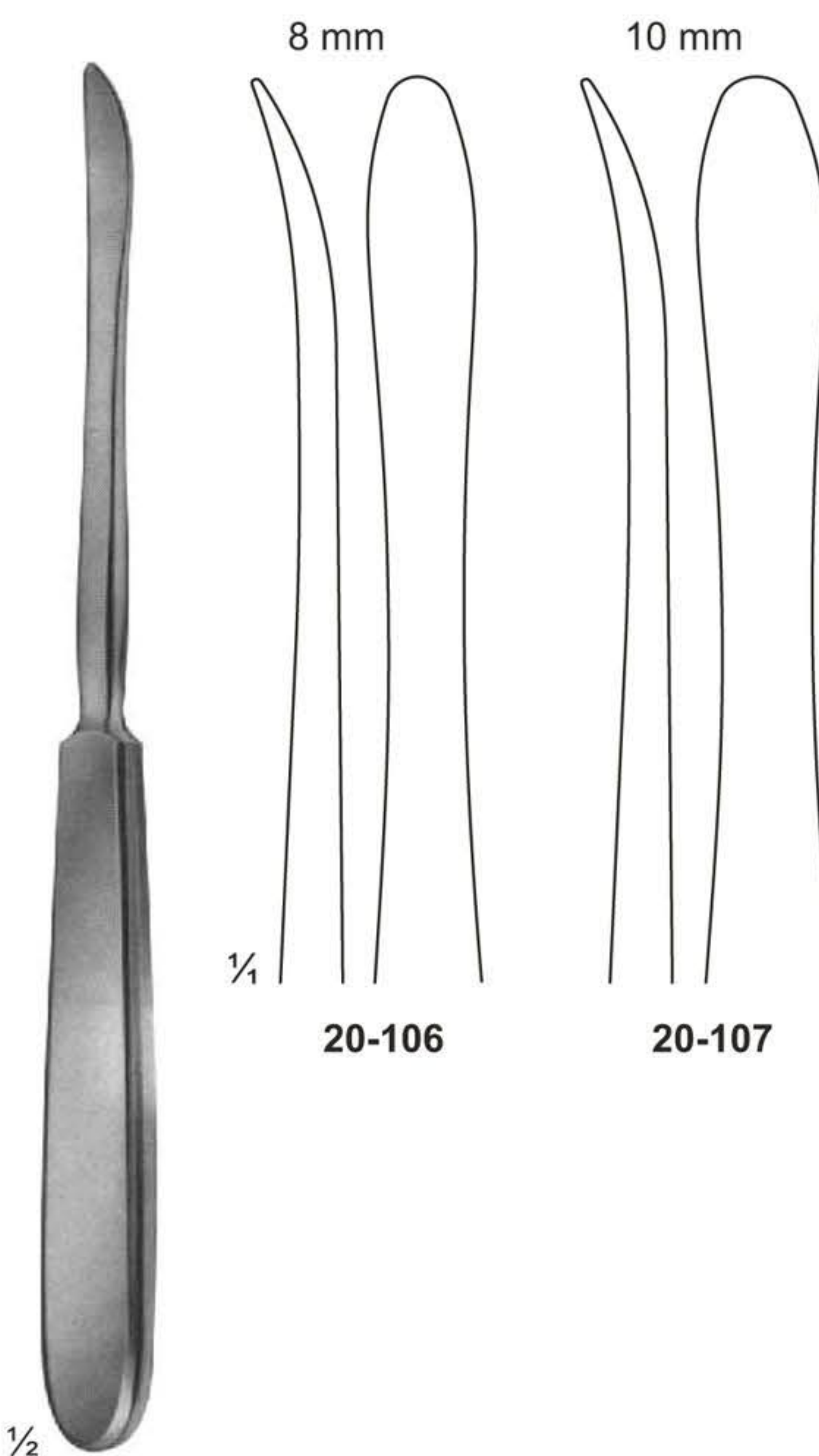

**120-106 - 107**  
LANGENBACK  
195 mm

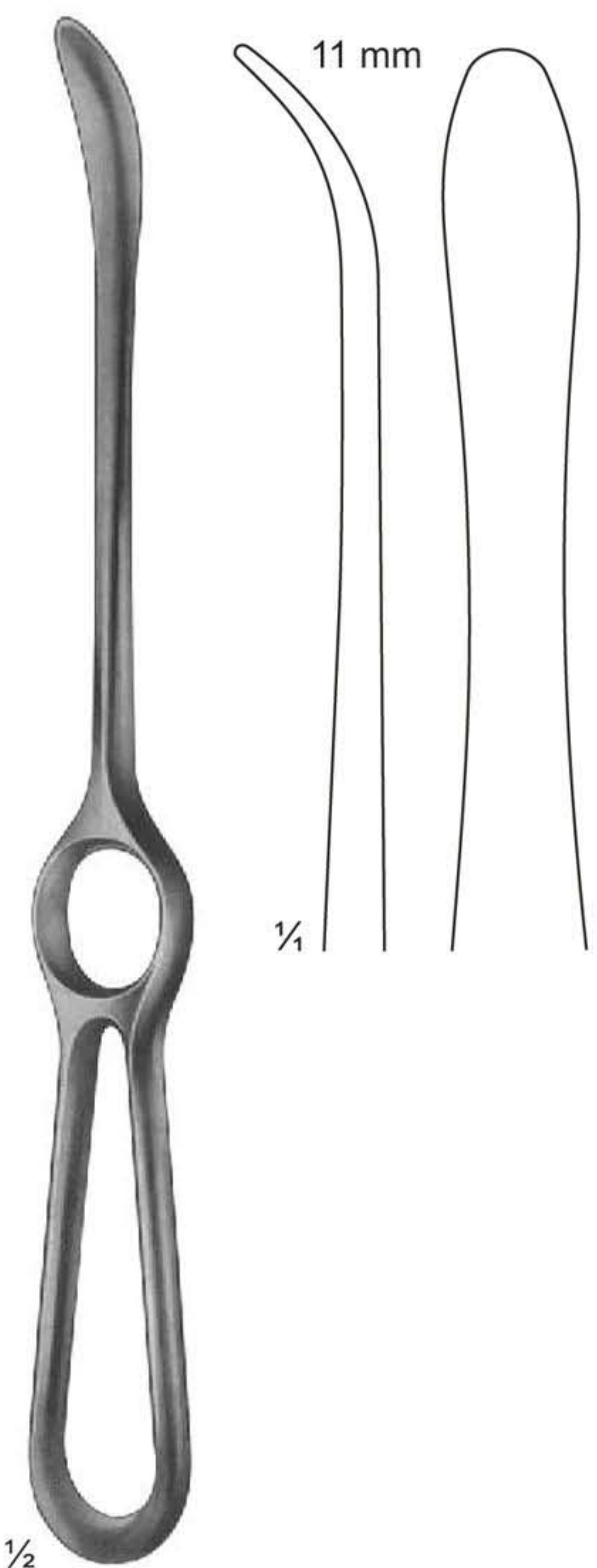

**20-108**  
LANGENBACK  
230mm



# Bone Levers

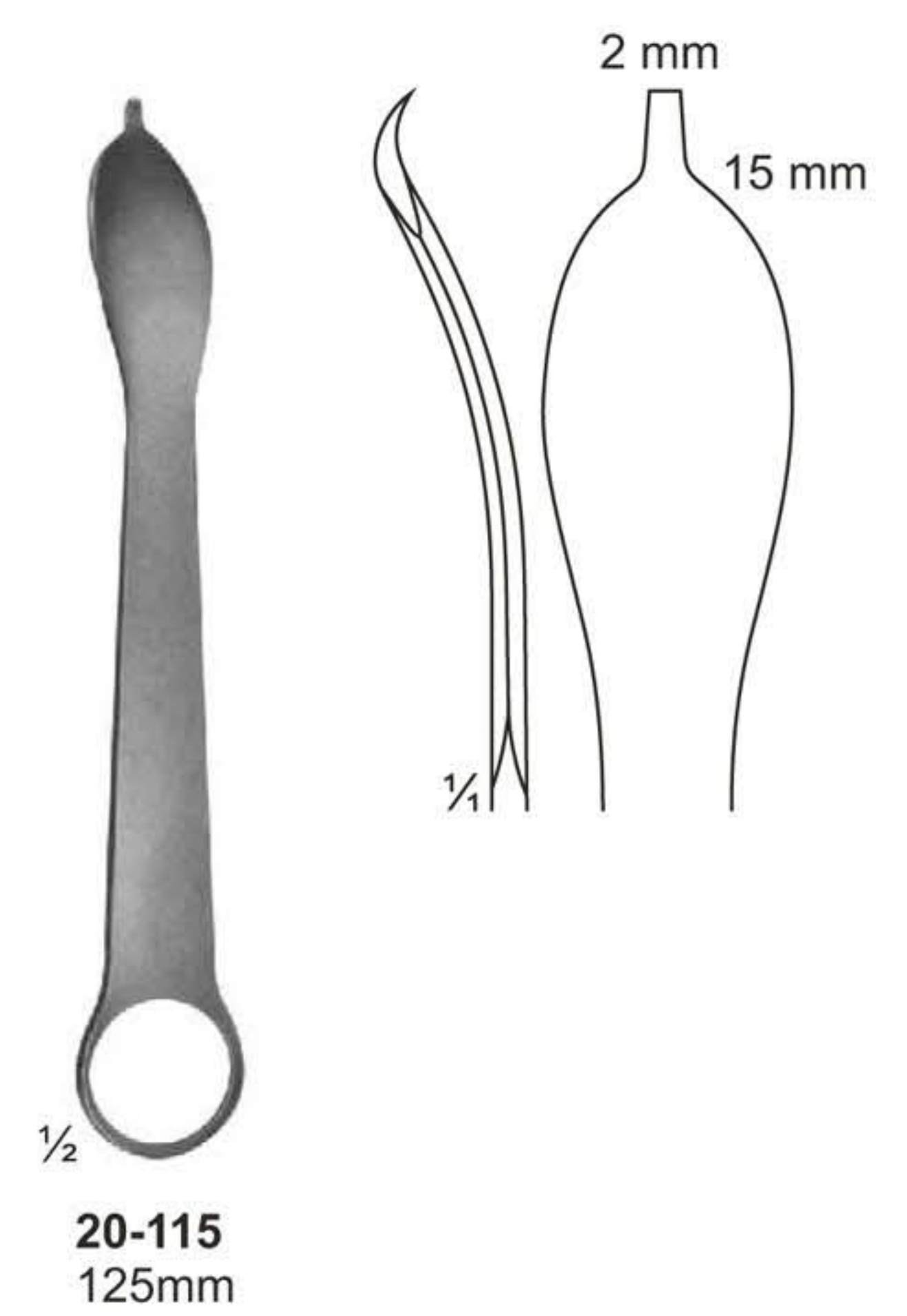
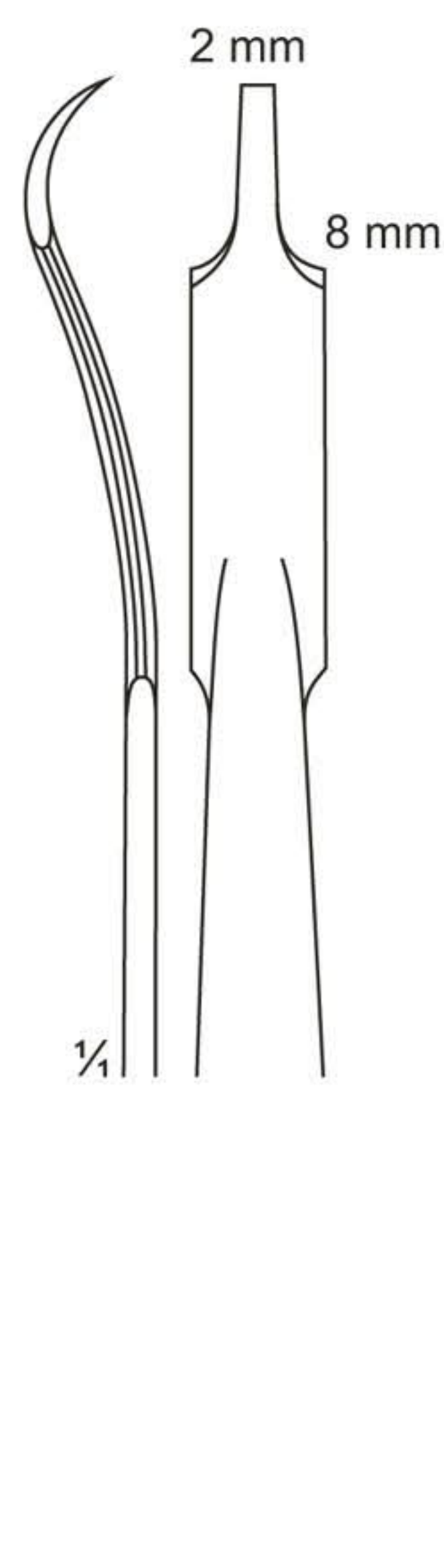
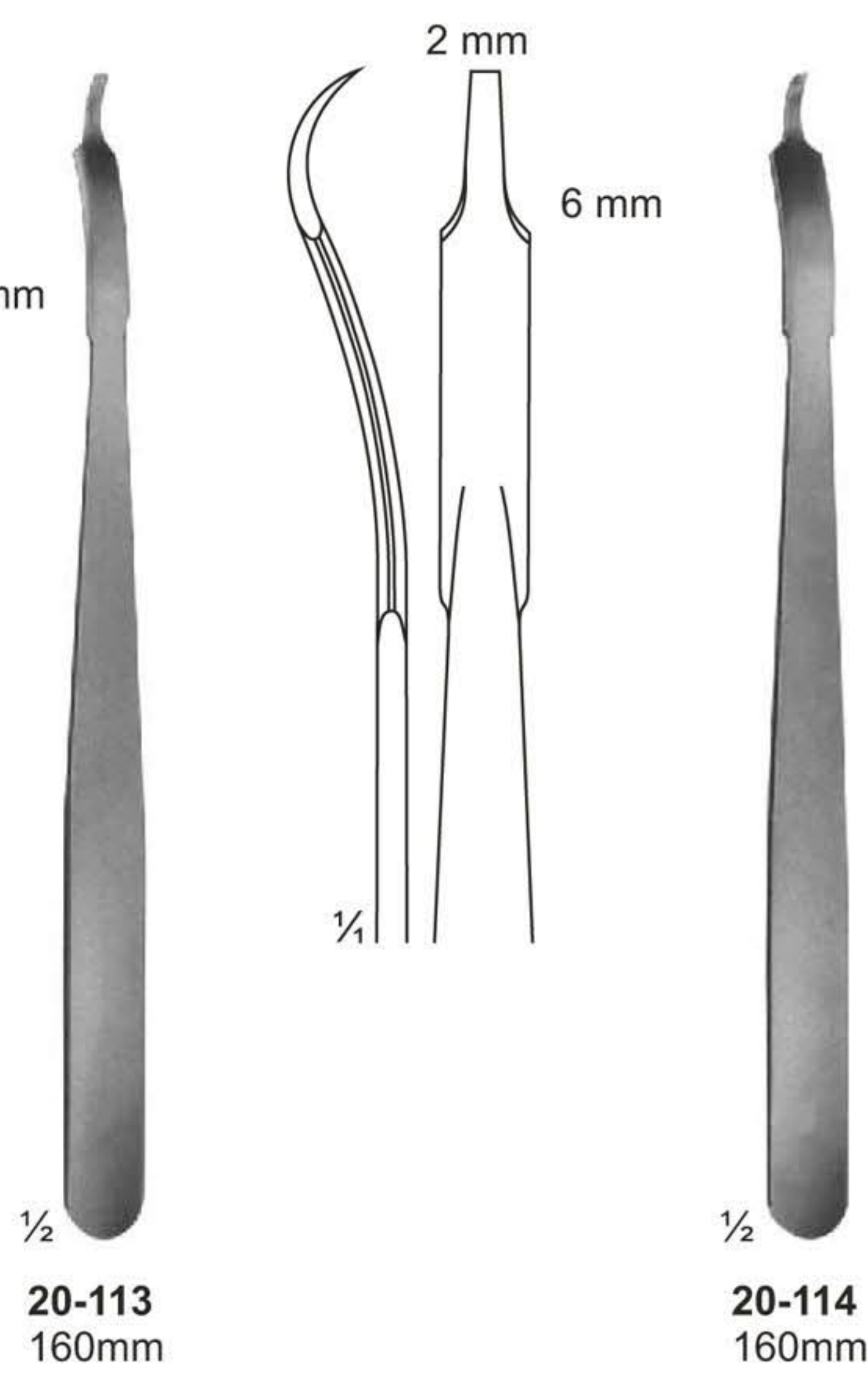
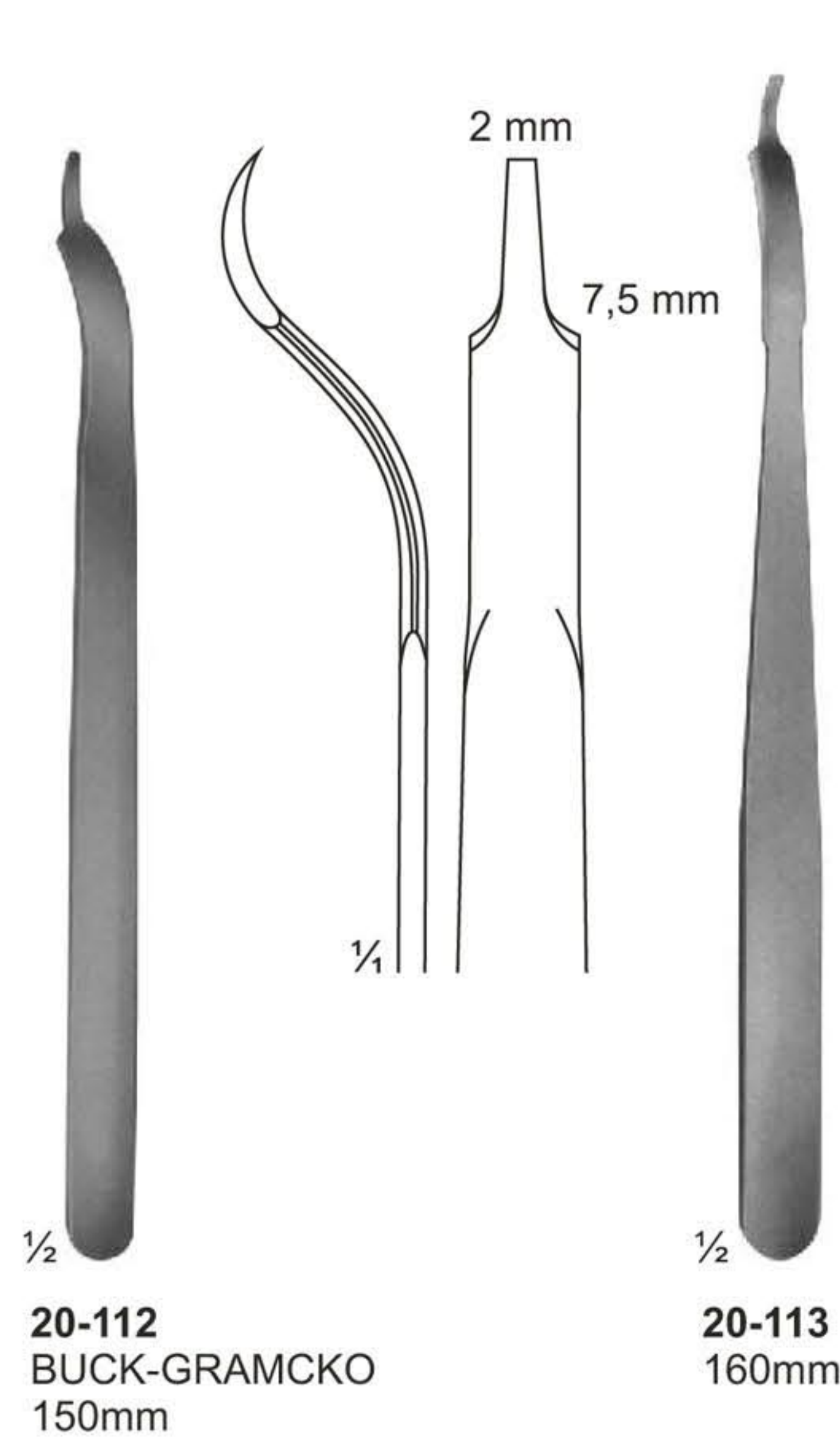
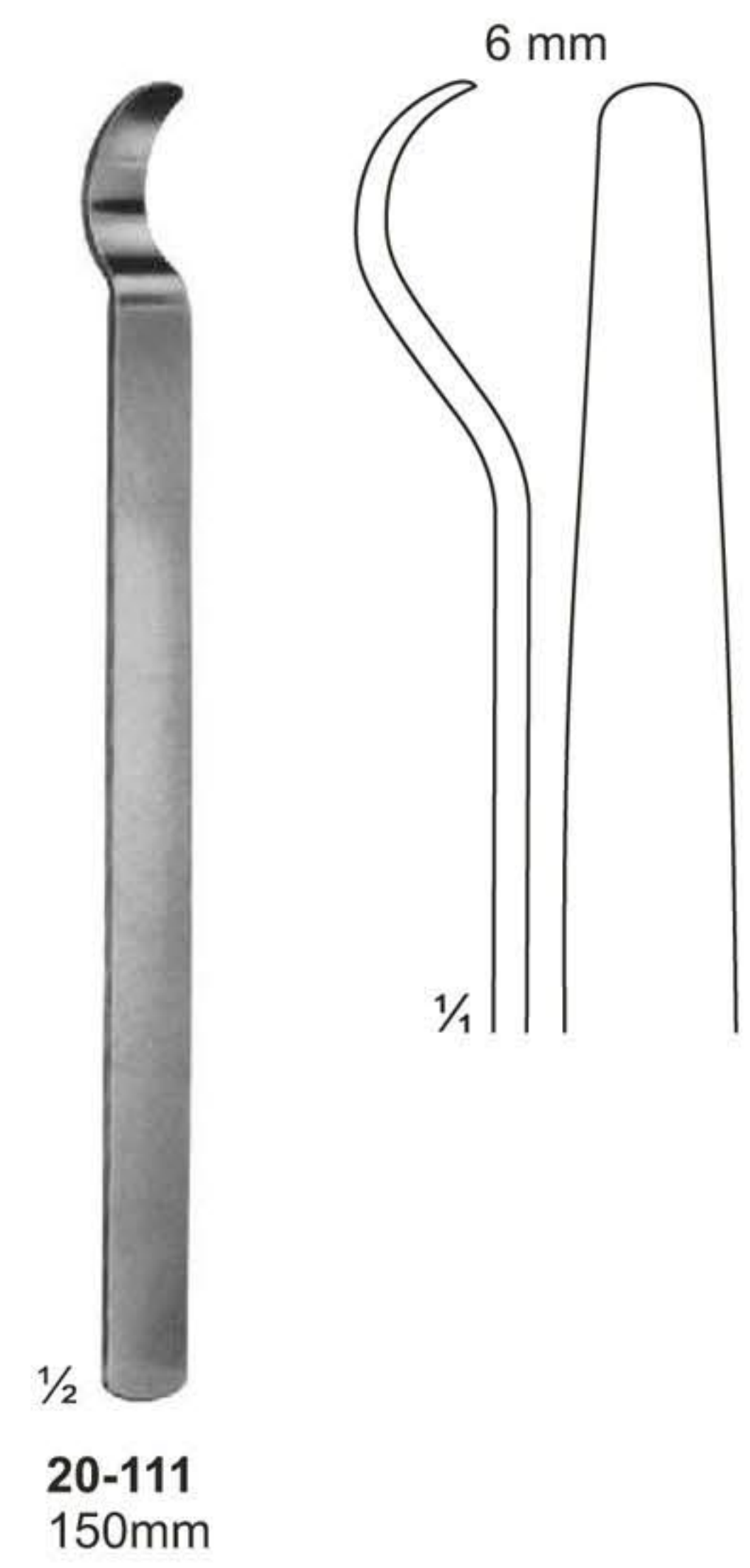
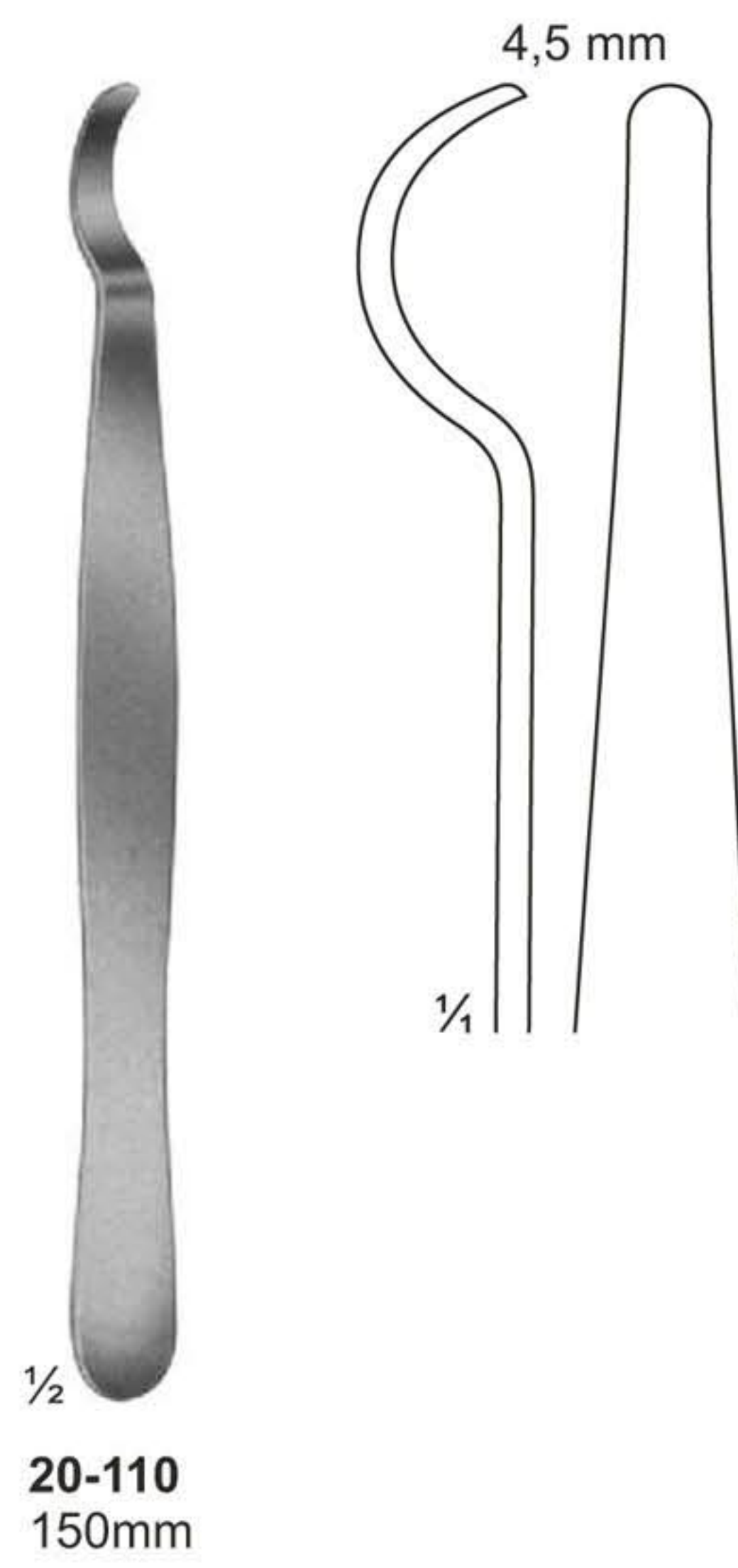
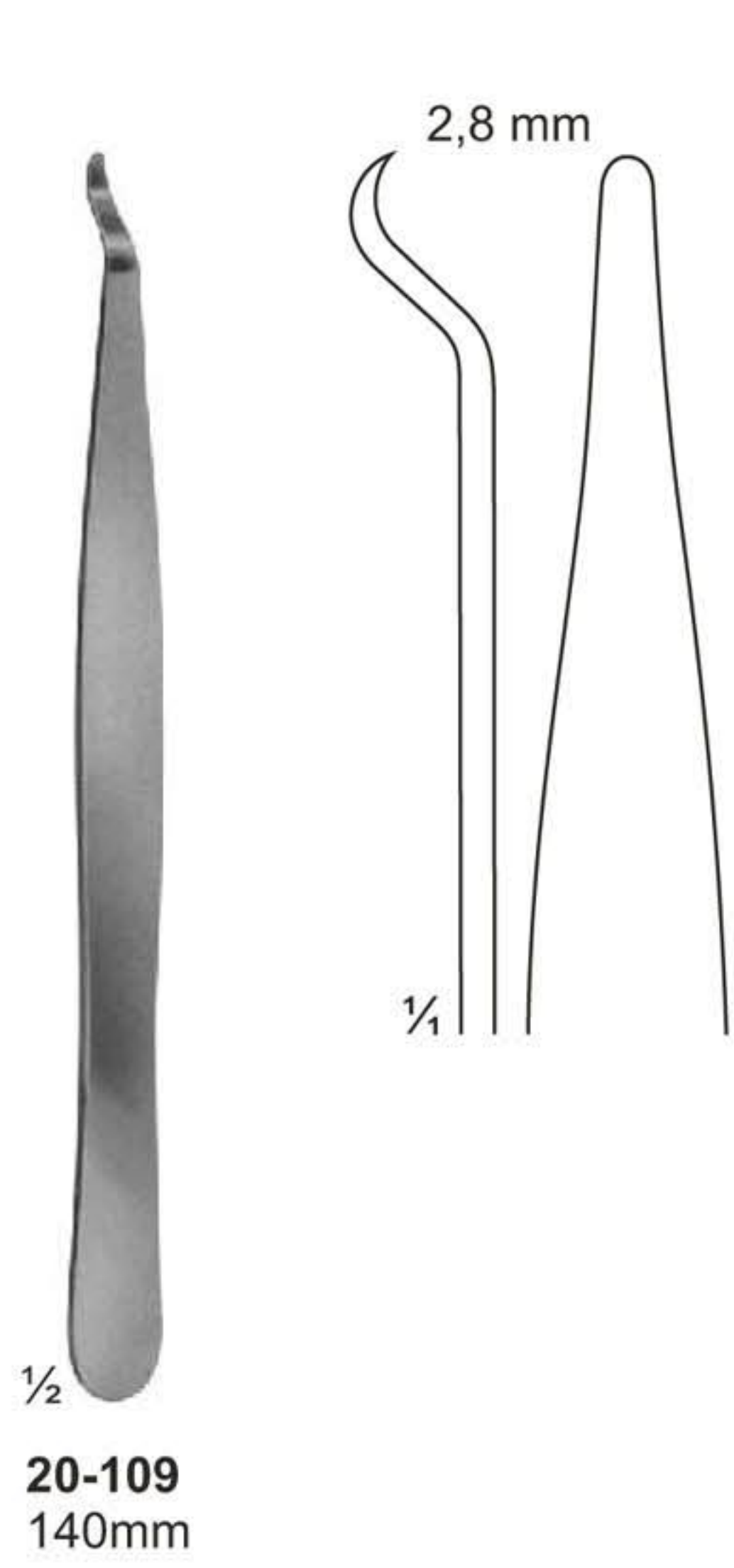



**Bone Levers**



**20-116**  
LANE TRETOWAN  
215mm

**20-117**  
LANE  
255mm

**20-118**  
LANGE-HOHMANN  
250mm

**20-119 - 120**  
LANGE-HOHMANN  
**20-119** 265mm  
**20-120** 280mm



**Bone Levers**



**20-121**  
WAGNER  
220 mm

**20-122**  
220 mm

**20-123**  
240 mm

**20-124**  
240 mm



**Bone Levers**

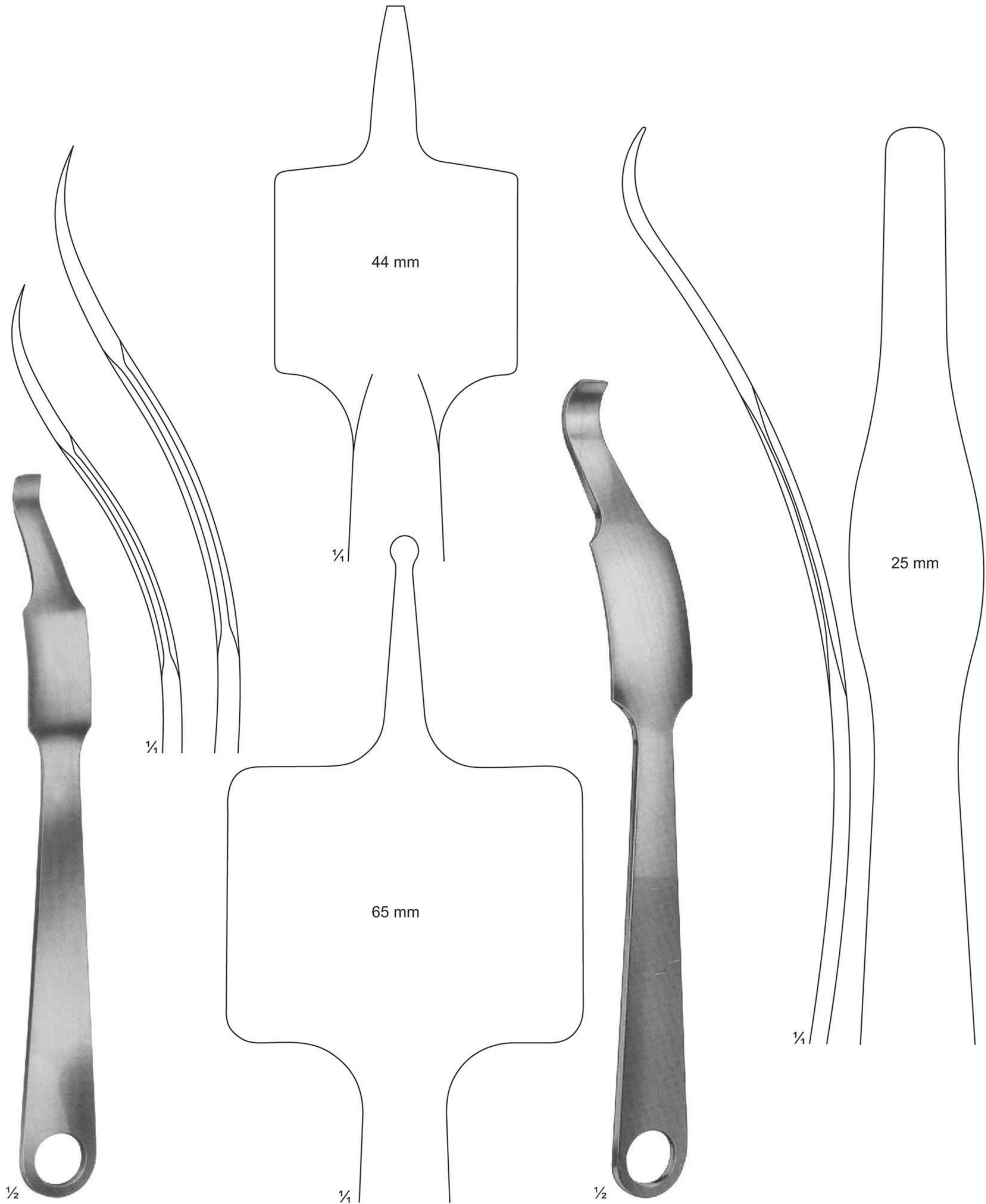

**20-125 - 126**  
**VERBRUGGE-MULLER**  
20-125 240 mm  
20-126 255 mm

**20-127**  
260 mm



**Bone Levers**

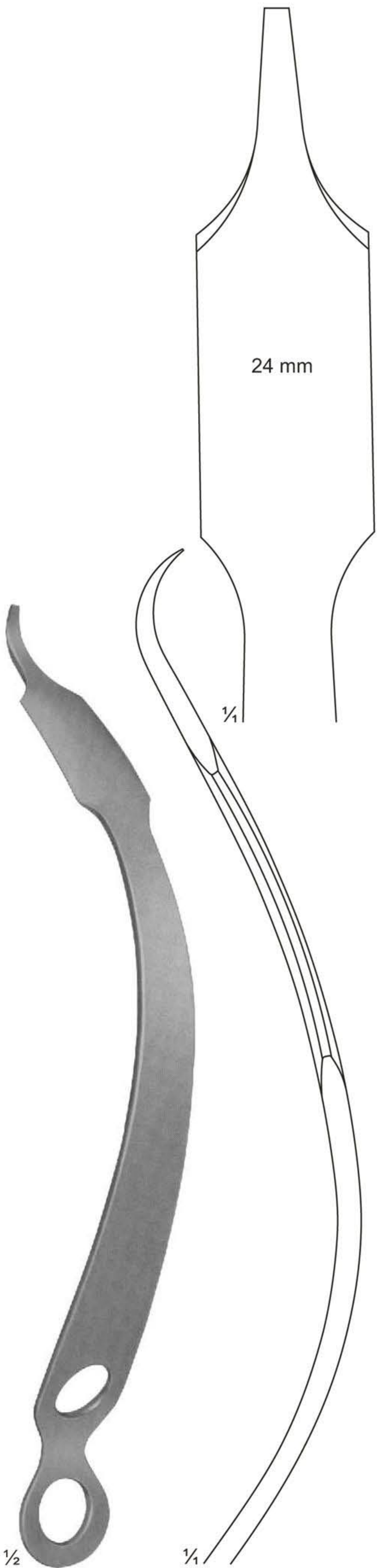

**20-128**  
HOHMANN-ALDINGER  
270 mm

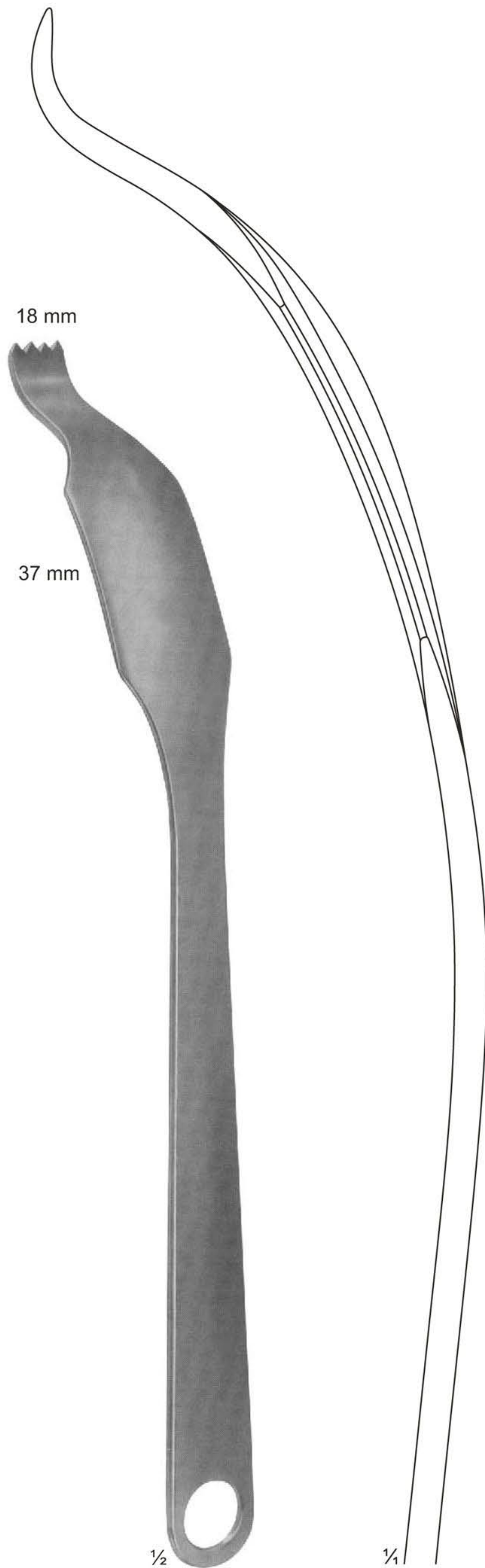

**20-129**  
SCHUMACHER mod. WAGNER  
345 mm

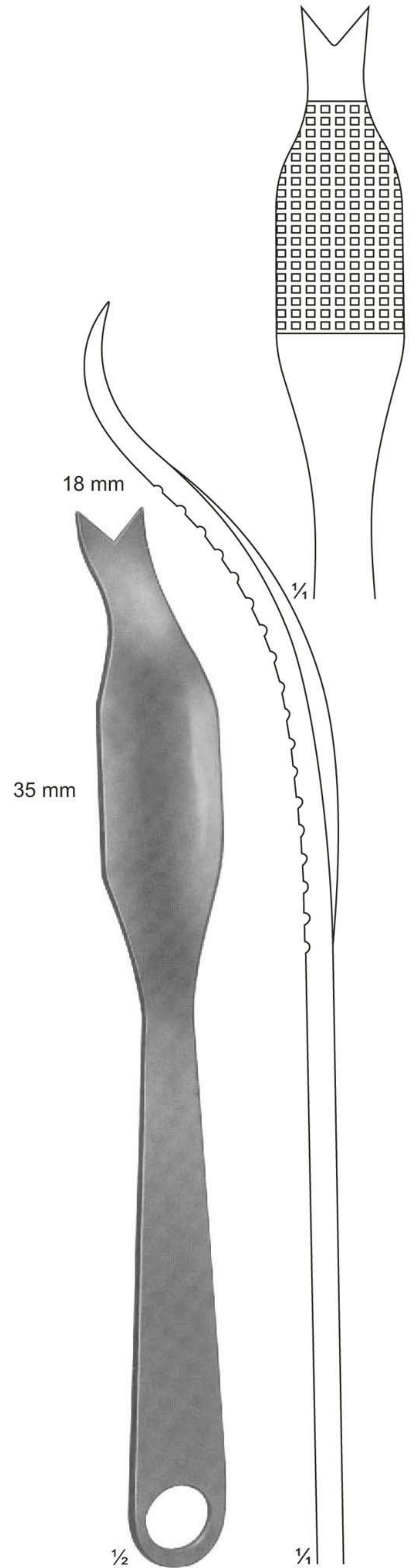

**20-130**  
SCHUMACHER  
290 mm



**Special Bone Levers**

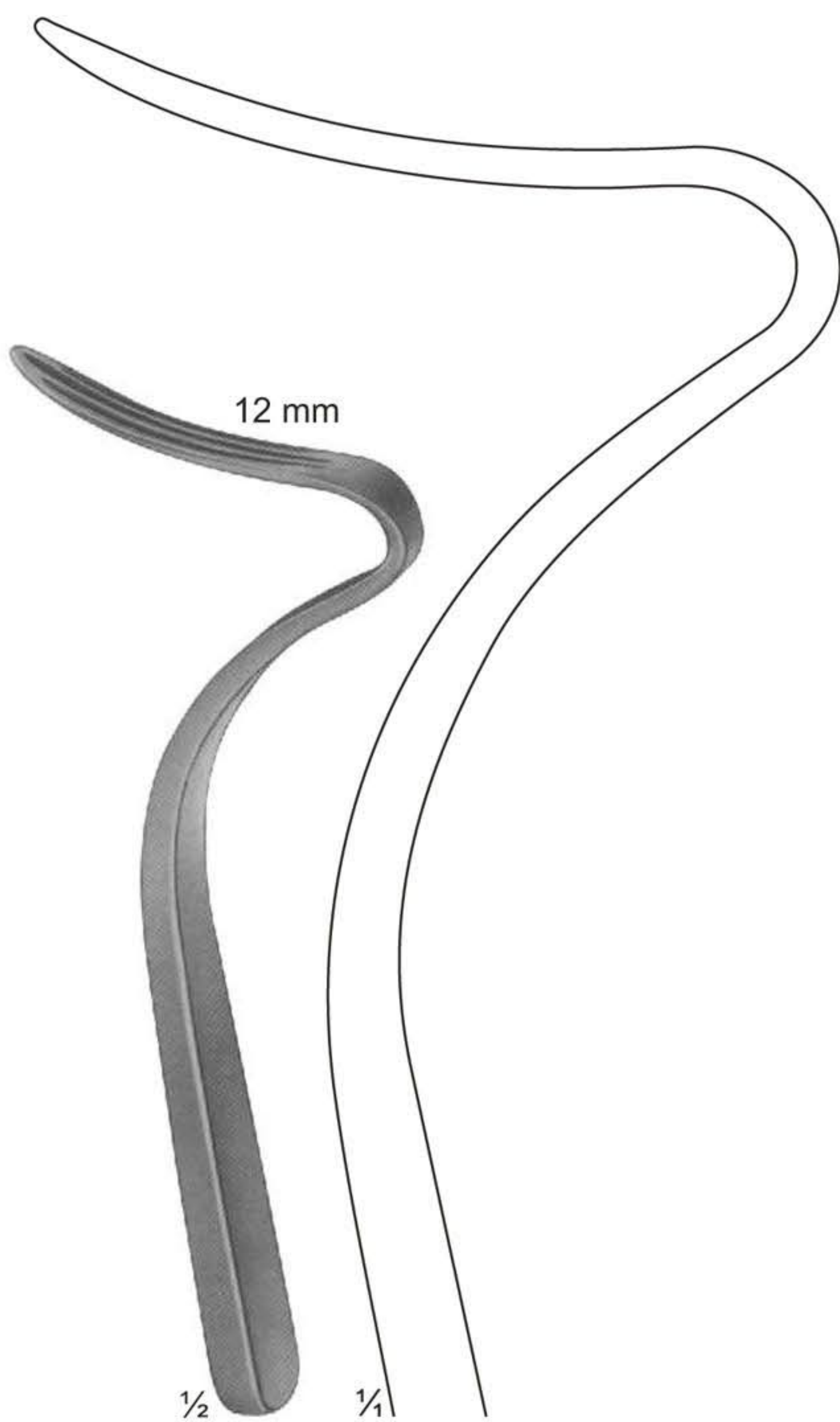

**20-131**  
**TAGER**  
Bone lever for  
angle joint operations  
175 mm

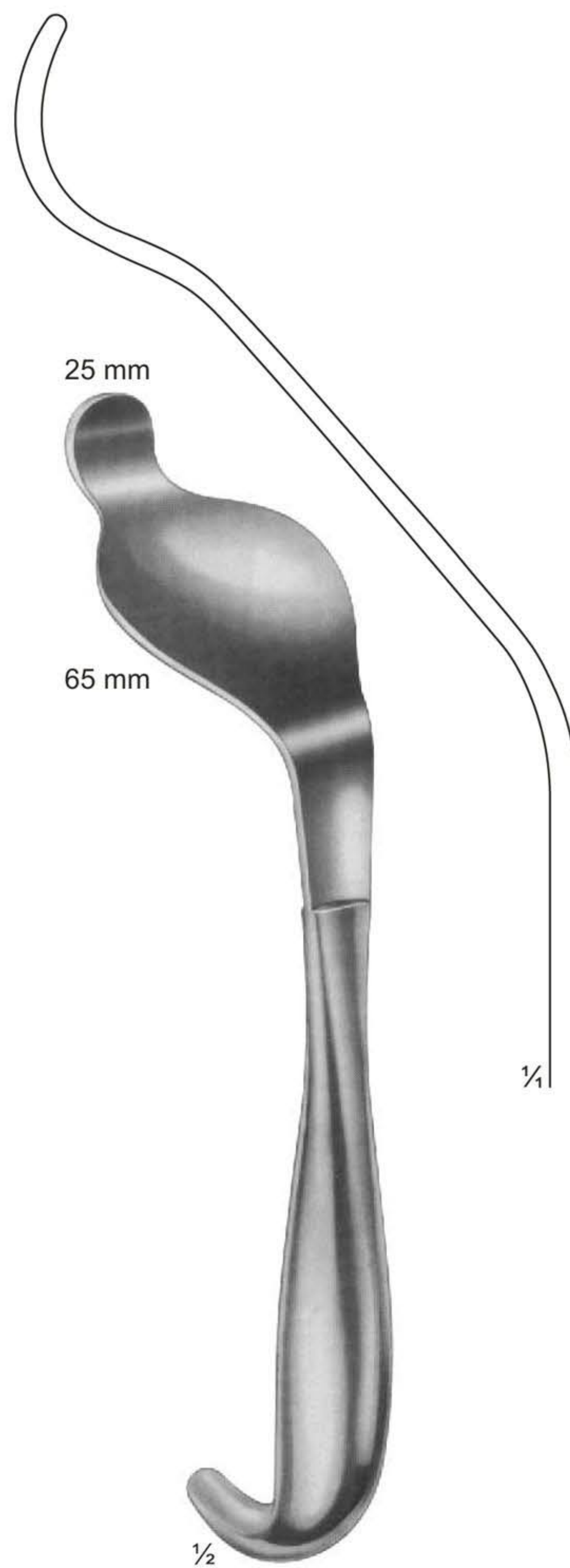

**20-132**  
**BENNETT**  
235 mm

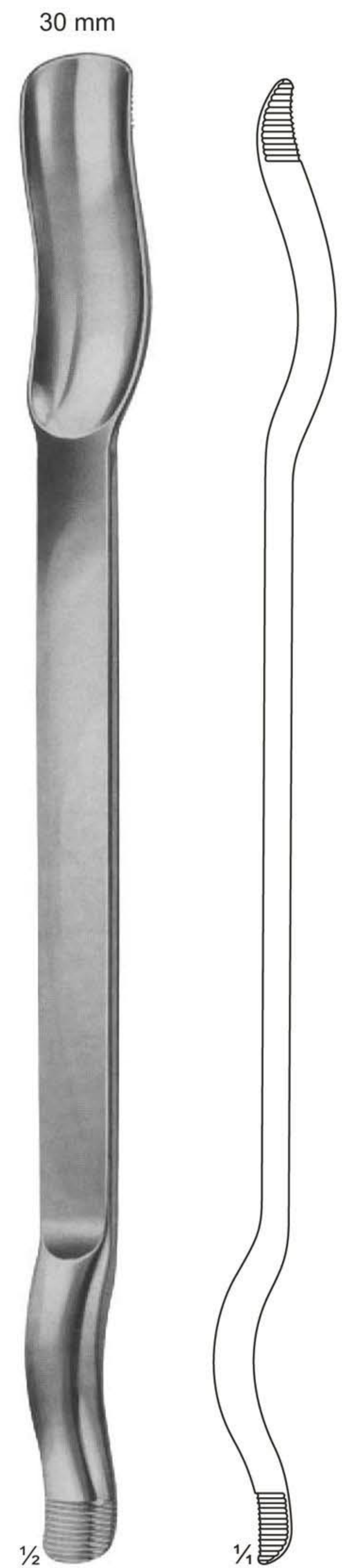

**20-133**  
**MURPHY-LANE**  
Luxation lever  
340 mm



**Raspatories**

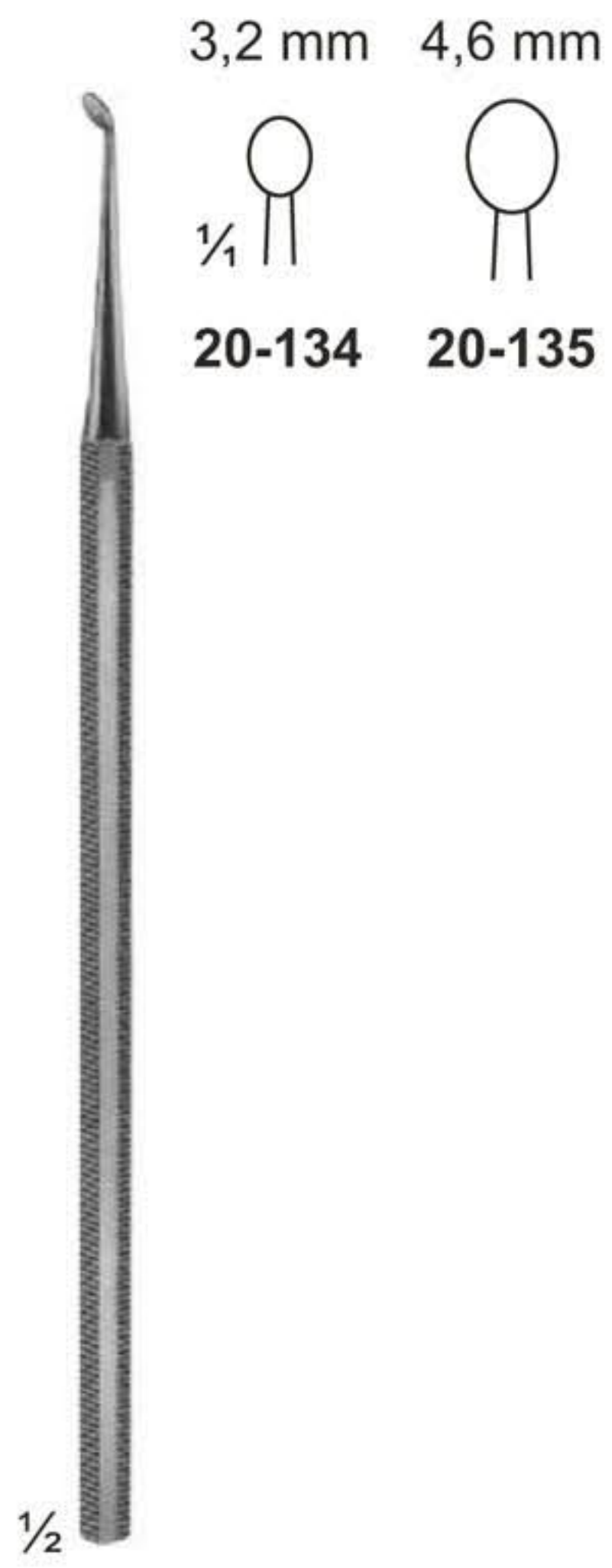

**20-134 - 135**  
PARTSCH  
150 mm

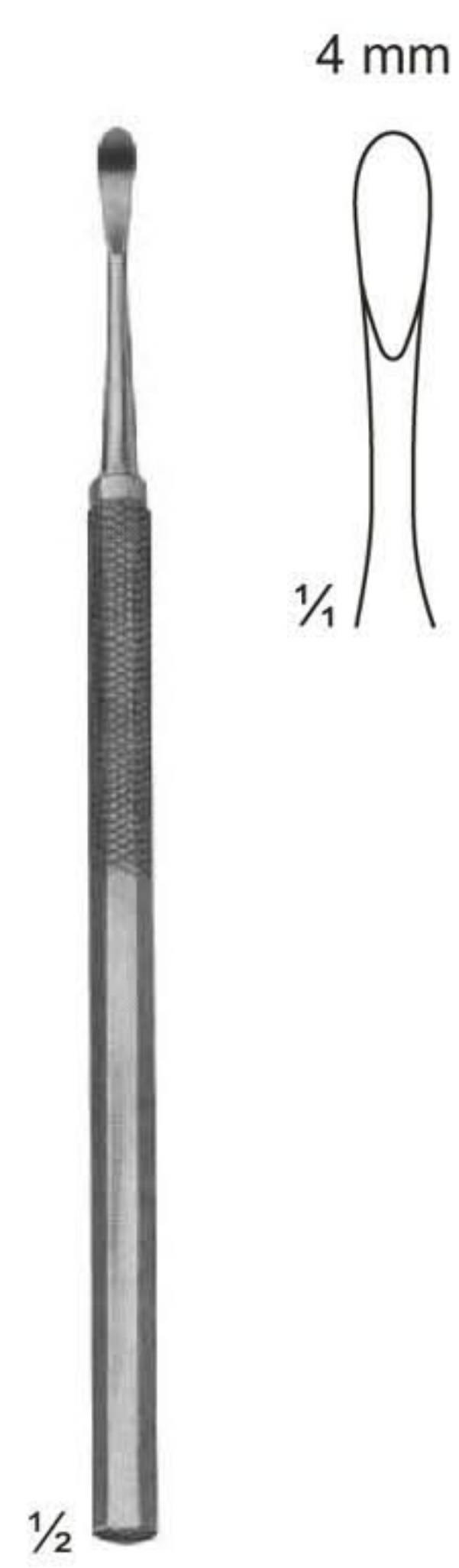

**20-136**  
PARTSCH mod. LANGE  
145 mm



**20-137**  
MC KENTY  
155 mm

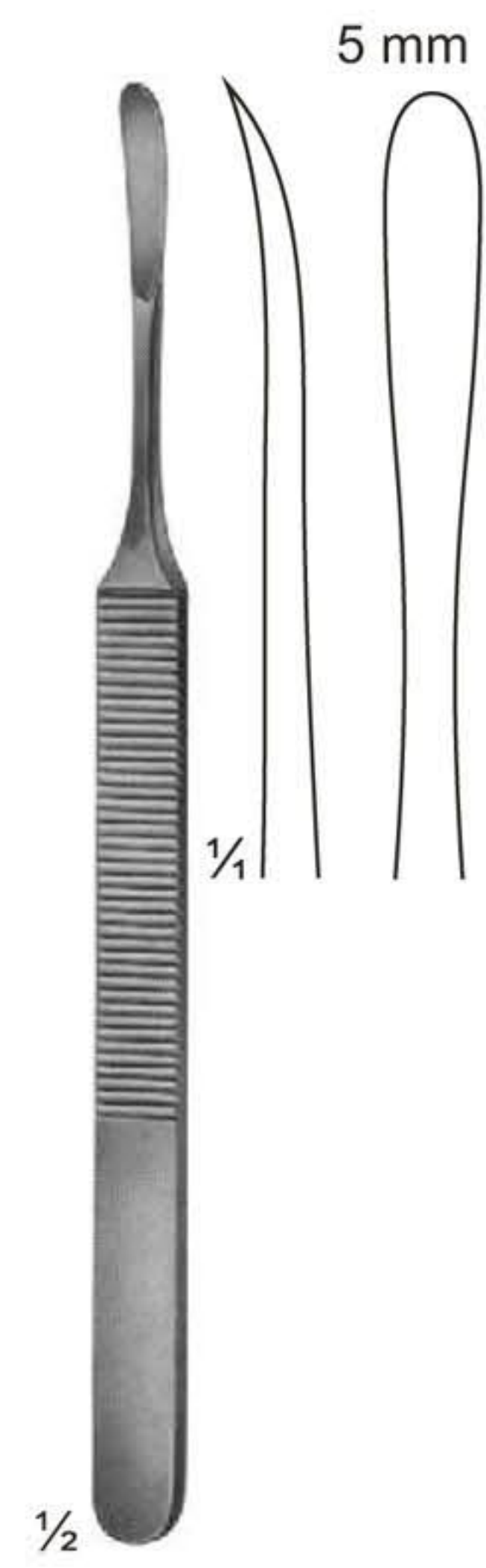

**20-138**  
KONIG  
155 mm

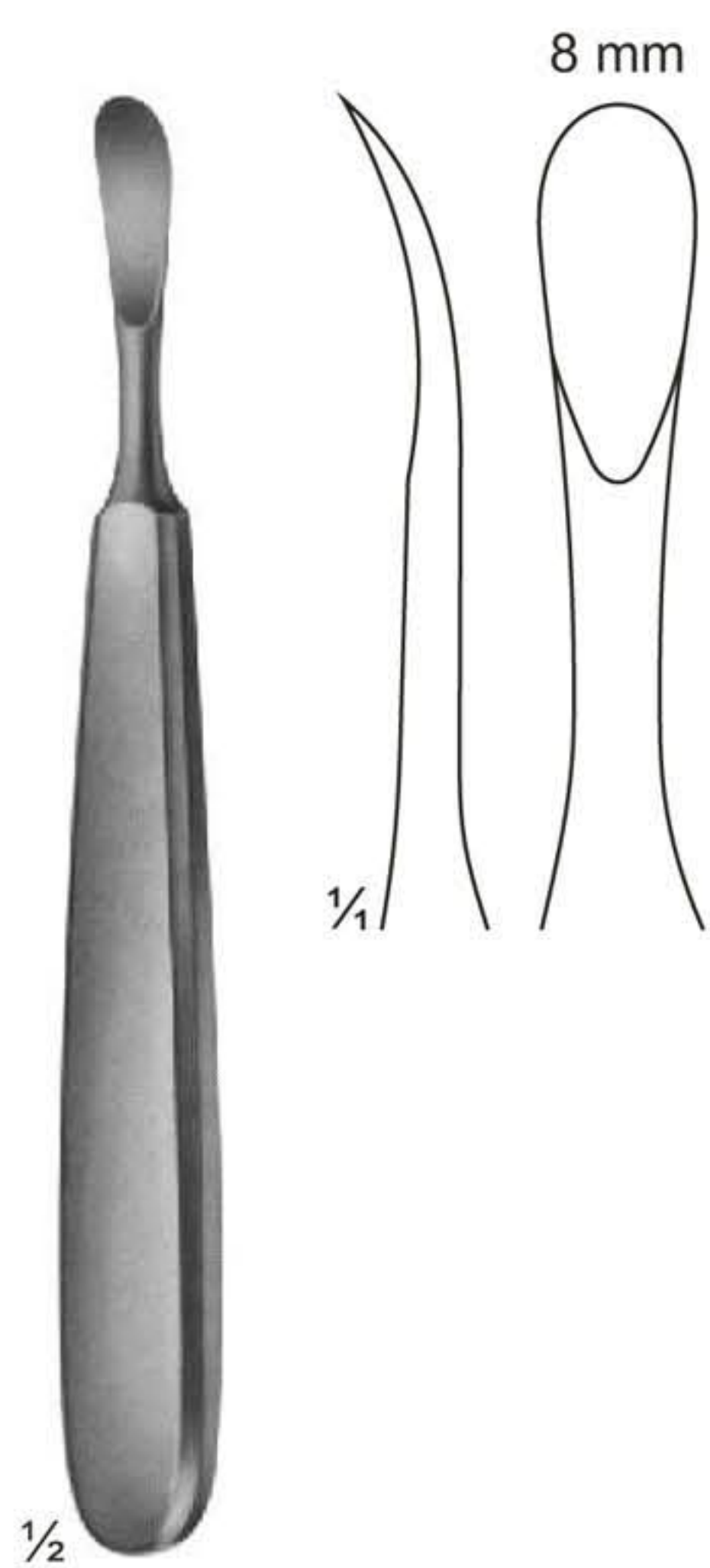

**20-139**  
TRELAT  
150 mm

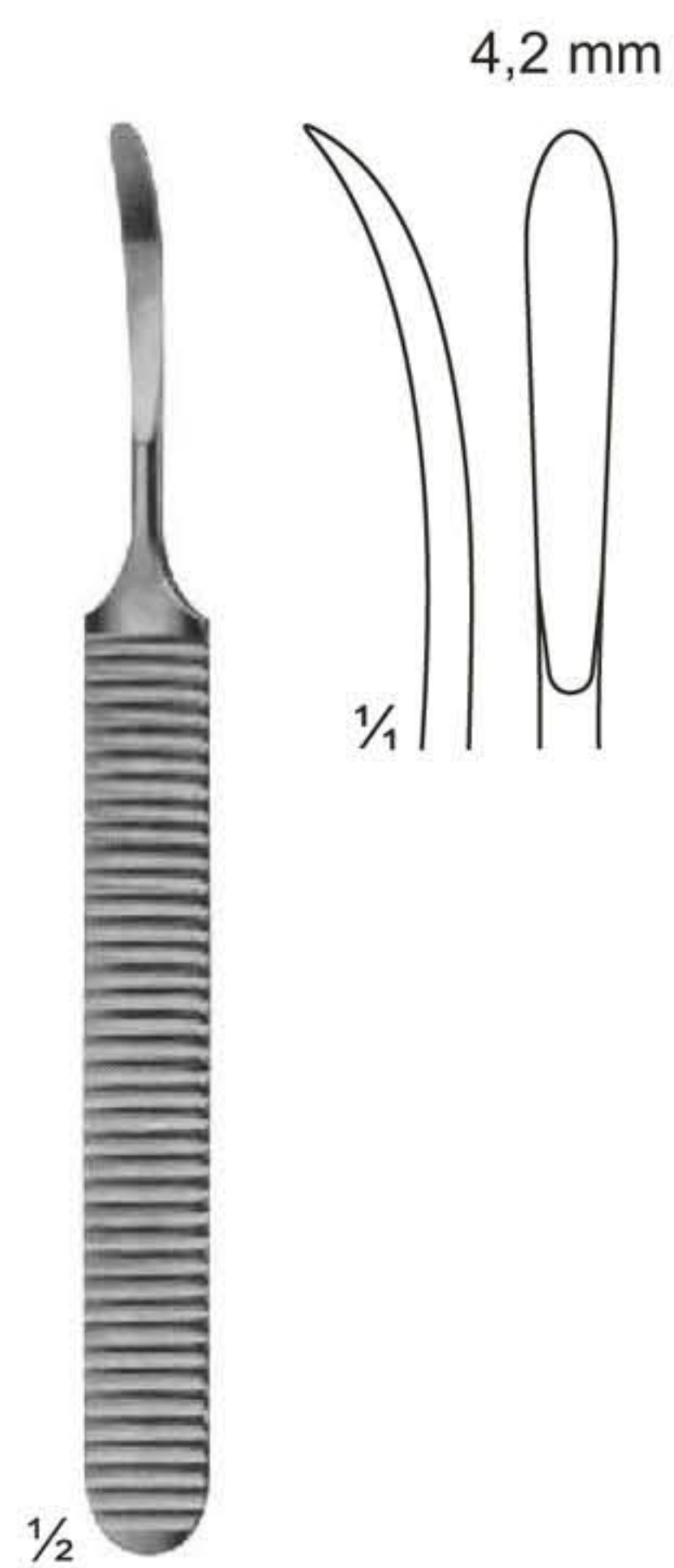

**20-140**  
WILLIGER  
140 mm

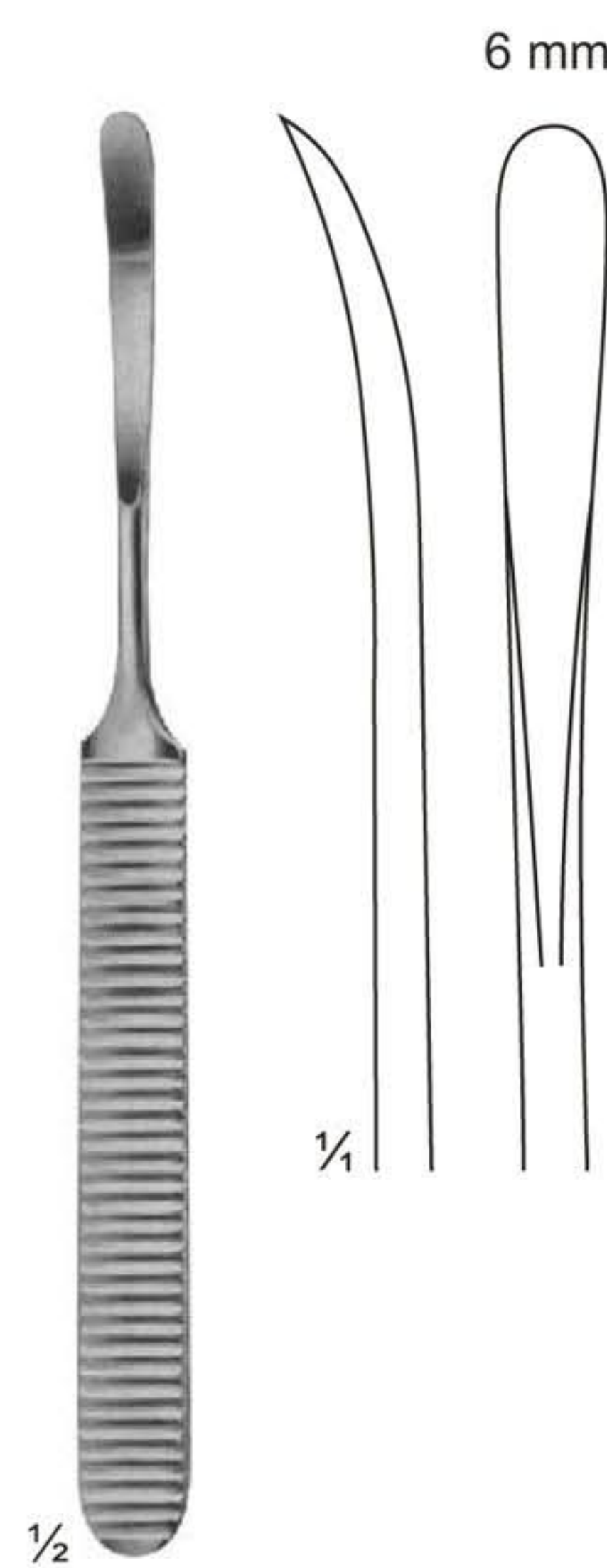

**20-141**  
WILLIGER  
160 mm

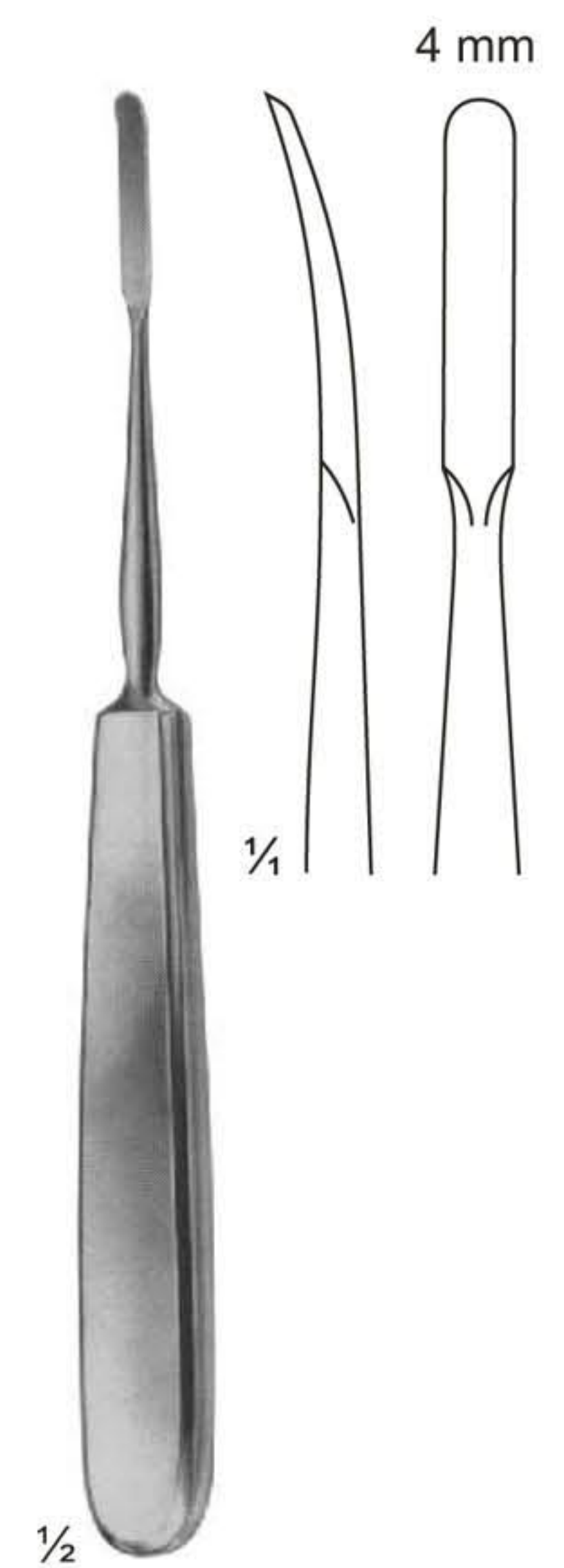

**20-142**  
JOSEPH  
170 mm



# Raspatories

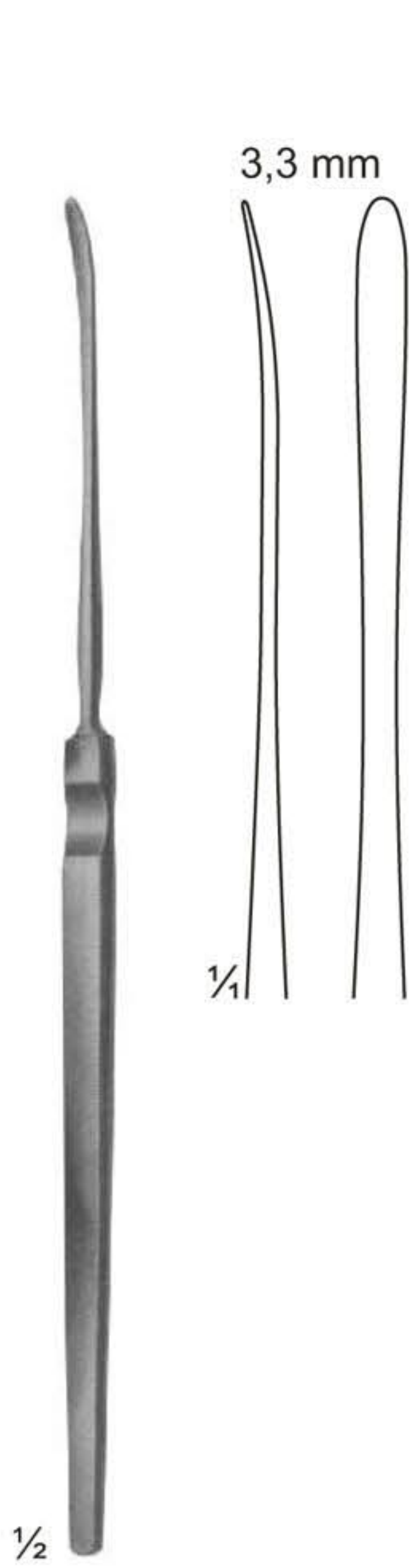

**20-143**  
HALLE  
stumfp/blunt  
180 mm



**20-144**  
FREER  
stumfp/blunt  
190 mm



**20-145**  
FREER  
stumfp/sharp  
190 mm



**20-146**  
SEWALL  
stumfp/blunt  
190 mm

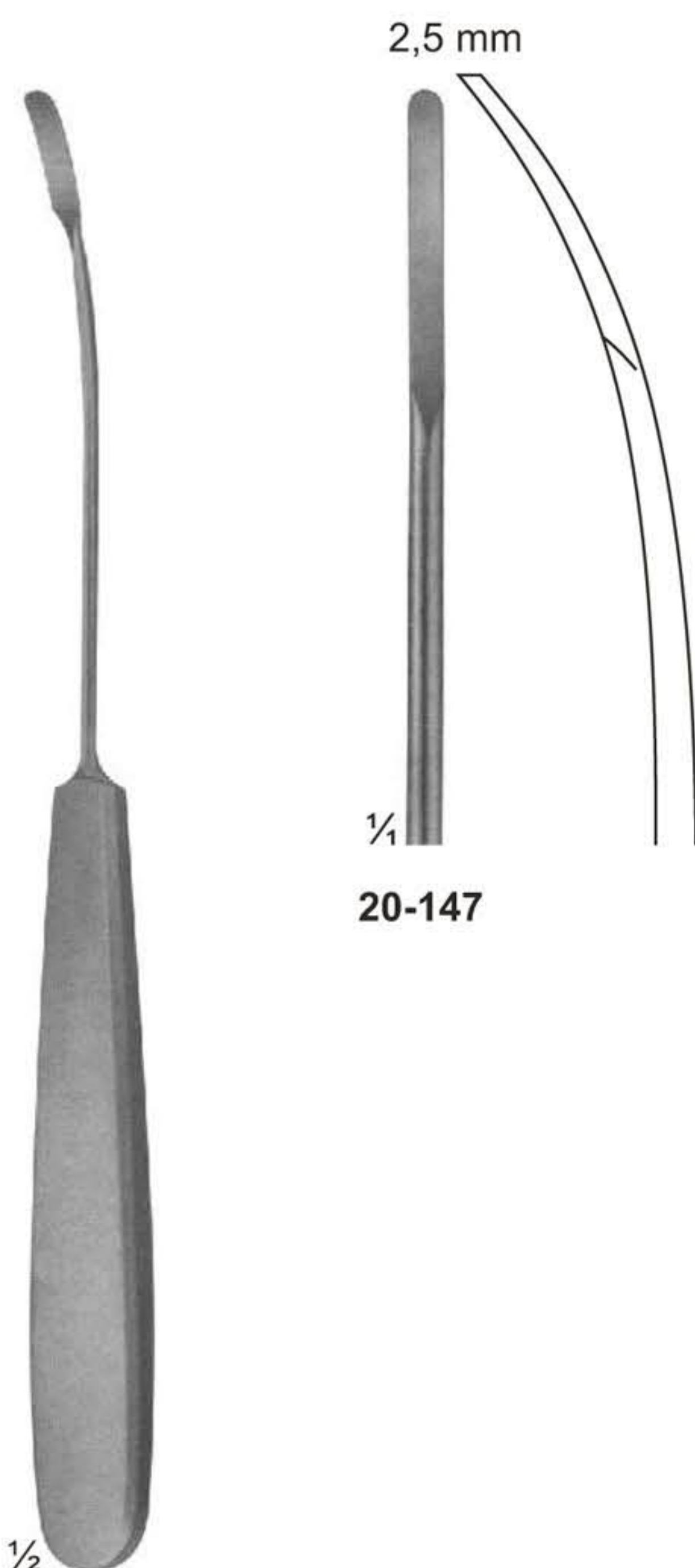

**20-147**

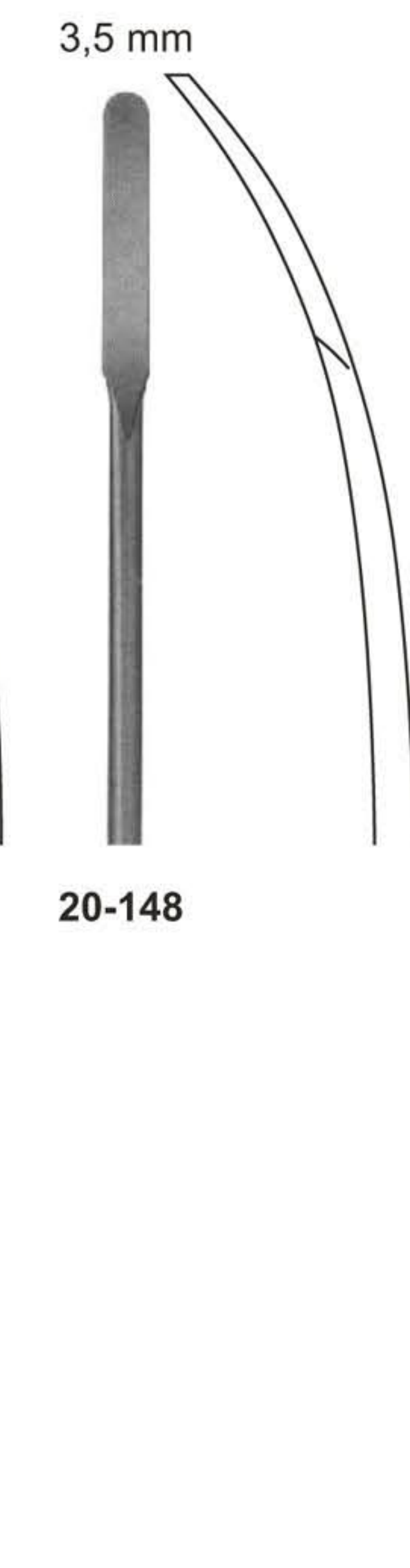

**20-148**

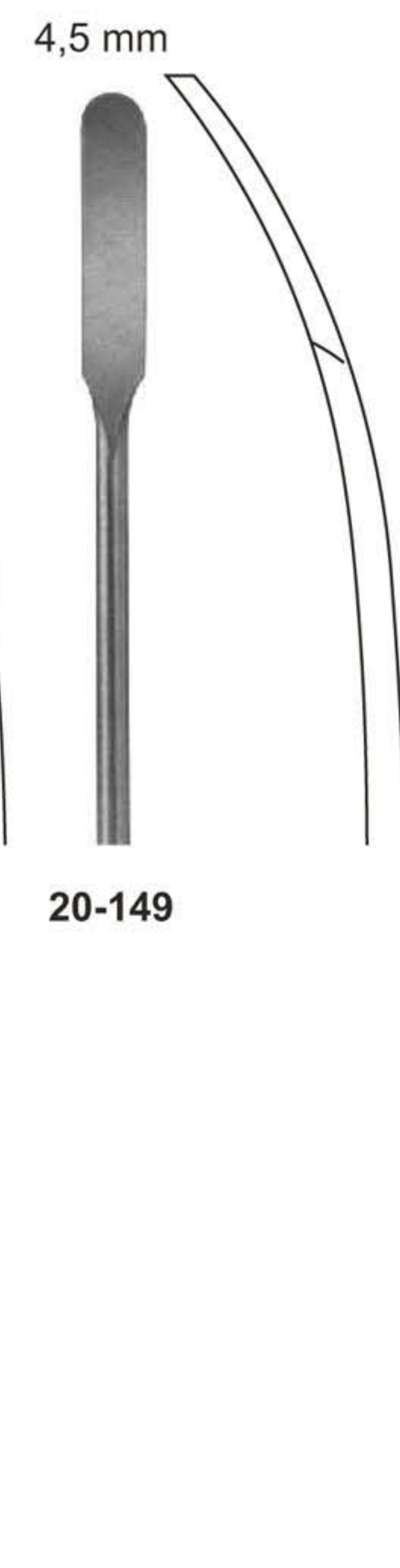

**20-149**

**20-147 - 149**  
PAULSEN  
205 mm

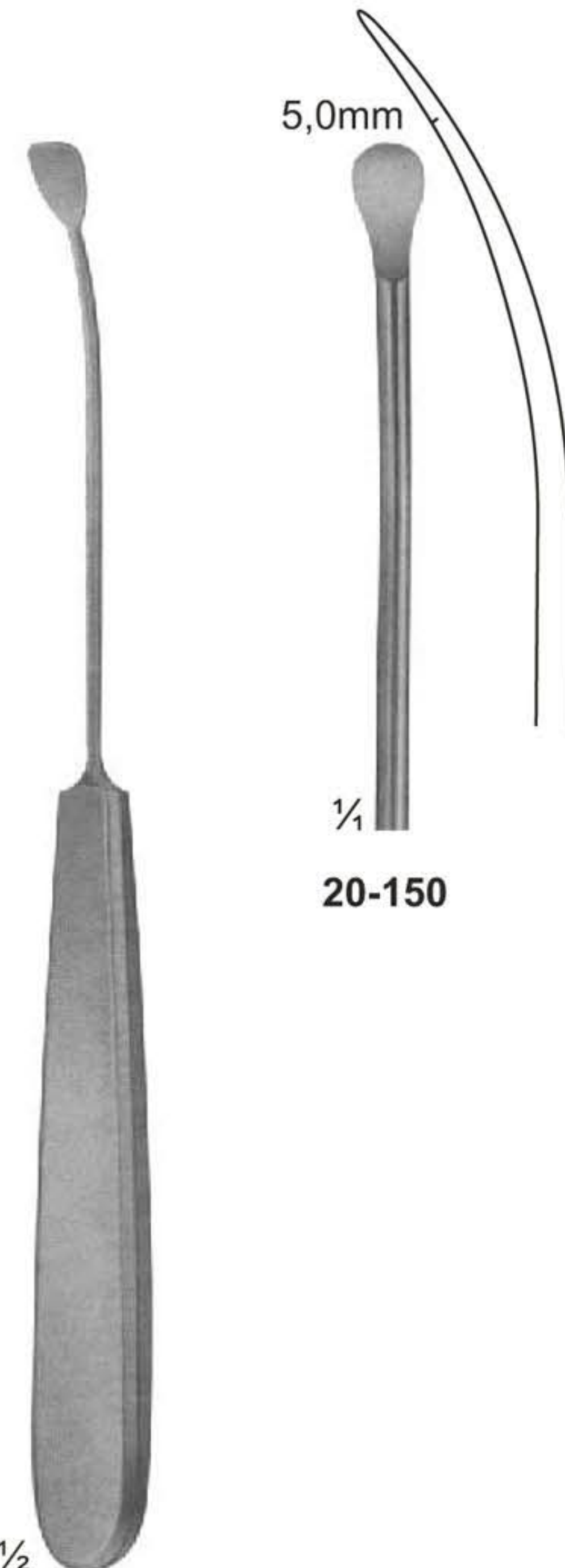

**20-150**

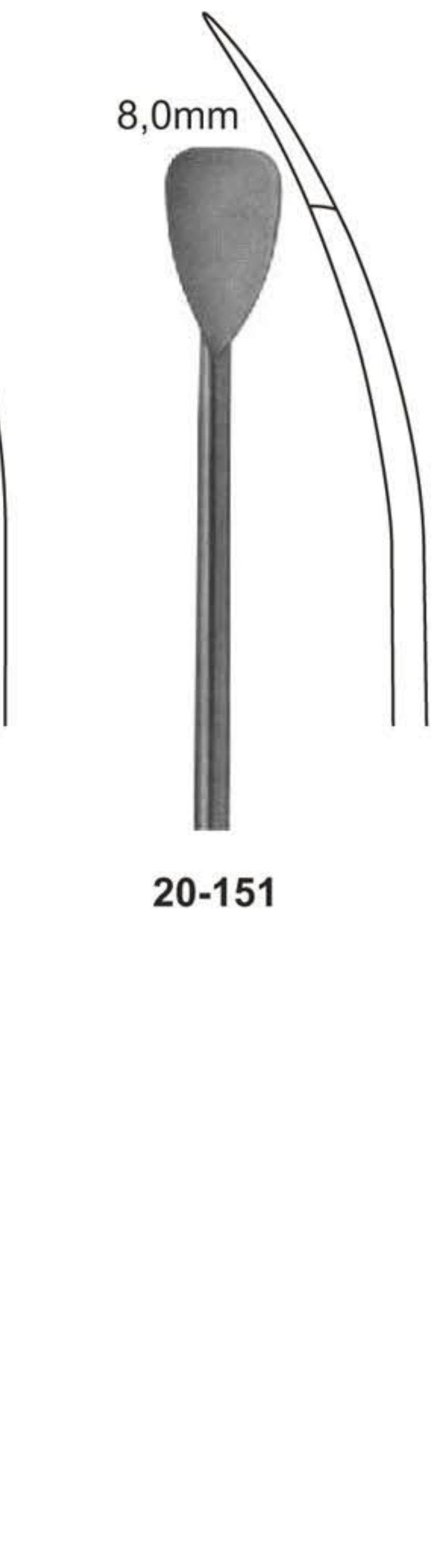

**20-151**

**20-150 - 151**  
PAULSEN  
205 mm



# Raspatories

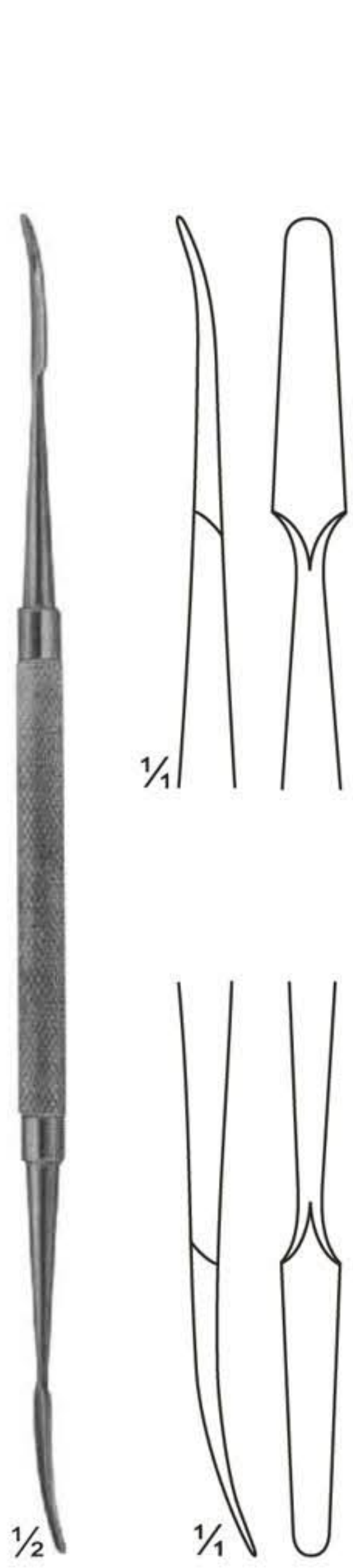

**20-152**  
KILLIAN  
sharp/blunt  
185 mm

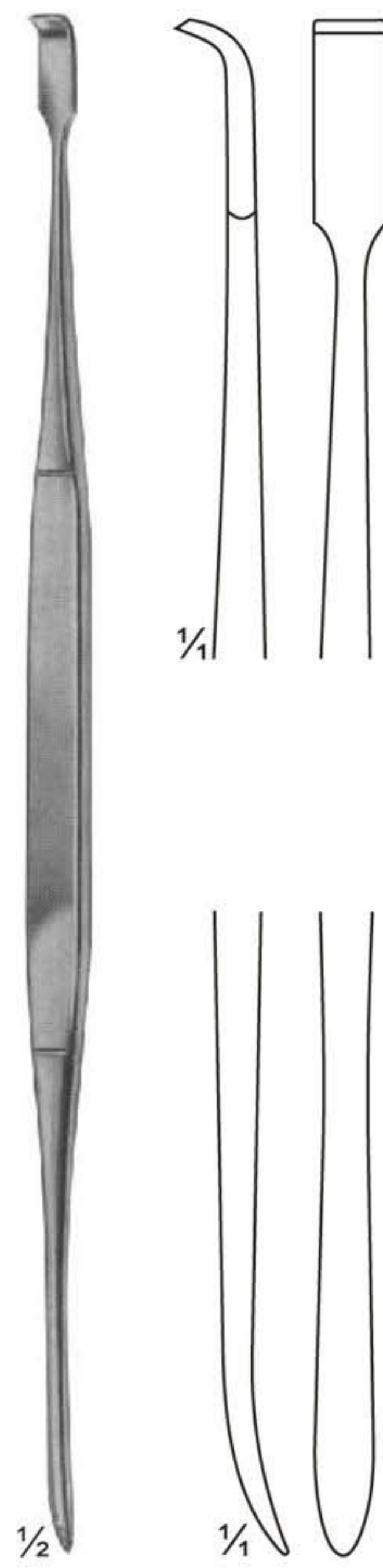

**20-153**  
HOWARTH  
sharp/blunt  
215 mm

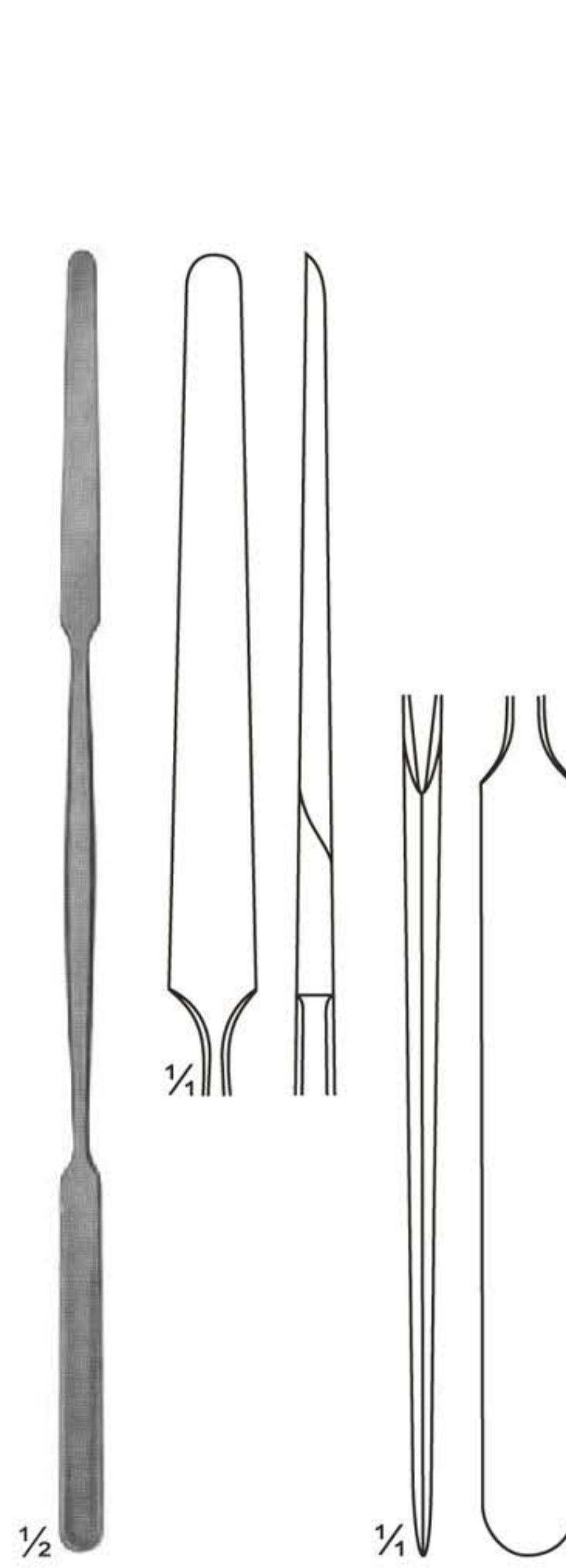

**20-154**  
KILLIAN  
sharp/blunt  
185 mm

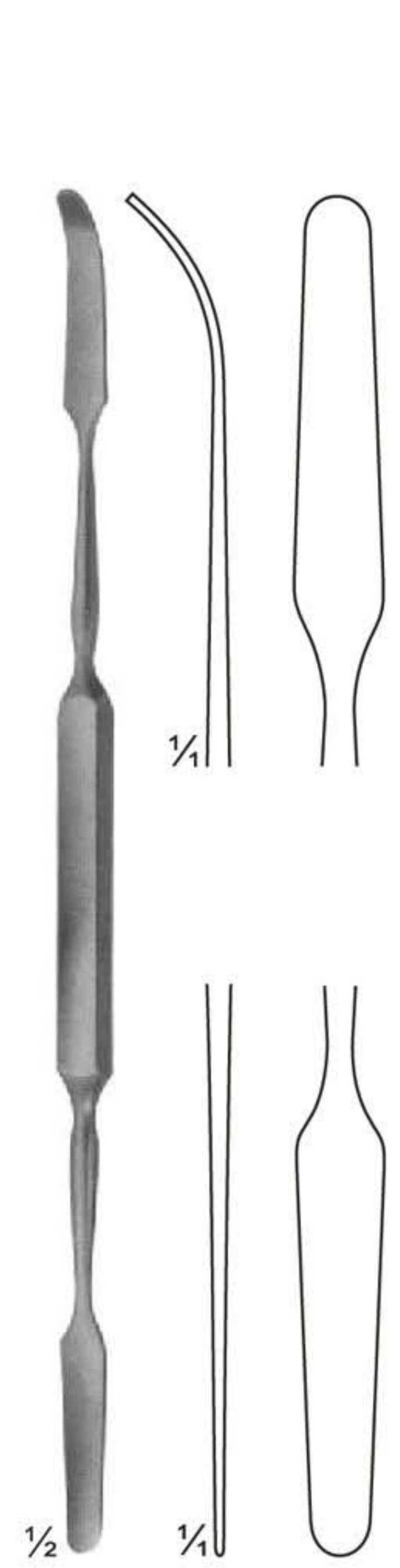

**20-155**  
MAC DONALD  
blunt/blunt  
185 mm

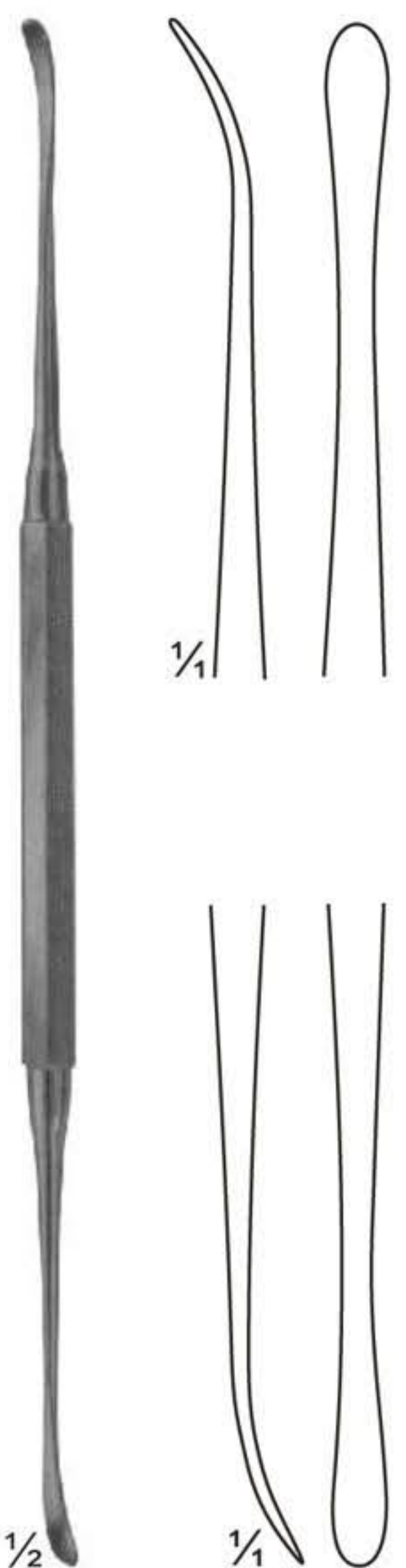

**20-156**  
FREER  
sharp/blunt  
185 mm

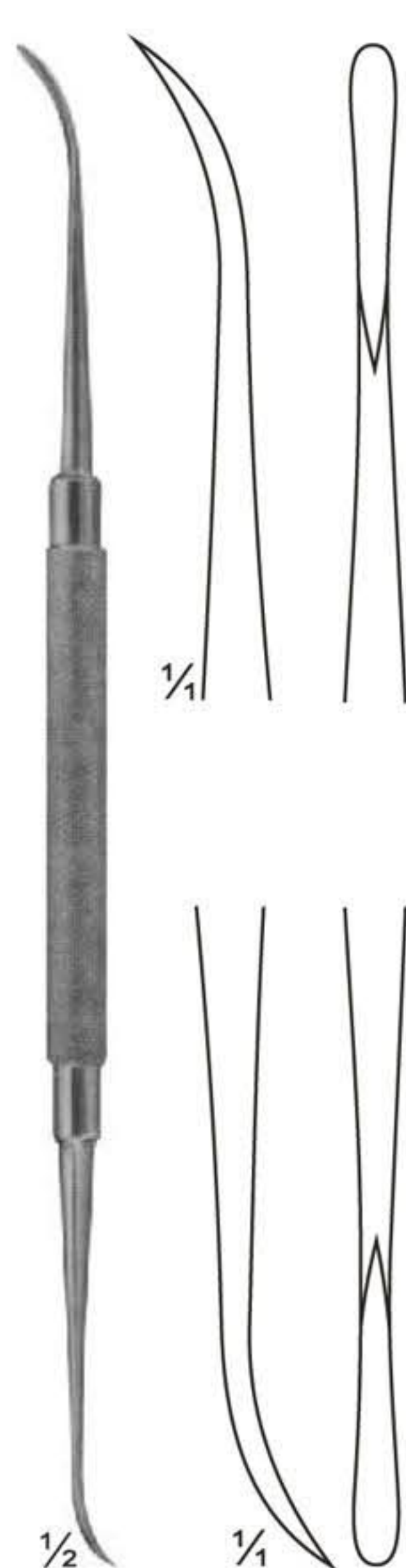

**20-157**  
FREER-YASARGIL  
sharp/sharp  
185 mm

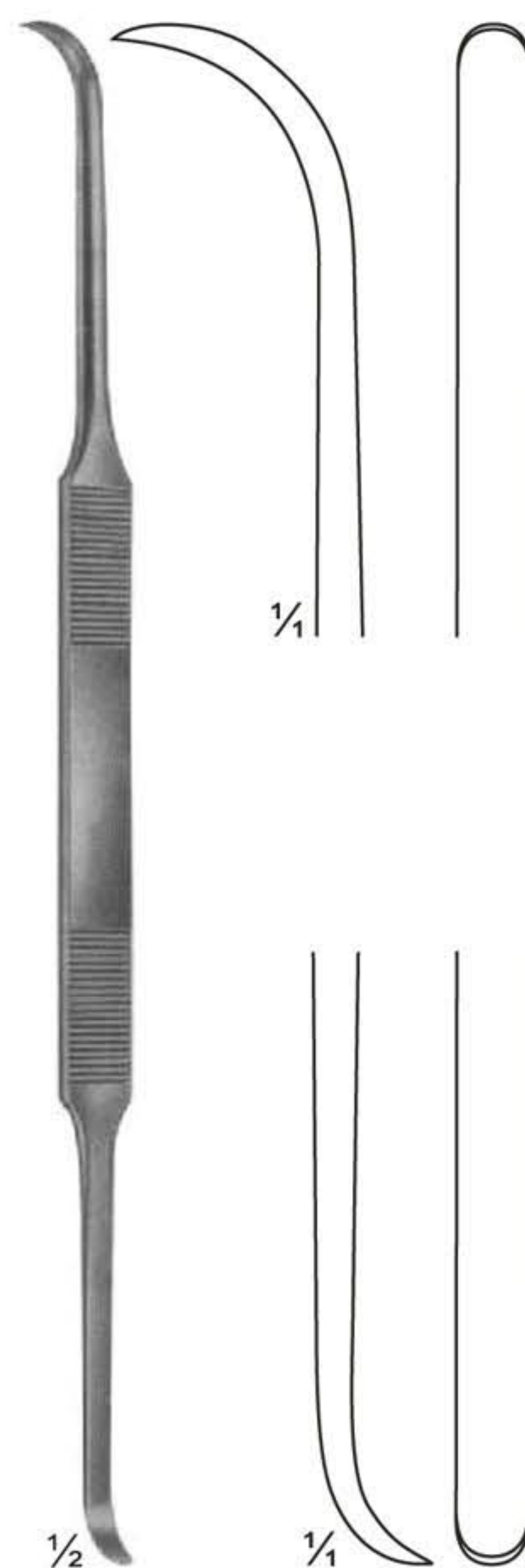

**20-158**  
COTTLE  
sharp/sharp  
200 mm

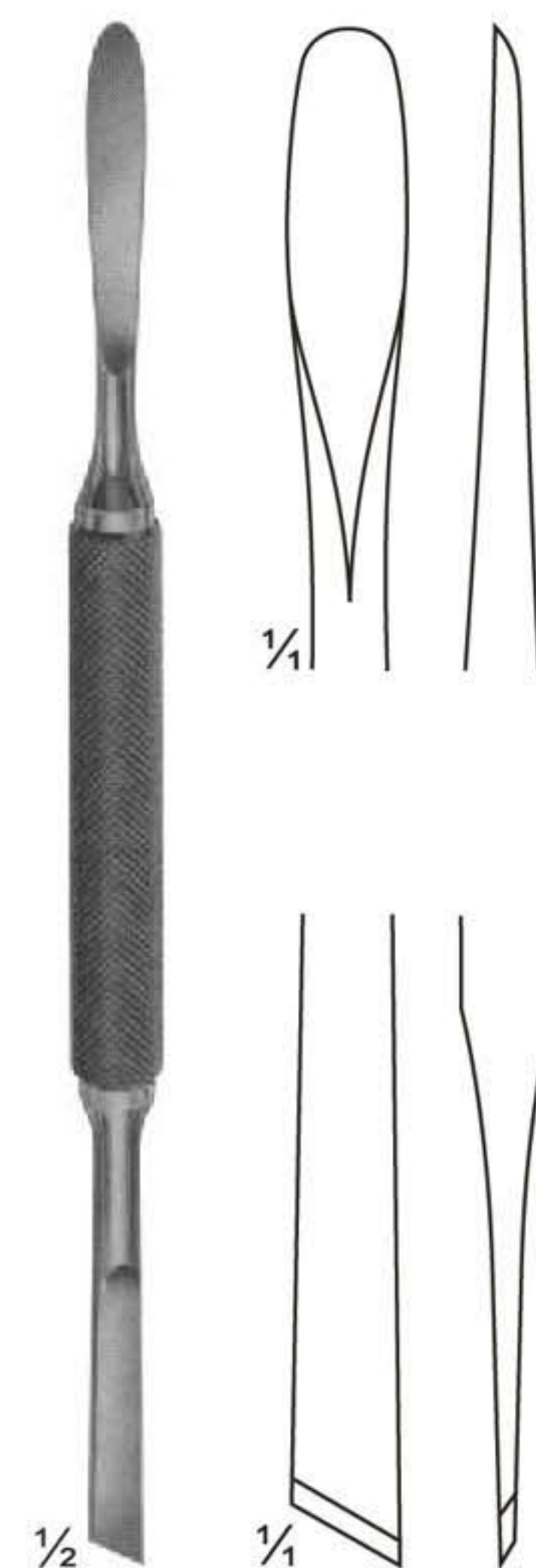

**20-159**  
MEAD  
sharp/sharp  
165 mm

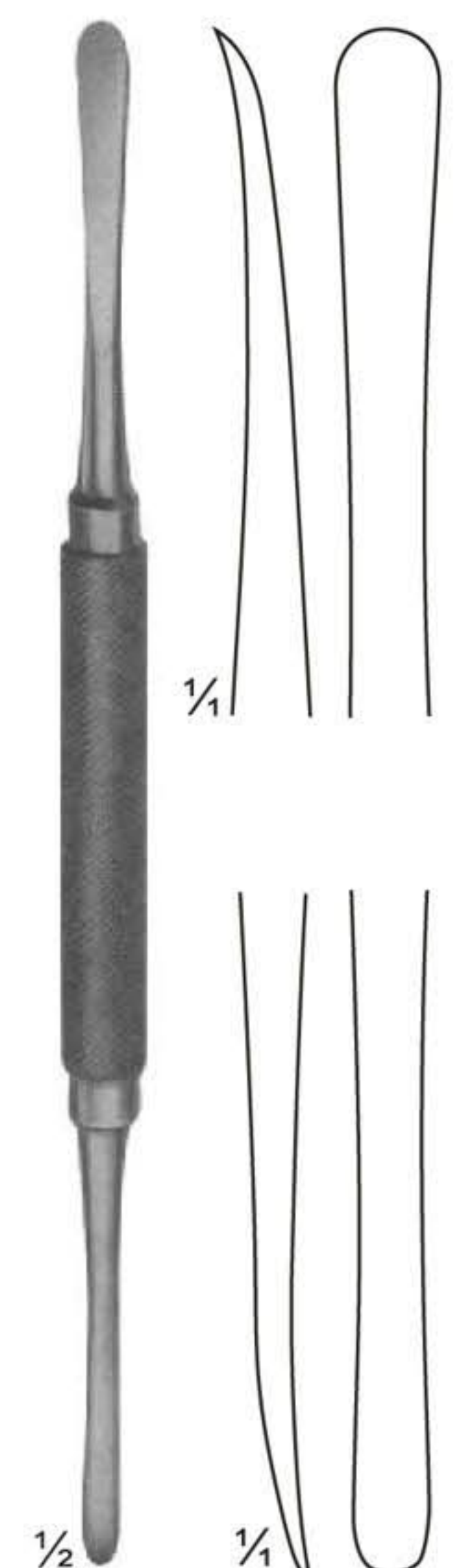

**20-160**  
MOLT  
sharp/sharp  
180 mm



# Raspatories

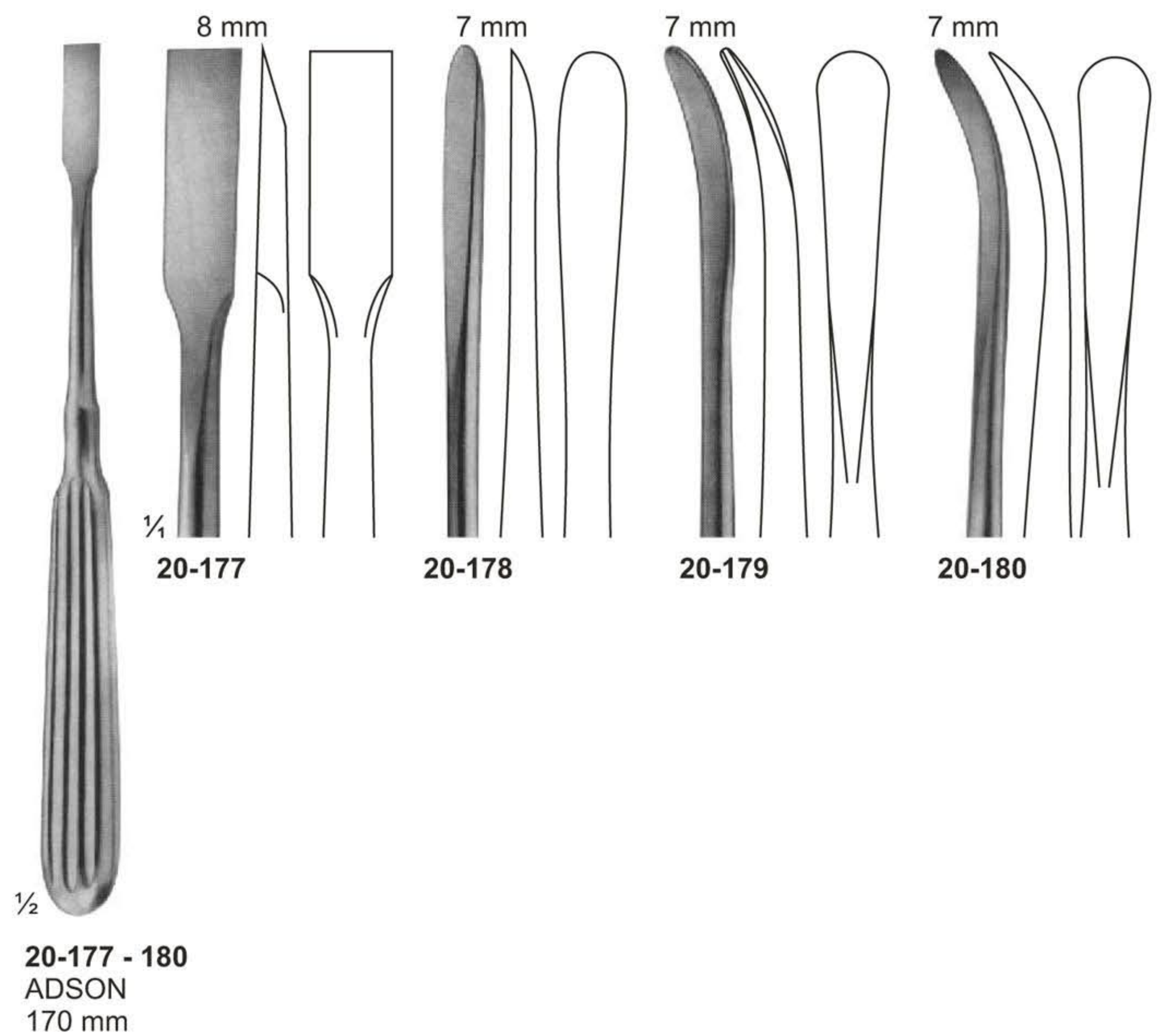
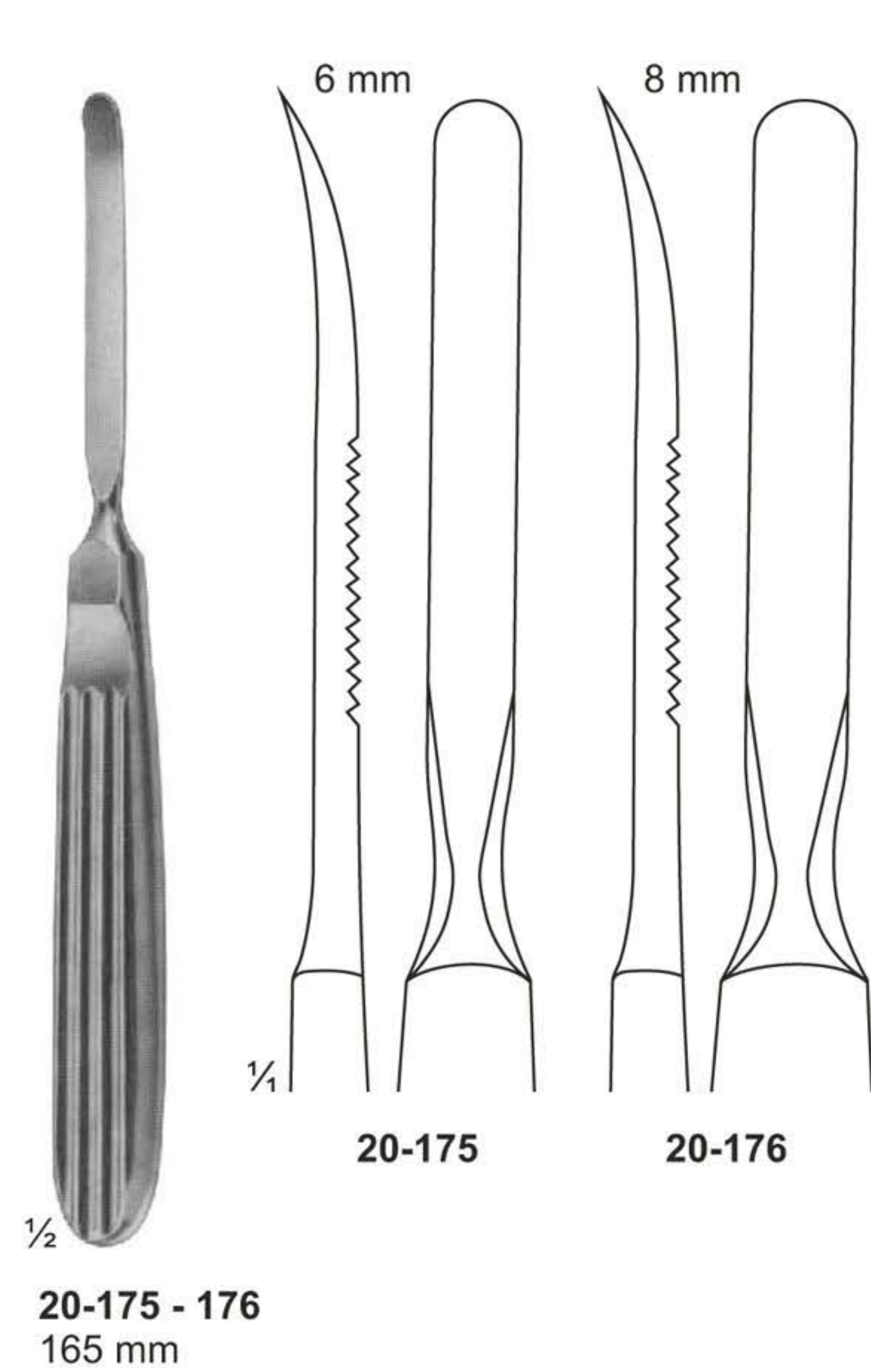
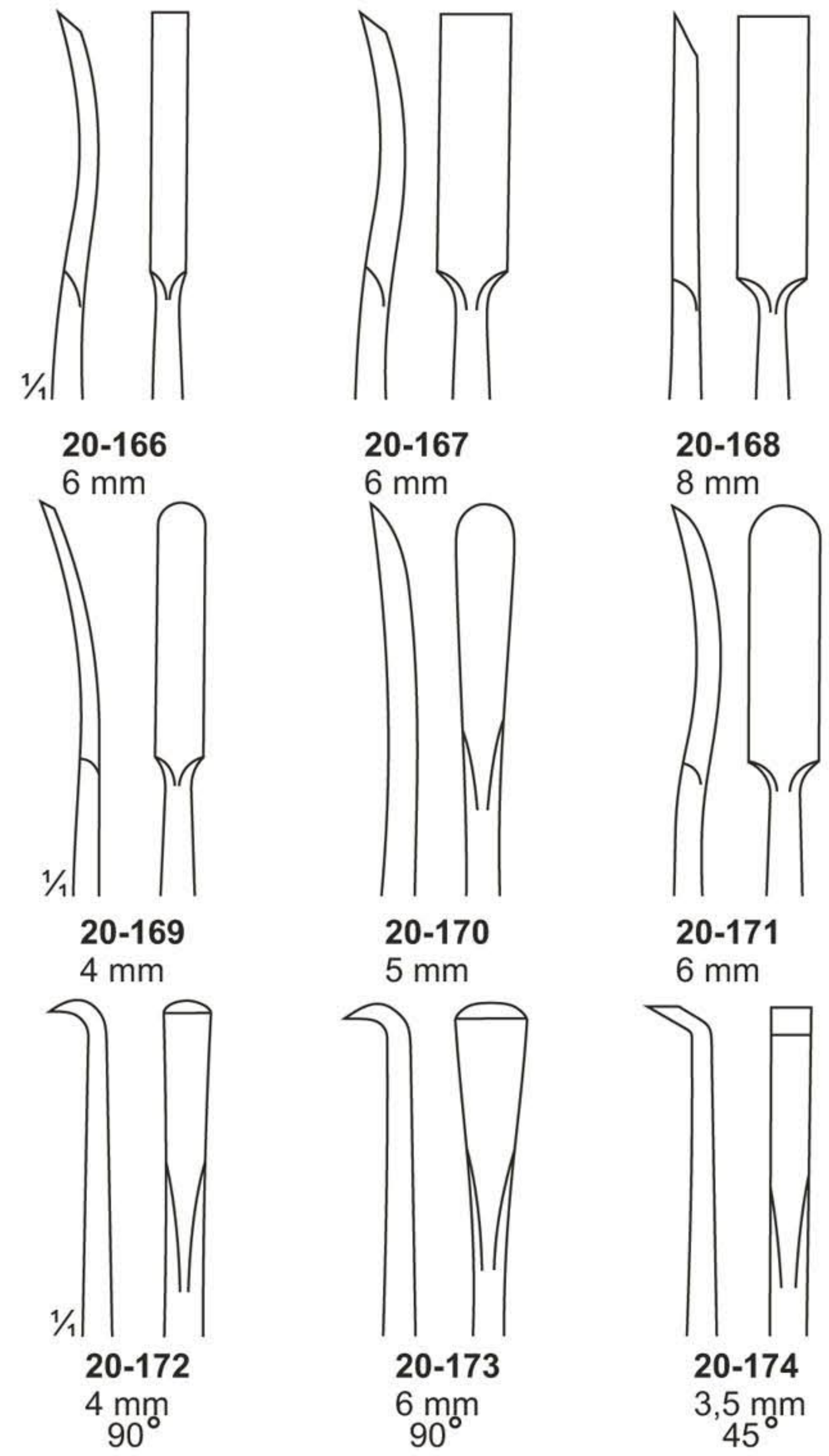
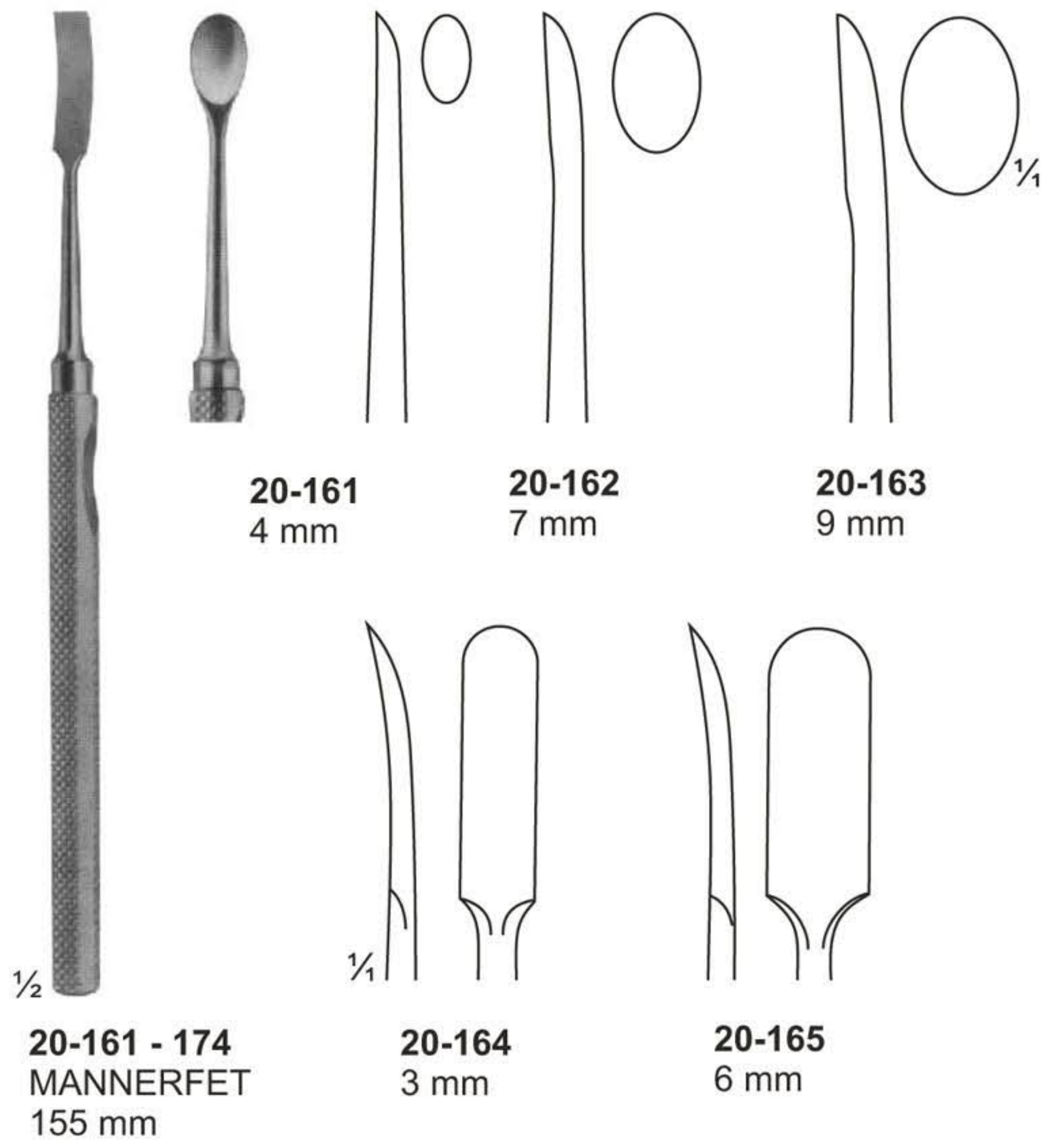



# Raspatories

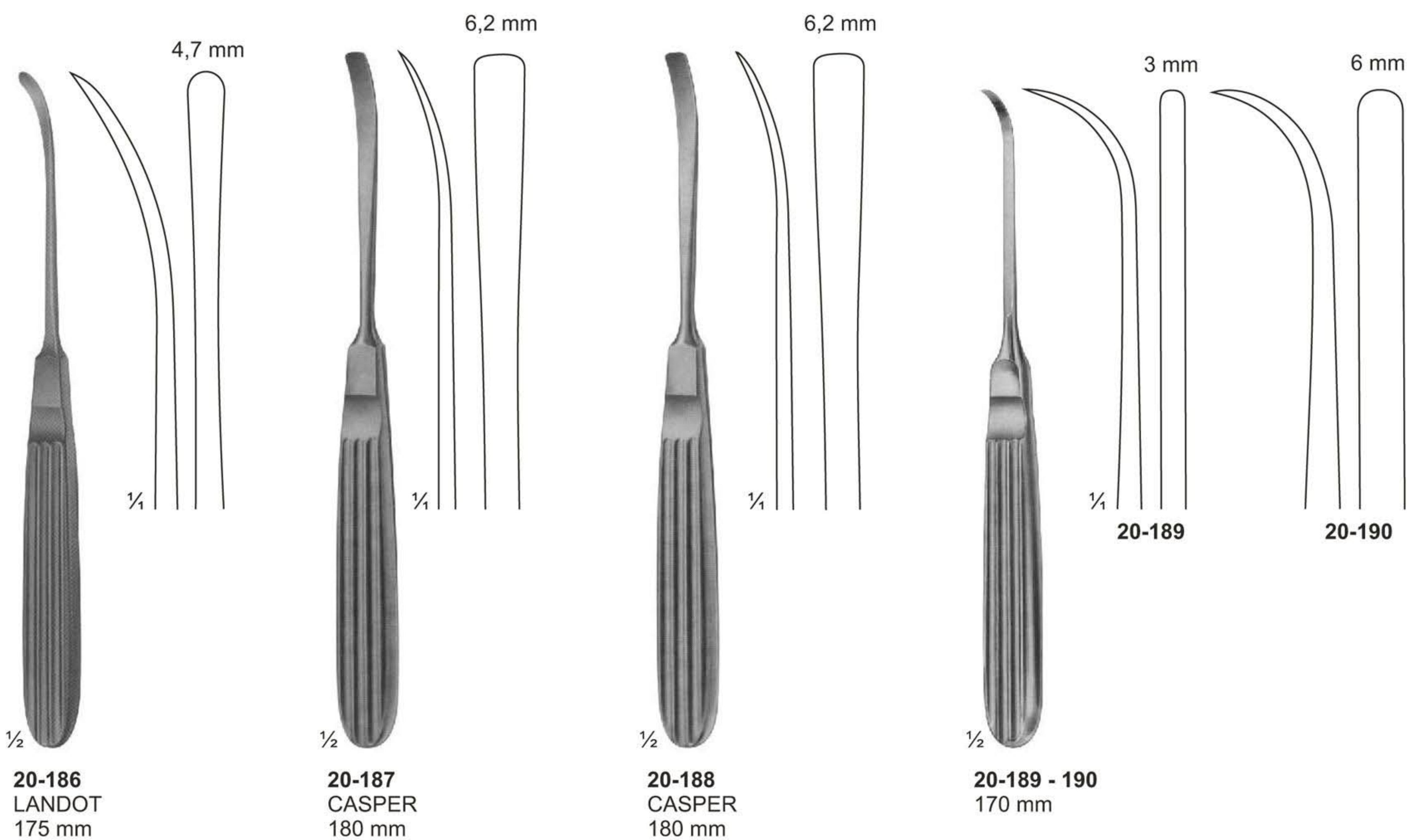
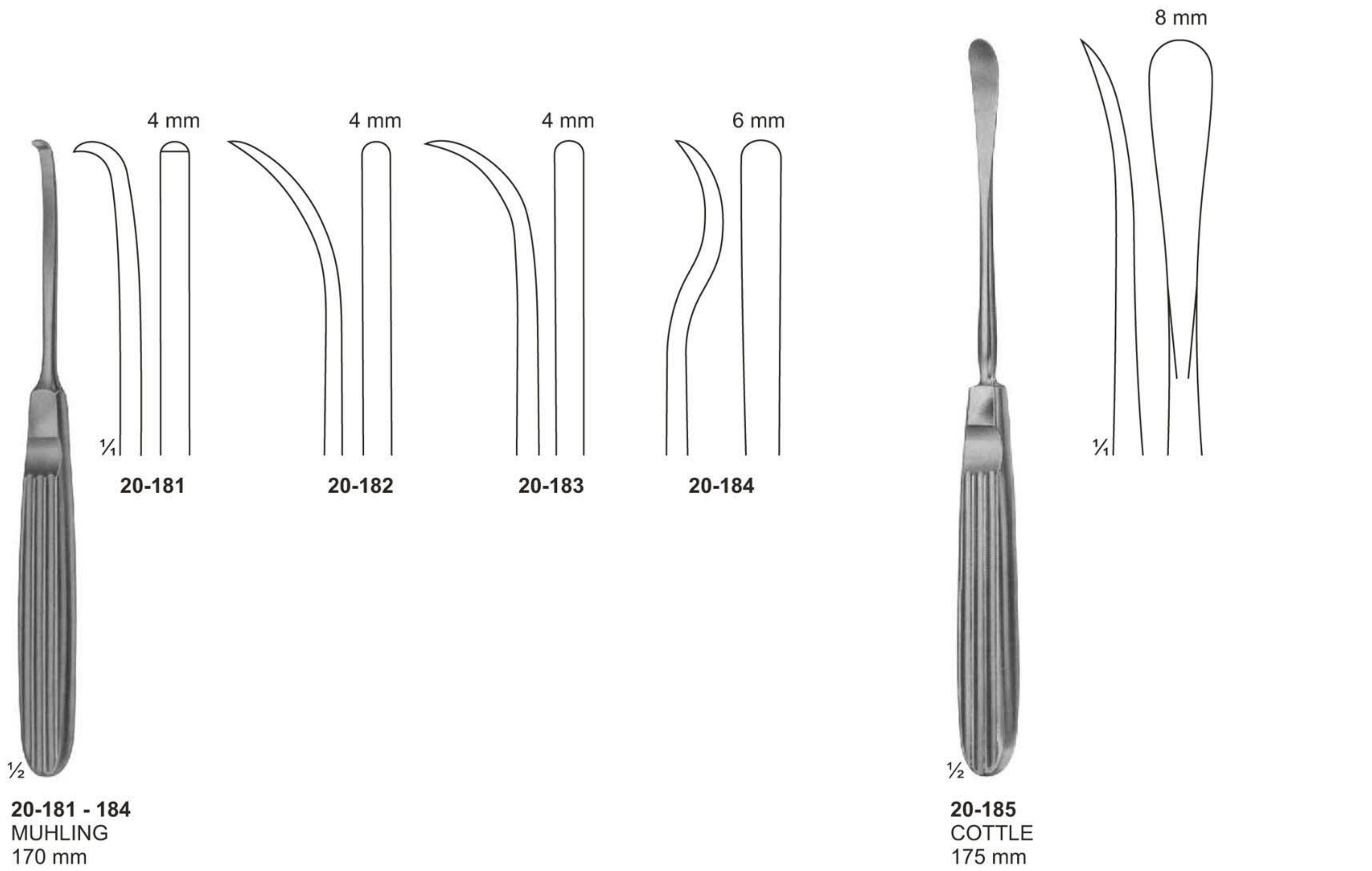



# Raspatories

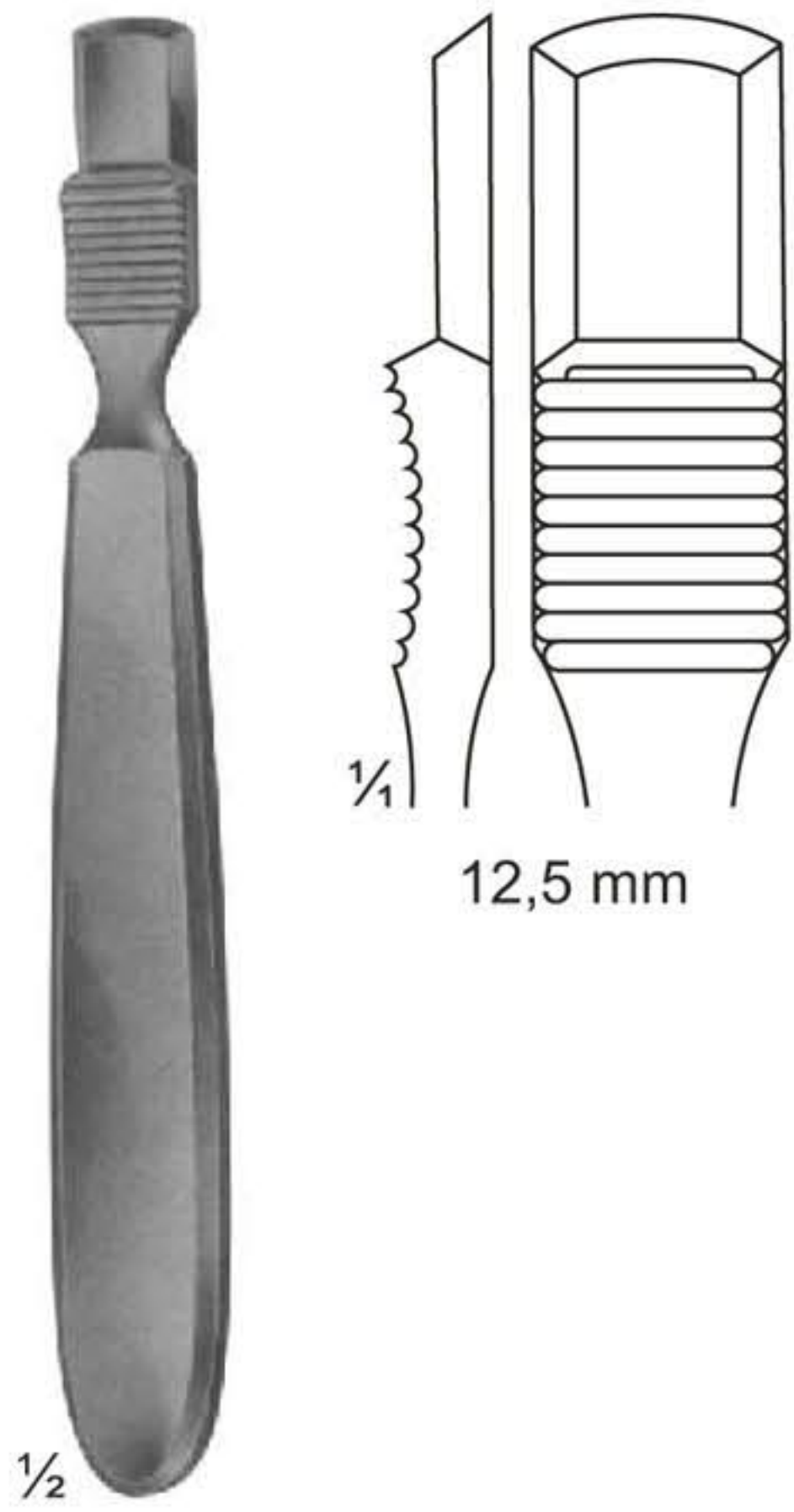

**20-191**  
FARABEU  
140 mm

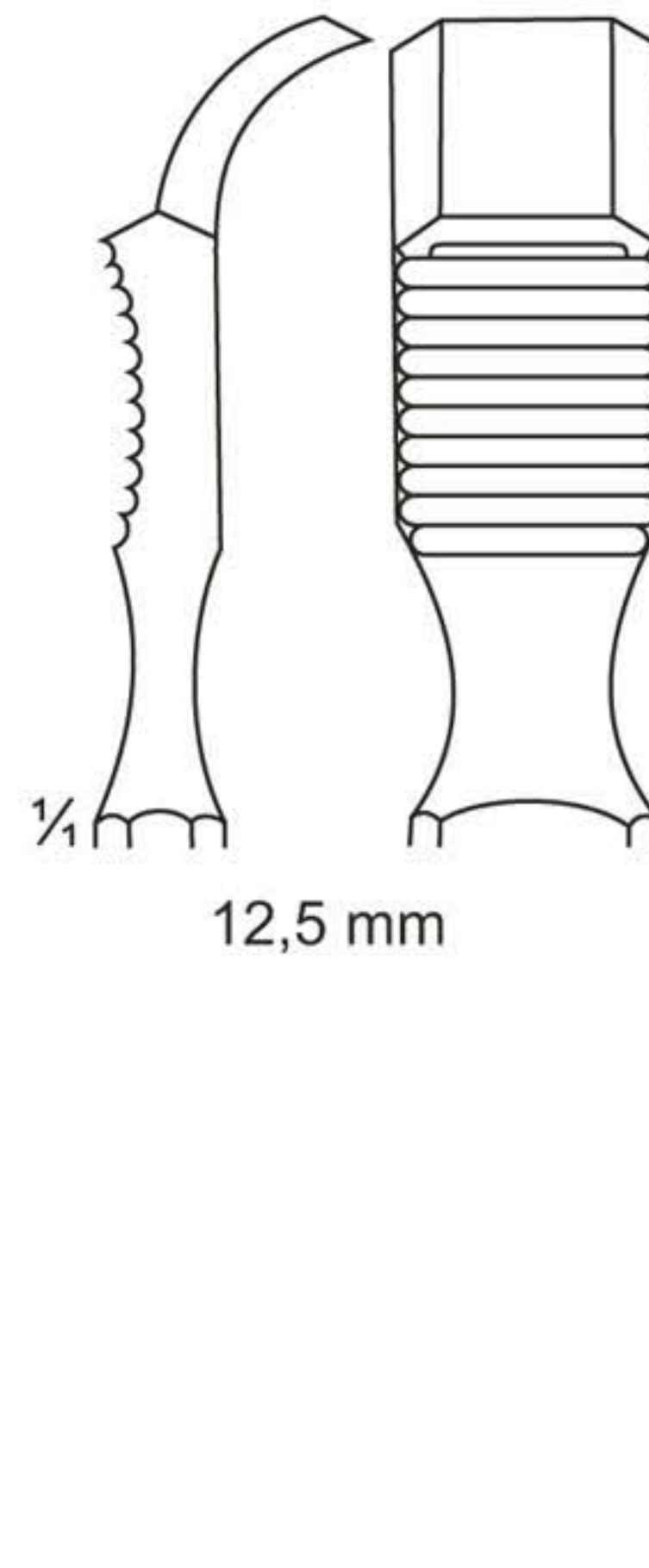

**20-192**  
FARABEU  
140 mm

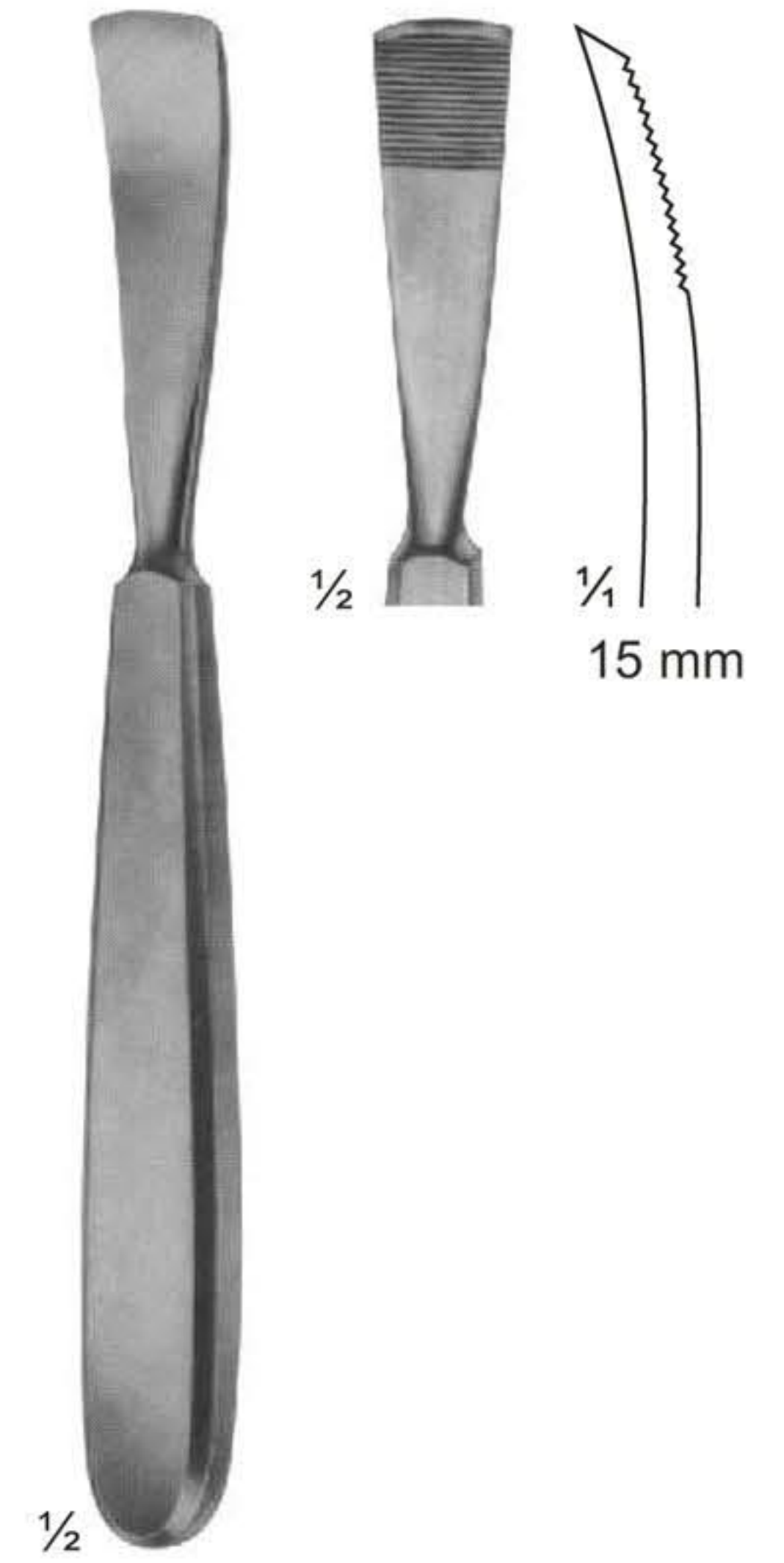

**20-193**  
JANSEN  
165 mm

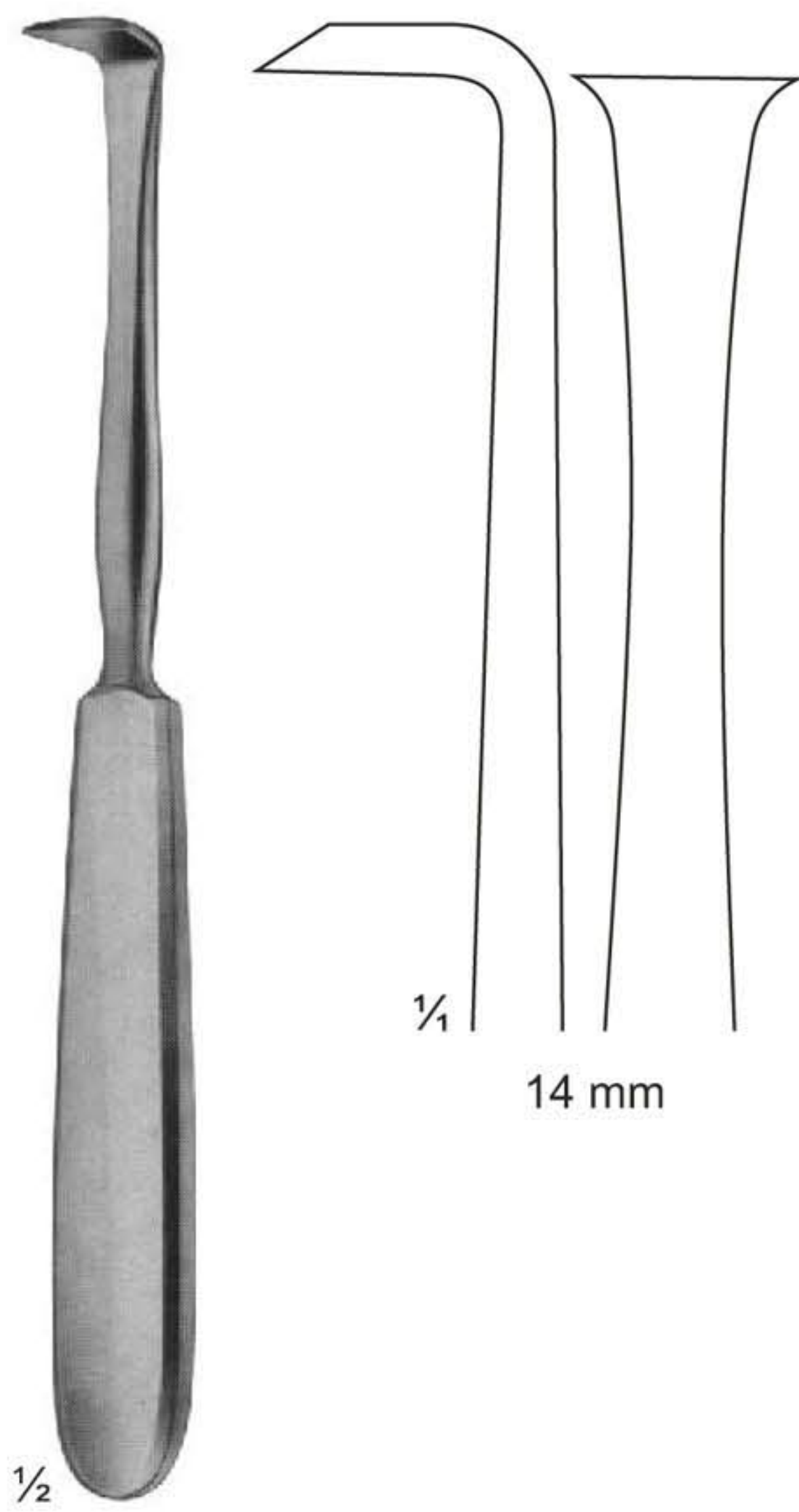

**20-194**  
LANGENBACK  
180 mm

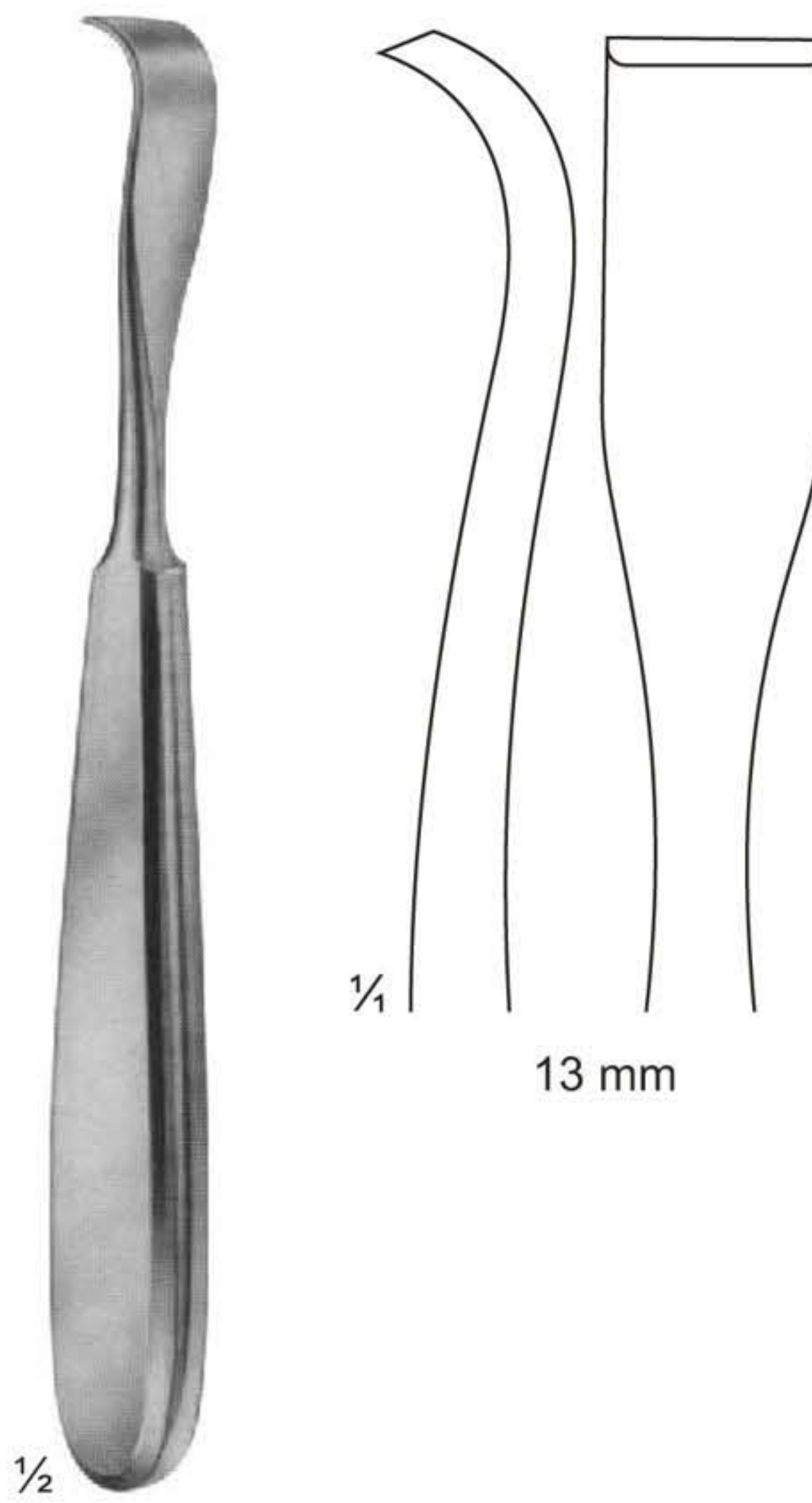

**20-195**  
SCHNEIDER  
175 mm

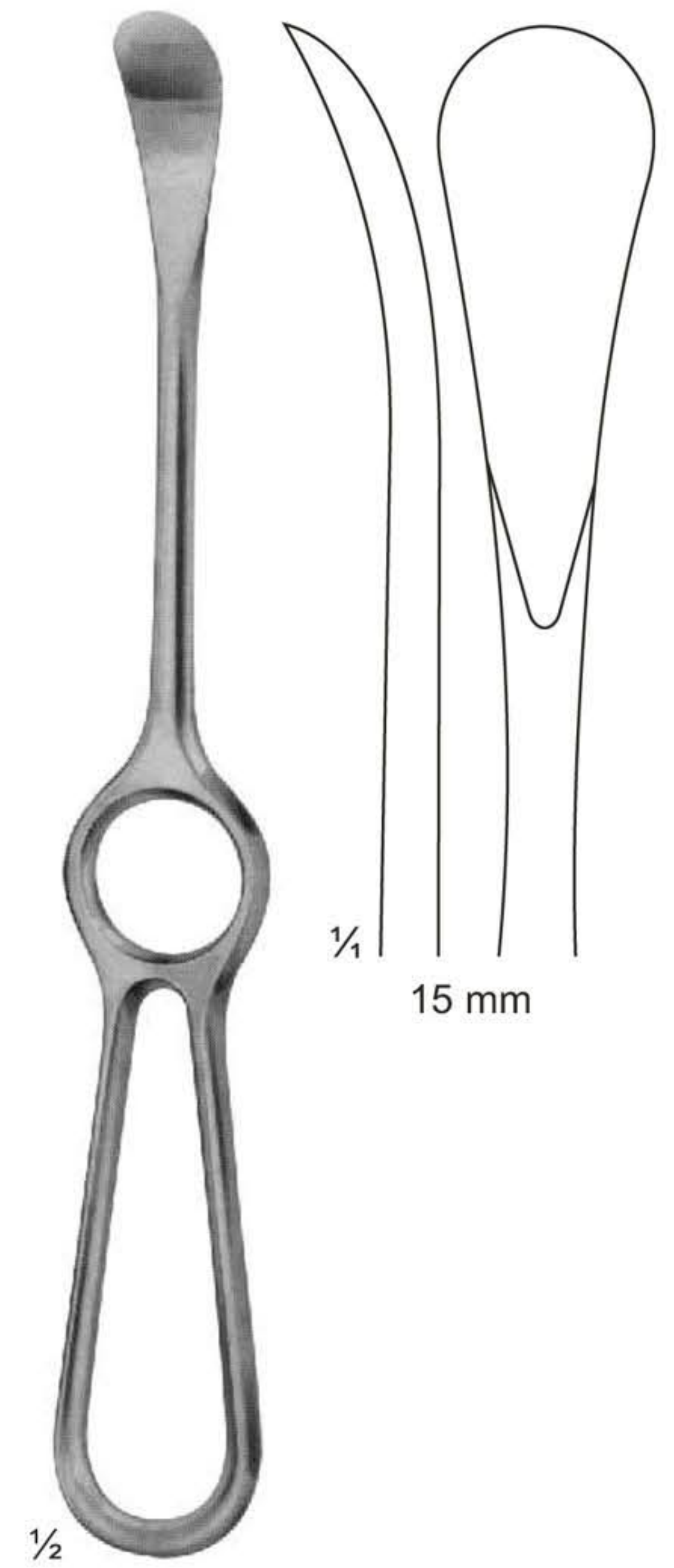

**20-196**  
SEDILLOT  
215 mm



# Raspatories

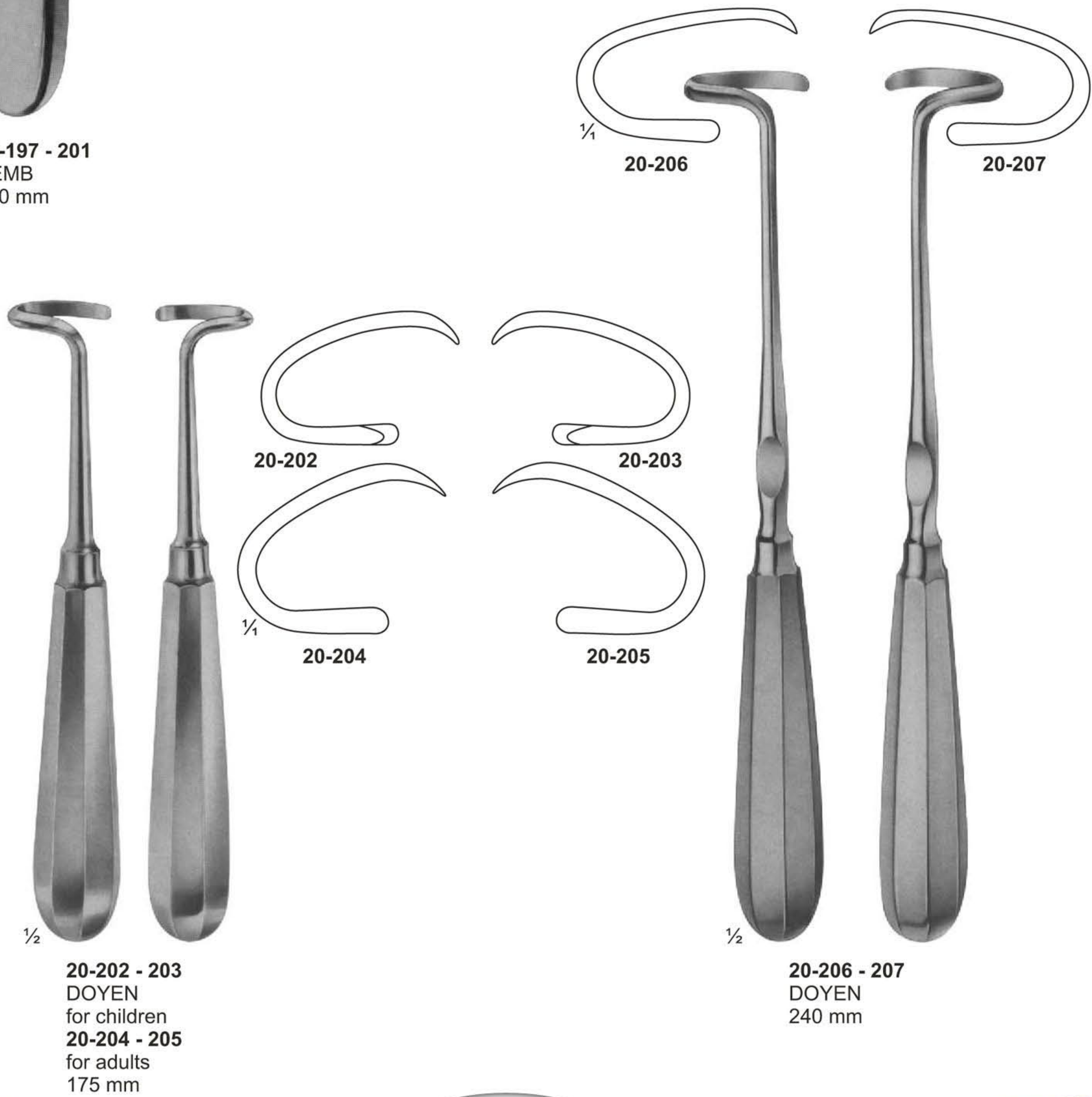
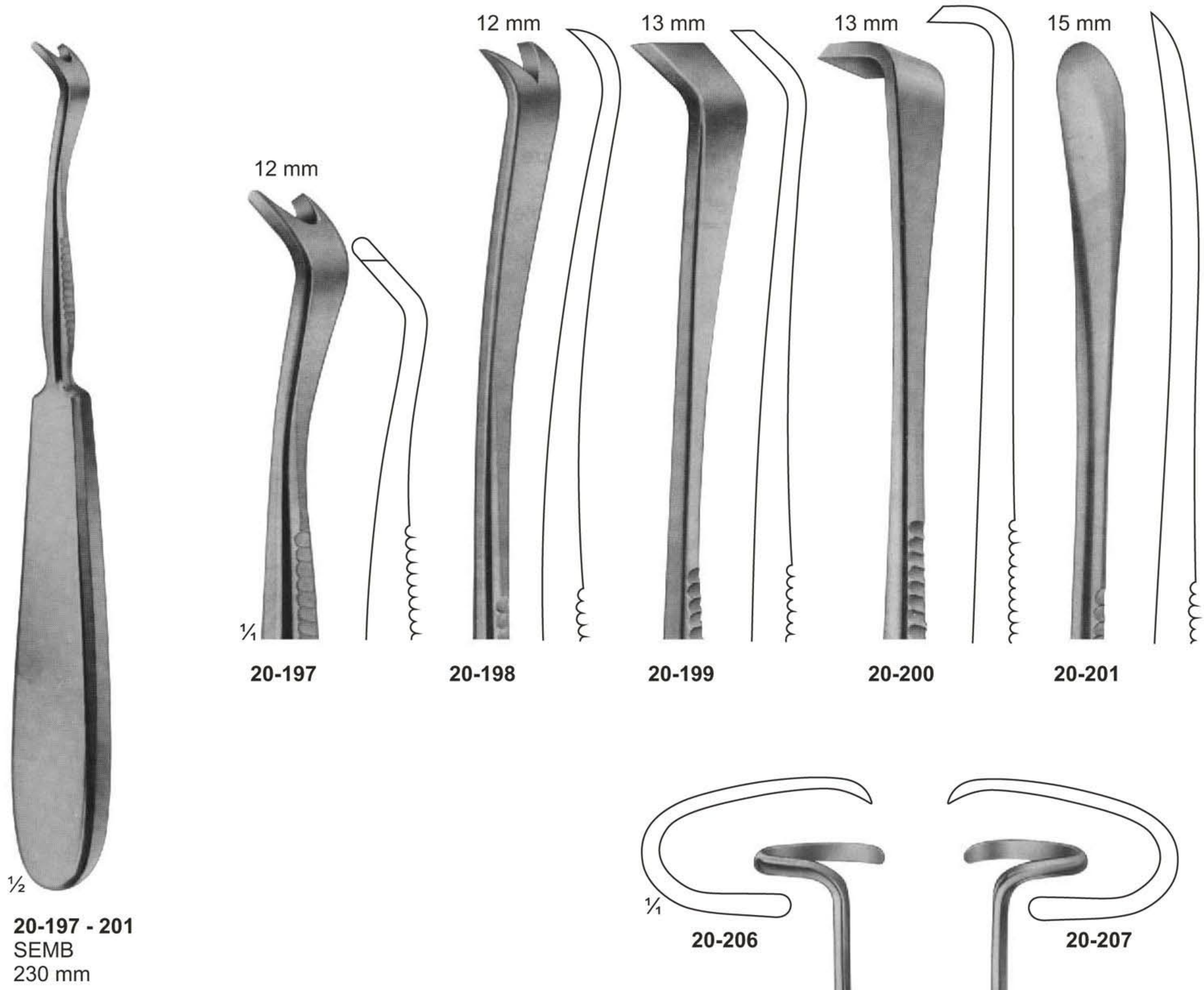



Raspatories with HARTPRESS-handle

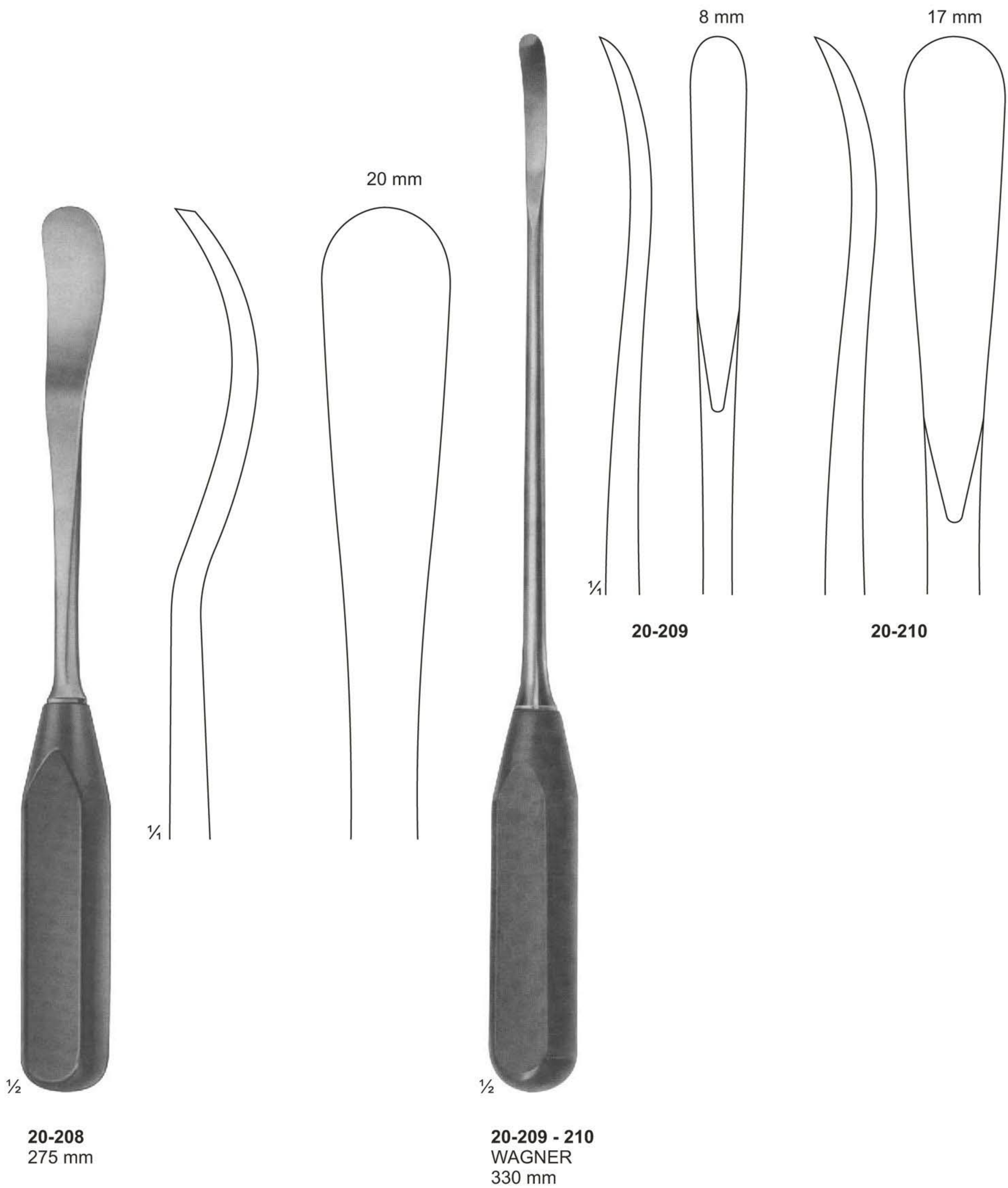



# Bone File and Rasps

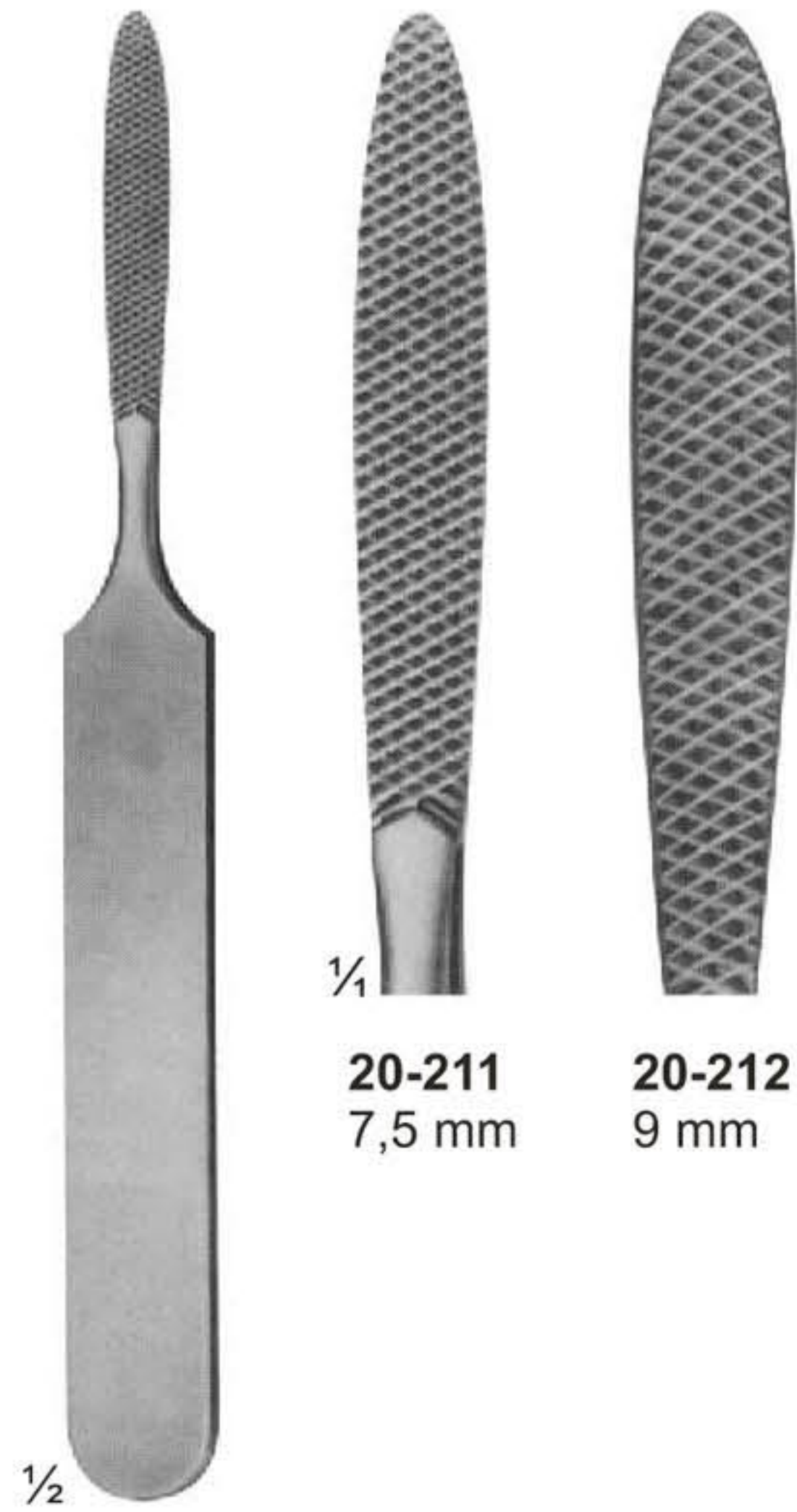

**20-211**  
7,5 mm

**20-212**  
9 mm

**20-213**  
8 mm

**20-214**  
8 mm  
coarse, teeth  
175 mm

**20-211**  
JOSEPH  
fine, chequered

**20-212**  
coarse, chequered  
165 mm

**20-213**  
LEWIS  
fine, teeth



**20-215**  
9 mm

**20-216**  
9 mm

**20-217**  
9 mm

**20-218**  
6,5 mm

**20-215**  
MALTZ  
down stroke  
180 mm

**20-216**  
AUFRICHT  
up stroke  
**20-217**  
down stroke  
220 mm

**20-218**  
GALLAHER  
190 mm



**Bone File and Rasps**

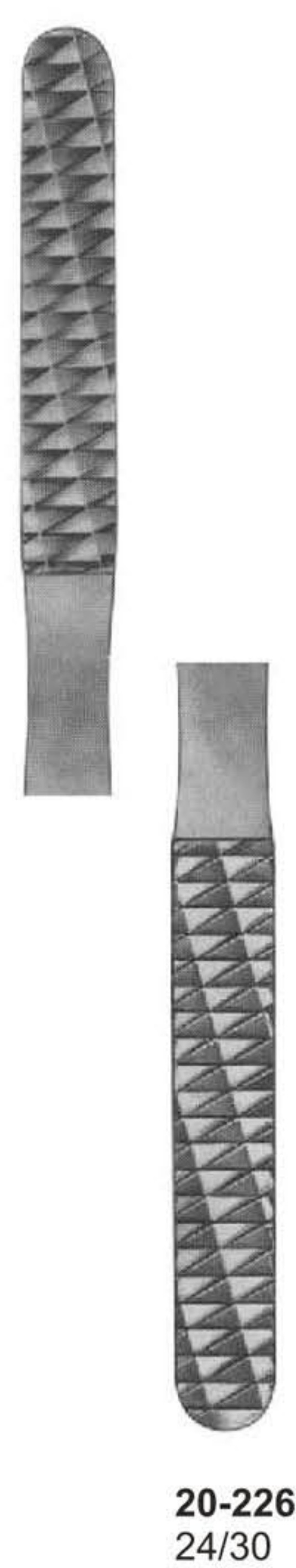
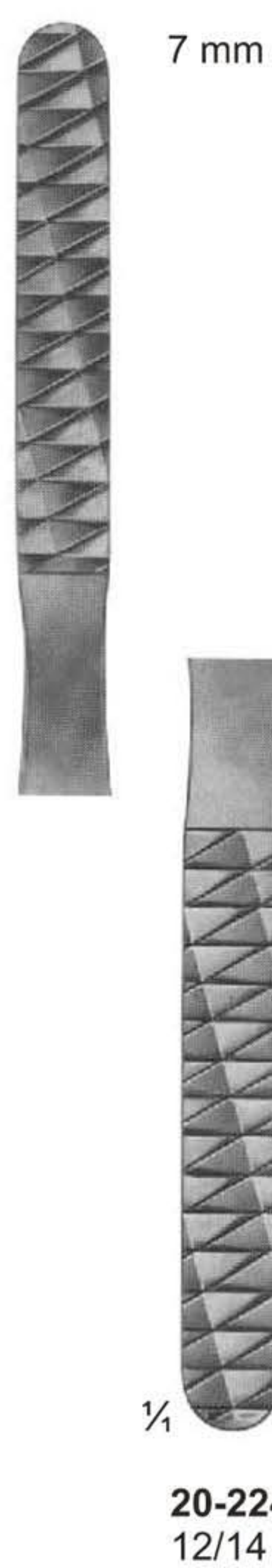
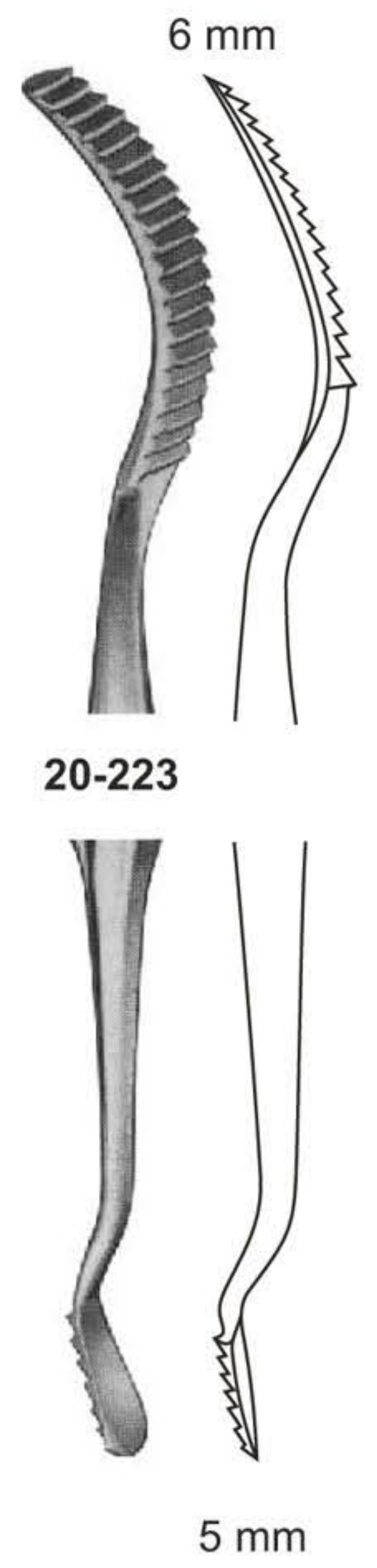
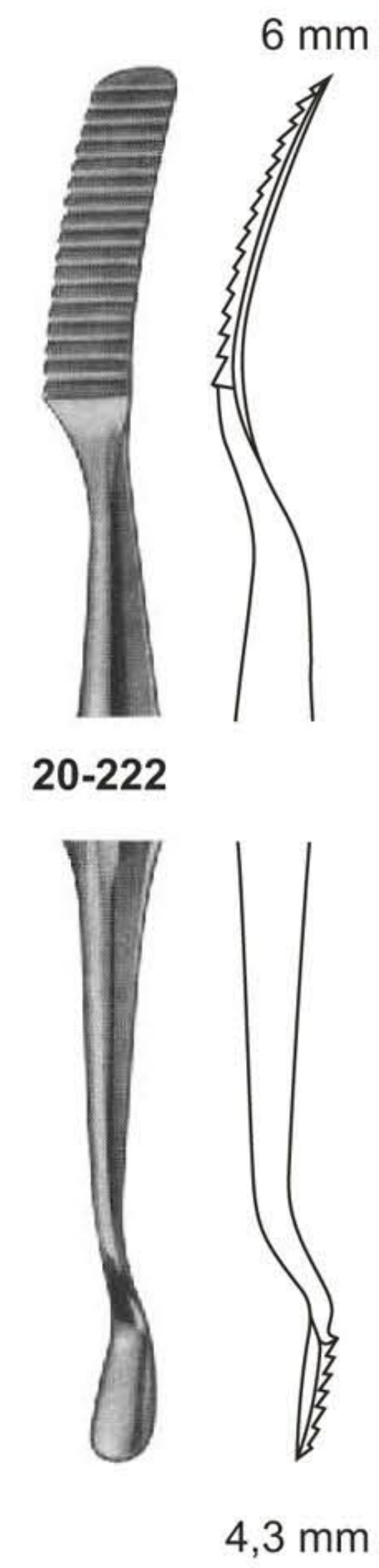
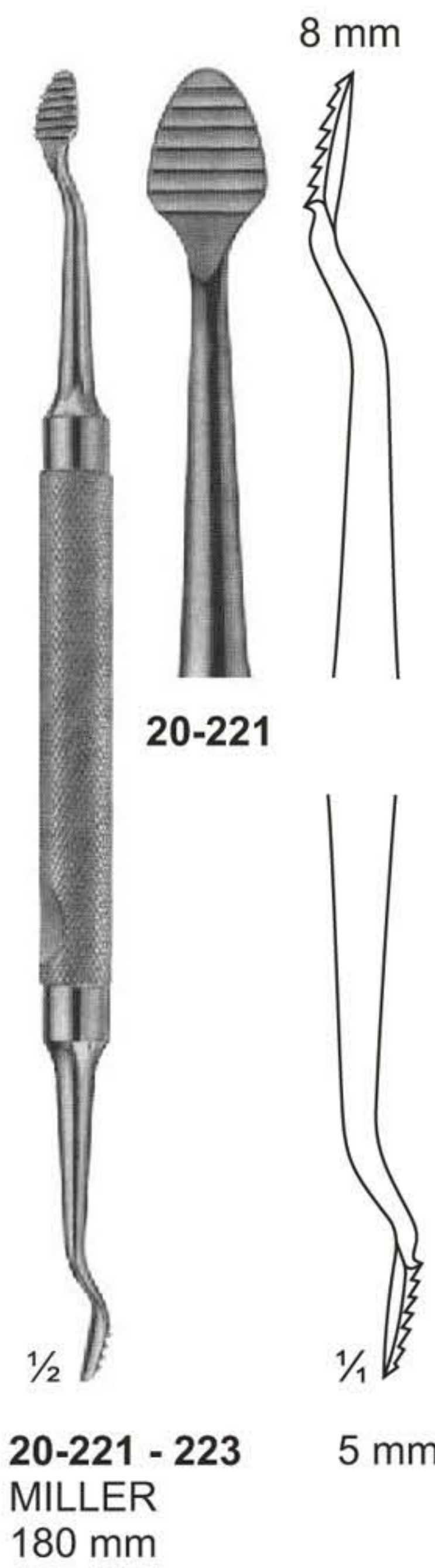
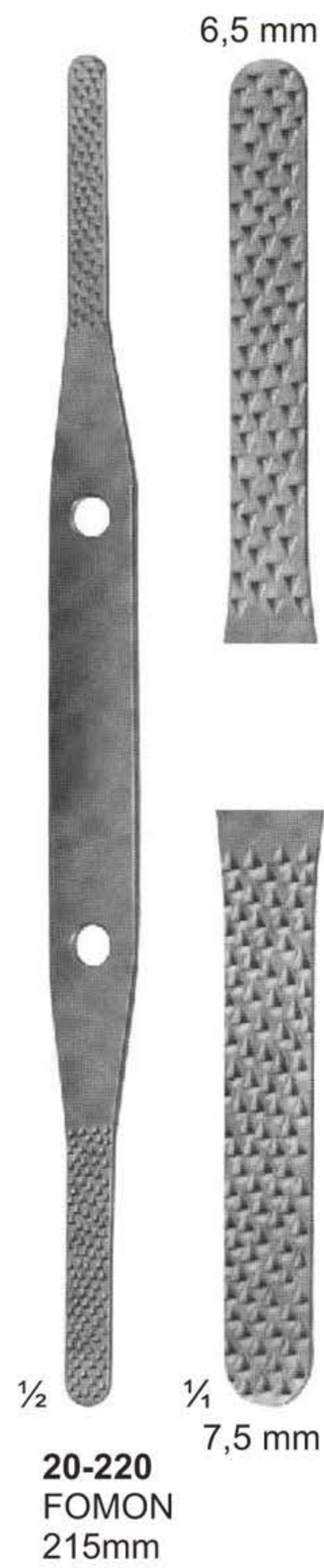
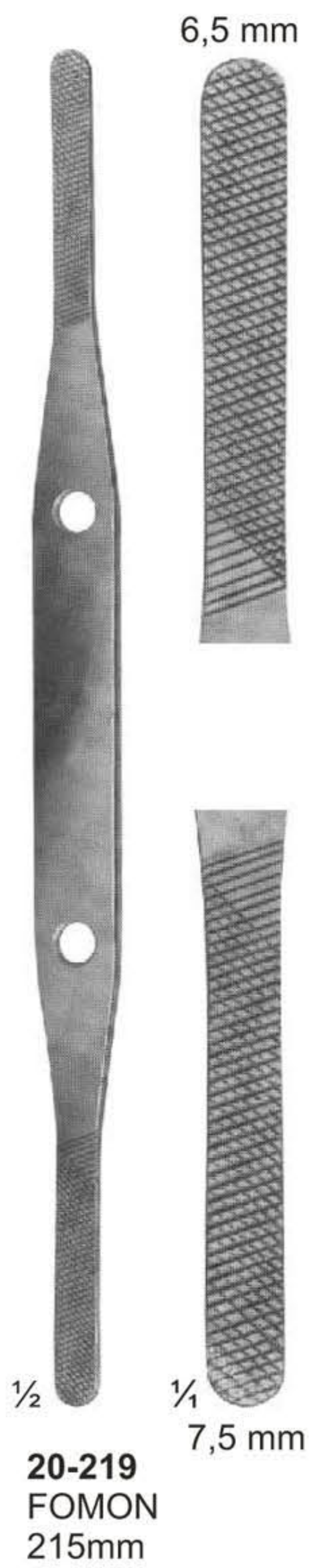



# Bone File and Rasps

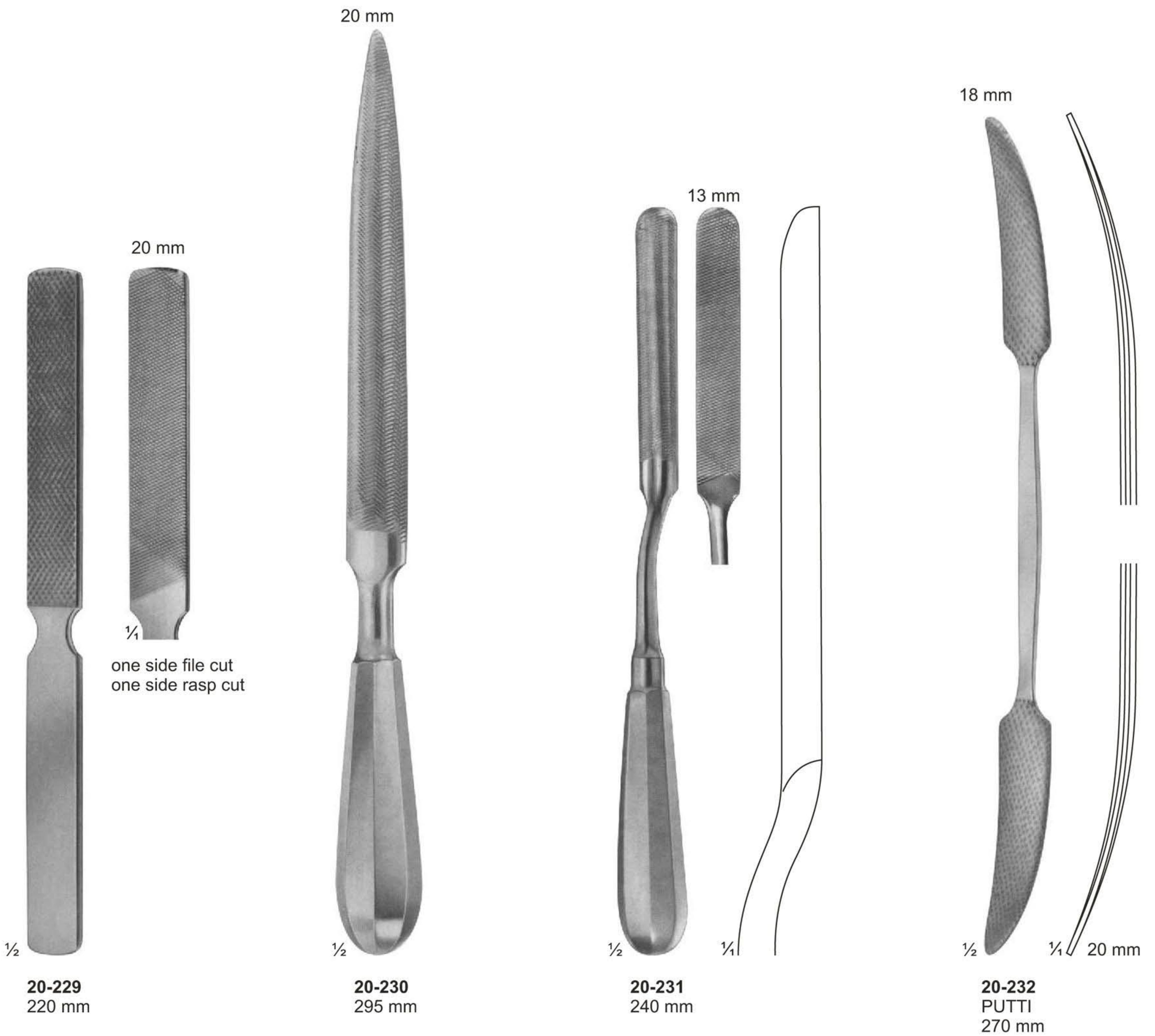



**Bone Curettes**

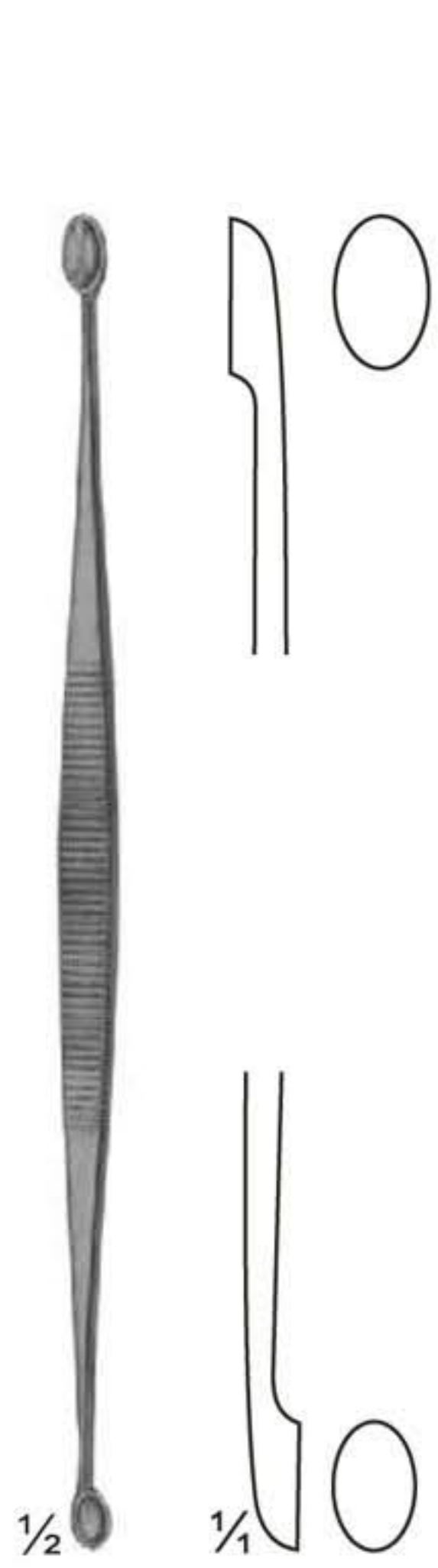

**20-233**  
JACOBSON  
140 mm

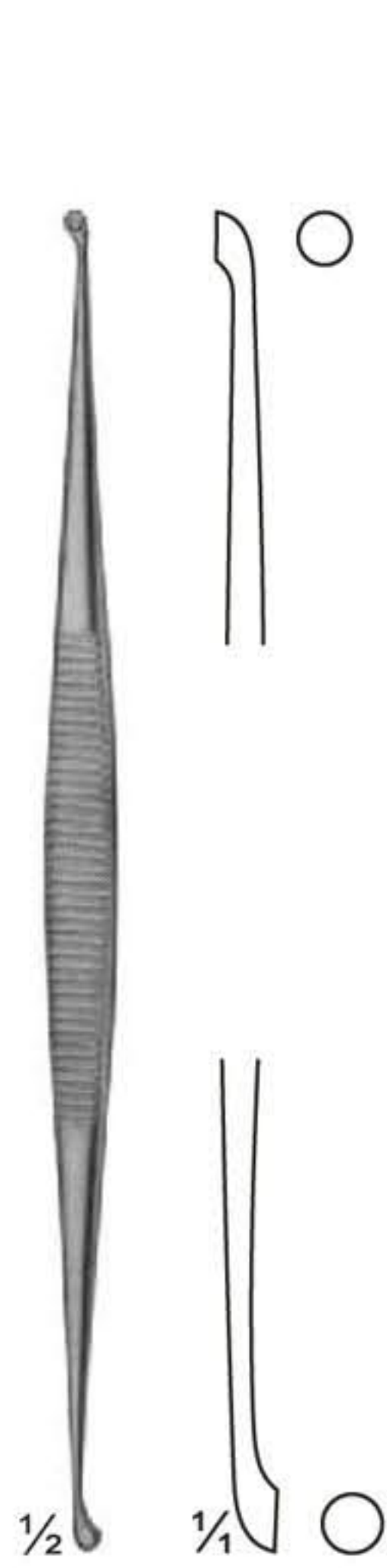

**20-234**  
MARTINI  
140 mm

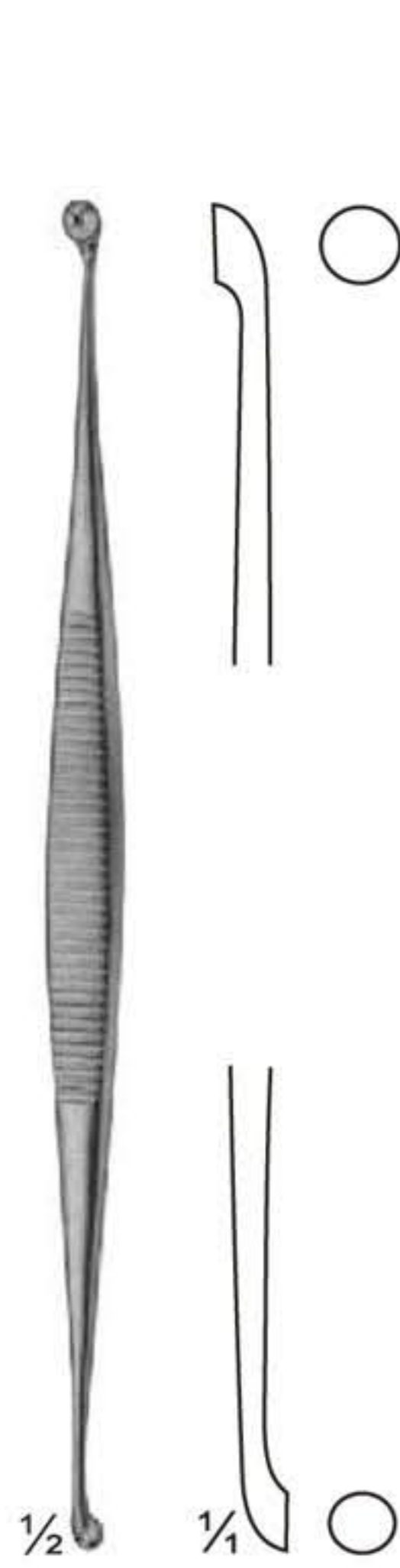

**20-235**  
MARTINI  
140 mm



**20-236**  
WILLIGER  
145 mm



**20-237**  
JANSEN  
160 mm



**20-238**  
BARTH  
180 mm

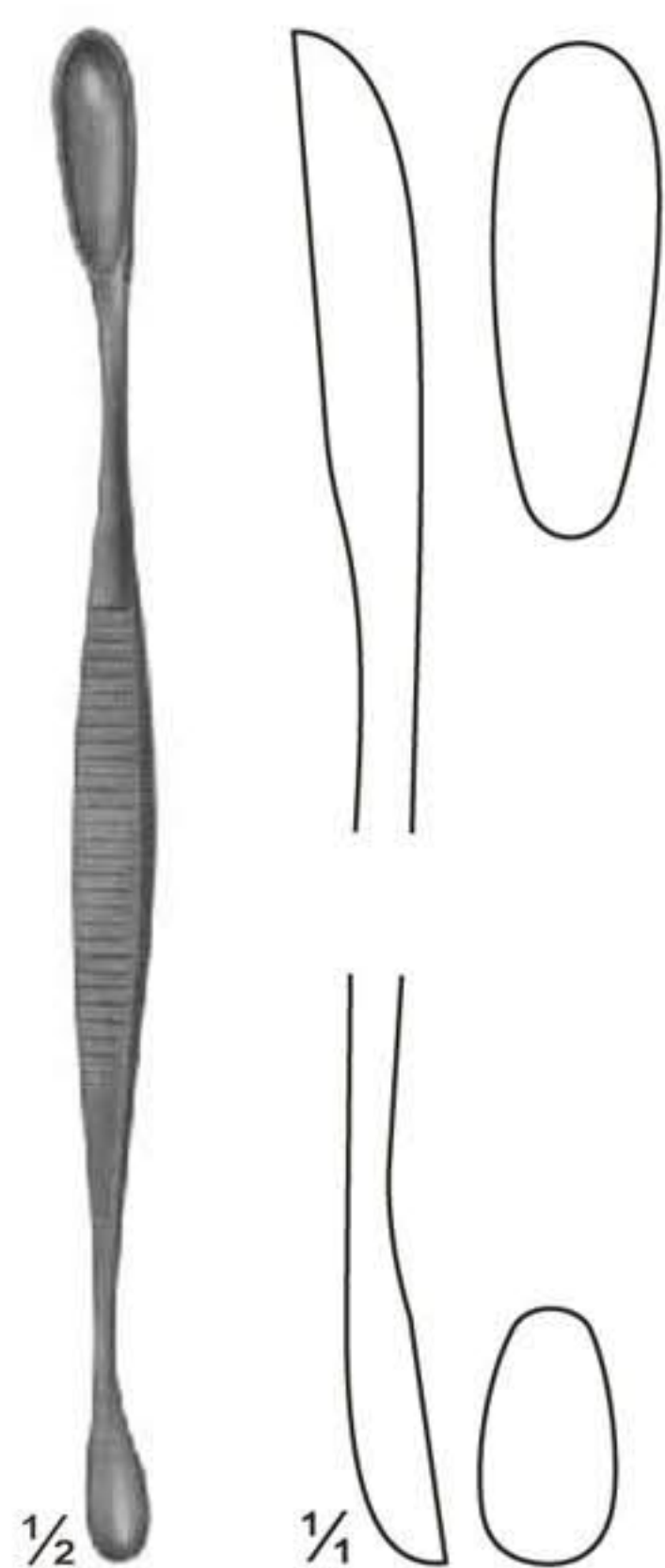

**20-239**  
VOLKMANN  
130 mm

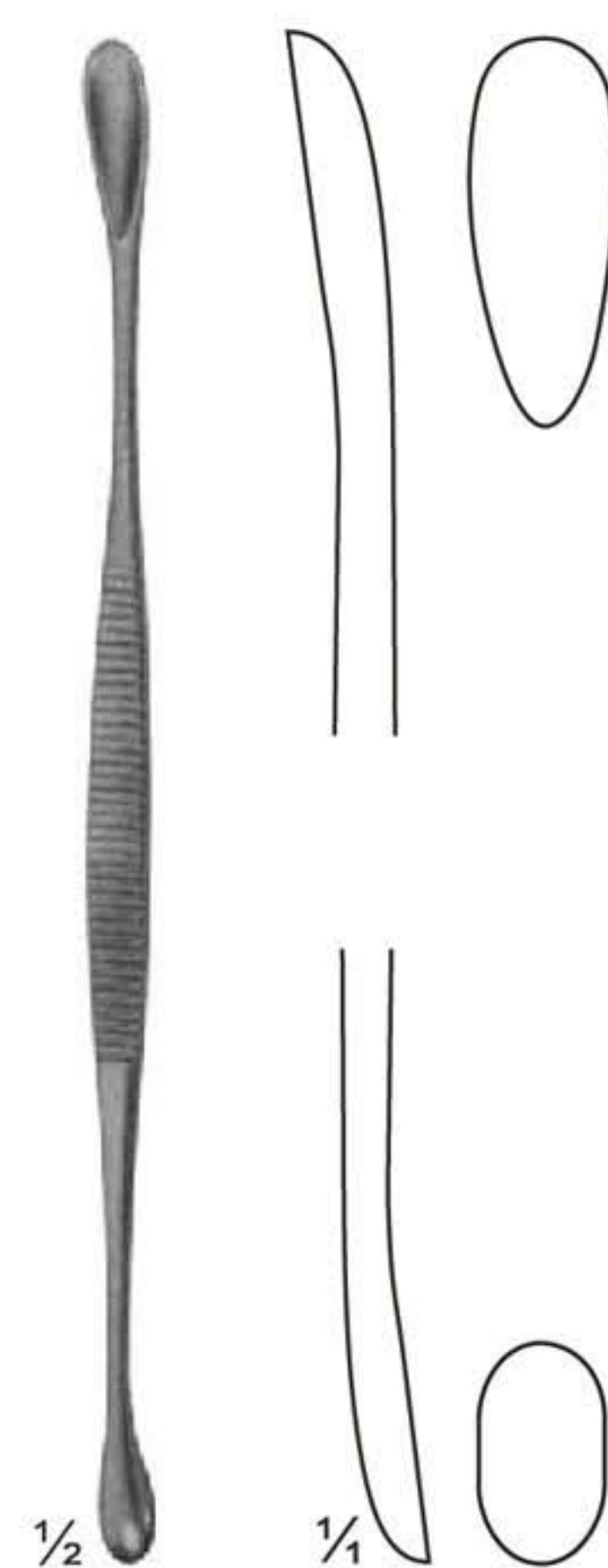

**20-240**  
VOLKMANN  
145 mm

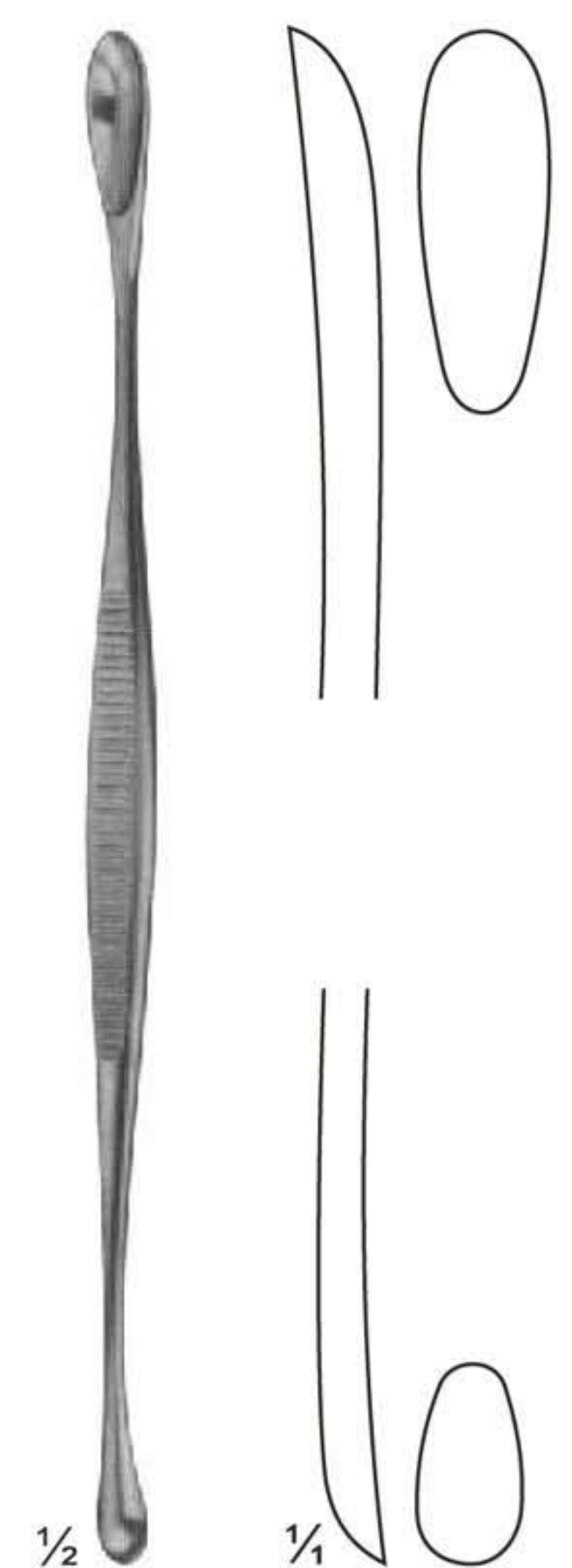

**20-241**  
VOLKMANN  
170 mm



**Bone Curettes**



**20-242**  
JANSEN  
160 mm

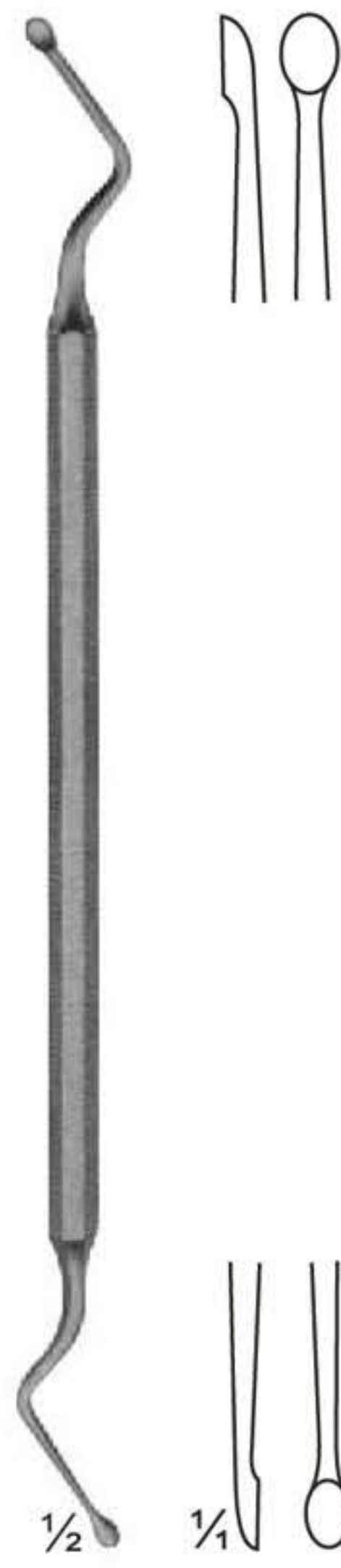

**20-243**  
HEMINGWAY  
170 mm

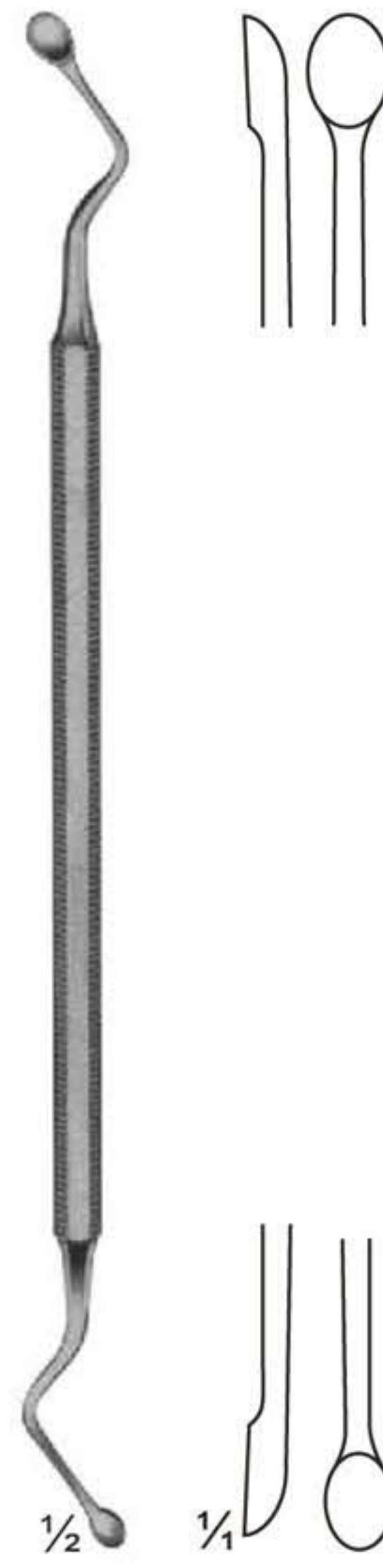

**20-244**  
HEMINGWAY  
175 mm

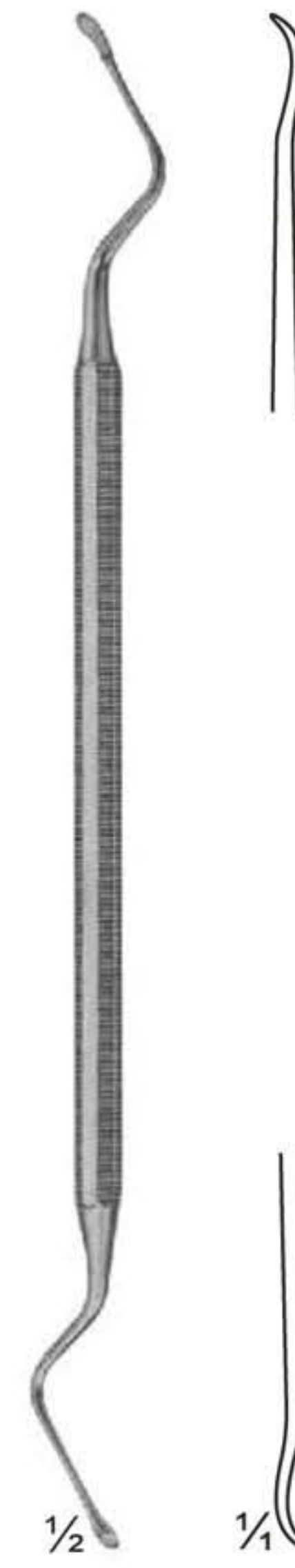

**20-245**  
LUCAS  
180 mm

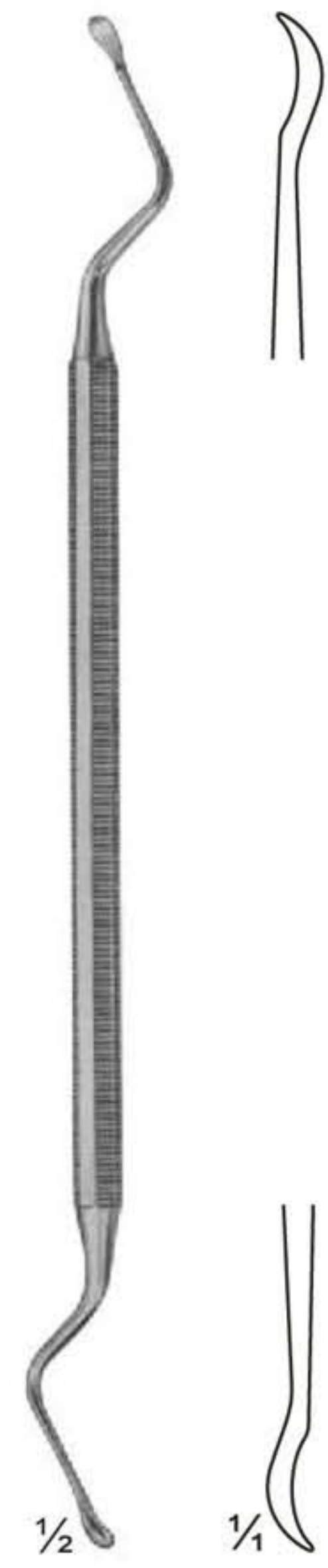

**20-246**  
LUCAS  
185 mm

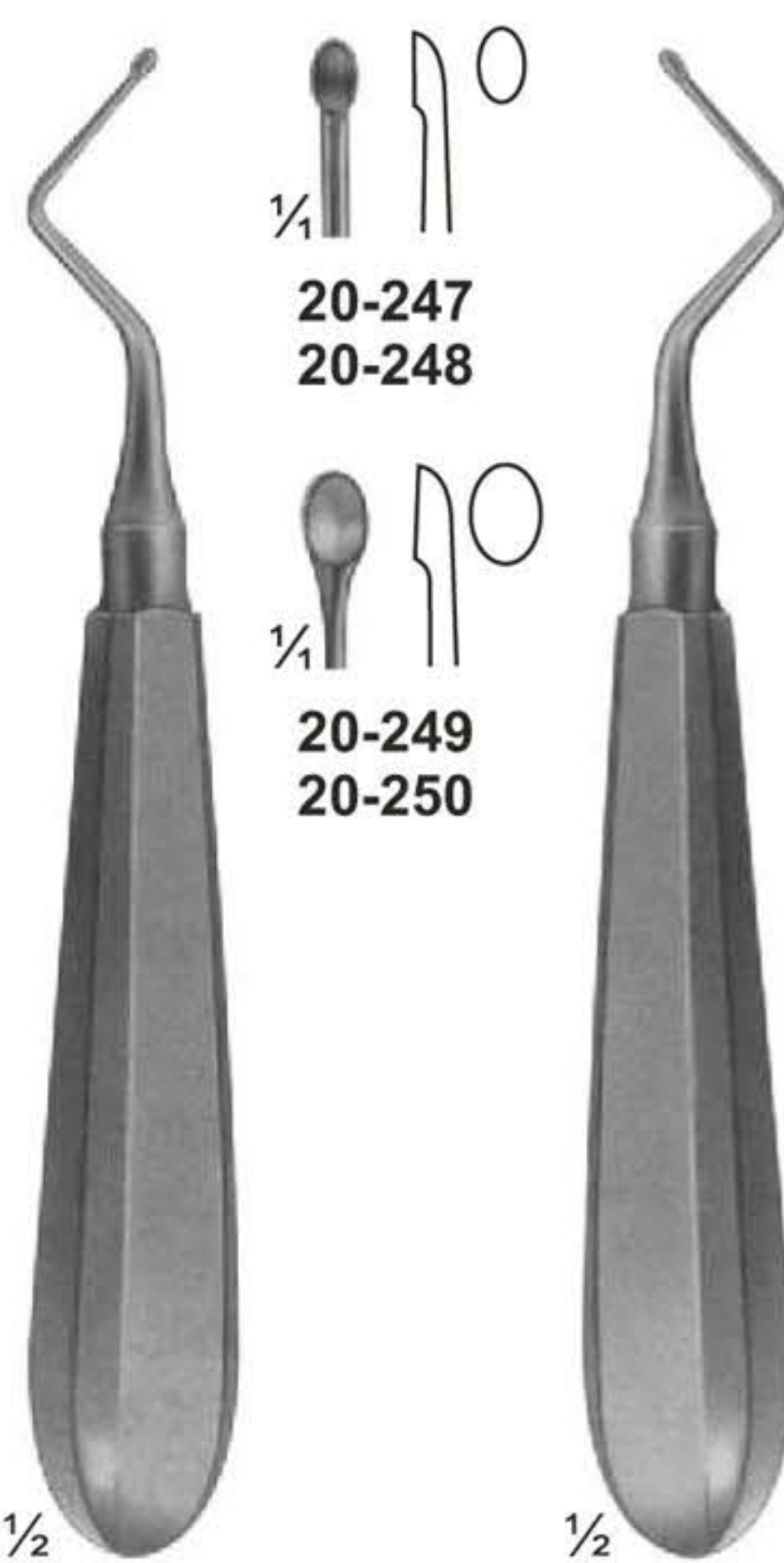

**20-247 - 248**  
KERPEL  
145 mm

**20-249 - 250**  
KERPEL  
145 mm

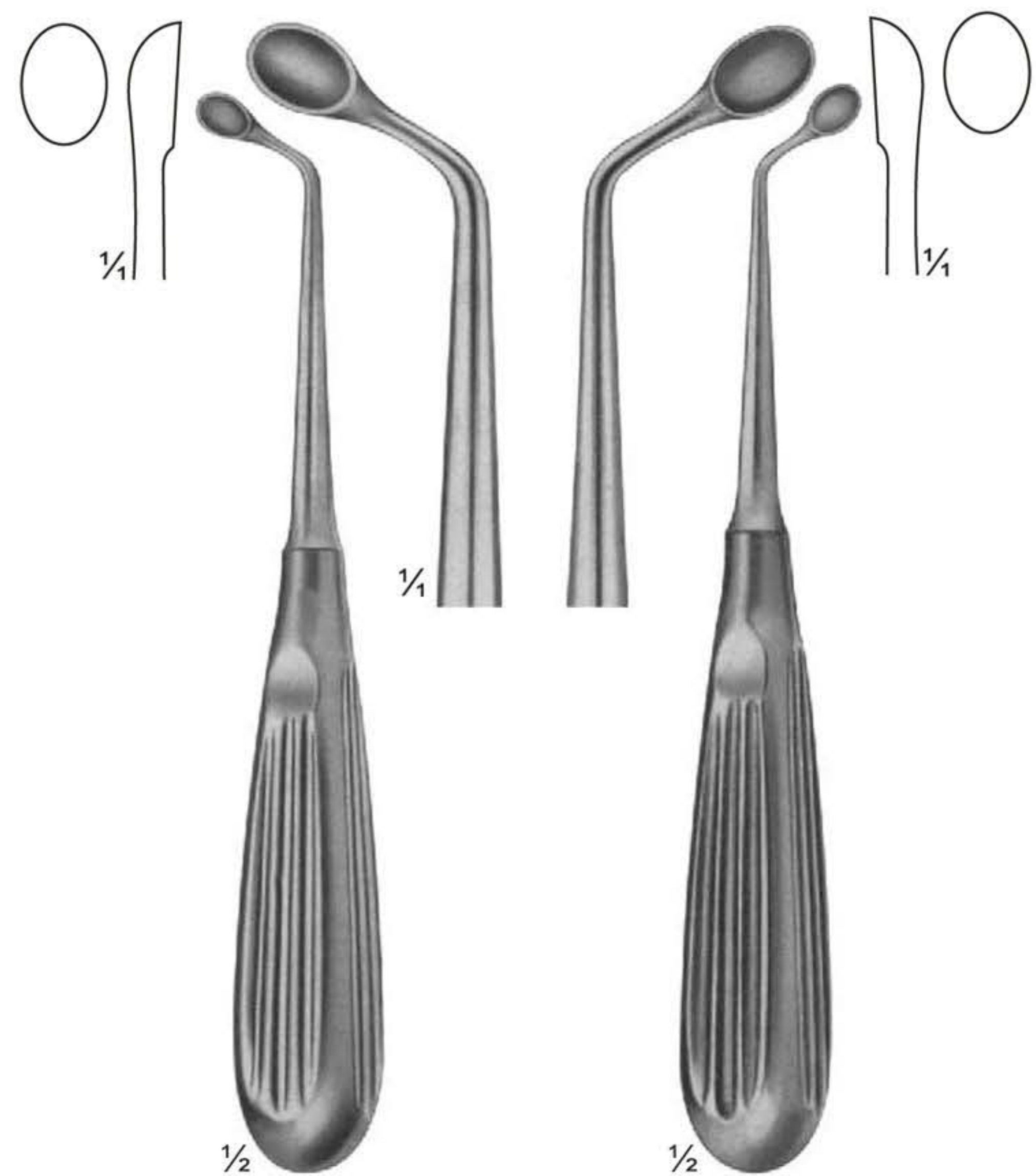

**20-251**  
UFFENORDE  
170 mm

**20-252**  
UFFENORDE  
170 mm



# Bone Currettes

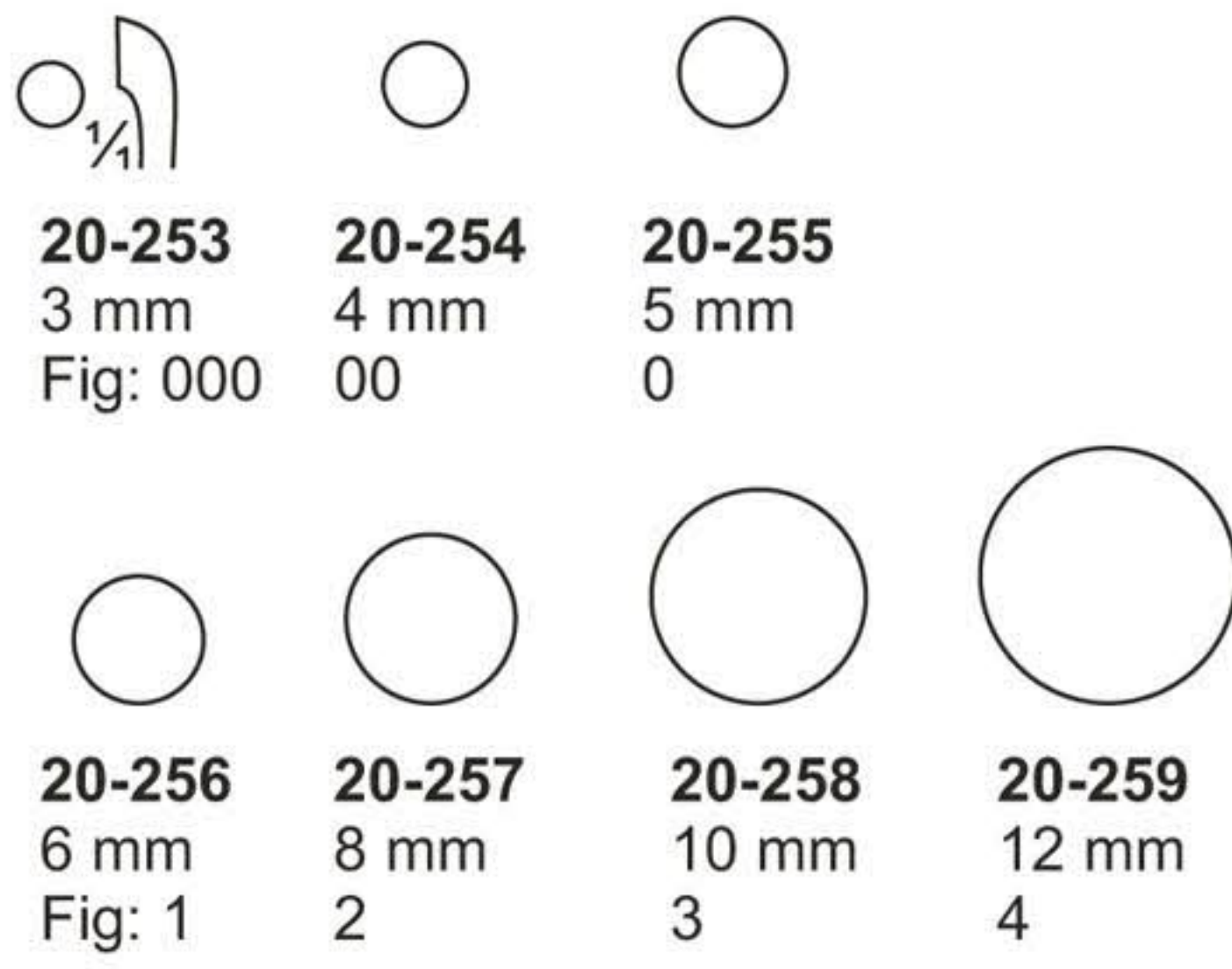

1/2

**20-253 - 259**  
 BRUNS  
 165 mm

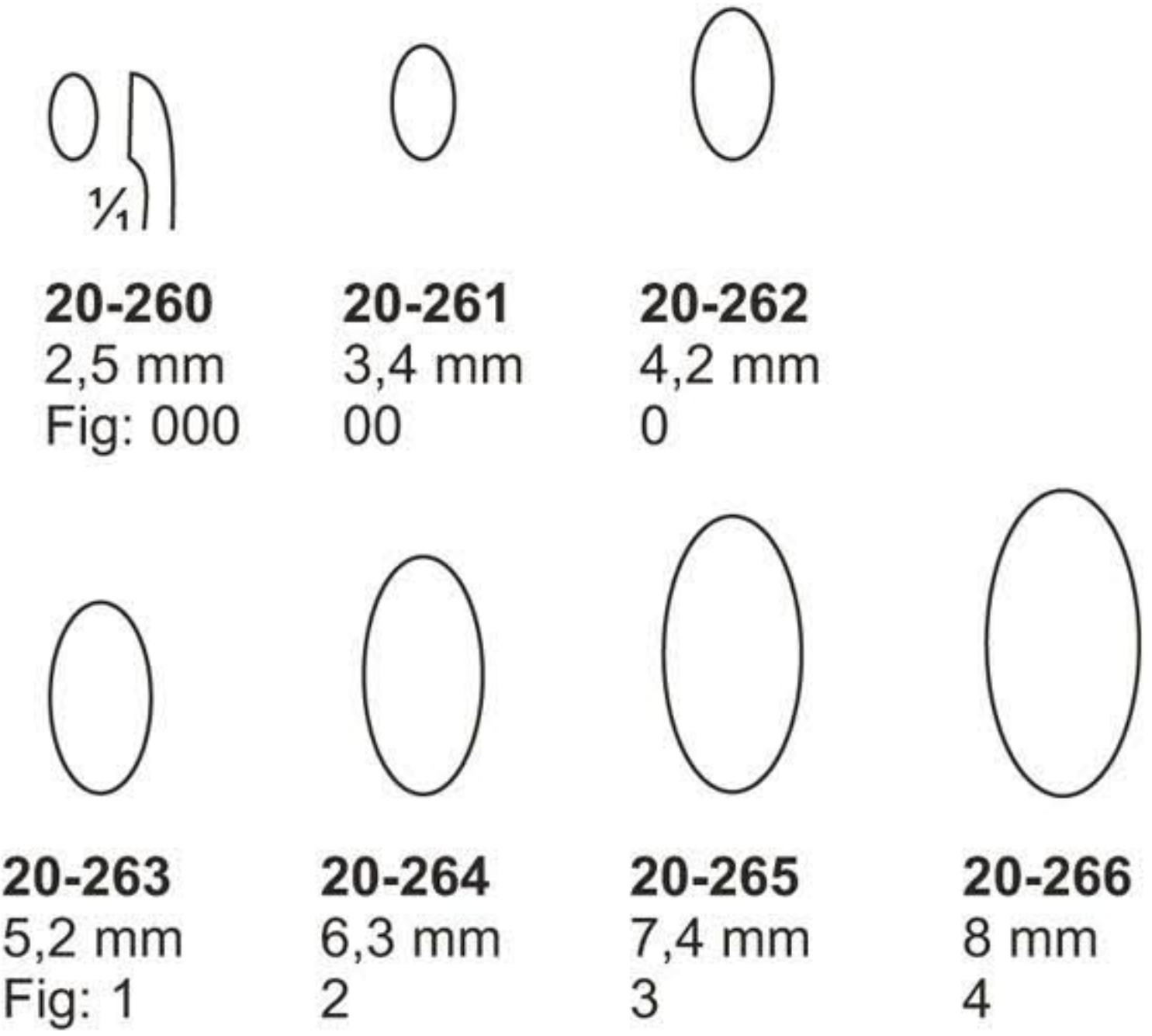

1/2

**20-260 - 266**  
 SCHEDE  
 170 mm

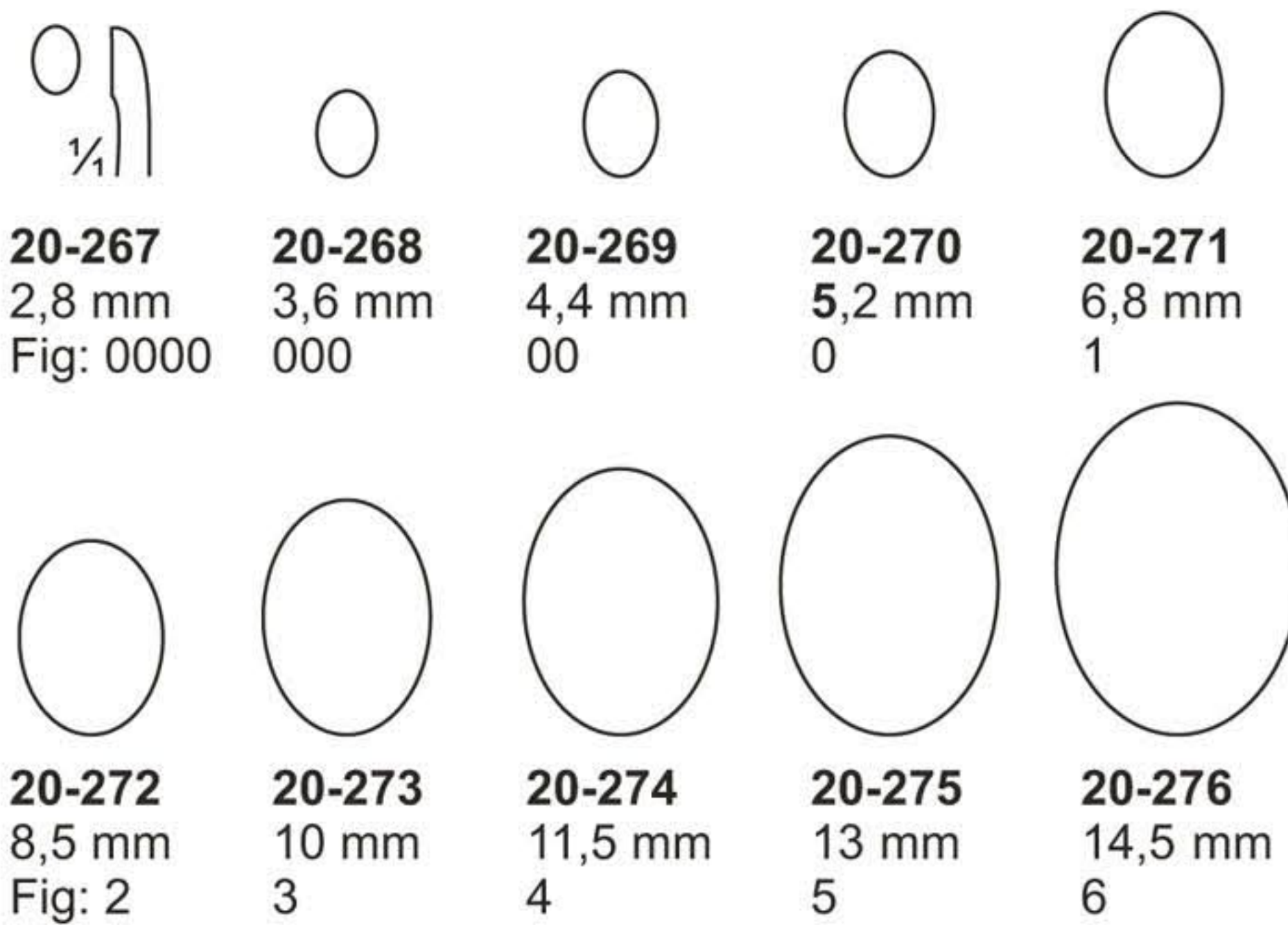
1/2

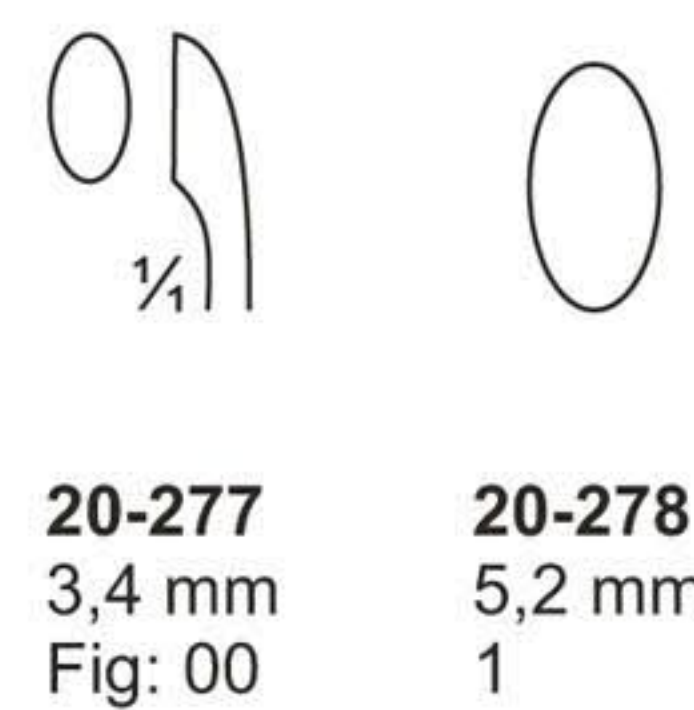

**20-267 - 276**  
 VOLKMANN  
 170 mm

1/2

**20-277 - 278**  
 WILLIGER  
 170 mm

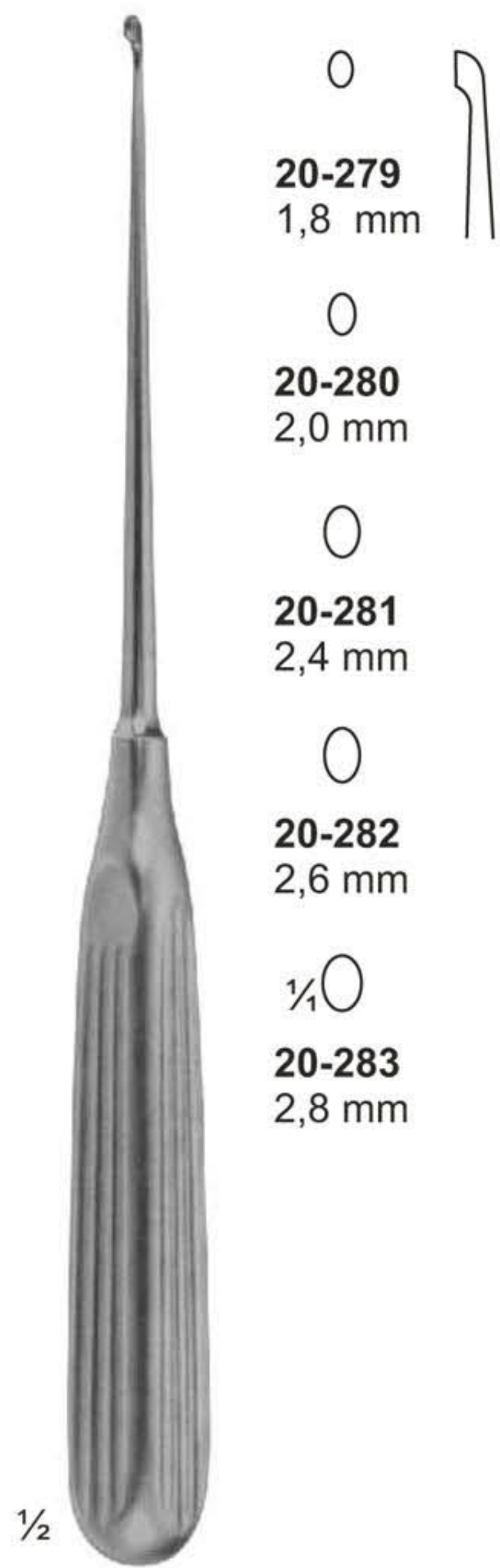

# Bone Curettes



-  **20-279**  
1,8 mm
-  **20-280**  
2,0 mm
-  **20-281**  
2,4 mm
-  **20-282**  
2,6 mm
-  **20-283**  
2,8 mm

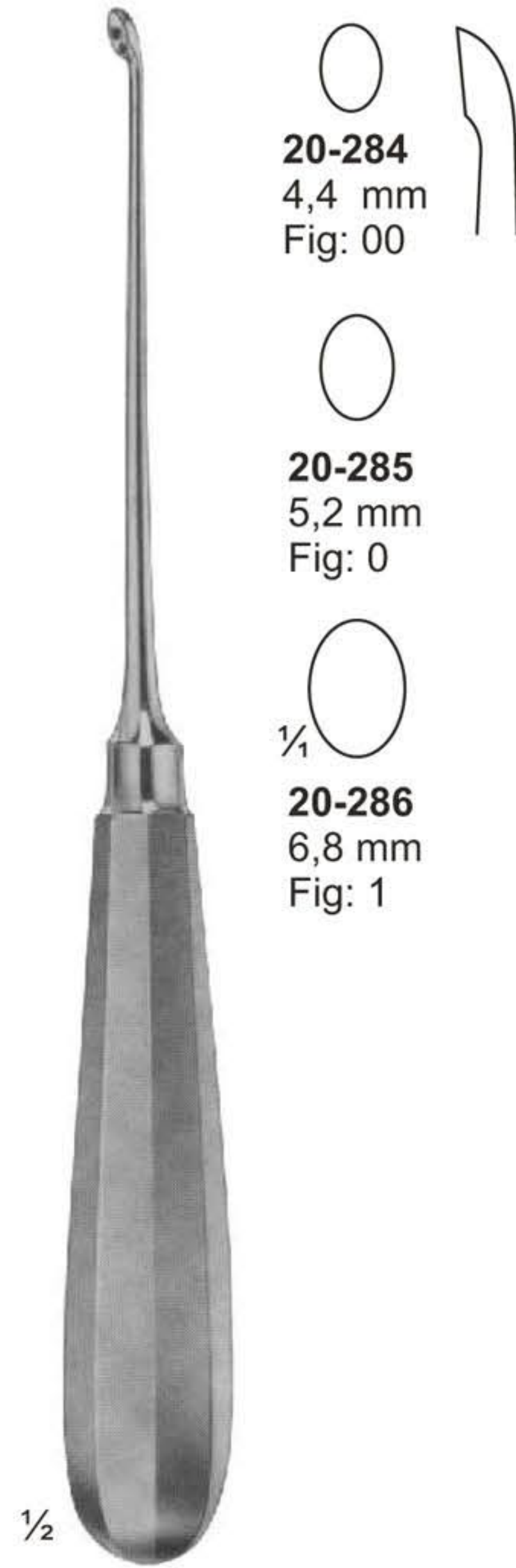

**20-279 - 283**  
LEMPERT  
215 mm



-  **20-284**  
4,4 mm  
Fig: 00
-  **20-285**  
5,2 mm  
Fig: 0
-  **20-286**  
6,8 mm  
Fig: 1

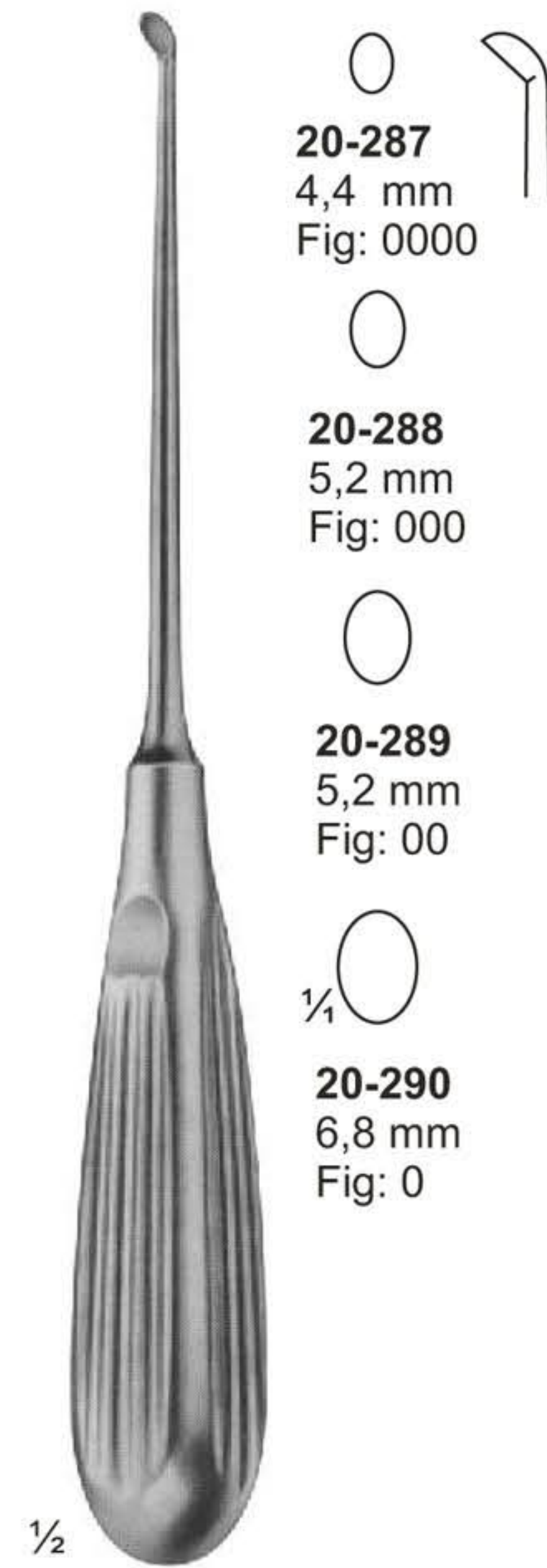

**20-284 - 286**  
HALLE  
215 mm

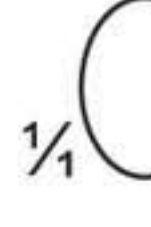

-  **20-287**  
4,4 mm  
Fig: 0000
-  **20-288**  
5,2 mm  
Fig: 000
-  **20-289**  
5,2 mm  
Fig: 00
-  **20-290**  
6,8 mm  
Fig: 0



**20-287 - 290**  
DAUBENSPECK  
200 mm

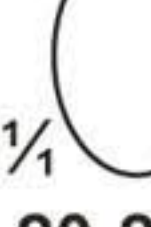

-  **20-291**  
3,6 mm  
Fig: 000
-  **20-292**  
4,4 mm  
Fig: 00
-  **20-293**  
5,2 mm  
Fig: 0
-  **20-294**  
6,8 mm  
Fig: 1

**20-291 - 294**  
250 mm

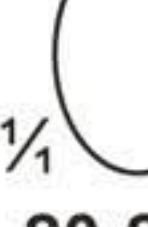

-  **20-295**  
3,6 mm  
Fig: 000
-  **20-296**  
4,4 mm  
Fig: 00
-  **20-297**  
5,2 mm  
Fig: 0
-  **20-298**  
6,8 mm  
Fig: 1

**20-295 - 298**  
250 mm



-  **20-299**  
3 mm
-  **20-300**  
4 mm
-  **20-301**  
5 mm

**20-299 - 301**  
BUSHE  
250 mm



# Bone Curettes



**20-302**  
TESSIER  
220 mm



**20-303**  
3,6 mm  
Fig: 000

**20-304**  
4,4 mm  
Fig: 00

**20-305**  
5,2 mm  
Fig: 0

**20-303 - 305**  
SIMON  
235 mm

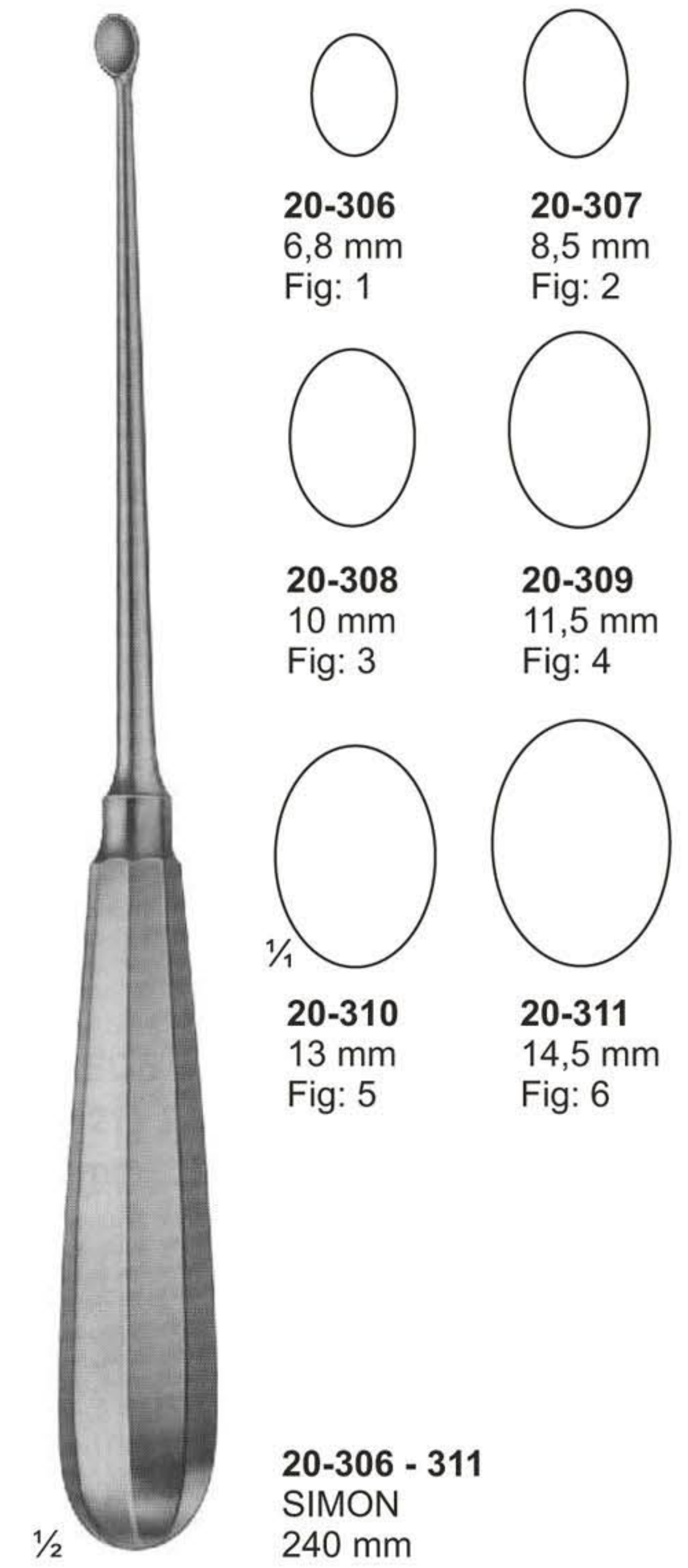

**20-306**  
6,8 mm  
Fig: 1

**20-307**  
8,5 mm  
Fig: 2

**20-308**  
10 mm  
Fig: 3

**20-309**  
11,5 mm  
Fig: 4

**20-310**  
13 mm  
Fig: 5

**20-311**  
14,5 mm  
Fig: 6

**20-306 - 311**  
SIMON  
240 mm

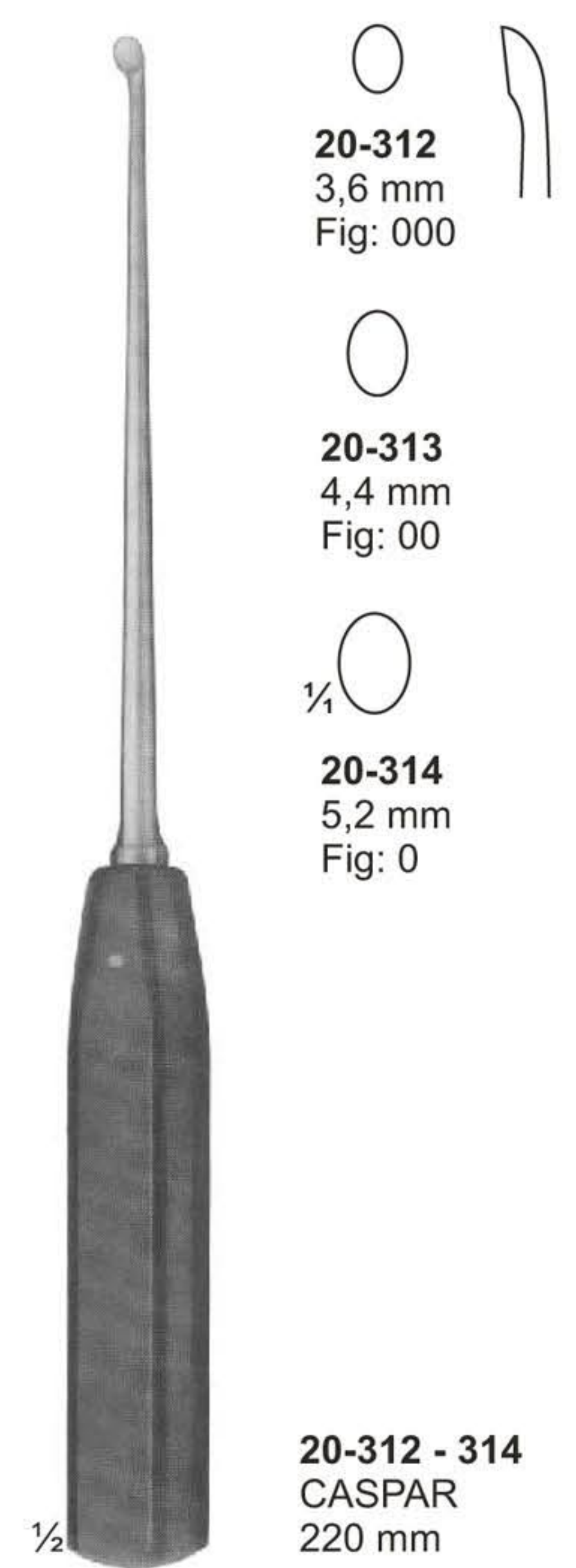

**20-312**  
3,6 mm  
Fig: 000

**20-313**  
4,4 mm  
Fig: 00

**20-314**  
5,2 mm  
Fig: 0

**20-312 - 314**  
CASPAR  
220 mm

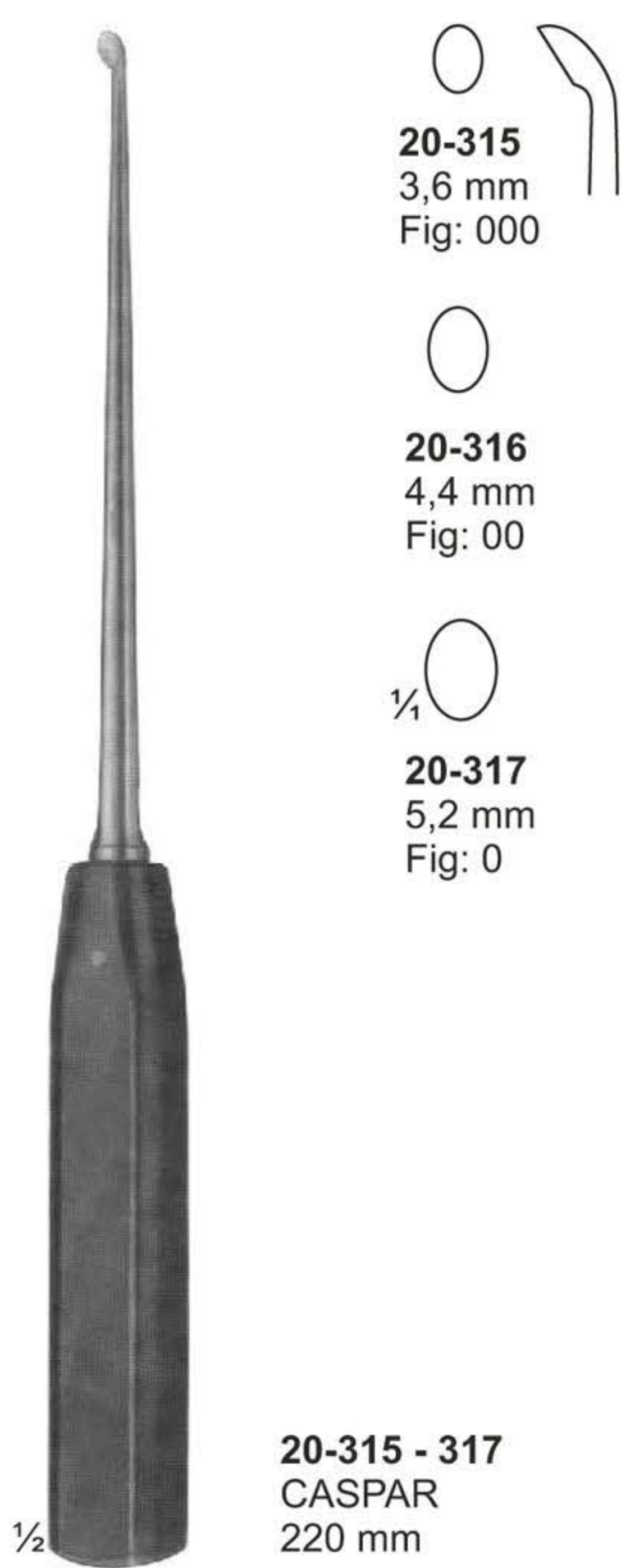

**20-315**  
3,6 mm  
Fig: 000

**20-316**  
4,4 mm  
Fig: 00

**20-317**  
5,2 mm  
Fig: 0

**20-315 - 317**  
CASPAR  
220 mm

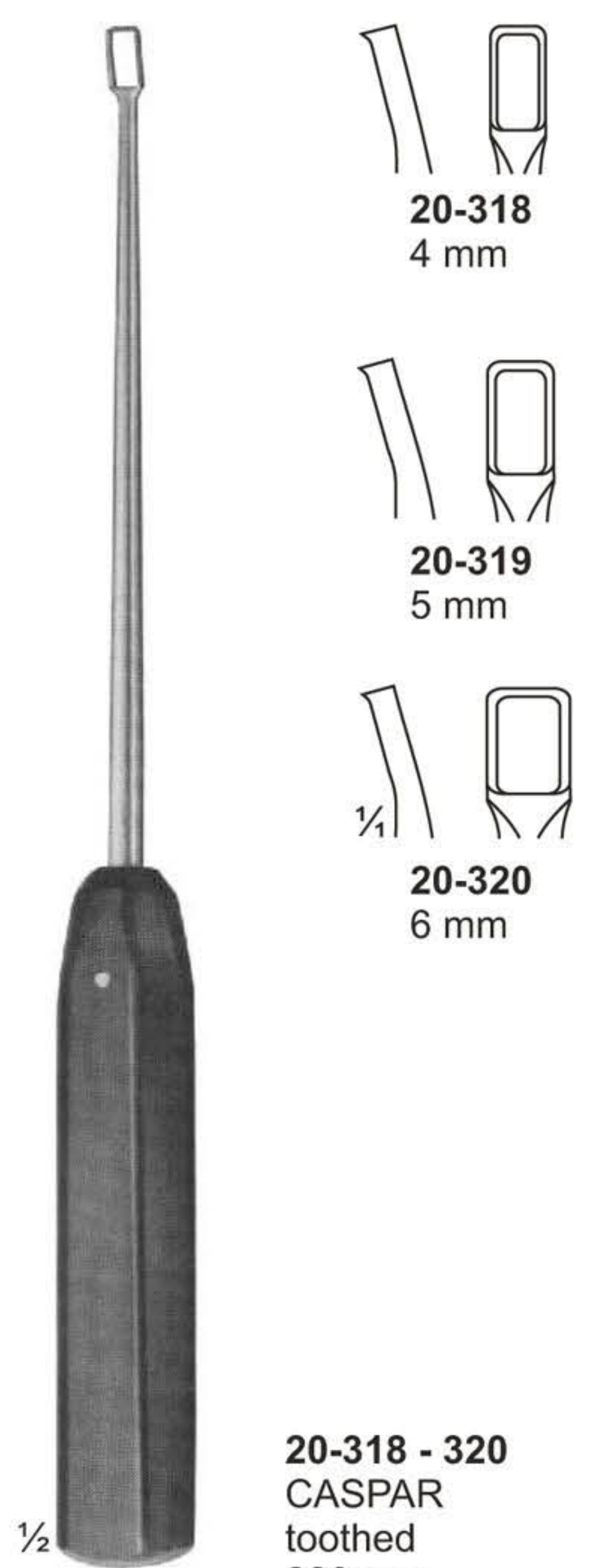

**20-318**  
4 mm

**20-319**  
5 mm

**20-320**  
6 mm

**20-318 - 320**  
CASPAR  
toothed  
220 mm



# Bone Currettes

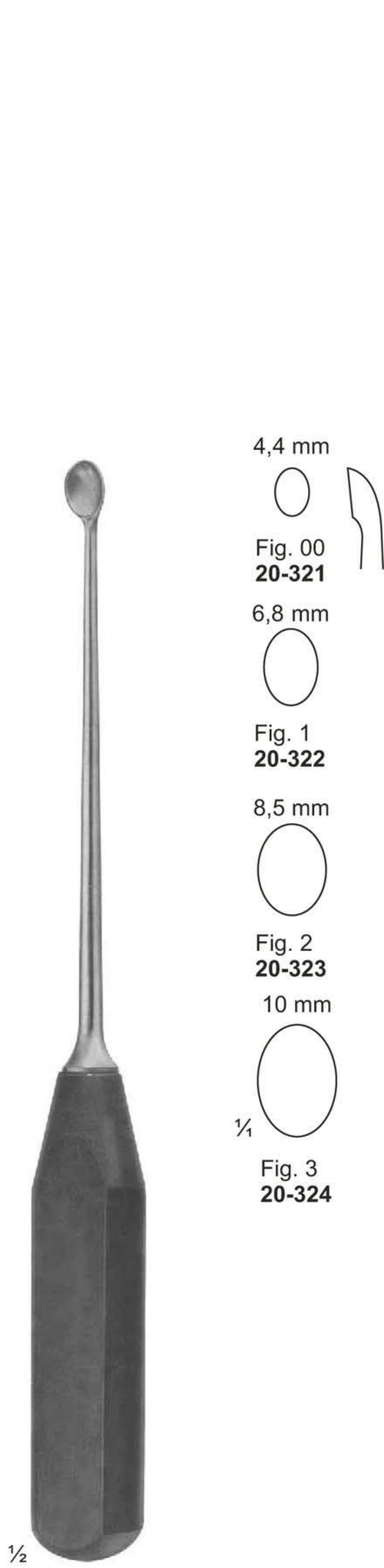

**20-321 - 324**  
270 mm

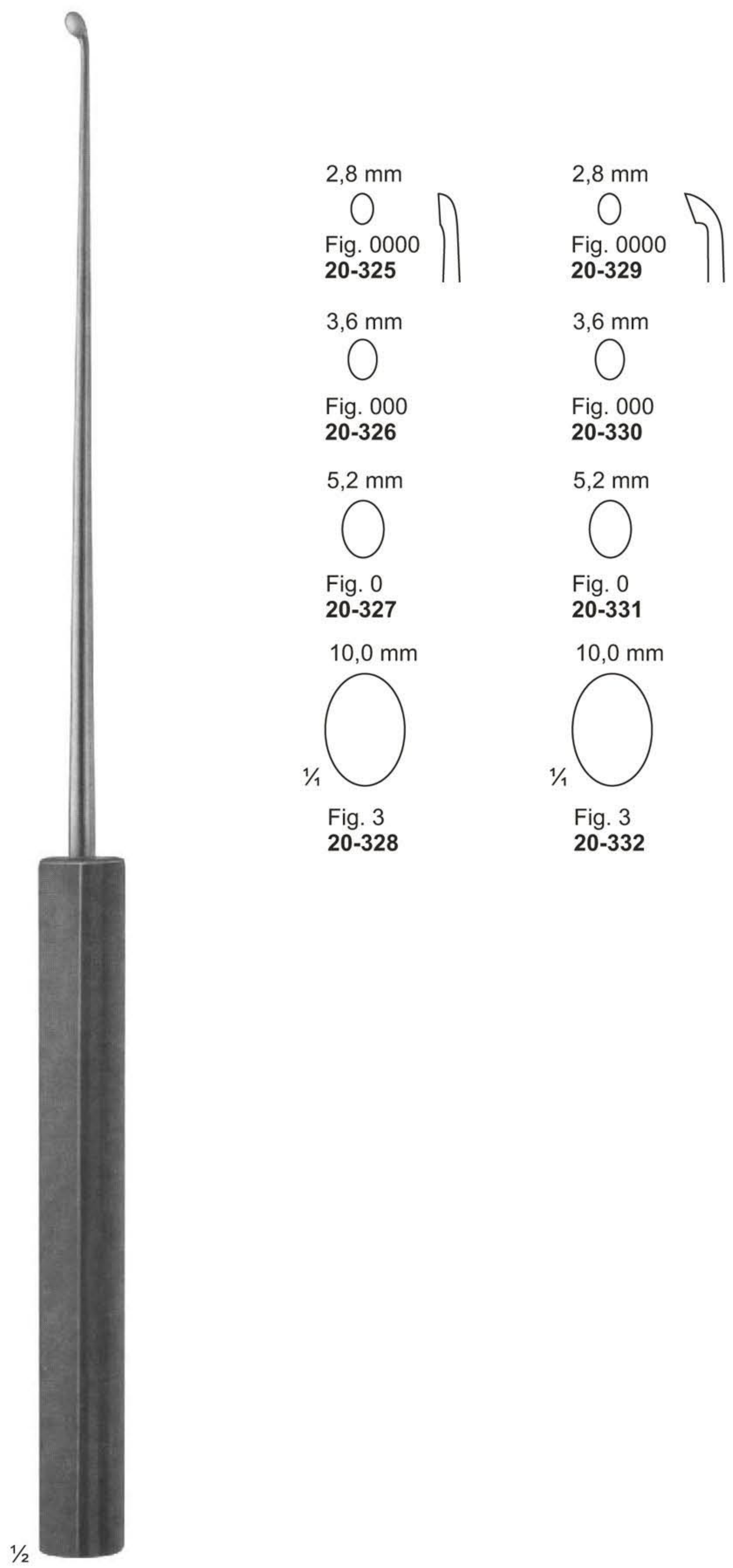

**20-325 - 332**  
SYPERT  
380 mm



## Mallets



∅ 20 mm

**21-101**  
MEAD  
185 g  
with interchangeable  
plastic disks  
190 mm  
**21-102**  
pair of spare disks



**21-103**  
140 g  
with interchangeable  
plastic disks  
185 mm  
**21-104**  
pair of spare disks



∅ 25 mm

**21-105**  
COTTLE  
140 g  
1 Seite convex  
1 Side convex  
185 mm



∅ 22 mm

**21-106**  
165 g  
lead filled head  
190 mm



**Mallets**



**21-107**  
HAJEK  
140 g  
215 mm



**21-108**  
215 g  
with interchangeable  
plastic disks  
245 mm  
**21-109**  
pair of spare disks



**21-110 - 113**  
WAGNER  
complete with:  
1 pair of metal disks and  
1 pair of plastic disks and  
1 wrench 566  
235 mm

**21-111**  
1 metal disks, flat  
1 metal disks, convex

**21-112**  
1 plastic disks, flat  
1 plastic disks, convex

**21-113**  
Wrench

Mallet without disks 130 g



# Mallets



**21-114**  
BERGMANN  
245 mm



**21-115**  
BERGMANN  
235 mm





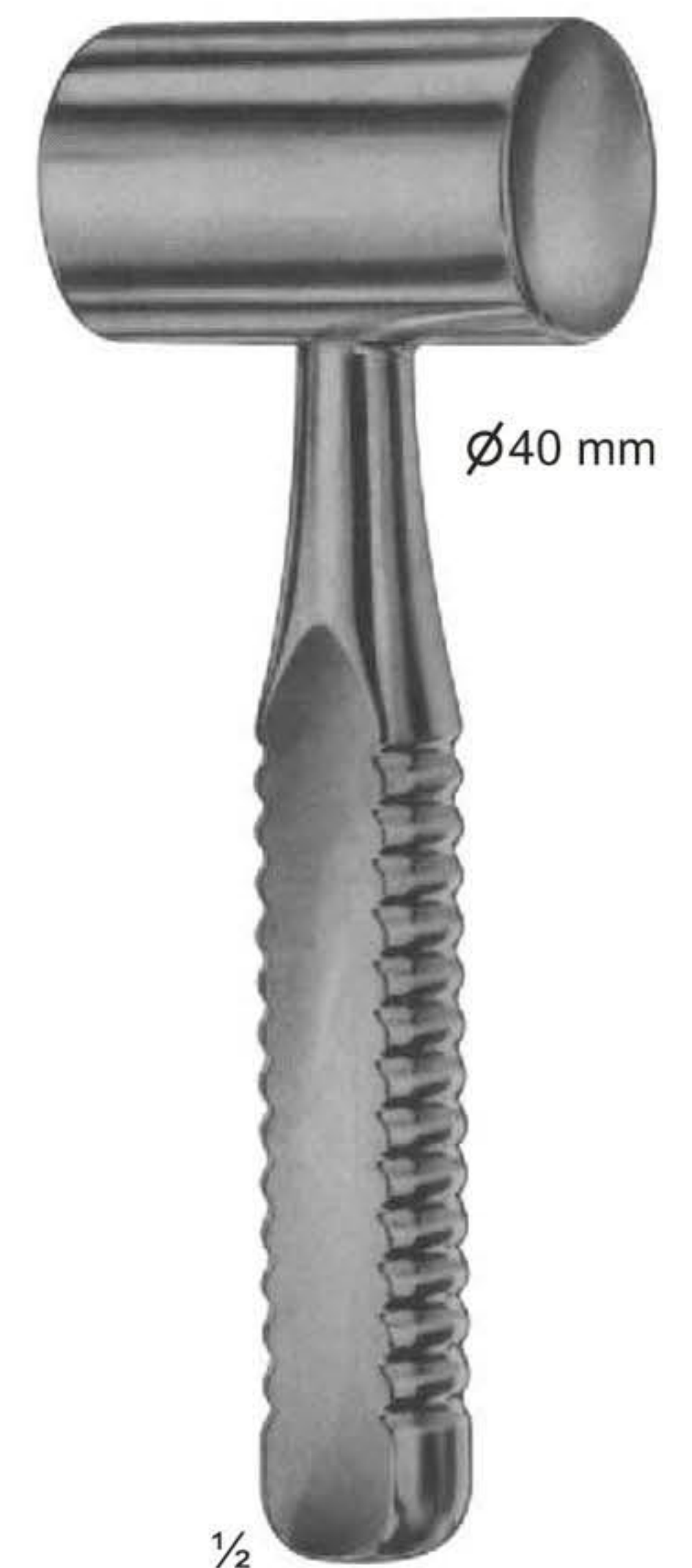







**21-116**  
OMBREDANNE  
240 mm



**21-117**  
HEATH  
copper filled head  
700 g  
185 mm



# Tampers - Osteotomes, Chisels and Gouges

 <p>5,7 mm 1/4</p>	 <p>□ 21-119 5,7 mm 1/4 □ 21-120 3,5 mm</p>	 <p>● 21-121 ∅3 mm ● 21-122 ∅5 mm 1/4 ● 21-123 ∅8 mm</p>	 <p>● 21-124 ∅12 mm ● 21-125 ∅14 mm 1/4 ● 21-126 ∅16 mm</p>		
<p><b>21-118</b> Haase 100 mm</p>	<p><b>21-119 - 120</b> PASSOW 120 mm</p>	<p><b>21-121 - 123</b> CASPER 200 mm</p>	<p><b>21-124 - 126</b> 200 mm</p>		
 <p>4 mm 1/4</p>	 <p>4 mm 1/4</p>	 <p>6 mm 1/4</p>	 <p>3,4 mm 1/4</p>	 <p>3,4 mm 1/4</p>	 <p>1/4</p>
<p><b>21-127</b> FREER Chisel 160 mm</p>	<p><b>21-128</b> FREER Chisel, curved 160 mm</p>	<p><b>21-129</b> FREER Gouge 150 mm</p>	<p><b>21-130</b> Scaphoid gouge, downwards curved 135 mm</p>	<p><b>21-131</b> Scaphoid gouge, upwards curved 135 mm</p>	<p><b>21-131A - 133</b> Mannerfelt 21-131A 4 mm 21-132 6 mm 21-133 8 mm 155 mm</p>



# Osteotomes Chisels and Gouges



**21-134**  
 Mannerfelt  
 155 mm

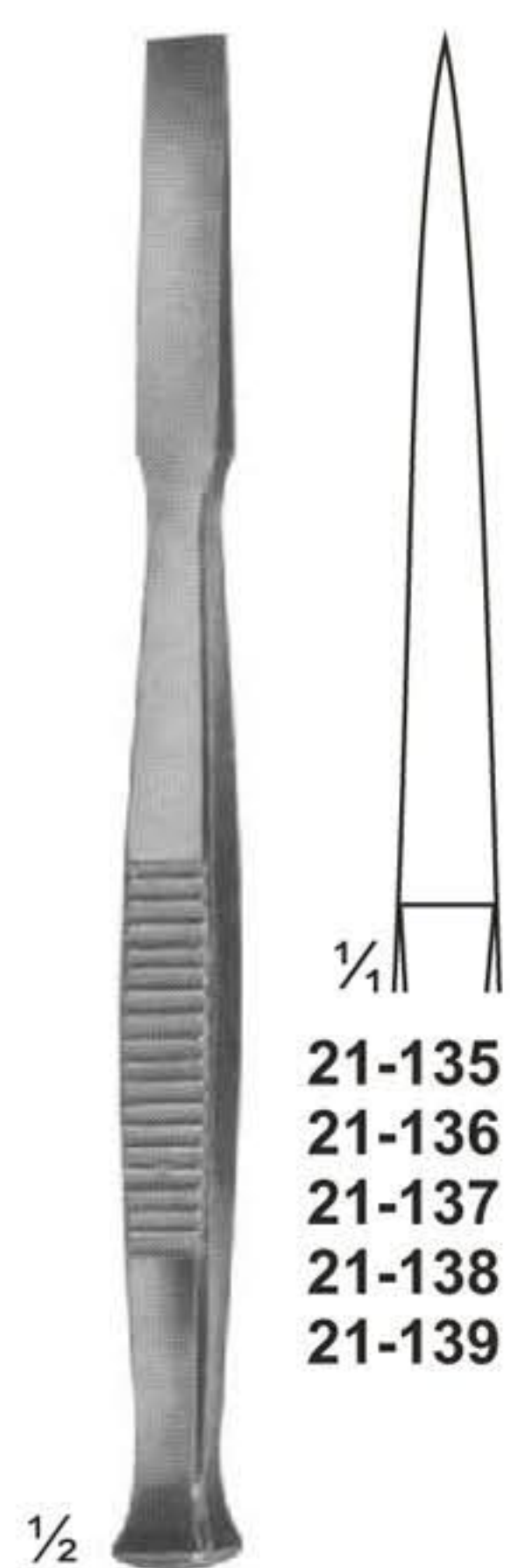

**21-135 - 139**  
 Osteotome  
 140 mm

- 21-135** 4 mm
- 21-136** 6 mm
- 21-137** 8 mm
- 21-138** 10 mm
- 21-139** 12 mm

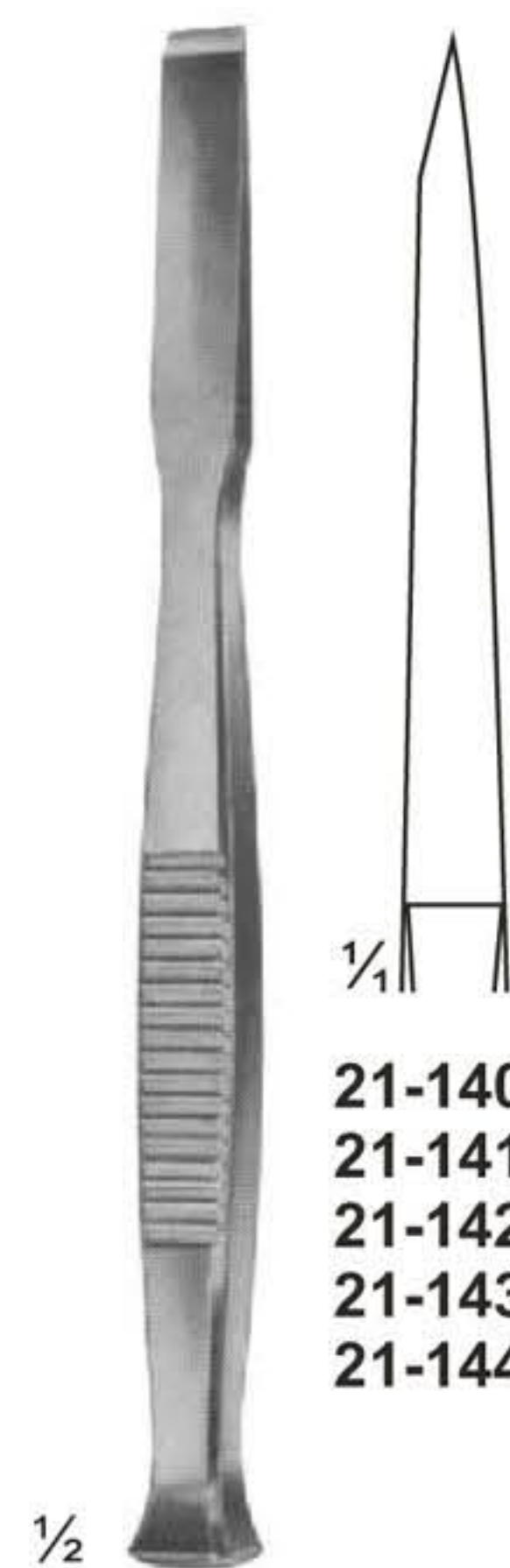

**21-140 - 144**  
 Chisels  
 140 mm

- 21-140** 4 mm
- 21-141** 6 mm
- 21-142** 8 mm
- 21-143** 10 mm
- 21-144** 12 mm

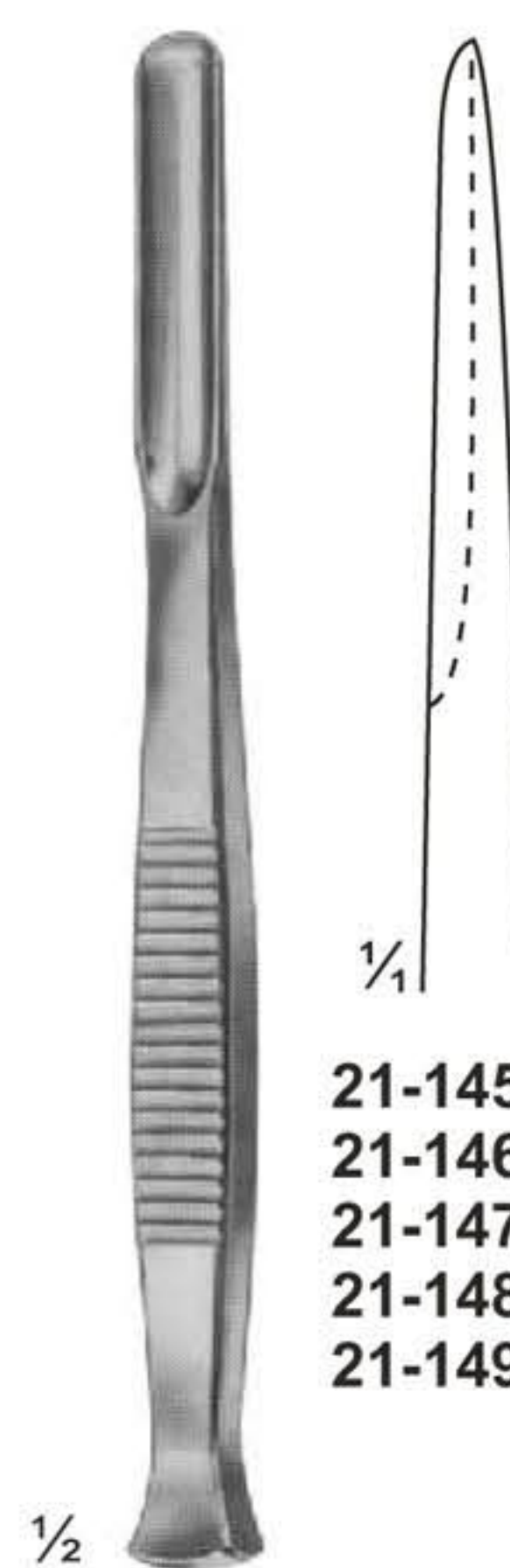

**21-145 - 149**  
 Gouges  
 140 mm

- 21-145** 4 mm
- 21-146** 6 mm
- 21-147** 8 mm
- 21-148** 10 mm
- 21-149** 12 mm

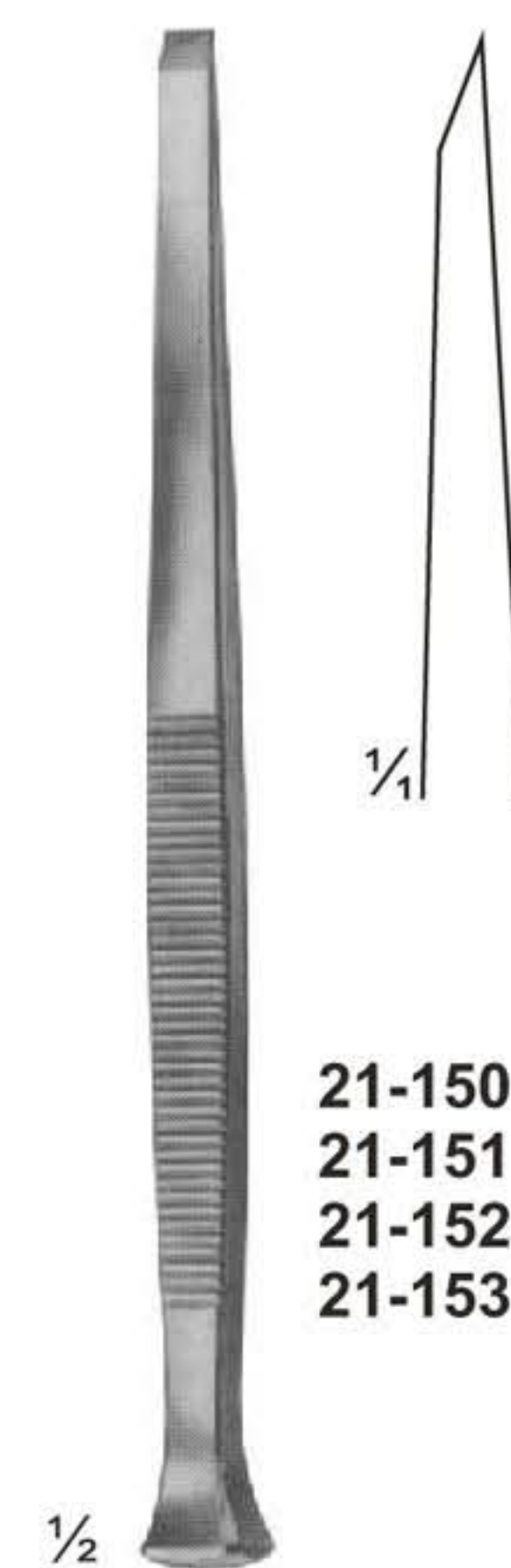

**PARTSCH**  
**21-150 - 153**  
 Chisels  
 140 mm

- 21-150** 3 mm
- 21-151** 4 mm
- 21-152** 5 mm
- 21-153** 6 mm

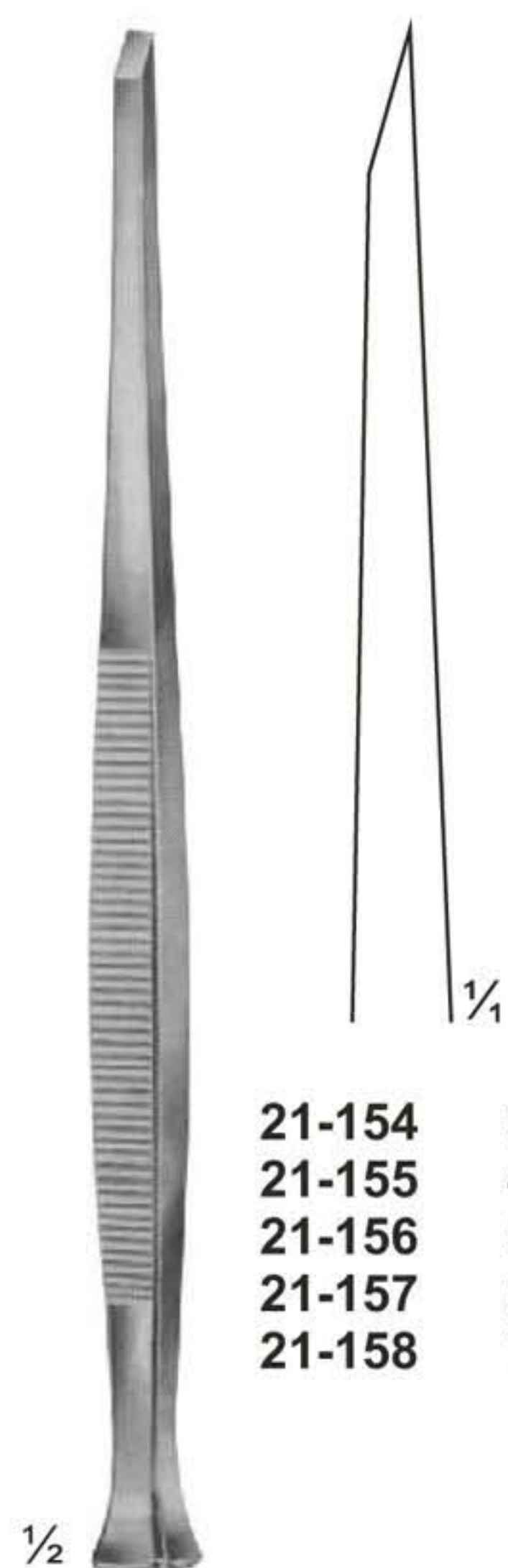

**PARTSCH**  
**21-154 - 158**  
 Chisels  
 170 mm

- 21-154** 3 mm
- 21-155** 4 mm
- 21-156** 5 mm
- 21-157** 6 mm
- 21-158** 7 mm

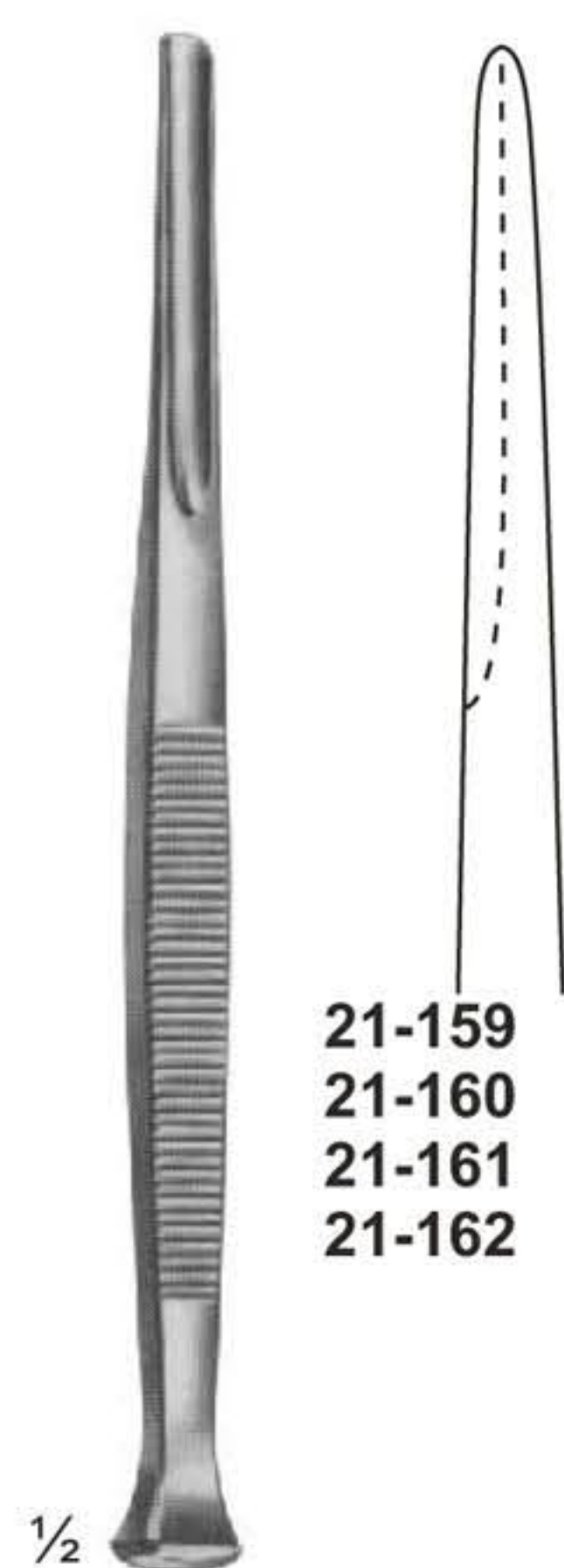

**PARTSCH**  
**21-159 - 162**  
 Gouges  
 140 mm

- 21-159** 3 mm
- 21-160** 4 mm
- 21-161** 5 mm
- 21-162** 6 mm

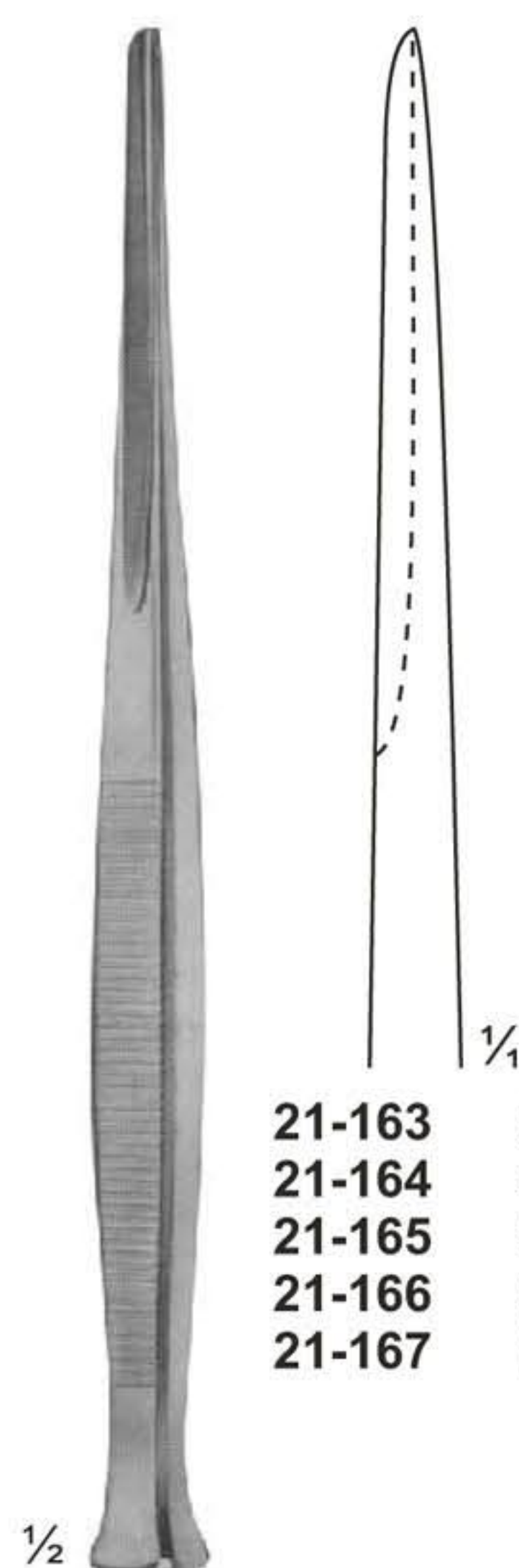

**PARTSCH**  
**21-163 - 167**  
 Gouges  
 170 mm

- 21-163** 3 mm
- 21-164** 4 mm
- 21-165** 5 mm
- 21-166** 6 mm
- 21-167** 7 mm

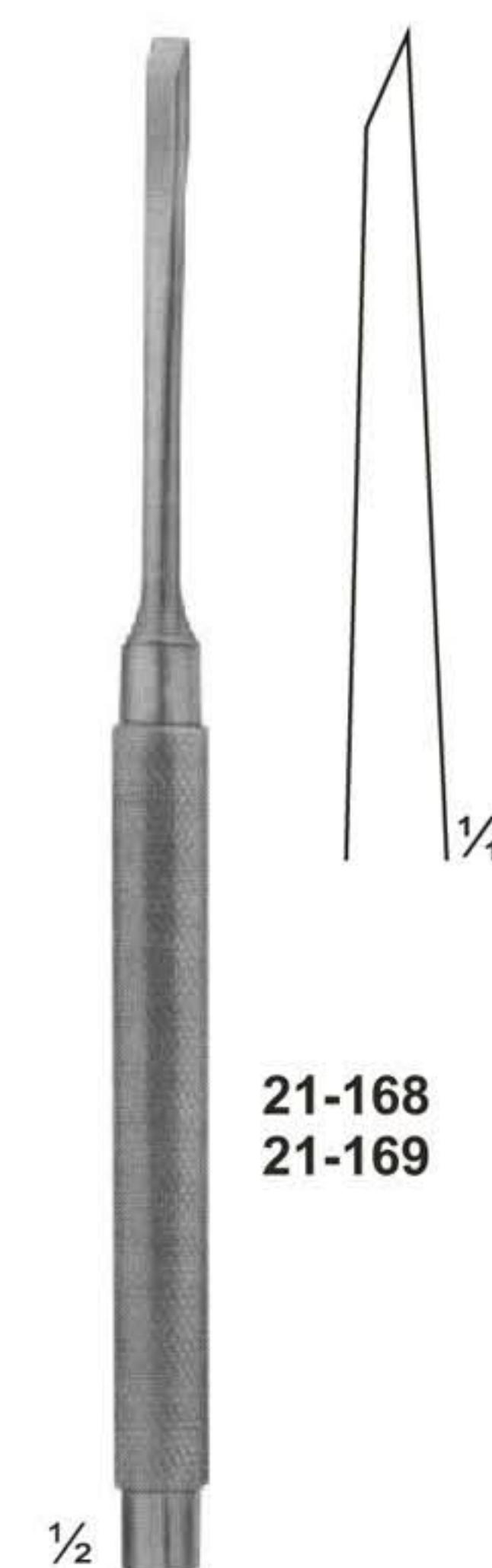

**LUCAS**  
**21-168 - 169**  
 Chisels  
 160 mm

- 21-168** 4 mm
- 21-169** 6 mm



**LUCAS**  
**21-170 - 171**  
 Gouges  
 160 mm

- 21-170** 3 mm
- 21-171** 5 mm



# Osteotomes Chisels and Gouges

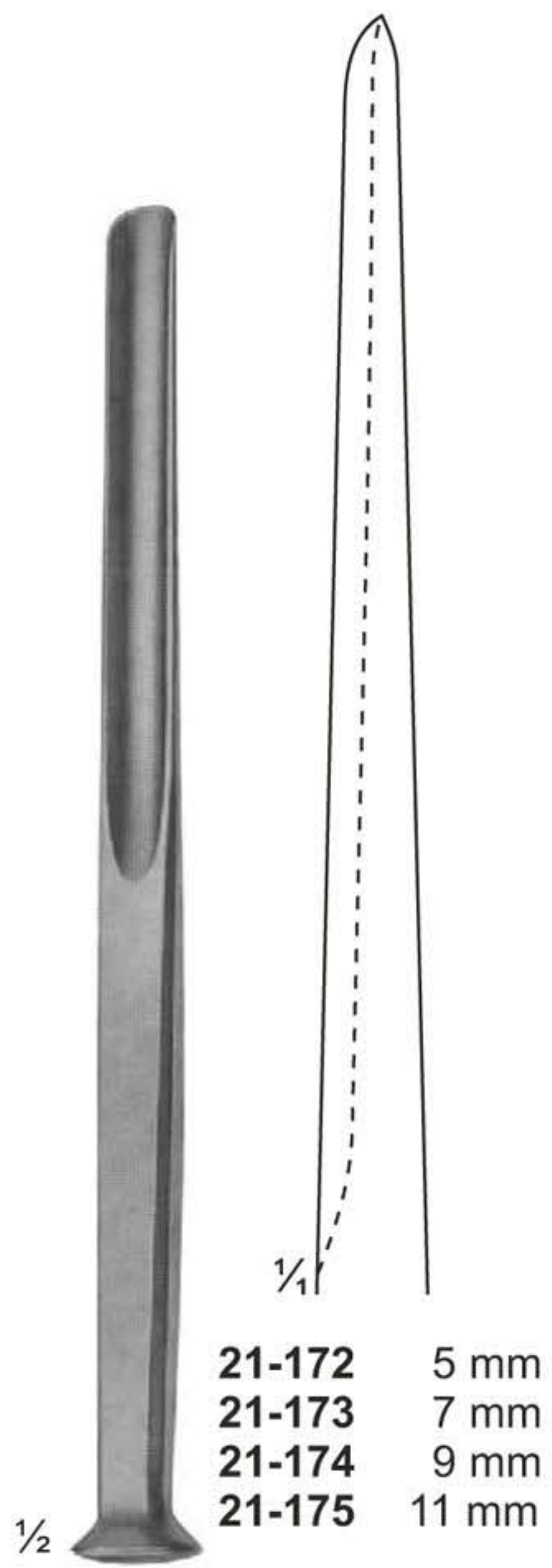

21-172 5 mm  
 21-173 7 mm  
 21-174 9 mm  
 21-175 11 mm

**ALEXANDER**  
**21-172 - 175**  
 Gouges  
 170 mm

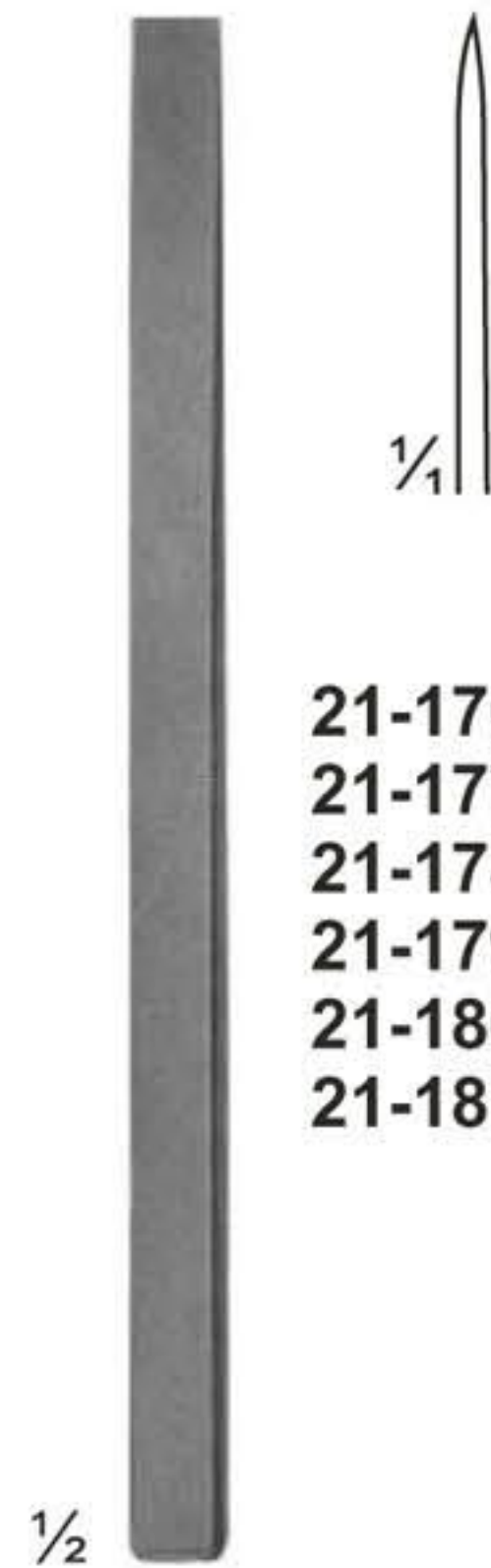

21-176 4 mm  
 21-177 6 mm  
 21-178 8 mm  
 21-179 10 mm  
 21-180 12 mm  
 21-181 15 mm

**LAMBOTTE**  
**21-176 - 181**  
 Osteotome  
 125 mm

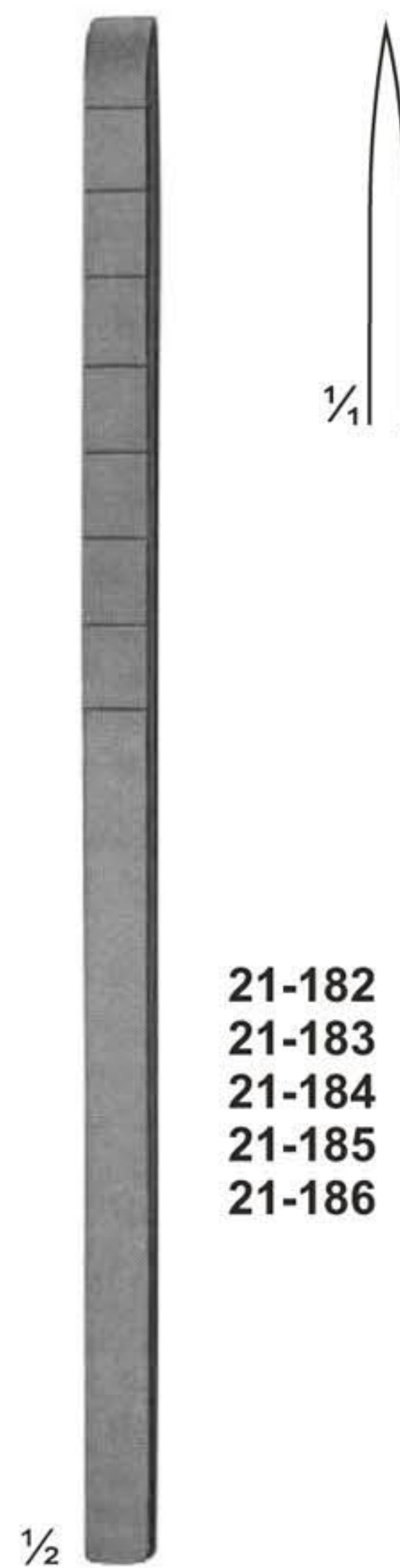

21-182 4 mm  
 21-183 6 mm  
 21-184 8 mm  
 21-185 10 mm  
 21-186 12 mm

**COTTLE**  
**21-182 - 186**  
 Osteotome with depth  
 markings  
 180 mm

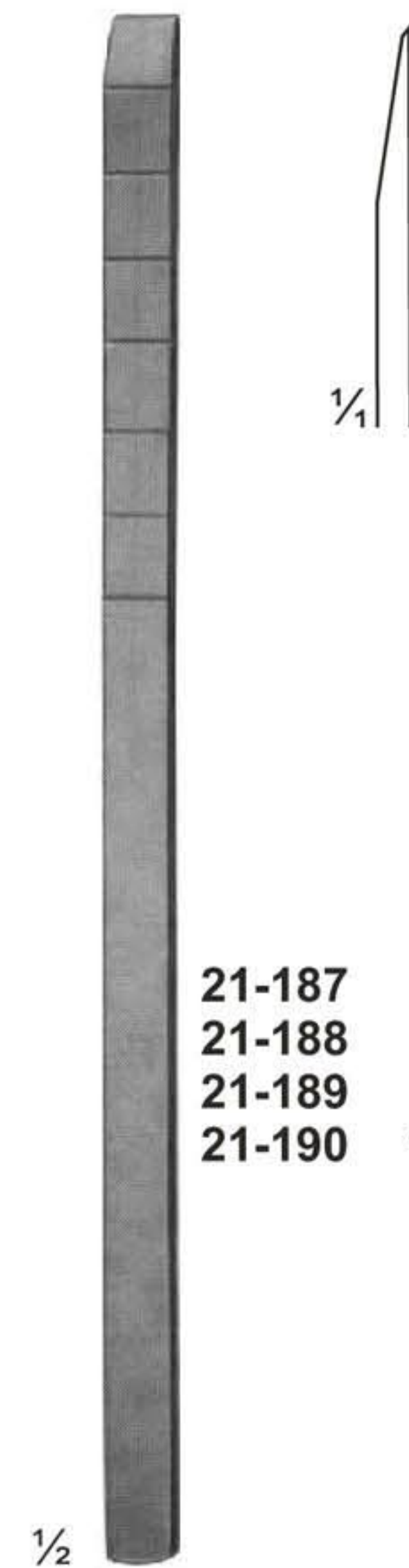

21-187 4 mm  
 21-188 7 mm  
 21-189 9 mm  
 21-190 12 mm

**COTTLE**  
**21-187 - 190**  
 Chisel-Osteotomes  
 with depth markings  
 180 mm

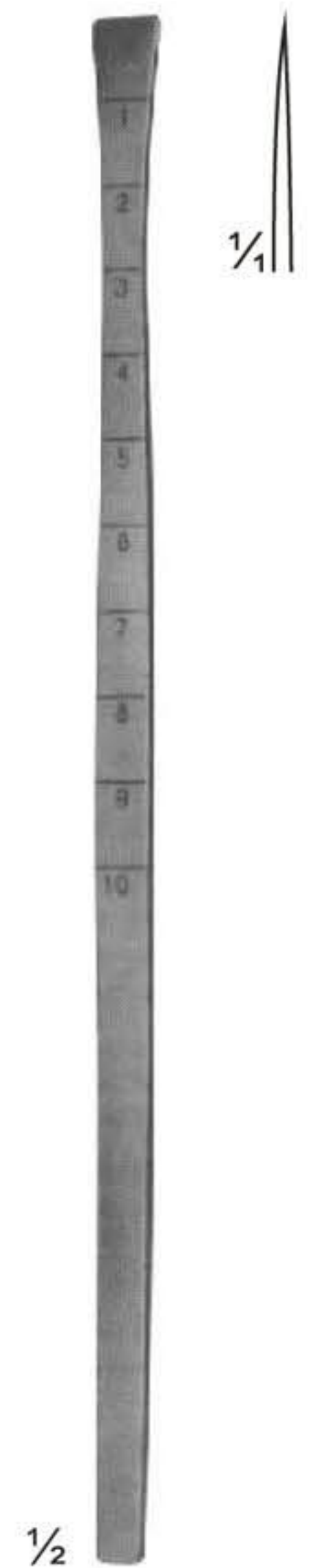

**COTTLE**  
**21-191**  
 Fishtail Chisel,  
 with protected ends  
 180 mm



21-192 10 mm  
 21-193 12 mm  
 21-194 15 mm  
 21-195 20 mm  
 21-196 25 mm

**STILLE**  
**21-192 - 196**  
 Chisels  
 205 mm

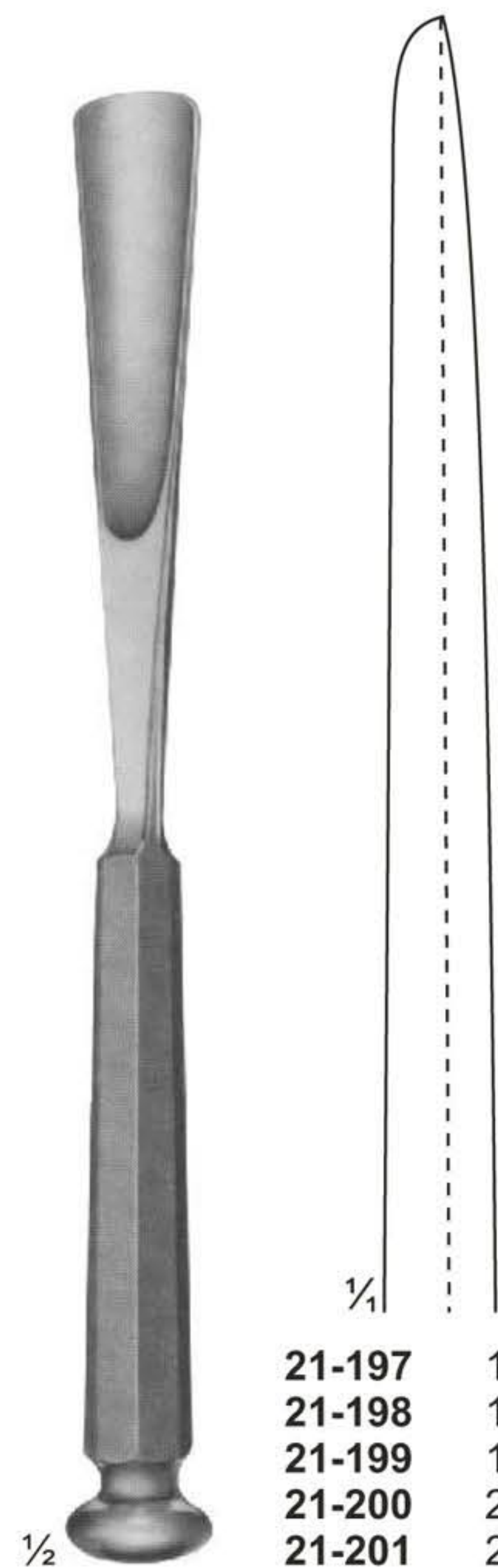

21-197 10 mm  
 21-198 12 mm  
 21-199 15 mm  
 21-200 20 mm  
 21-201 25 mm

**STILLE**  
**21-197 - 201**  
 Gouges  
 205 mm

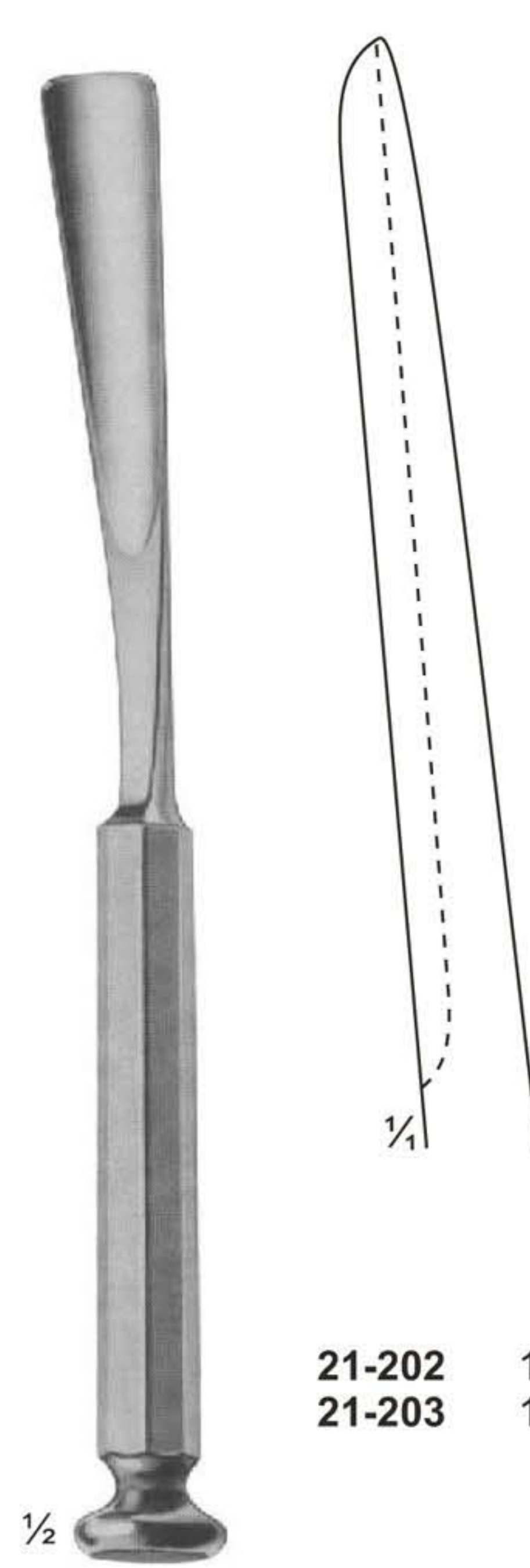

21-202 10 mm  
 21-203 15 mm

**WALTER**  
**21-202 - 203**  
 Osteotomes  
 gouges for taking  
 grafts from the rib  
 205 mm



21-204 8 mm  
 21-205 12 mm  
 21-206 15 mm  
 21-207 20 mm  
 21-208 25 mm

**STILLE**  
**21-204 - 208**  
 Osteotomes  
 205 mm



# Osteotomes



STILLE  
 21-209 - 213  
 Osteotomes  
 205 mm

STILLE  
 21-214 - 218  
 Osteotomes, curved  
 205 mm

LAMBOTTE  
 21-219 - 230  
 Osteotomes  
 245 mm

LAMBOTTE  
 21-231 - 236  
 Osteotomes, curved  
 245 mm



# Osteotomes, Chisels and Gouges with HARTPRESS-handle

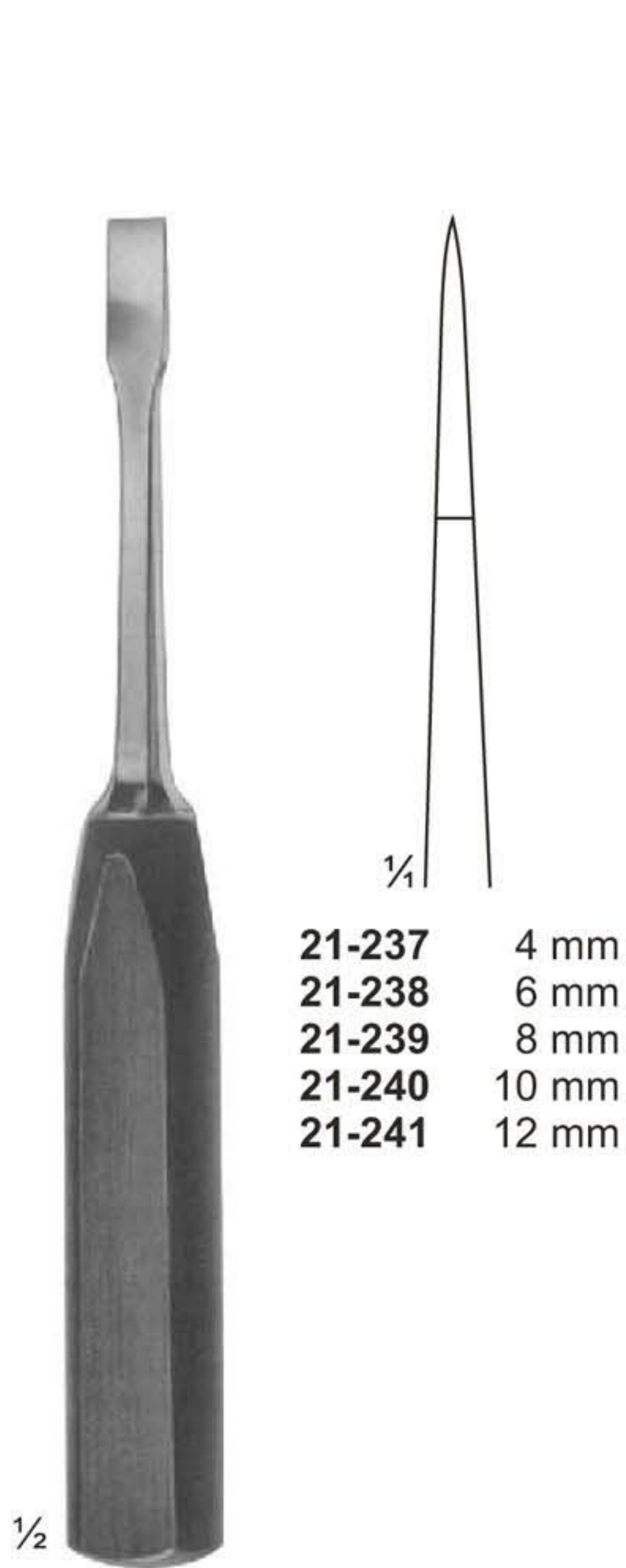

- 21-237 4 mm
- 21-238 6 mm
- 21-239 8 mm
- 21-240 10 mm
- 21-241 12 mm

**LEXER-MINI**  
**21-237 - 241**  
Osteotomes  
180 mm

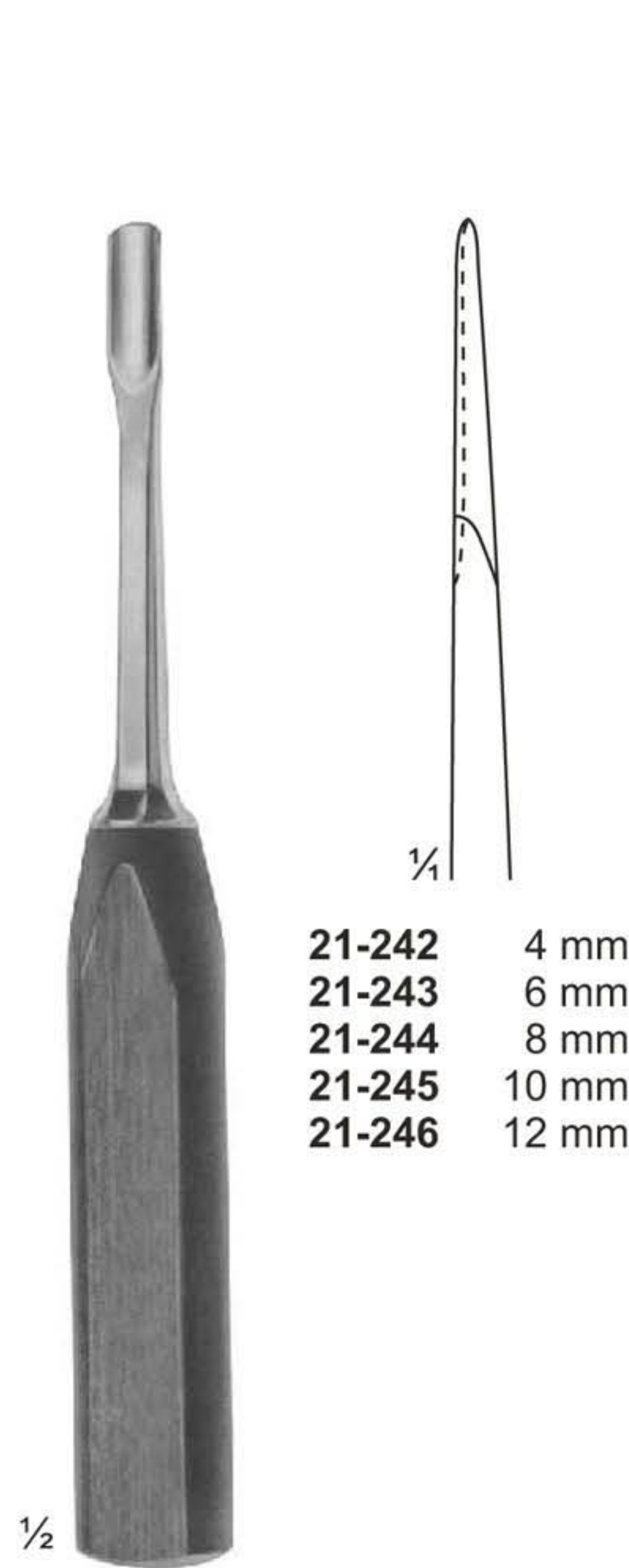

- 21-242 4 mm
- 21-243 6 mm
- 21-244 8 mm
- 21-245 10 mm
- 21-246 12 mm

**LEXER-MINI**  
**21-242 - 246**  
Gouges  
180 mm

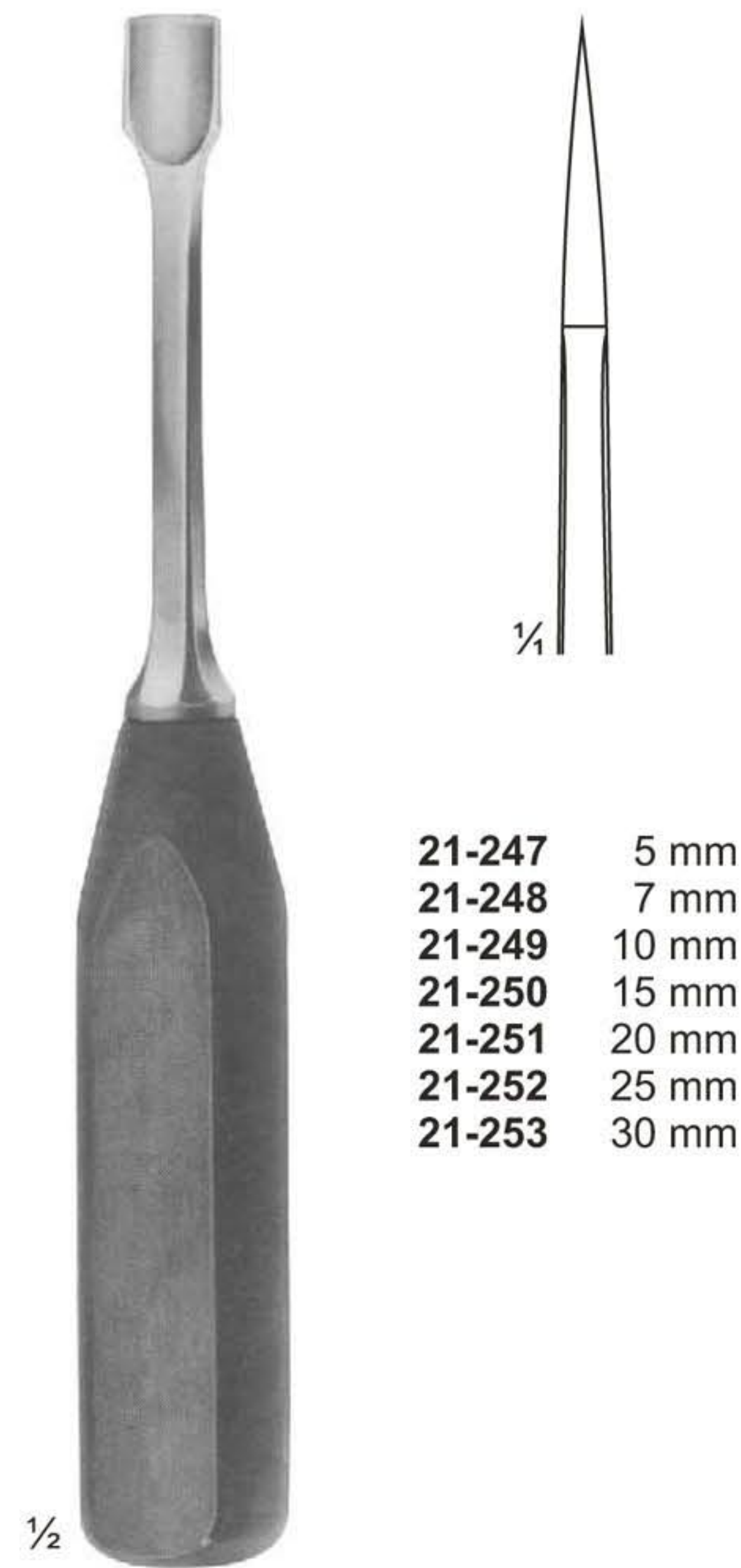

- 21-247 5 mm
- 21-248 7 mm
- 21-249 10 mm
- 21-250 15 mm
- 21-251 20 mm
- 21-252 25 mm
- 21-253 30 mm

**LEXER**  
**21-247 - 253**  
Osteotomes  
220 mm

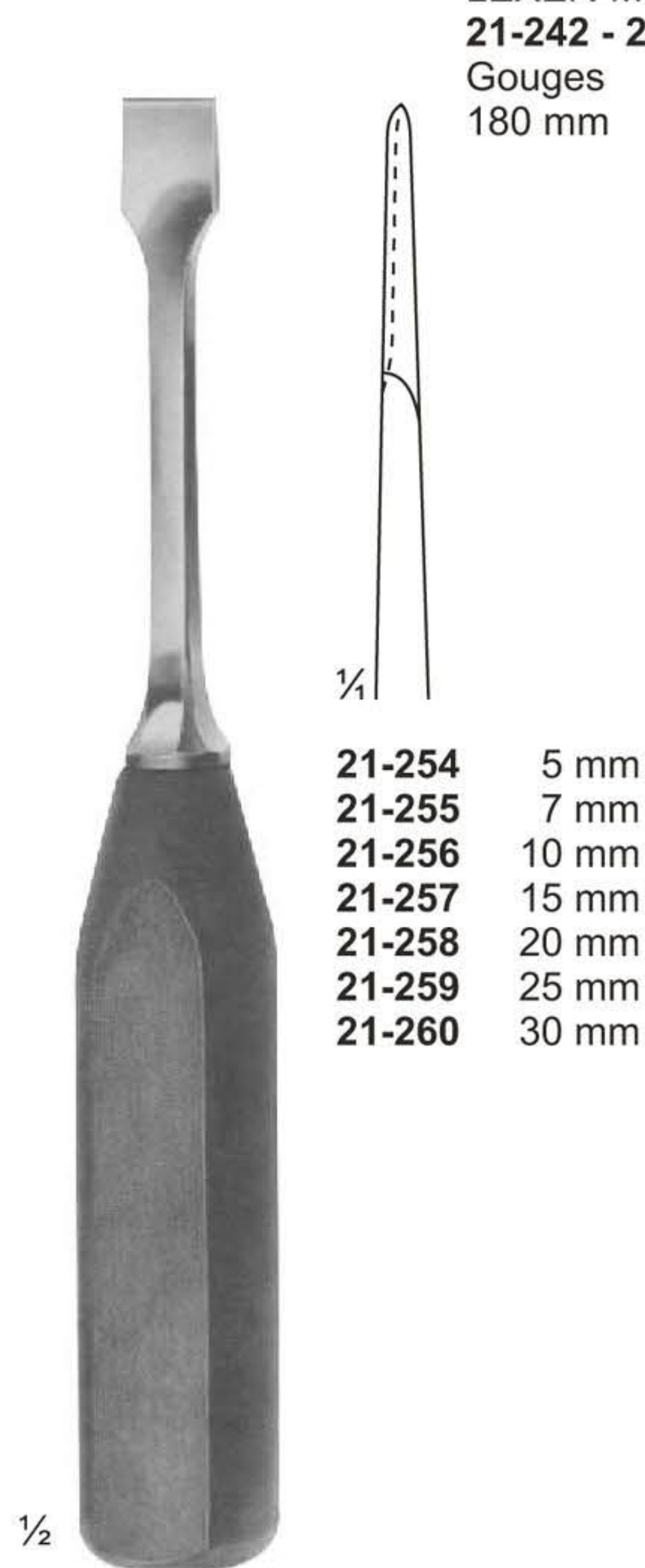

- 21-254 5 mm
- 21-255 7 mm
- 21-256 10 mm
- 21-257 15 mm
- 21-258 20 mm
- 21-259 25 mm
- 21-260 30 mm

**LEXER**  
**21-254 - 260**  
Gouges  
220 mm

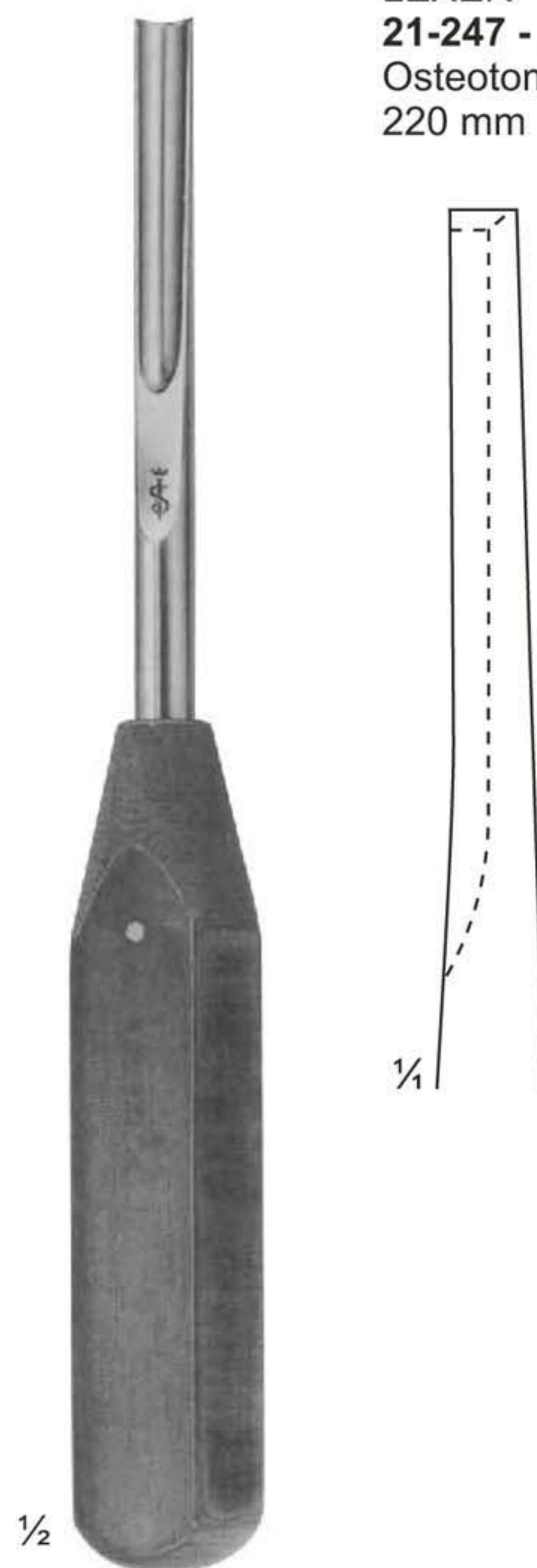

**LEXER**  
**21-261**  
Gouge for  
removing broken  
screws  
220 mm

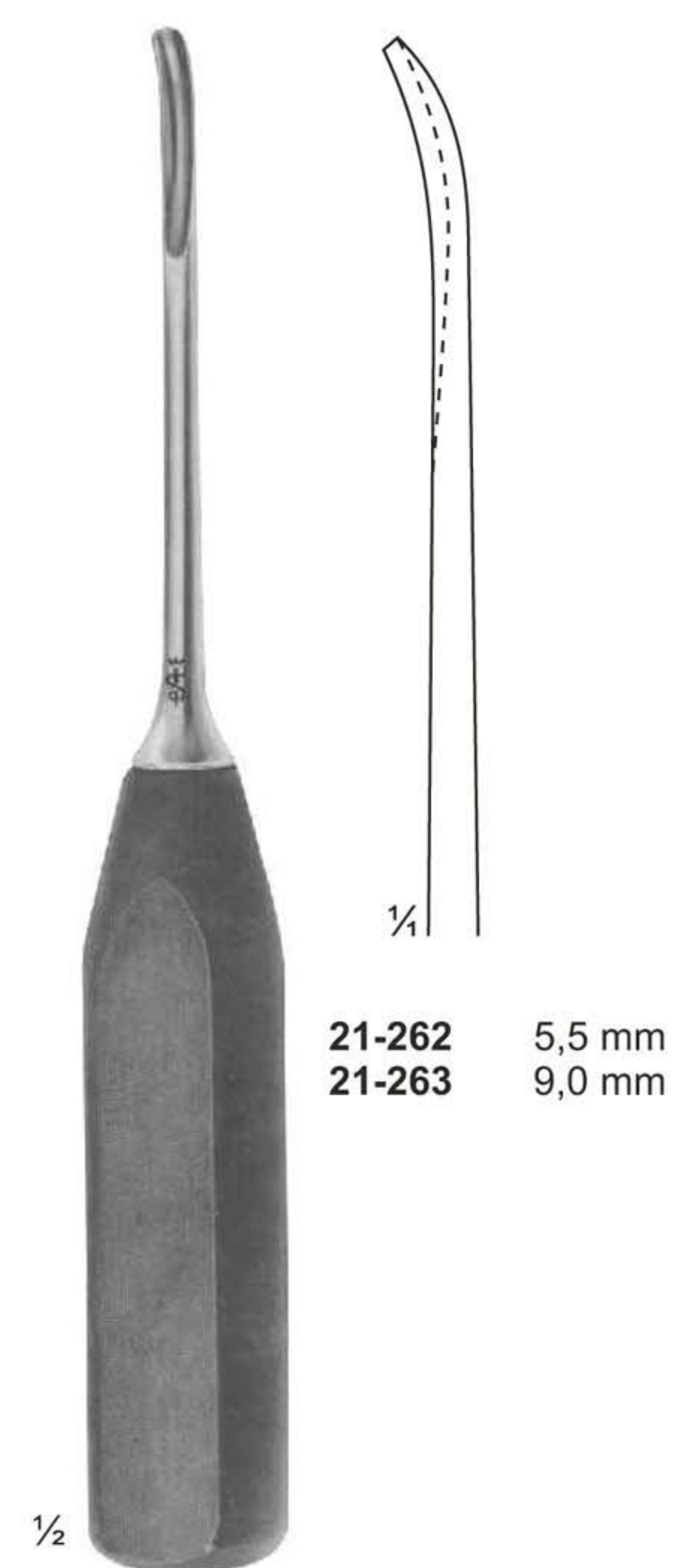

- 21-262 5,5 mm
- 21-263 9,0 mm

**ZIELKE**  
**21-262 - 263**  
Gouge for  
scoliose-operations  
230 mm



Osteotomes ,Chisels and Gouges with HARTPRESS -handle

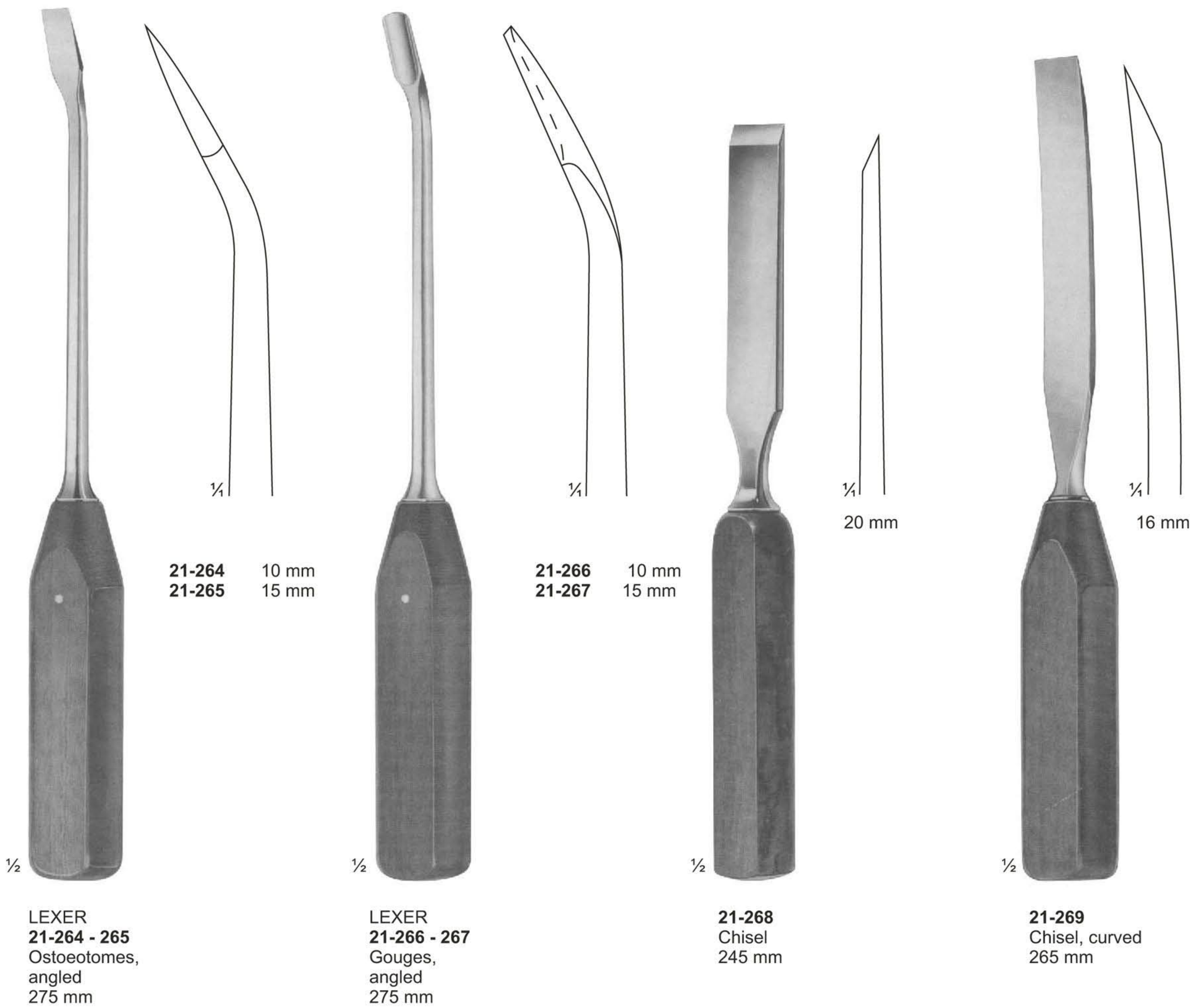



# Reposition Forceps

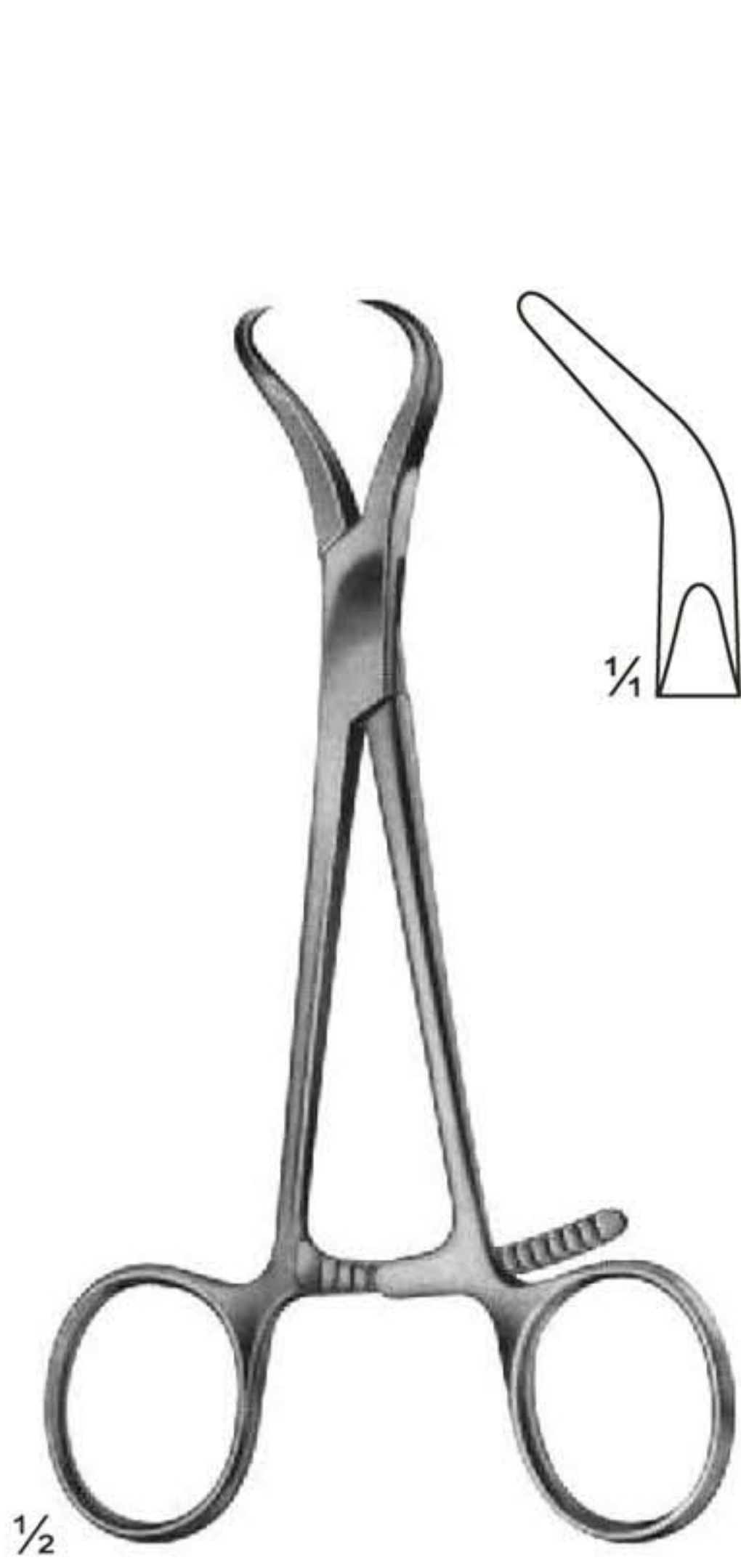

**22-101**  
Reposition forceps,  
for small fragments  
135 mm

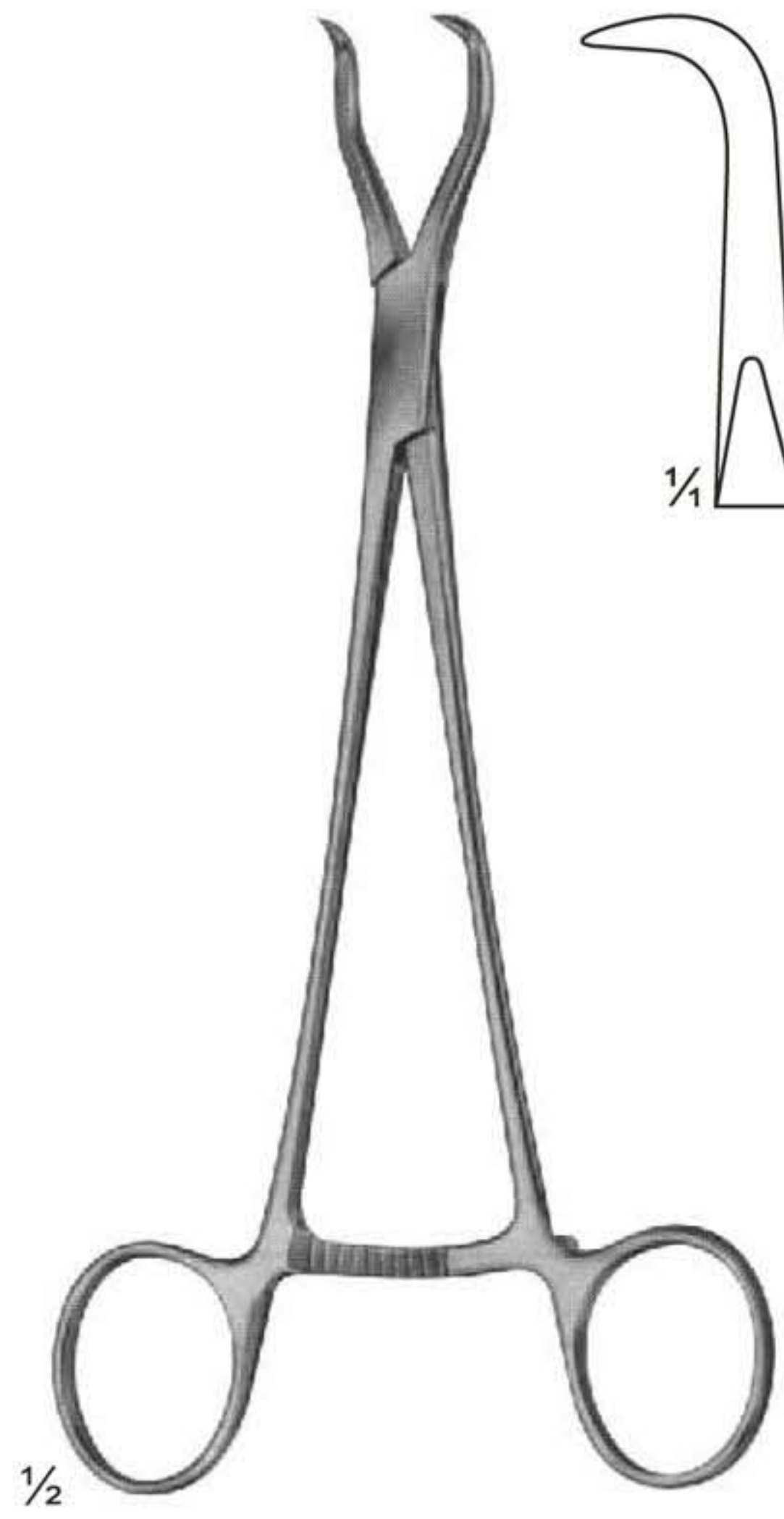

**HAASE**  
**22-102**  
Reposition forceps,  
for mandibular  
fractures  
165 mm

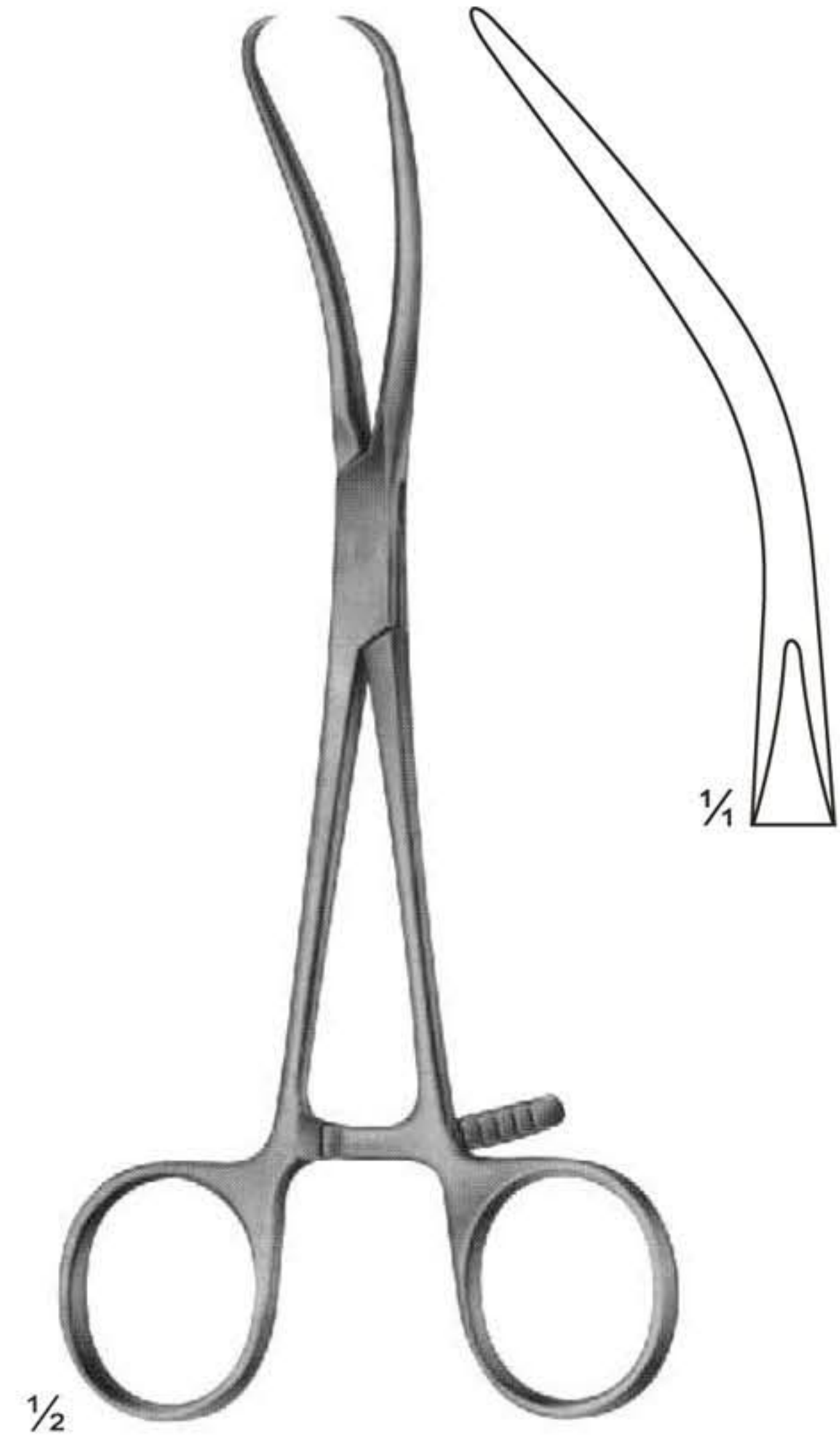

**REILL**  
**22-103**  
Reposition forceps,  
170 mm



**22-104**  
Reposition forceps  
205 mm

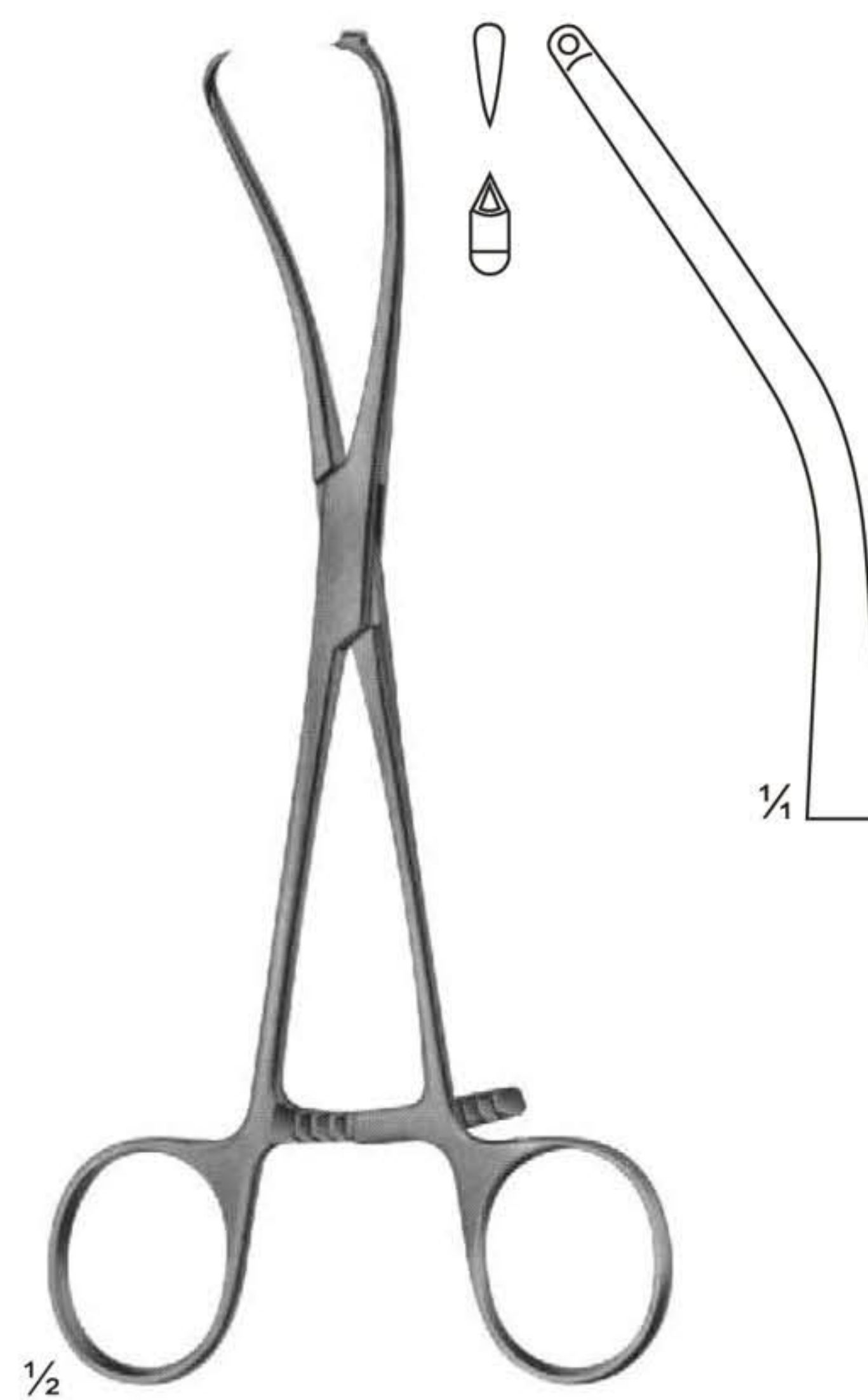
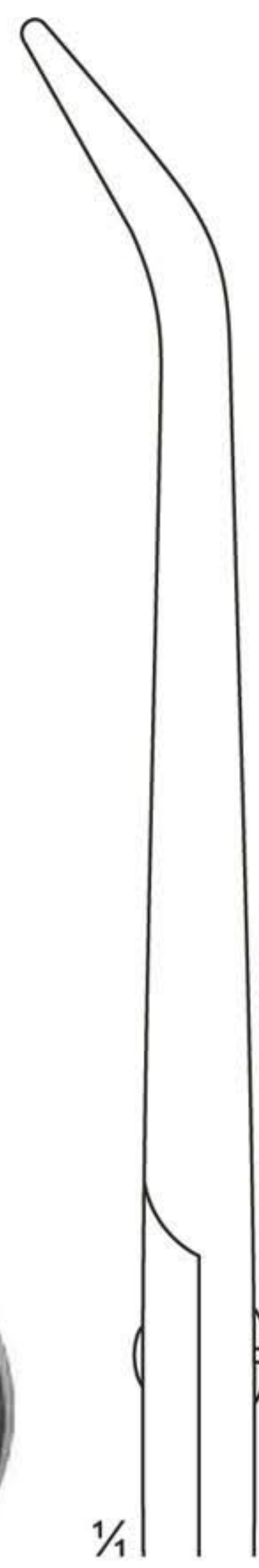

**MEYER**  
**22-105**  
Reposition forceps  
for fingers, with drill  
guide for KIRSCHNER  
wires up to diam. 1.0 mm  
170 mm



Reposition Forceps, Bone Holding Forceps



**22-106**  
Patella forceps  
185 mm



**22-107**  
Forceps with  
ratchet fixation  
140 mm



**22-108**  
Forceps with  
thread fixation  
170 mm



**22-109**  
Forceps with  
thread fixation  
235 mm

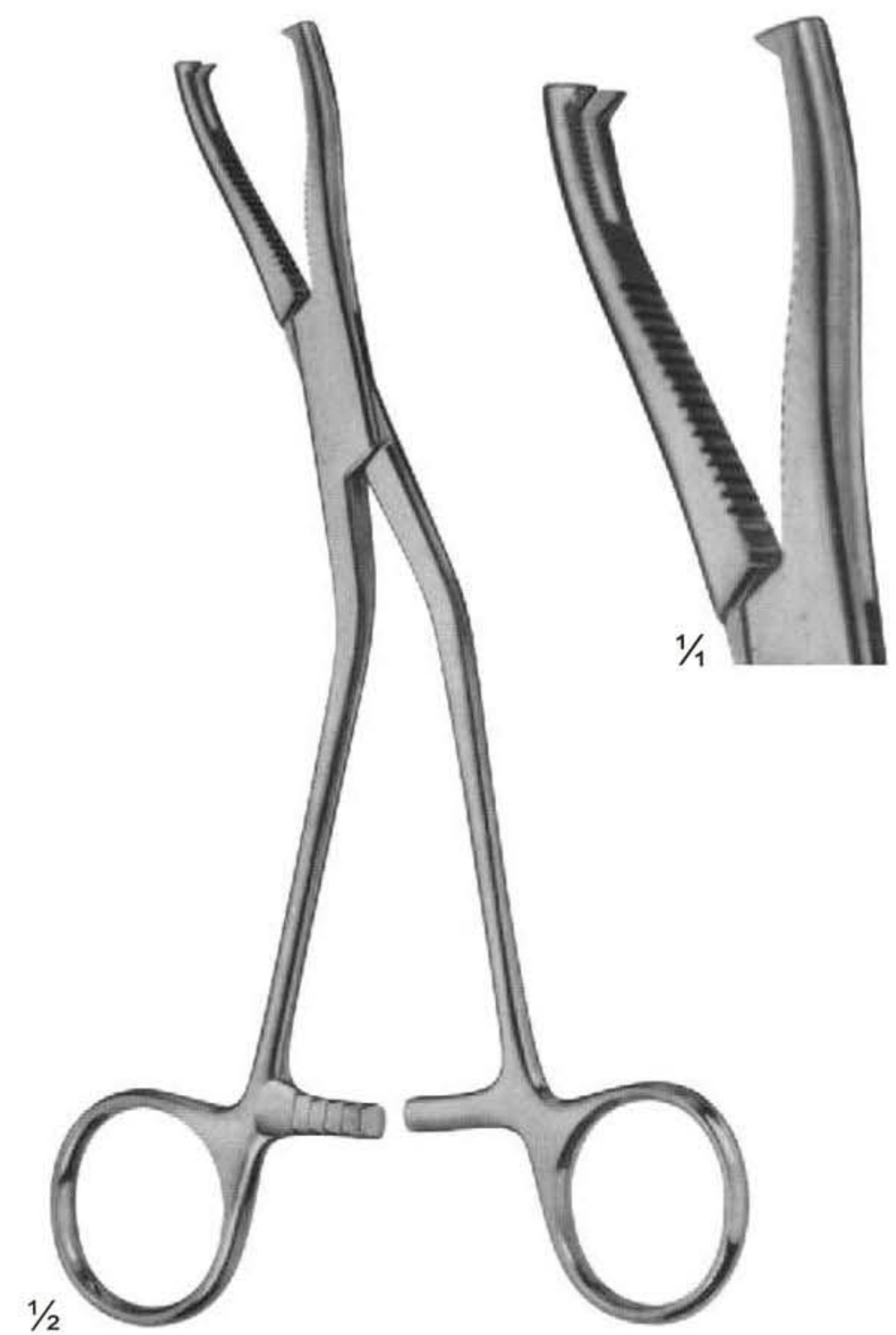

**22-110**  
DINGMANN  
185 mm



**Bone Holding Forceps**



**22-111**  
Sequestrum  
forceps  
200 mm



**22-112**  
VAN BUREN  
Sequestrum  
forceps  
225 mm



**22-113**  
LANGENBECK  
Sequestrum  
forceps  
205 mm



**22-114**  
FERGUSON  
205 mm



**Bone Holding Forceps**

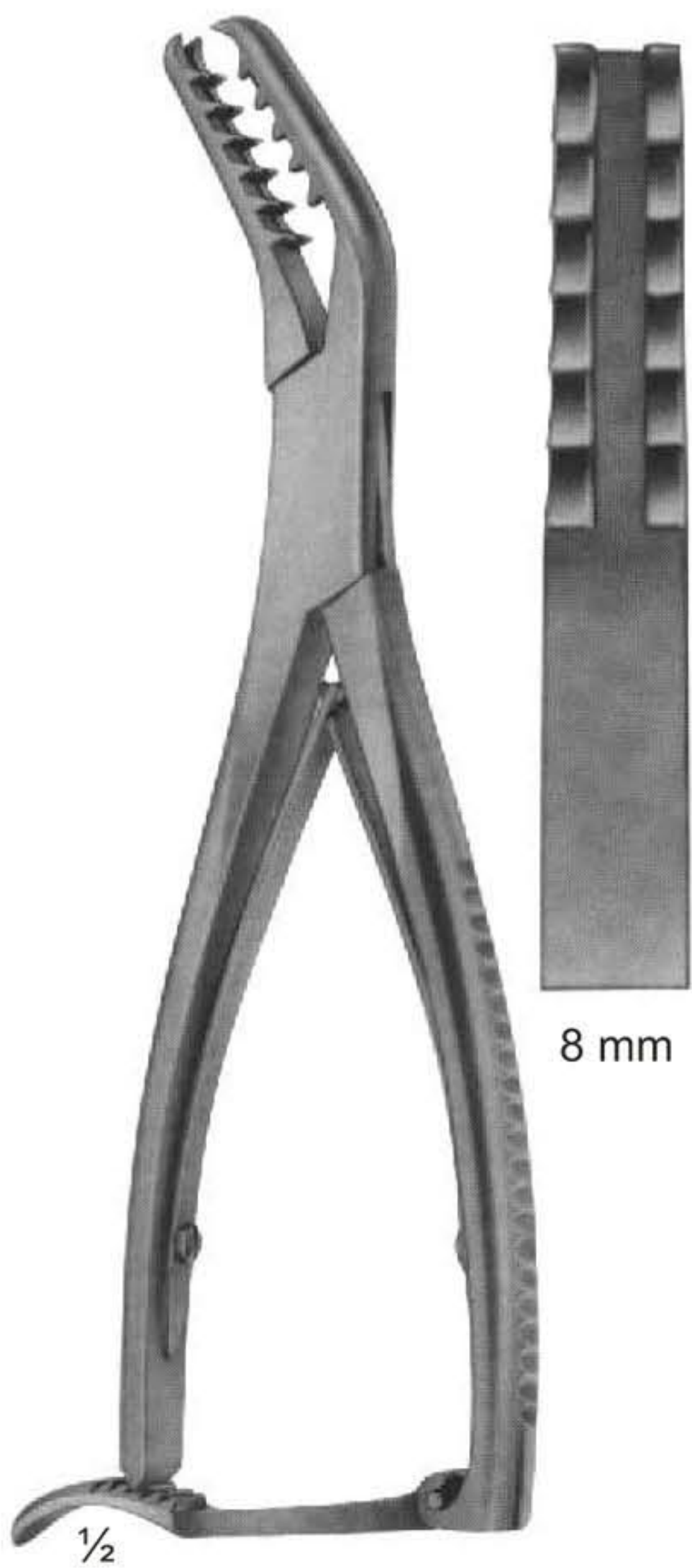
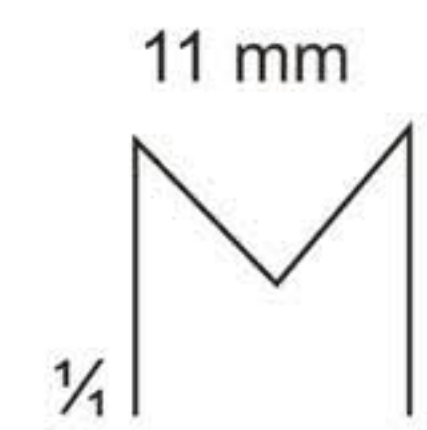
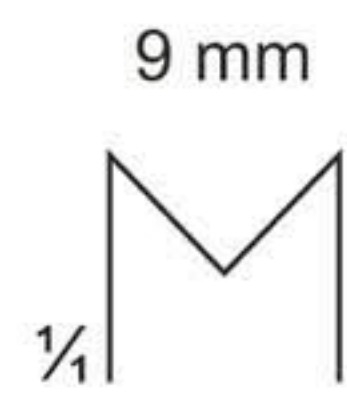
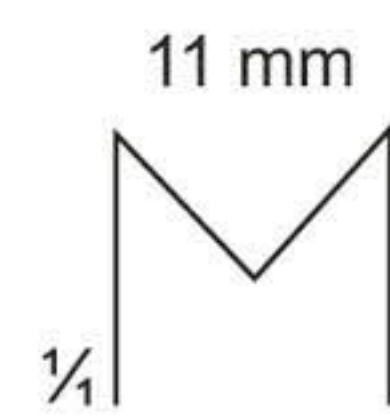
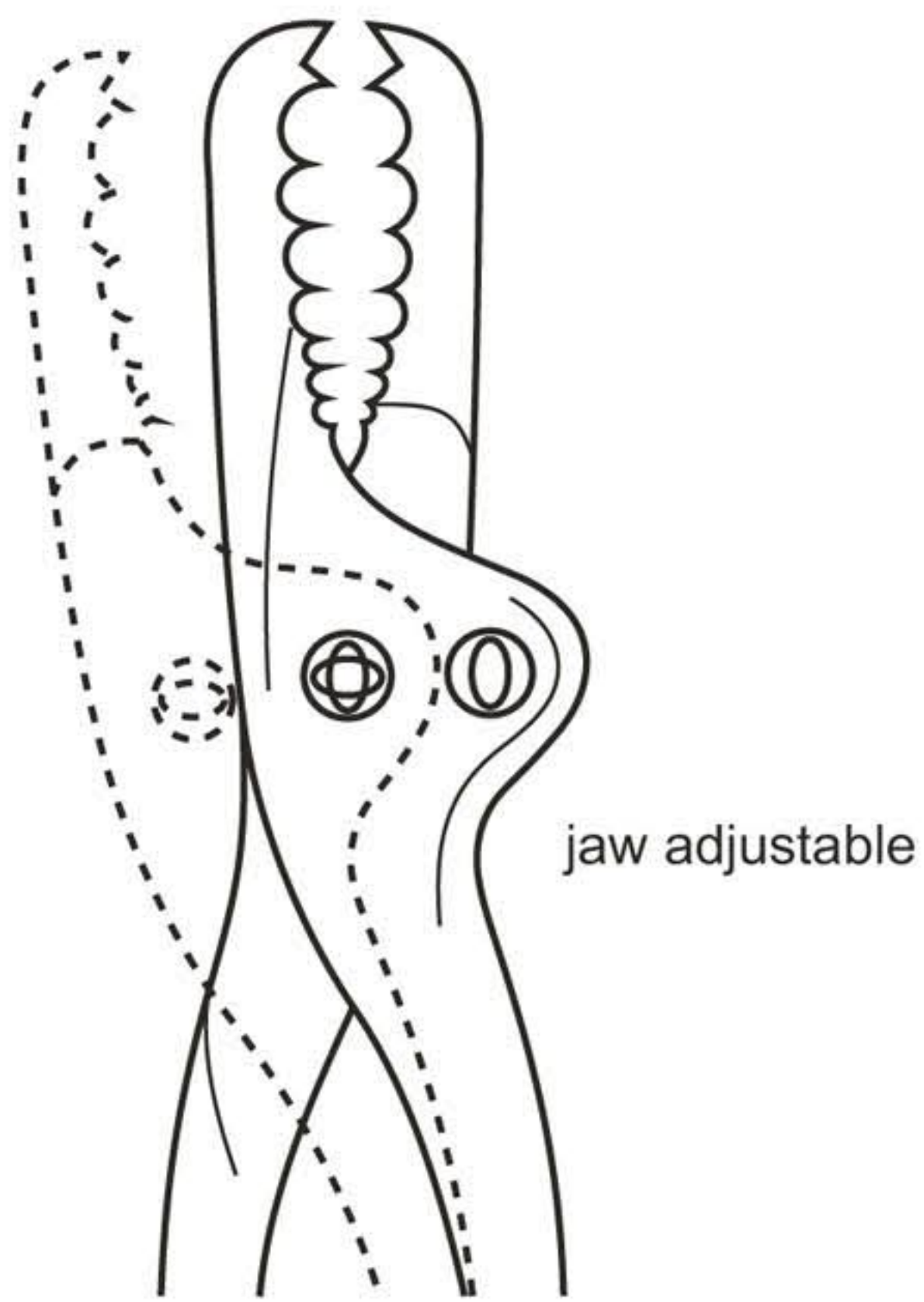

**22-115**  
SEMB  
190 mm



**22-116**  
FARABEUF  
230 mm

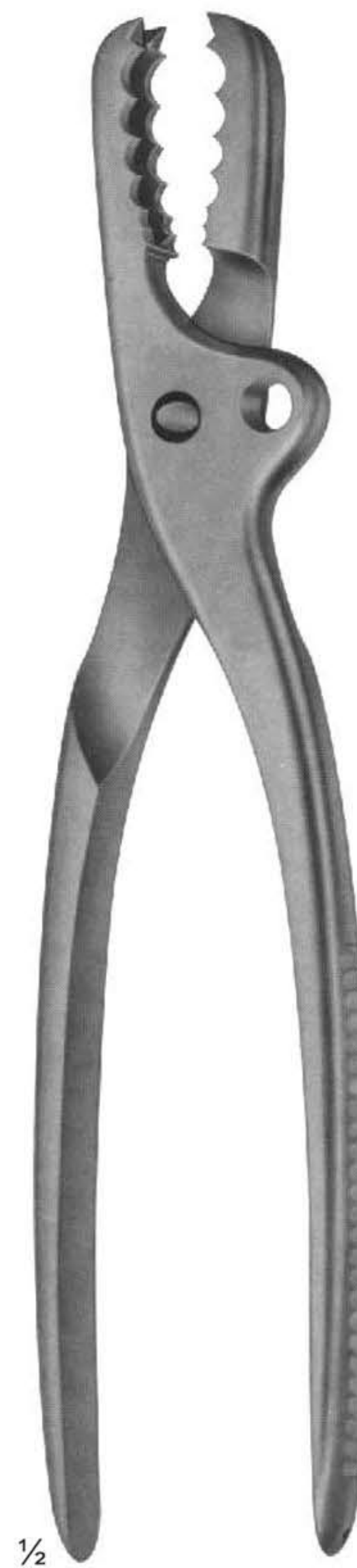

**22-117**  
FARABEUF  
255 mm



**22-118**  
FARABEUF-LAMBOTTE  
255 mm



# Bone Holding Forceps

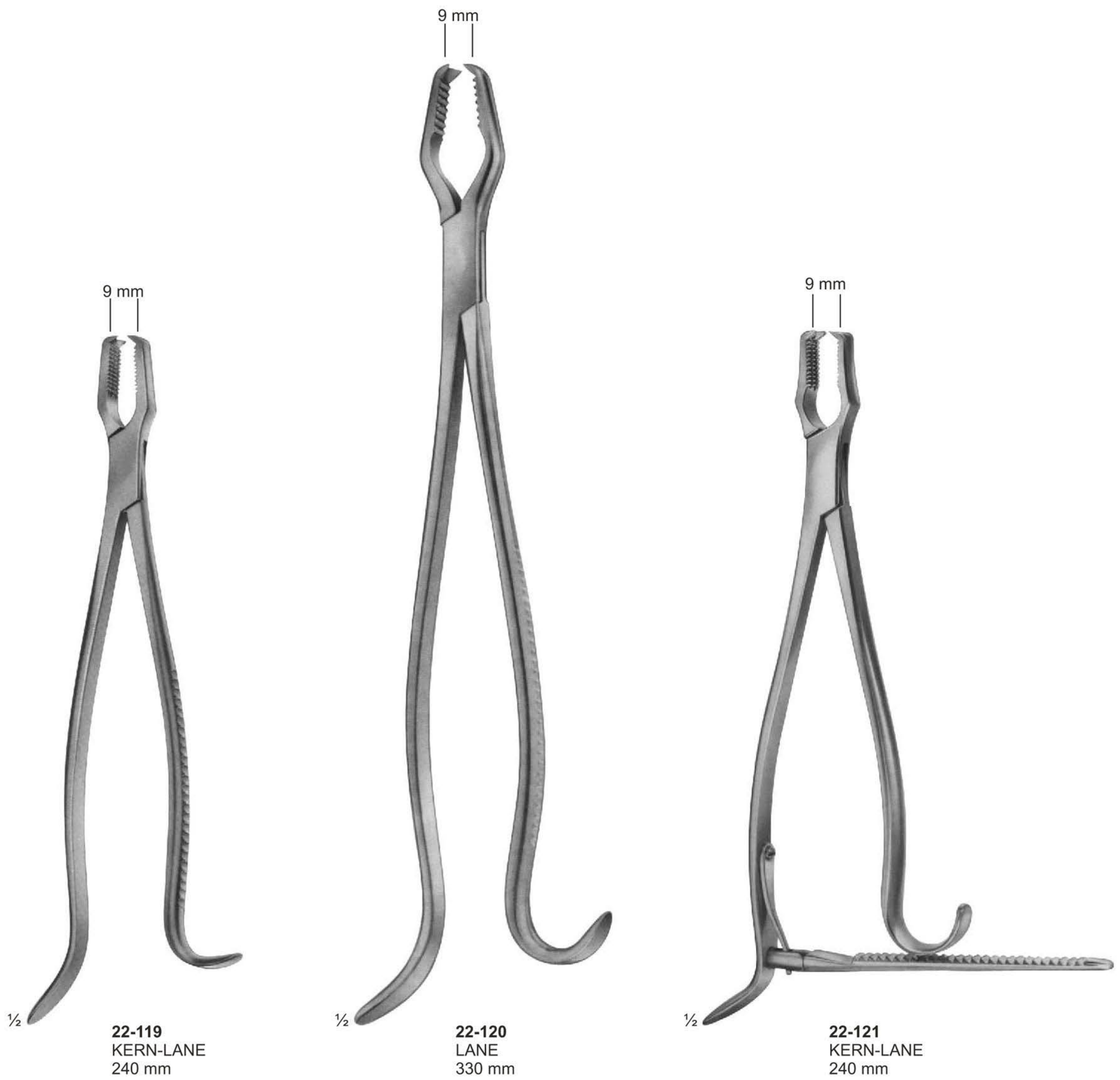



## Bone Holding Forceps





# Bone Holding Forceps

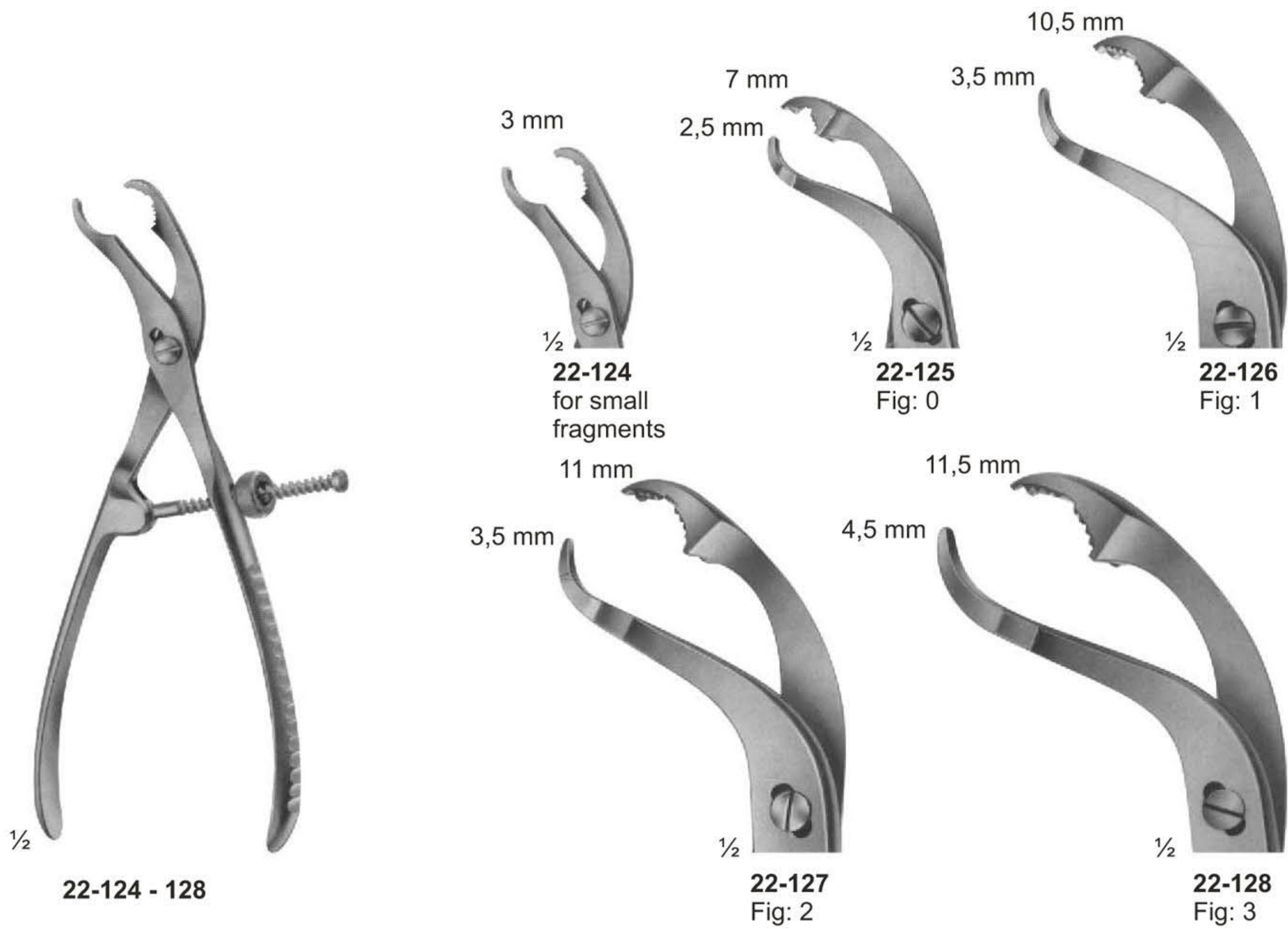

**22-124 - 128**

- 22-124 145 mm
- 22-125 190 mm
- 22-126 240 mm
- 22-127 260 mm
- 22-128 280 mm

Self-centering forceps  
with thread fixation



**22-129 - 131** 255 mm  
VERBRUGGE 265 mm  
with lip joint 270 mm

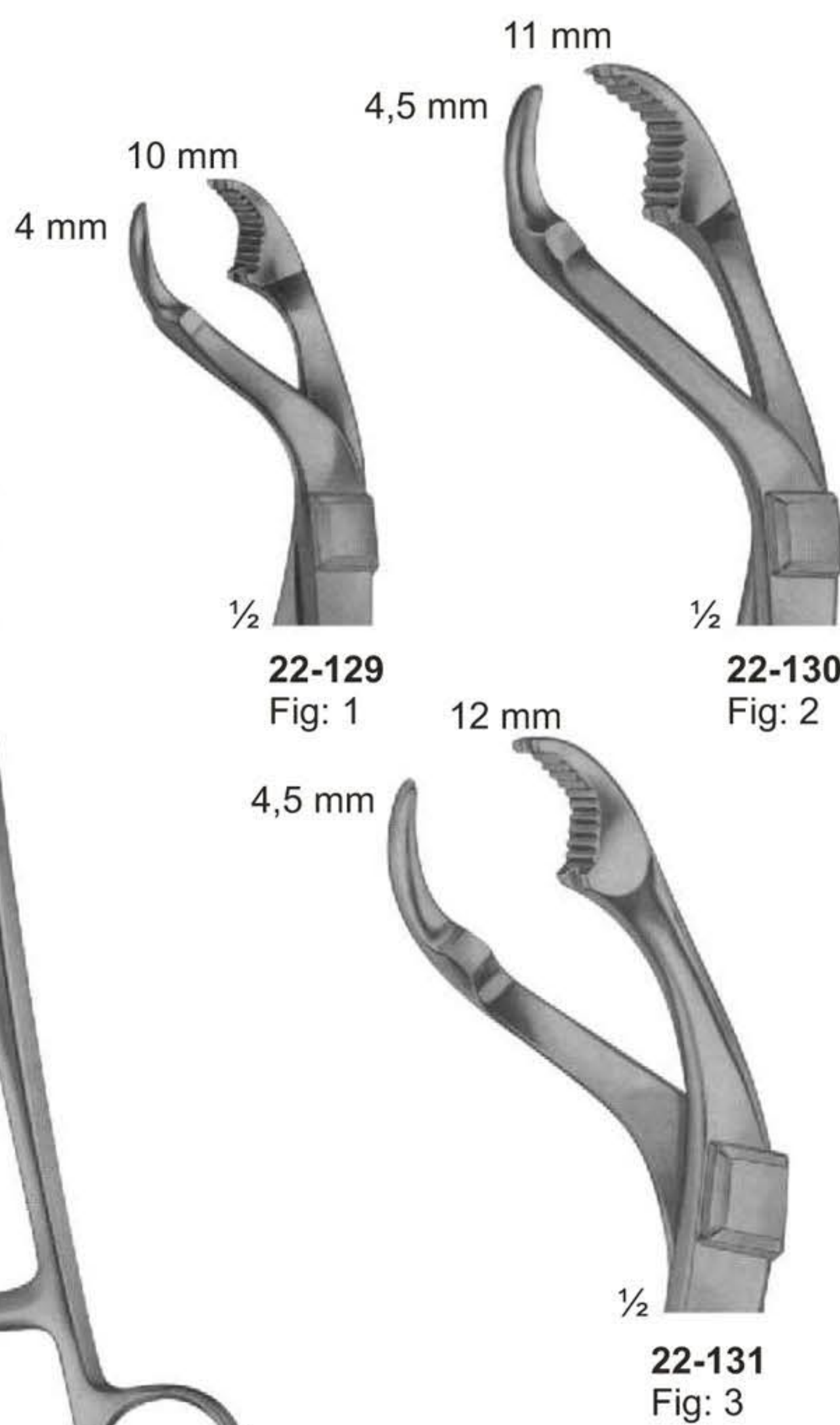

**22-129**  
Fig: 1

**22-130**  
Fig: 2

**22-131**  
Fig: 3



**22-132**  
LAMBOTTE  
265 mm



## Bone Clamps



**22-133 - 134**  
LOWMAN  
22-133 170 mm  
22-134 205 mm



**22-135**  
LOWMAN-GERSTER  
210 mm



**22-136**  
LOWMAN-HOGLUND  
175 mm



**Synovectomy-Rongeurs, Bone Rongeurs**

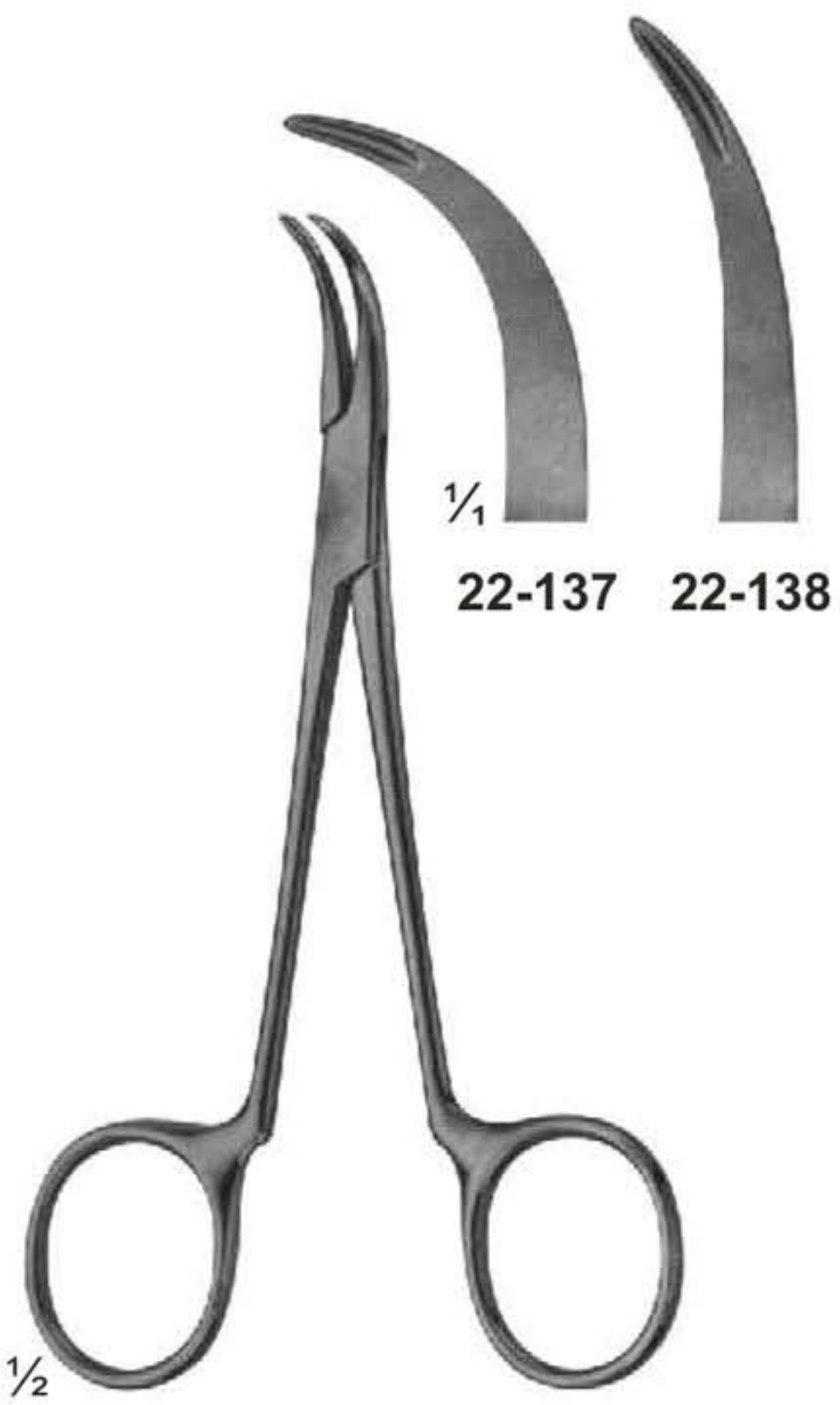

**22-137 - 138**  
Synovectomy rongeur  
width of jaws 1.2 mm  
130 mm

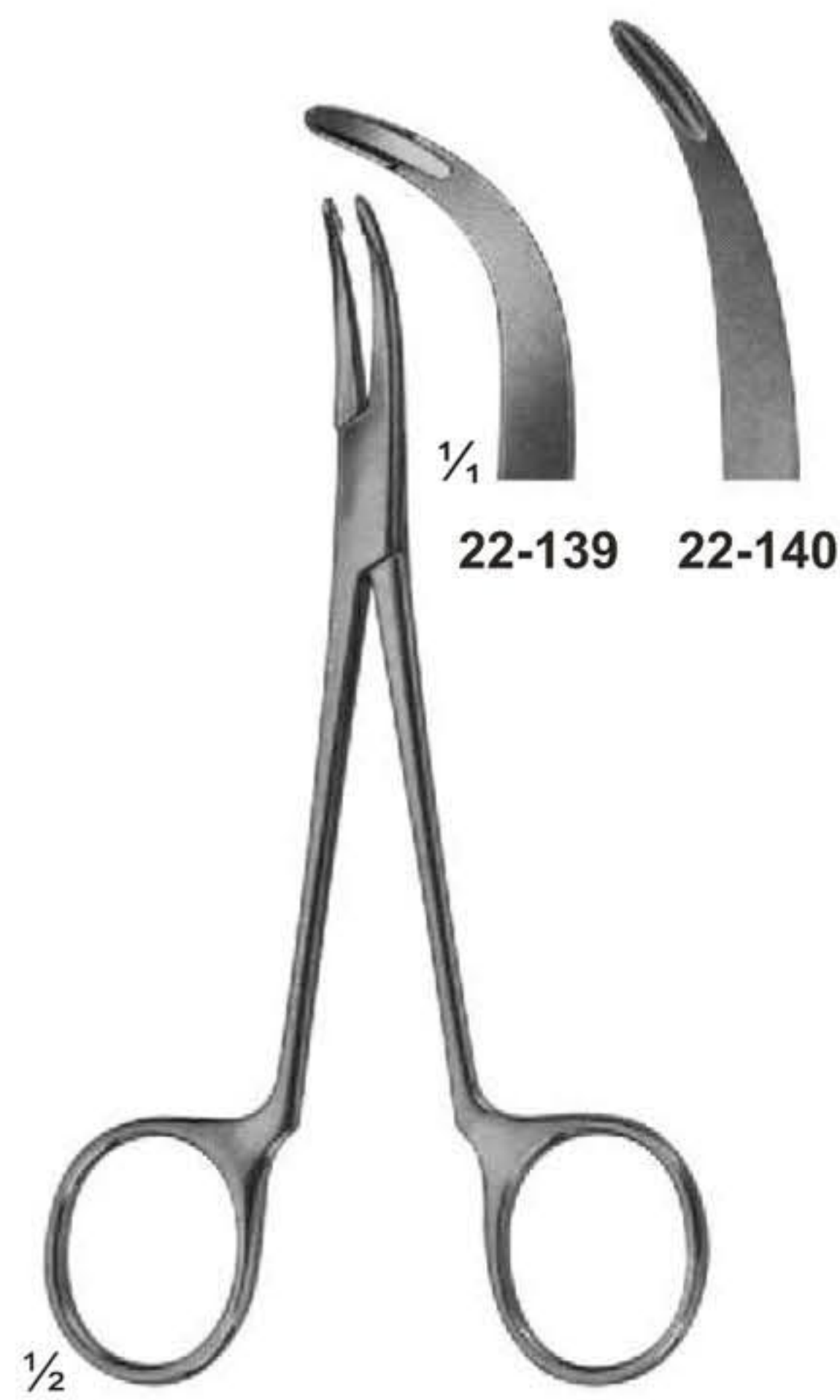

**22-139 - 140**  
Synovectomy rongeur  
width of jaws 2.0 mm  
130 mm

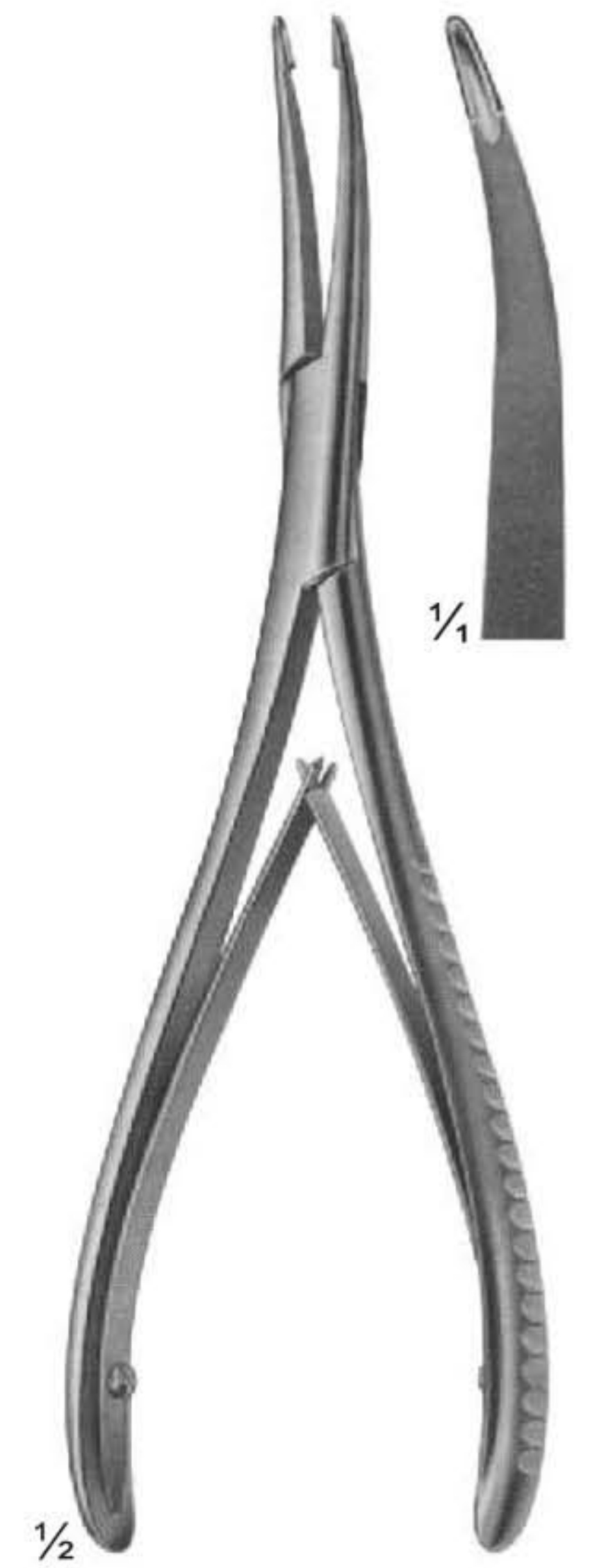

**22-141**  
STELLBRINK  
Synovectomy rongeur  
175 mm

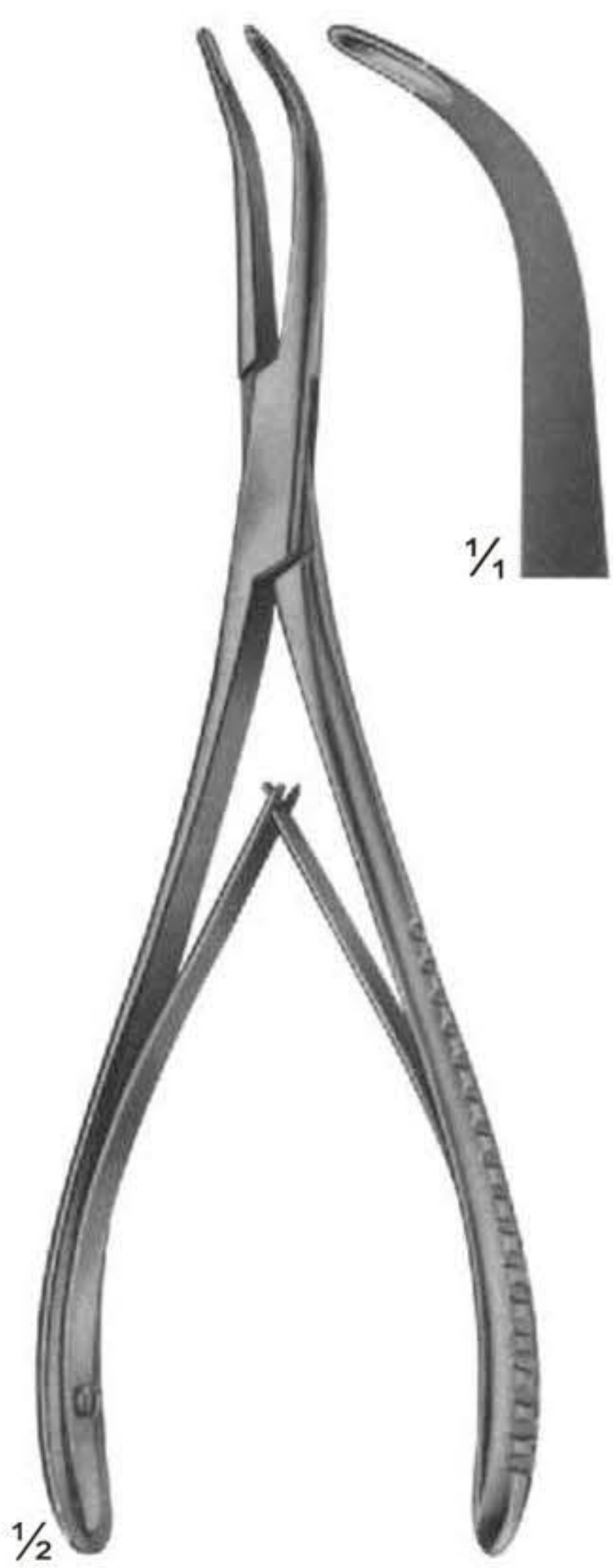

**22-142**  
STELLBRINK  
Synovectomy rongeur  
170 mm



**22-143**  
LURE-FRIEDMANN  
145 mm

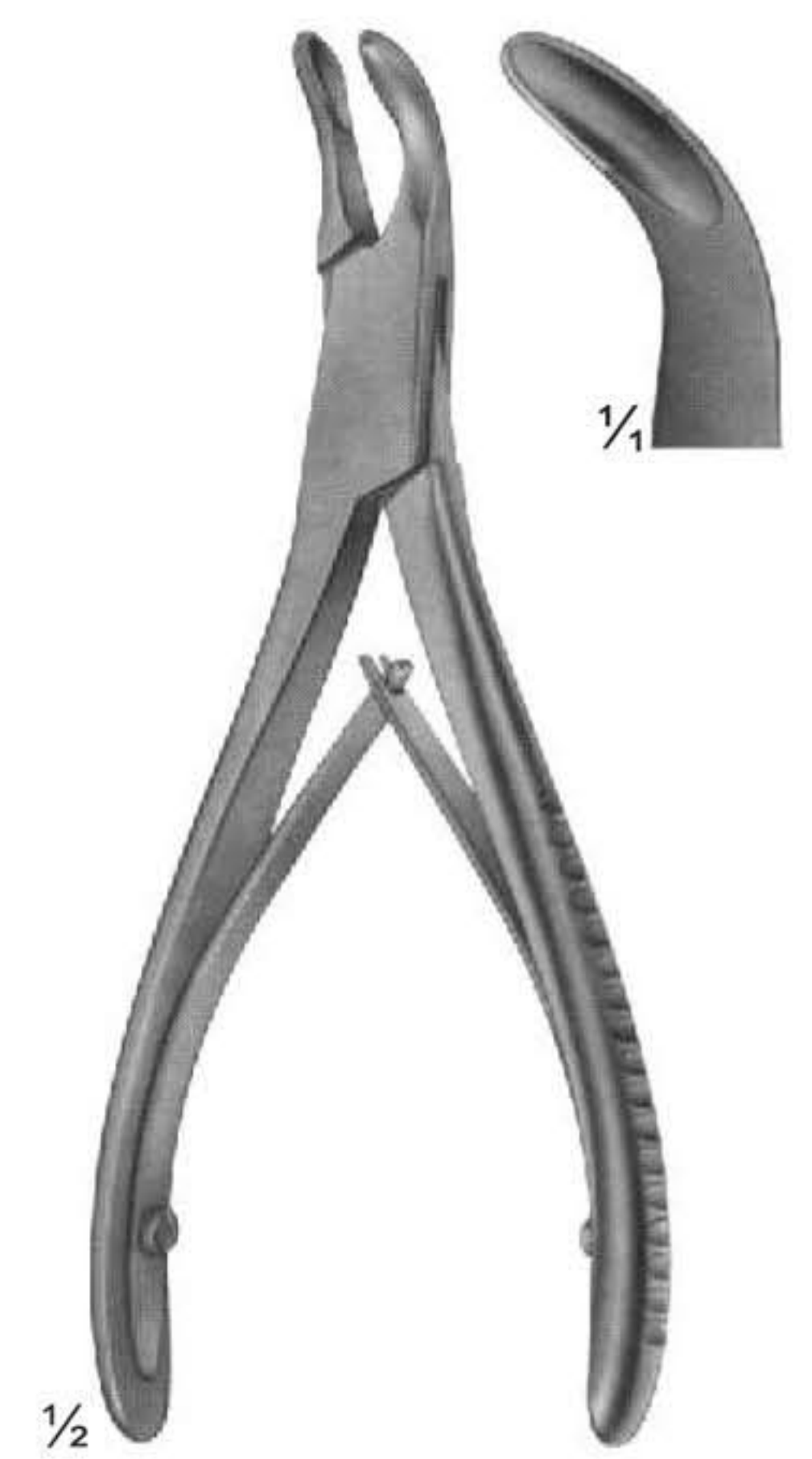

**22-144**  
140 mm



**Bone Rongeurs**



**22-145**  
LURE  
150 mm

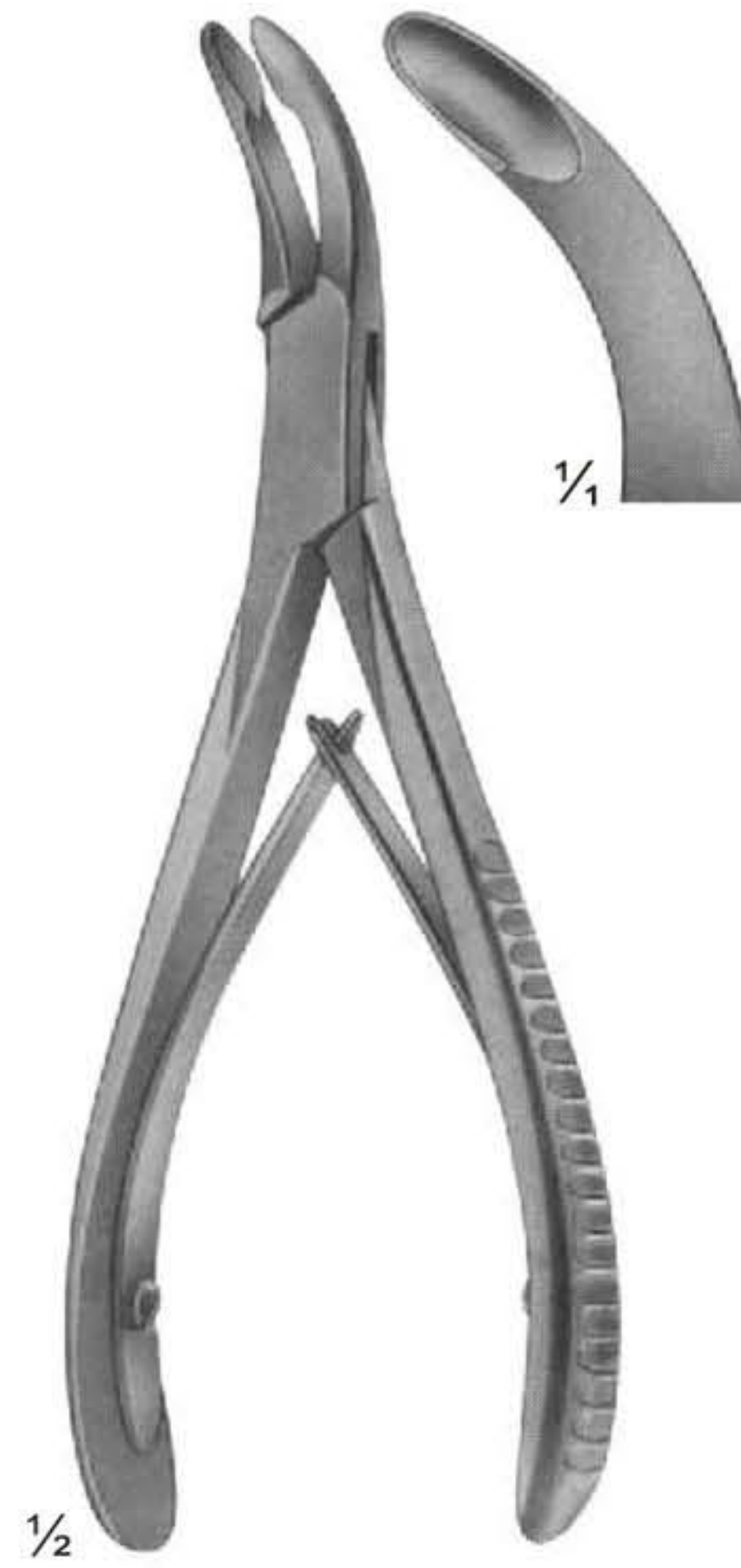

**22-146**  
LURE  
155 mm

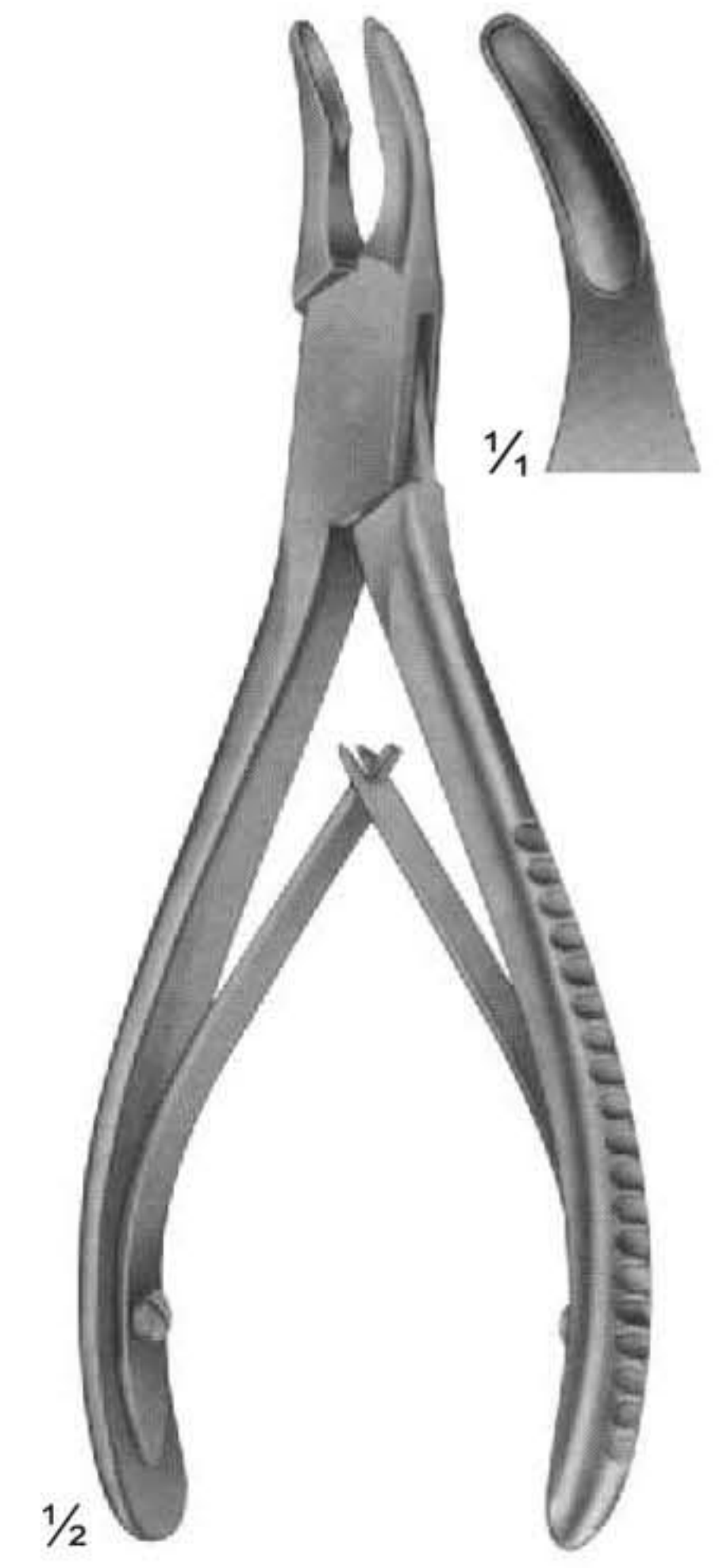

**22-147**  
BLUMENTHAL  
155 mm

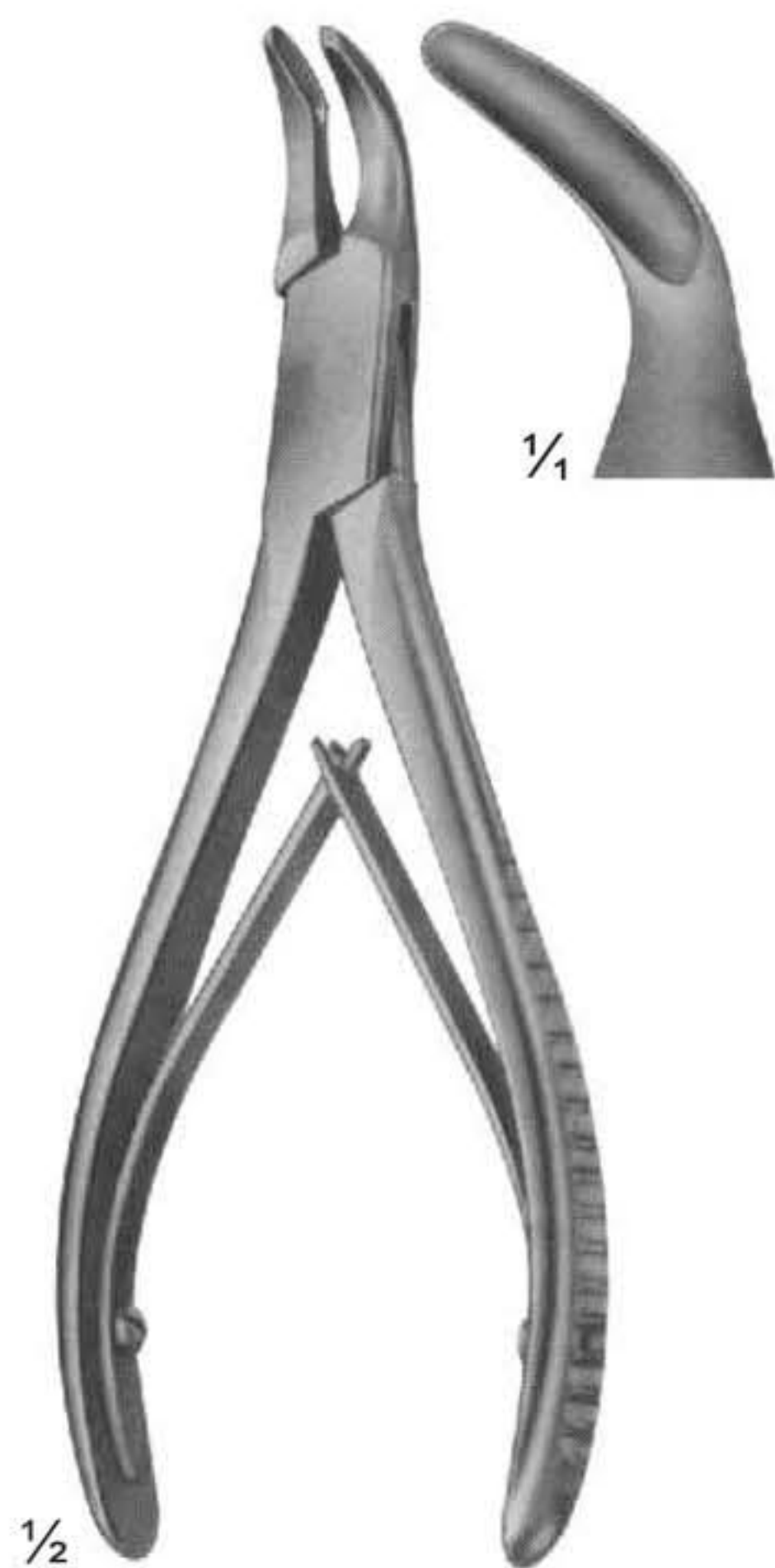

**22-148**  
BLUMENTHAL  
150 mm

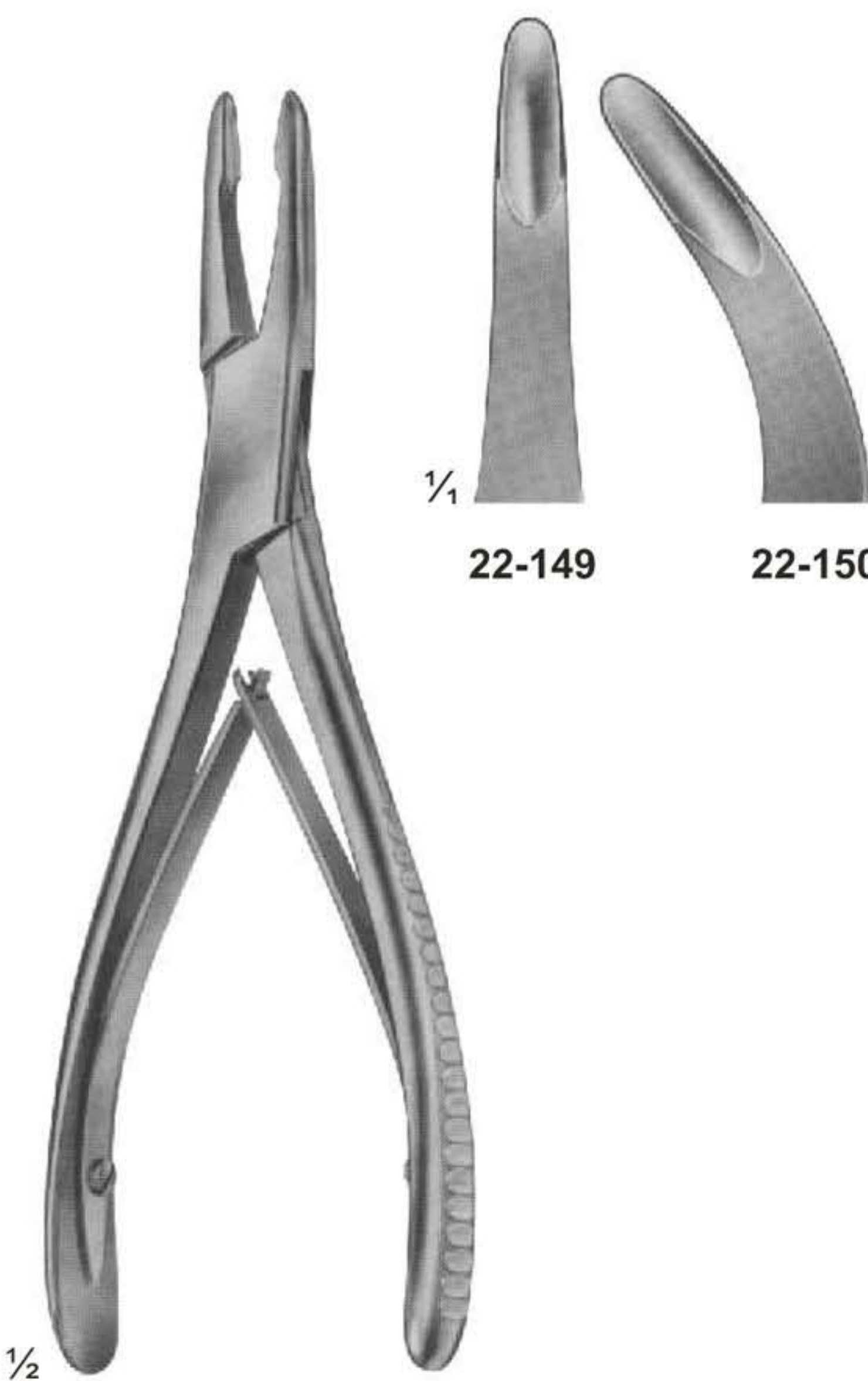

**22-149 - 150**  
JANSEN  
175 mm

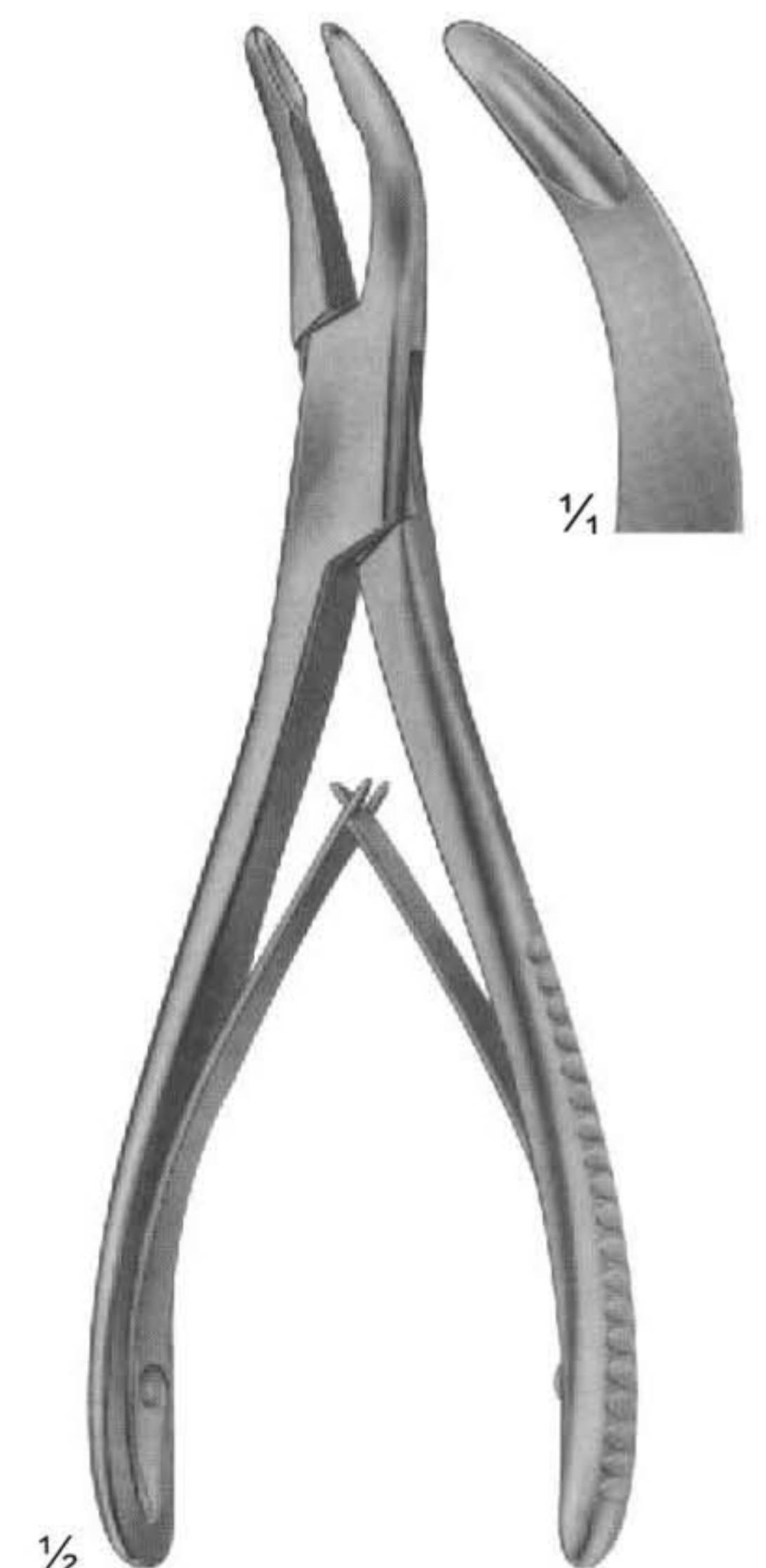

**22-151**  
BANE-HARTMANN  
175 mm



**Bone Rongeurs**

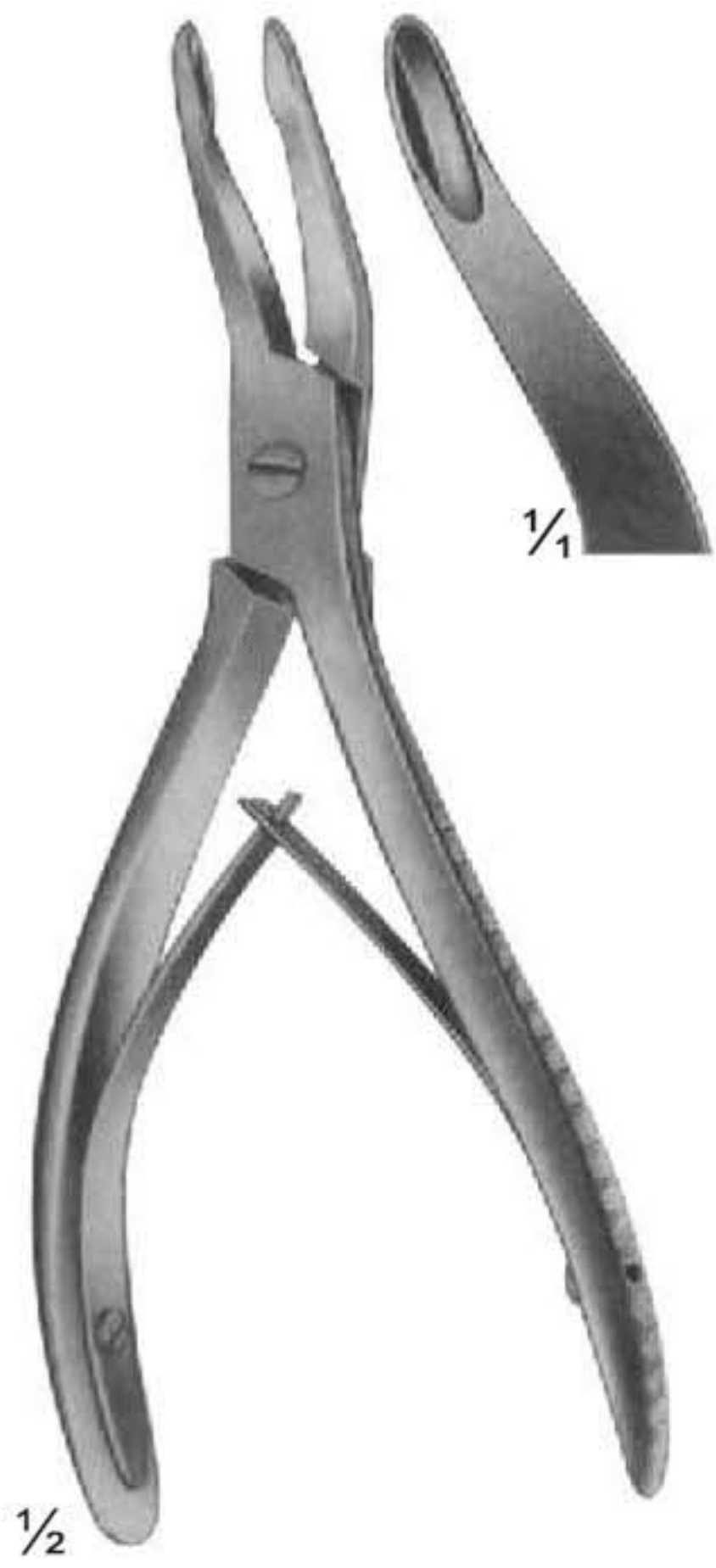

1/2  
**22-152**  
ALEXANDER  
140 mm

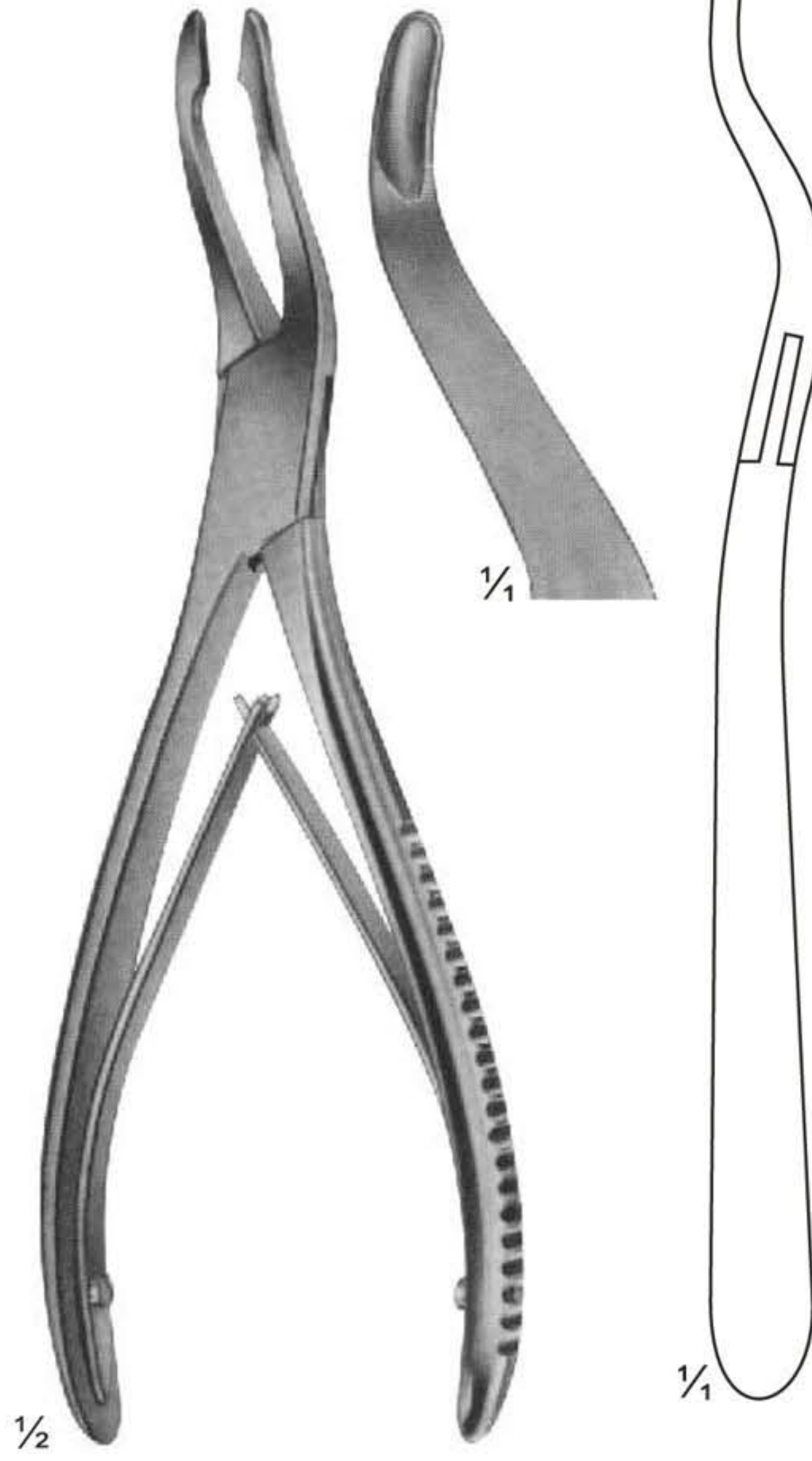

1/2  
**22-153**  
JANSEN  
190 mm

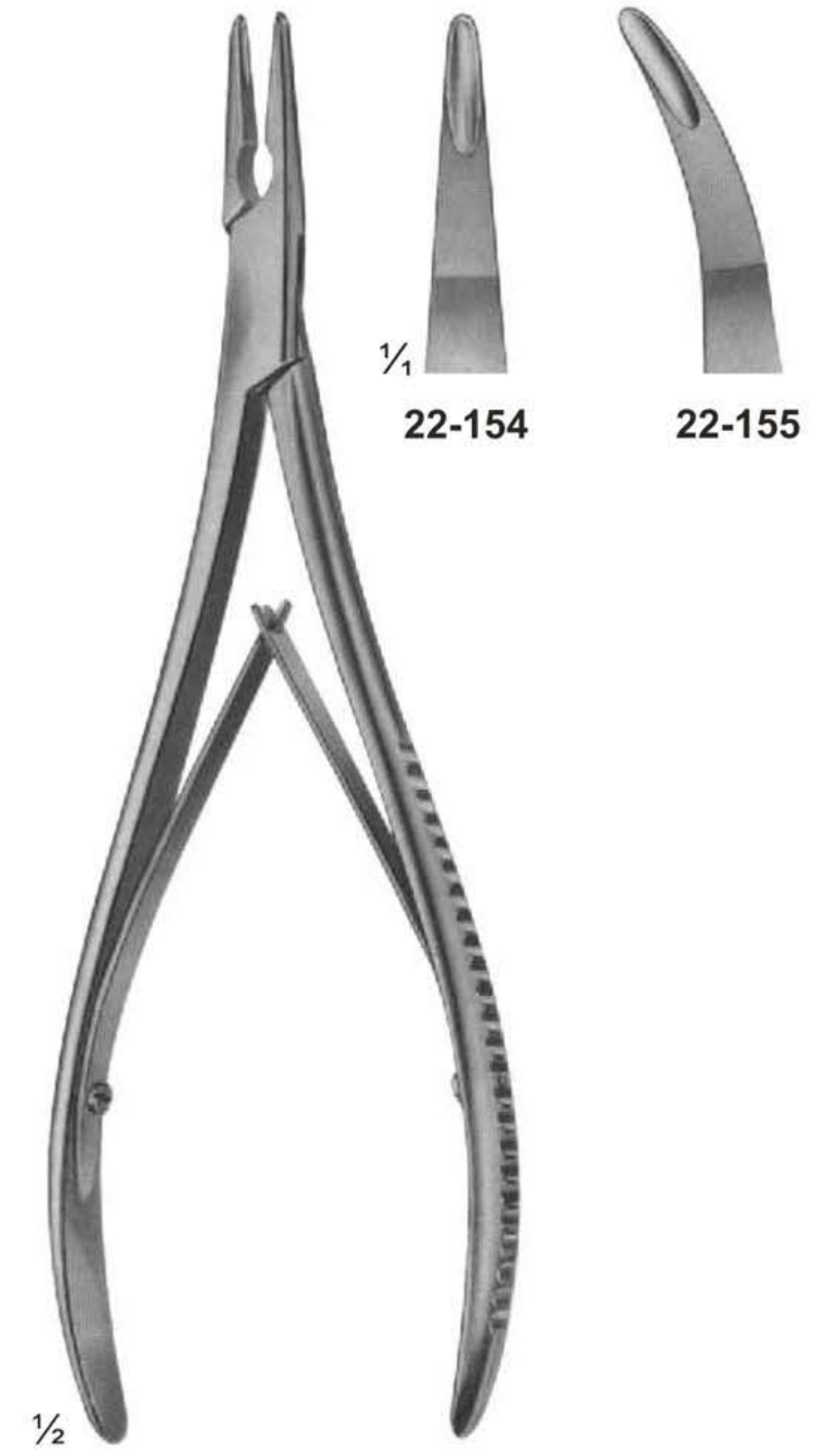

1/2  
**22-154 - 155**  
LEMPERT  
200 mm

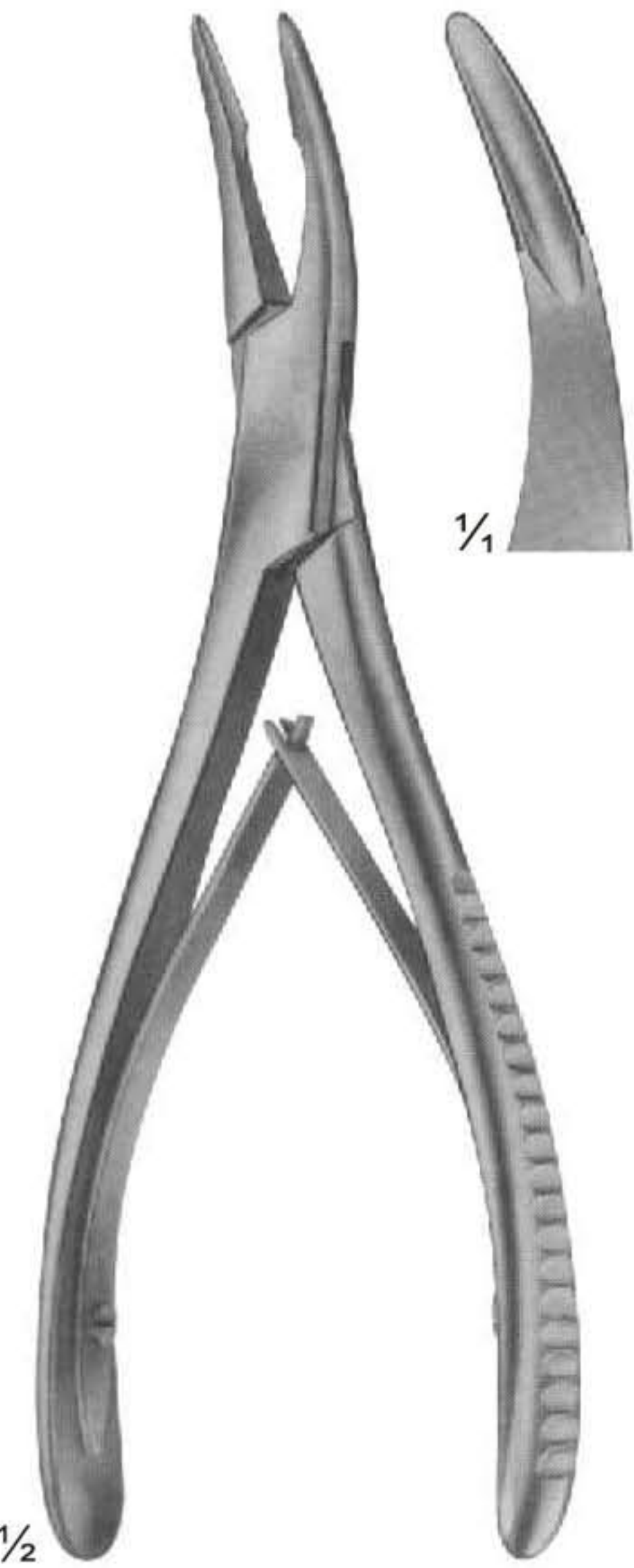

1/2  
**22-156**  
BEYER  
180 mm

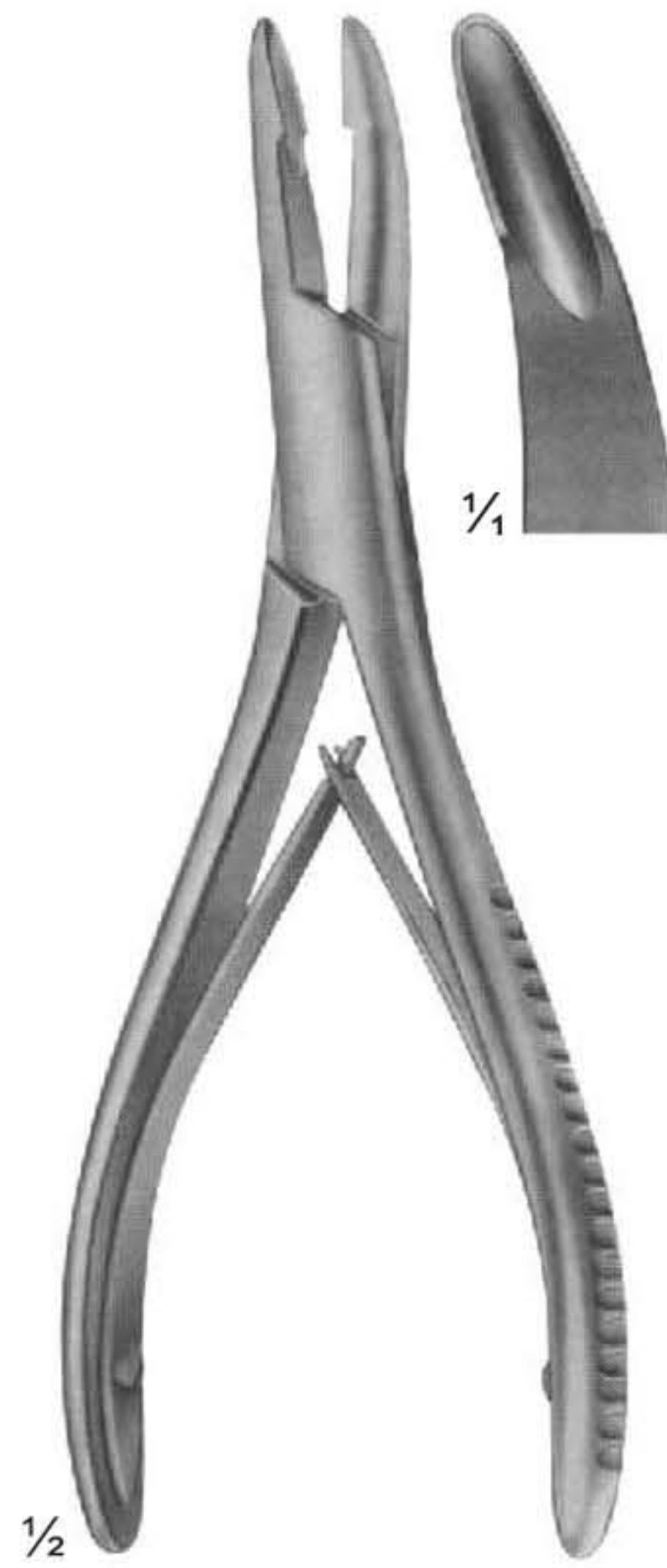

1/2  
**22-157**  
MEAD  
165 mm

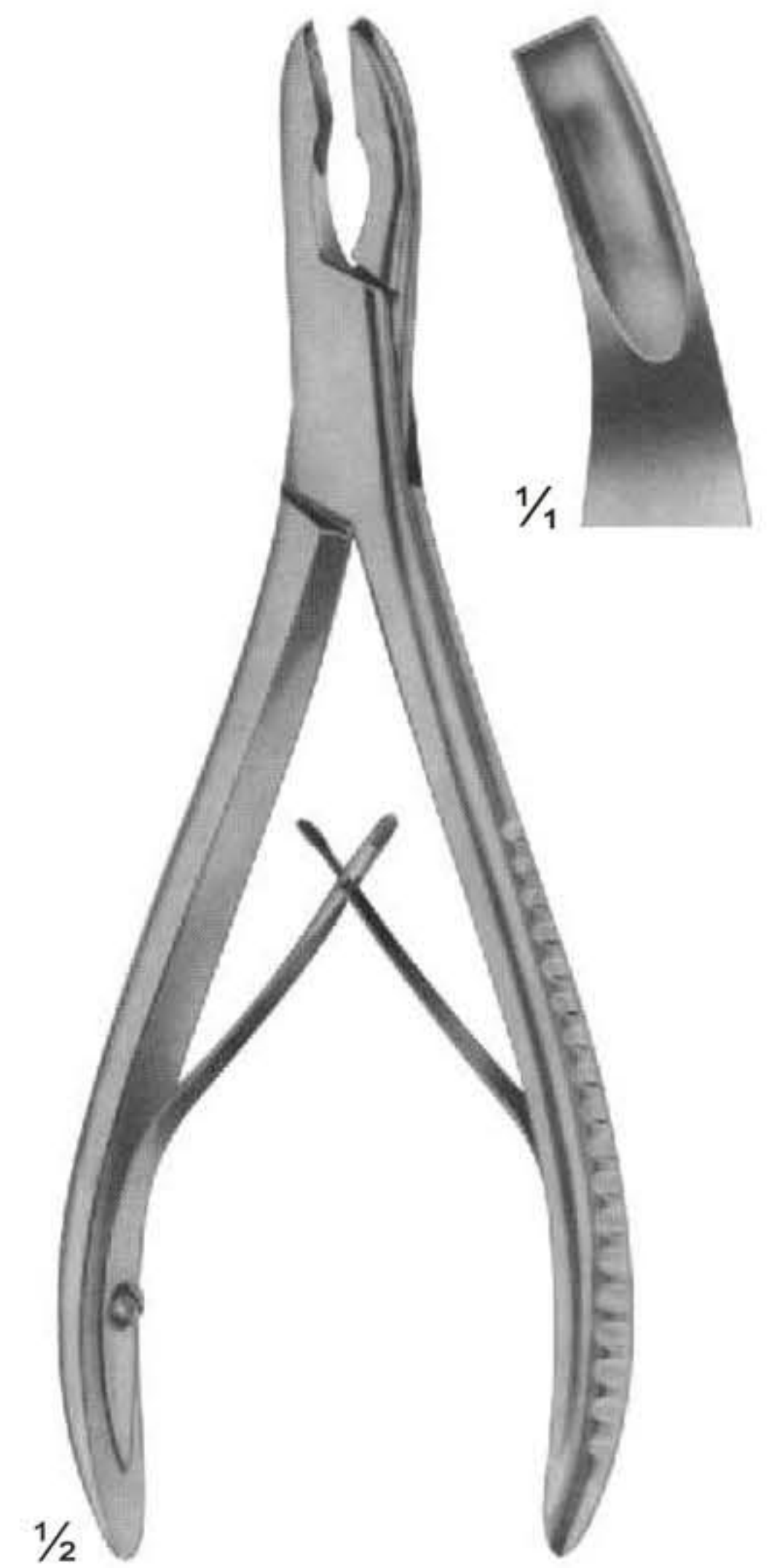

1/2  
**22-158**  
MEAD  
165 mm



**Bone Rongeurs**

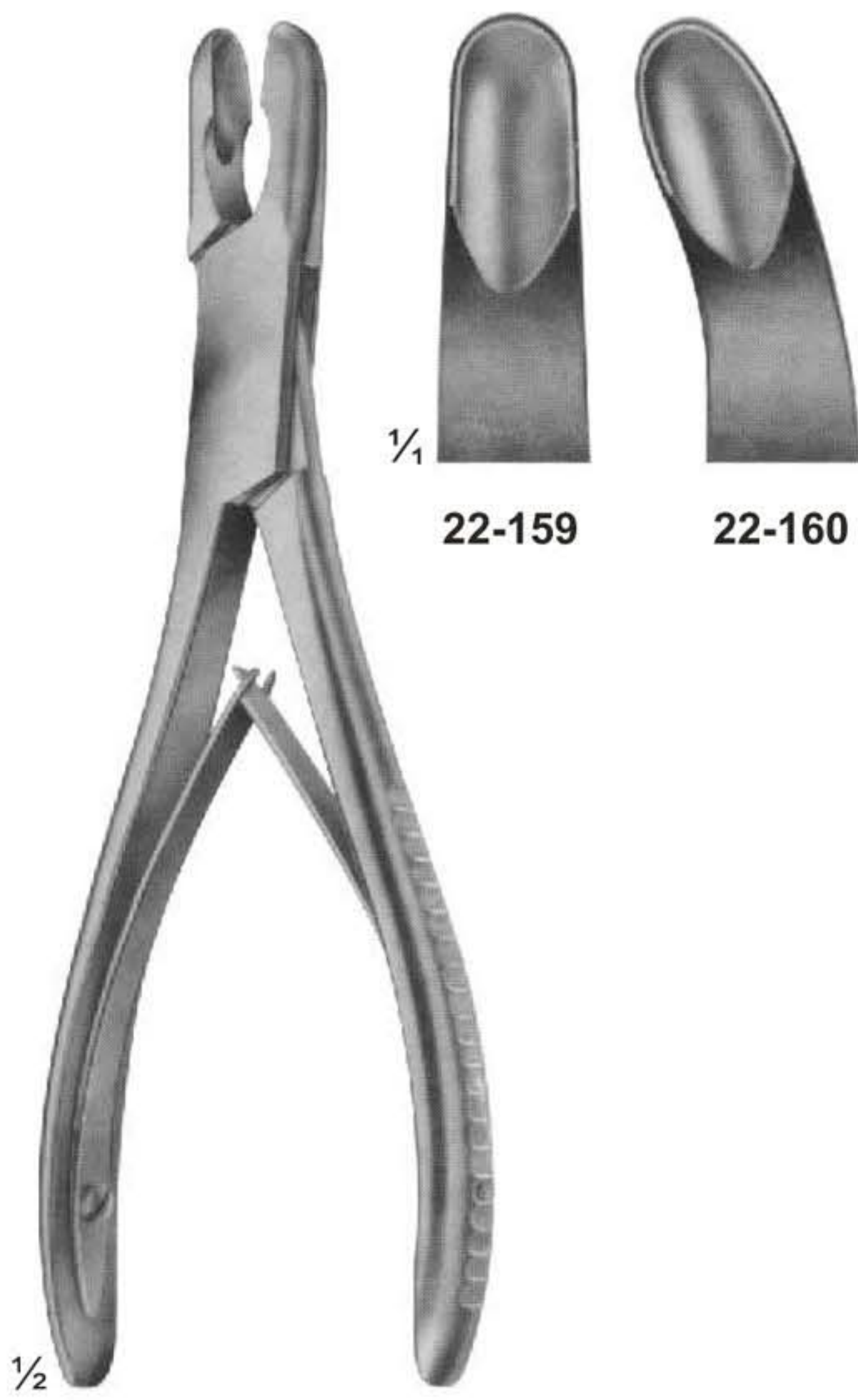

22-159      22-160

**22-159 - 160**  
LURE  
175 mm

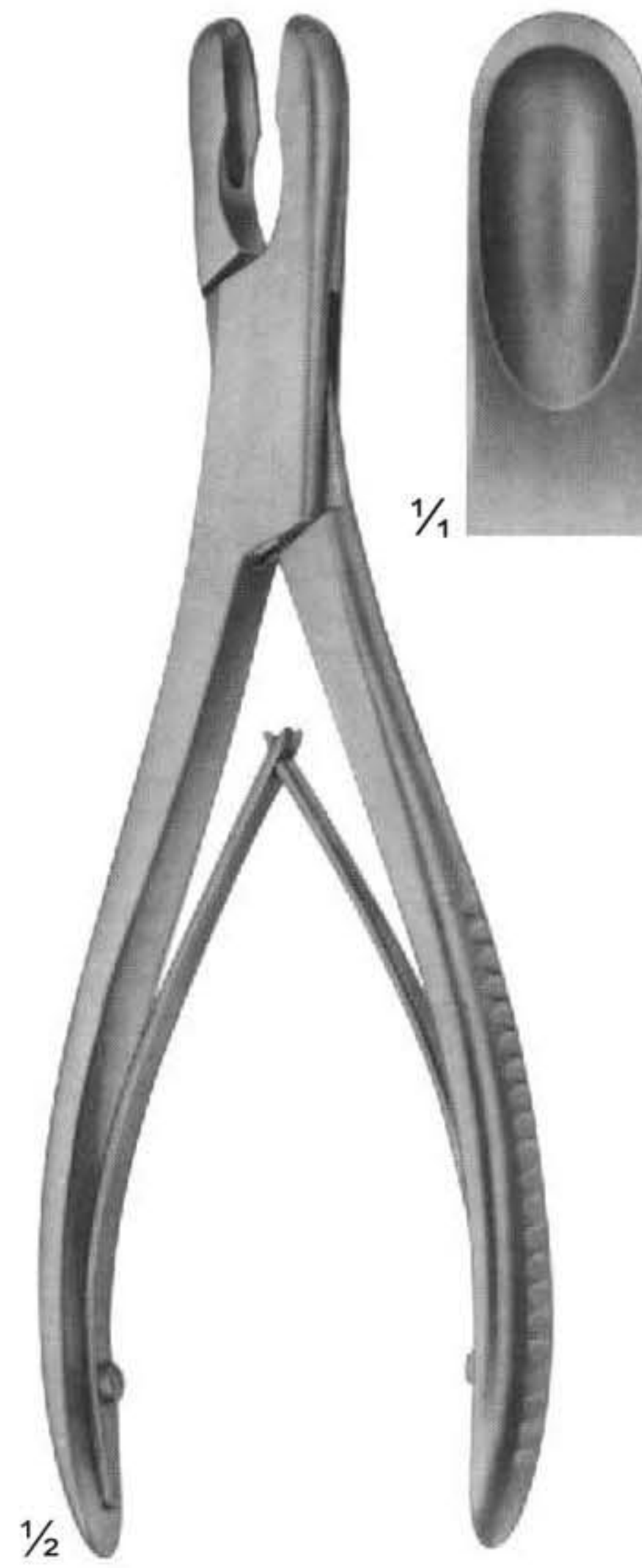

**22-161**  
LURE  
180 mm

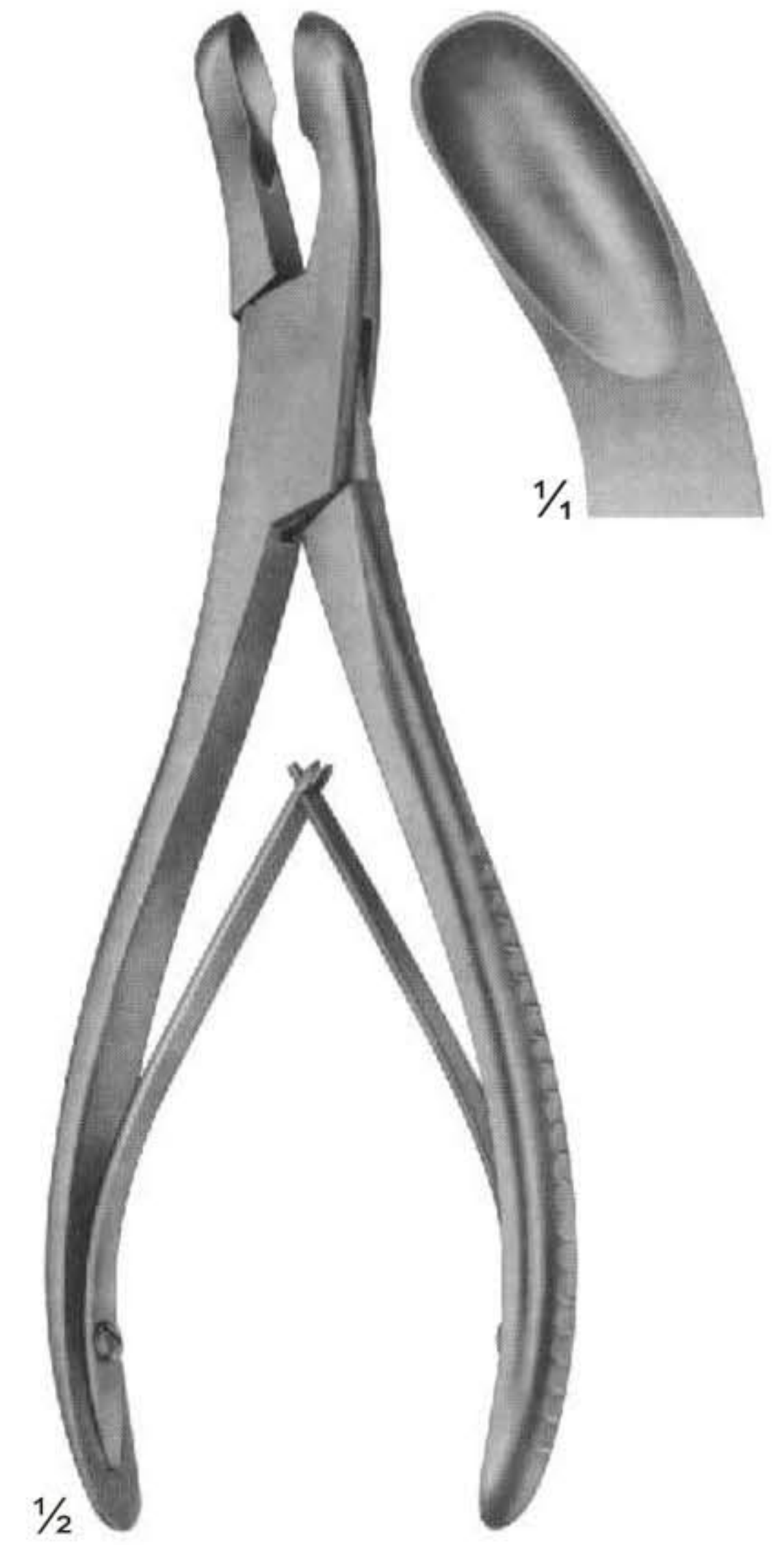

**22-162**  
LURE  
180 mm

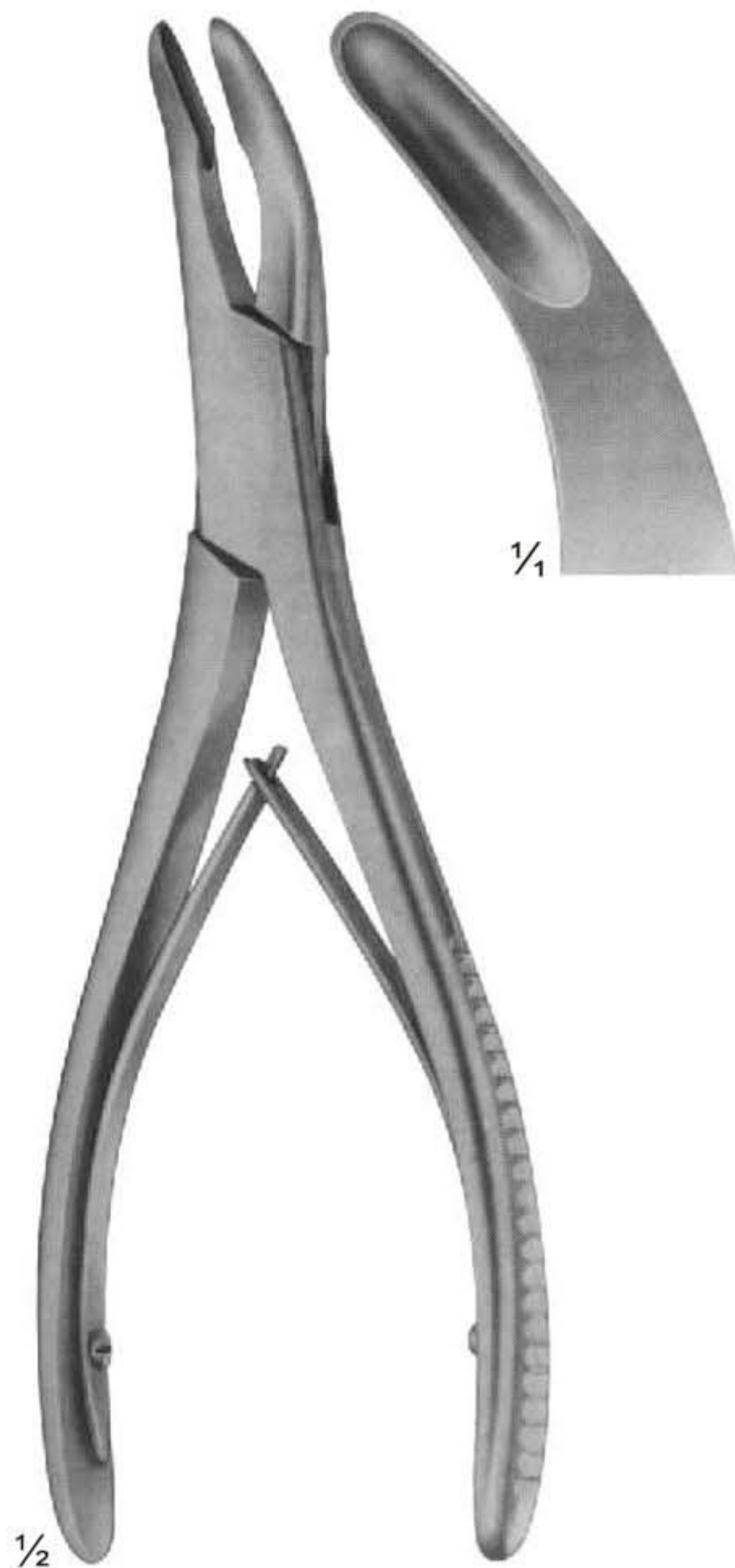

**22-163**  
OLIVECRONA  
205 mm

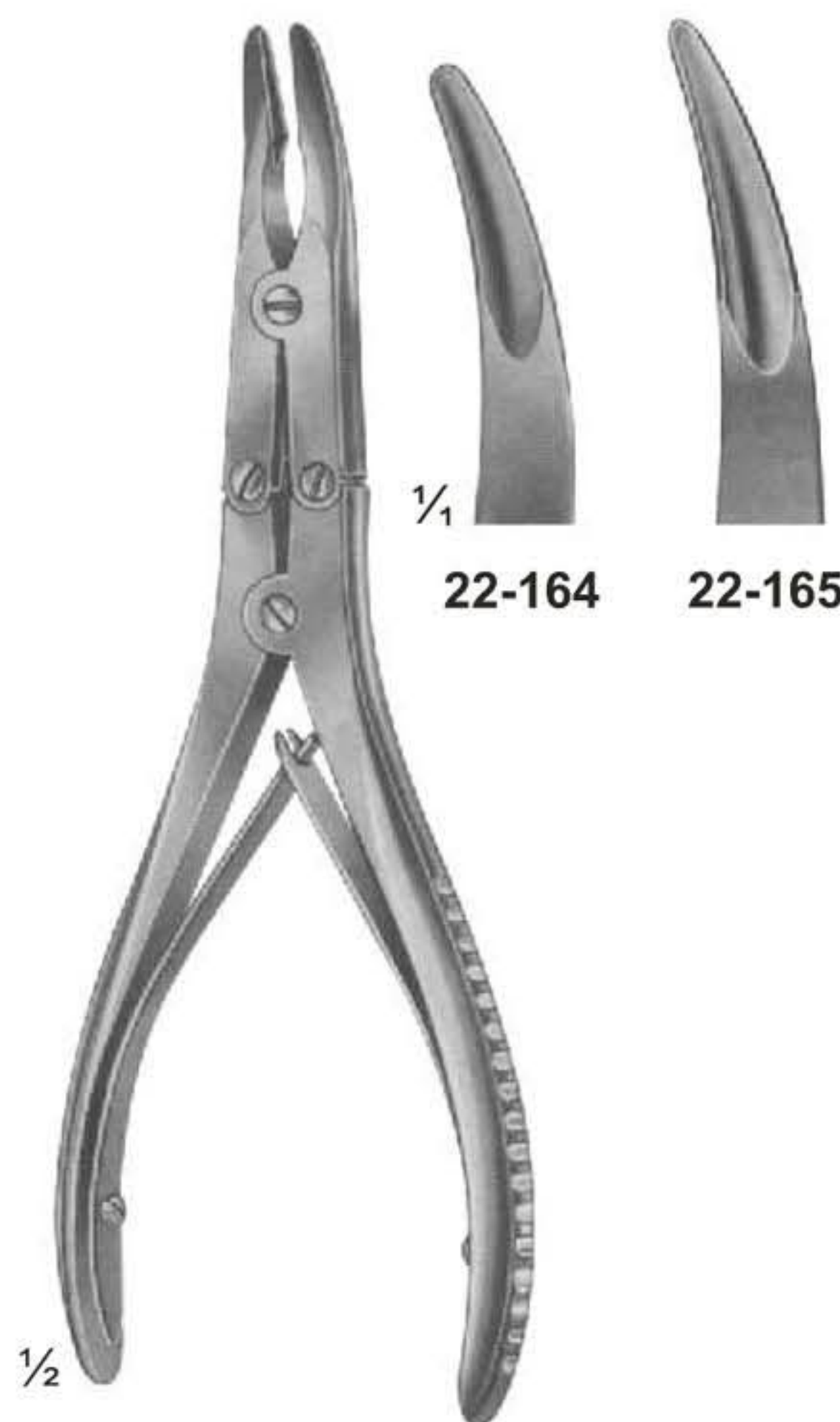

**22-164 - 165**  
BOHLER  
155 mm



**22-166**  
MARQUARTD  
200 mm



# Bone Rongeurs

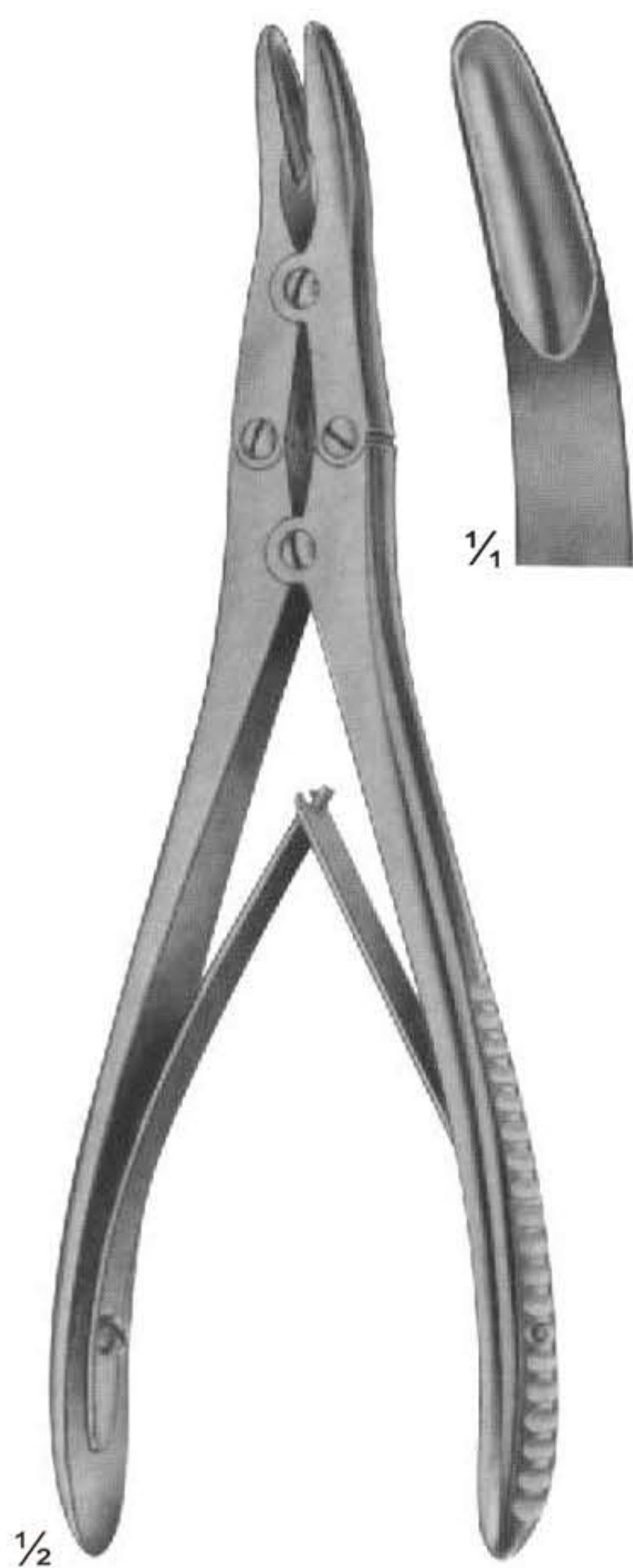

**22-167**  
RUSKIN  
190 mm



**22-168**  
ROTTGEN-RUSKIN  
240 mm

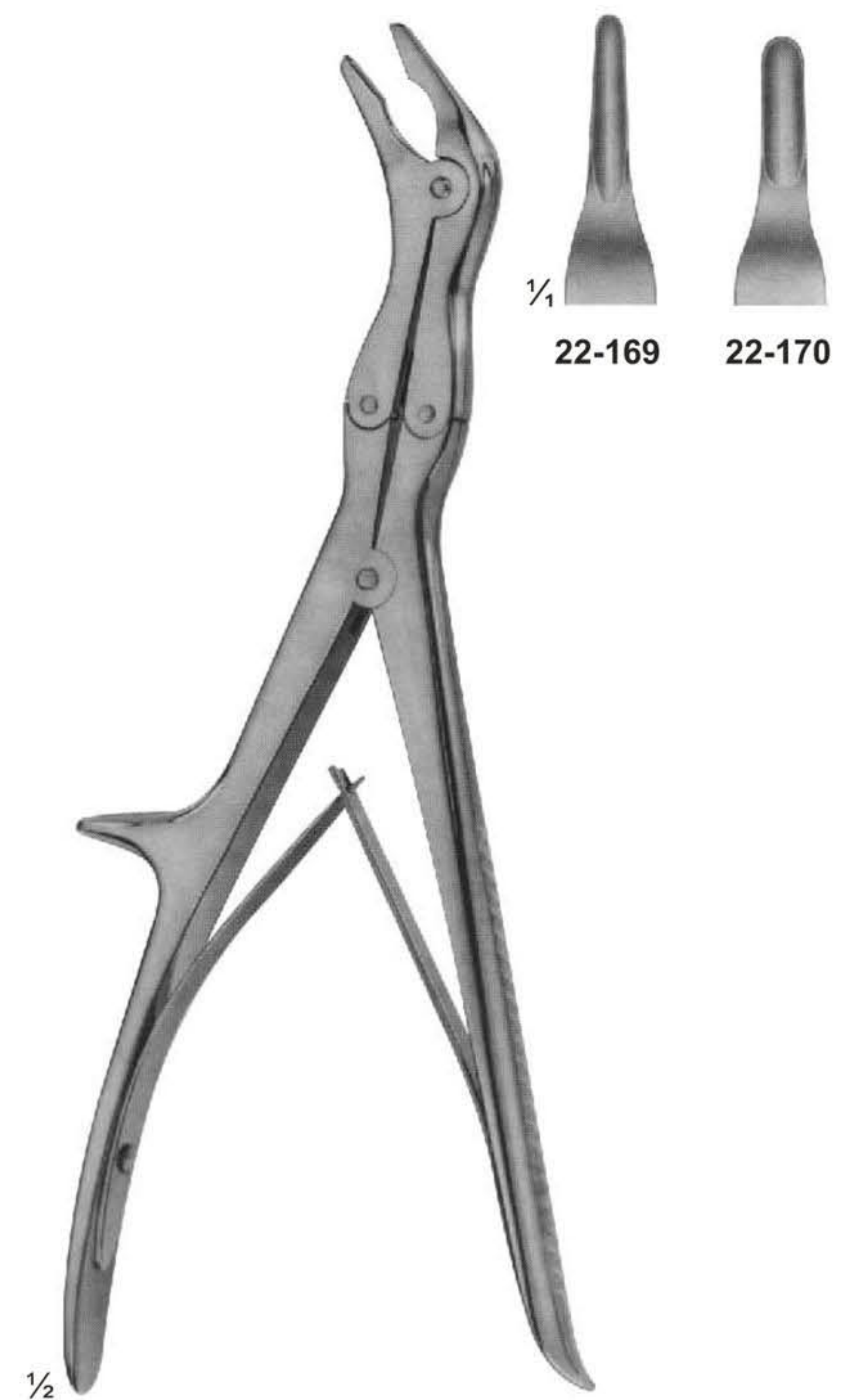

**22-169 - 170**  
ECHLIN  
230 mm



# Bone Rongeurs



**22-171**  
STILLE  
235 mm



**22-172**  
LEKSELL-STILLE  
240mm



**22-173**  
STILLE-RUSKIN  
240mm



# Bone Rongeurs

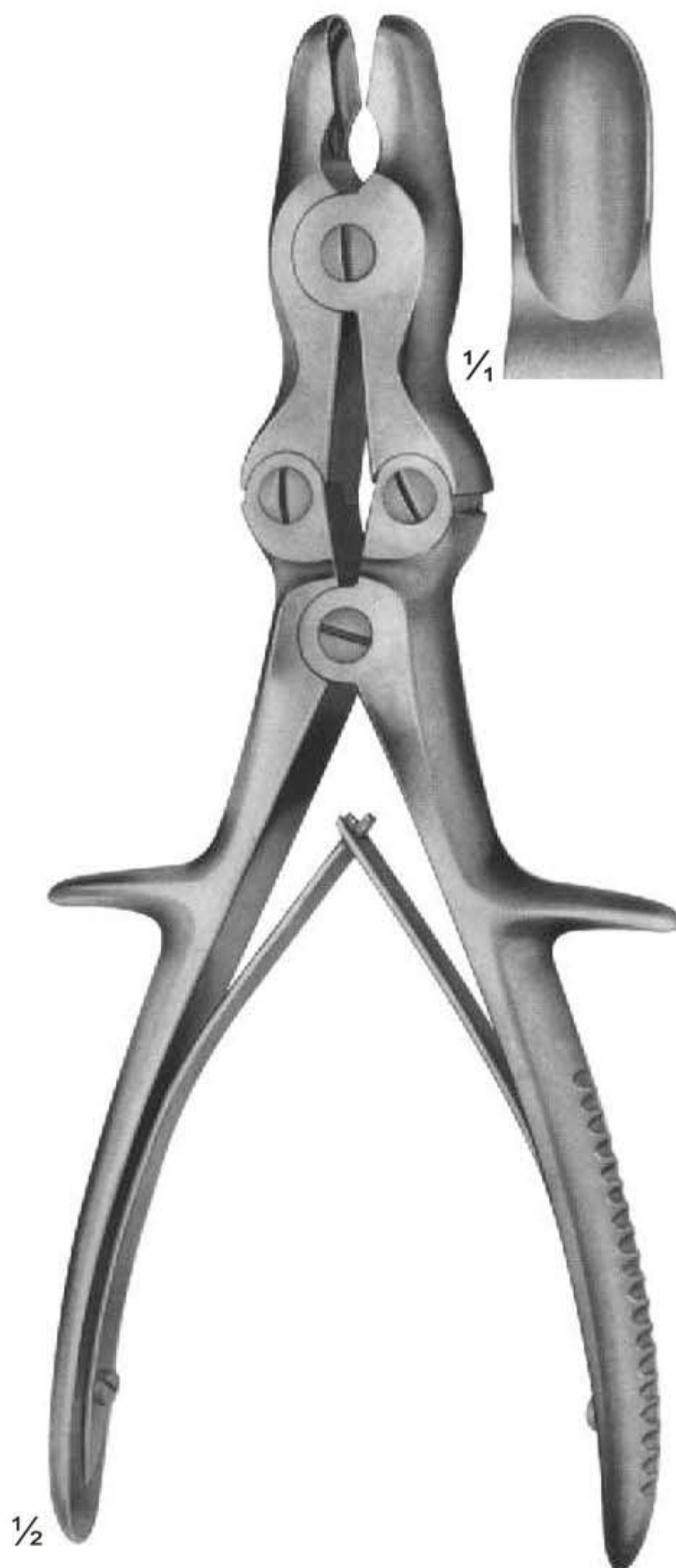

**22-174**  
LURE-STILLE  
225 mm



**22-175**  
LURE-STILLE  
225 mm



**Vena-Cava Clamps**

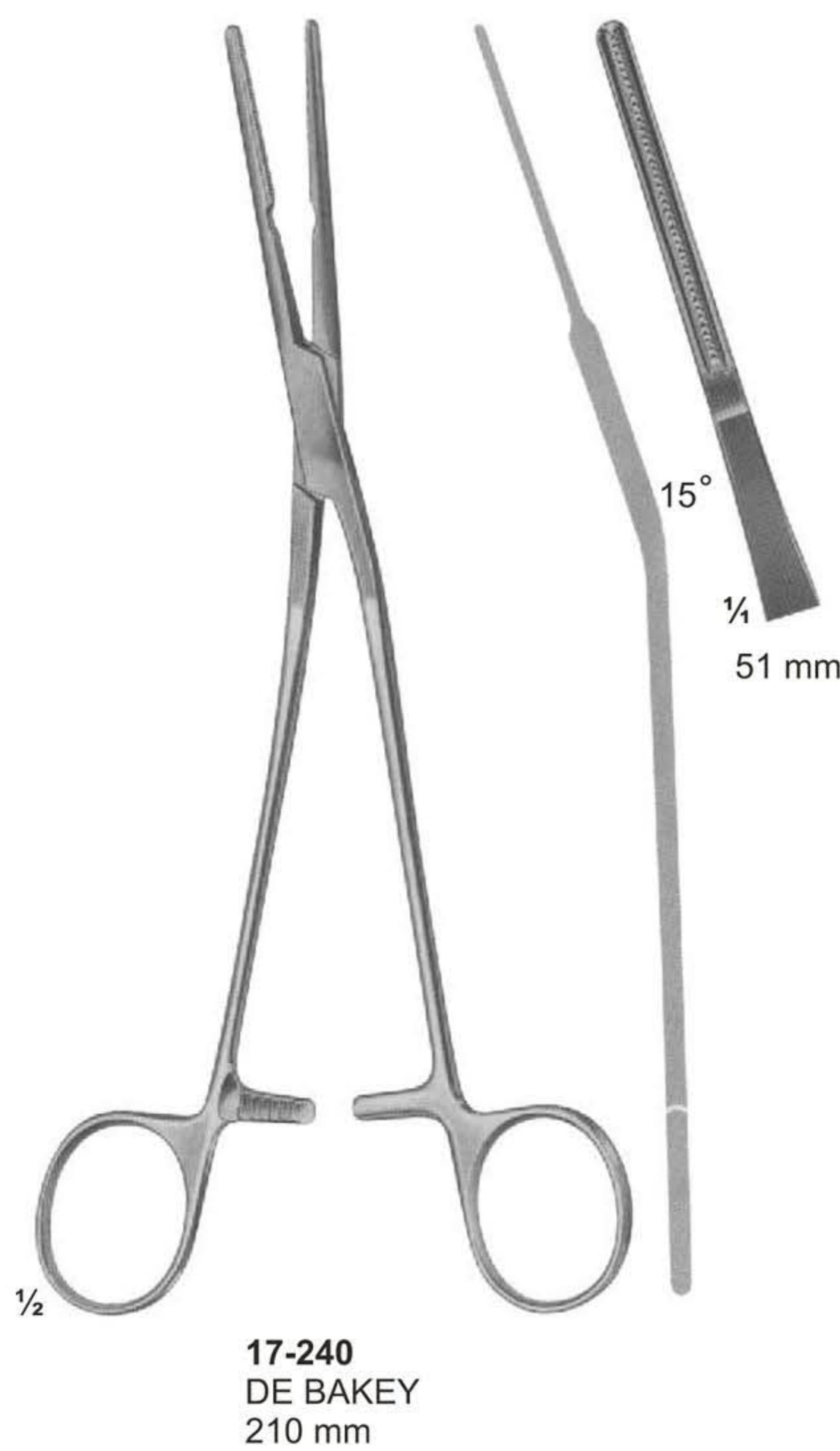
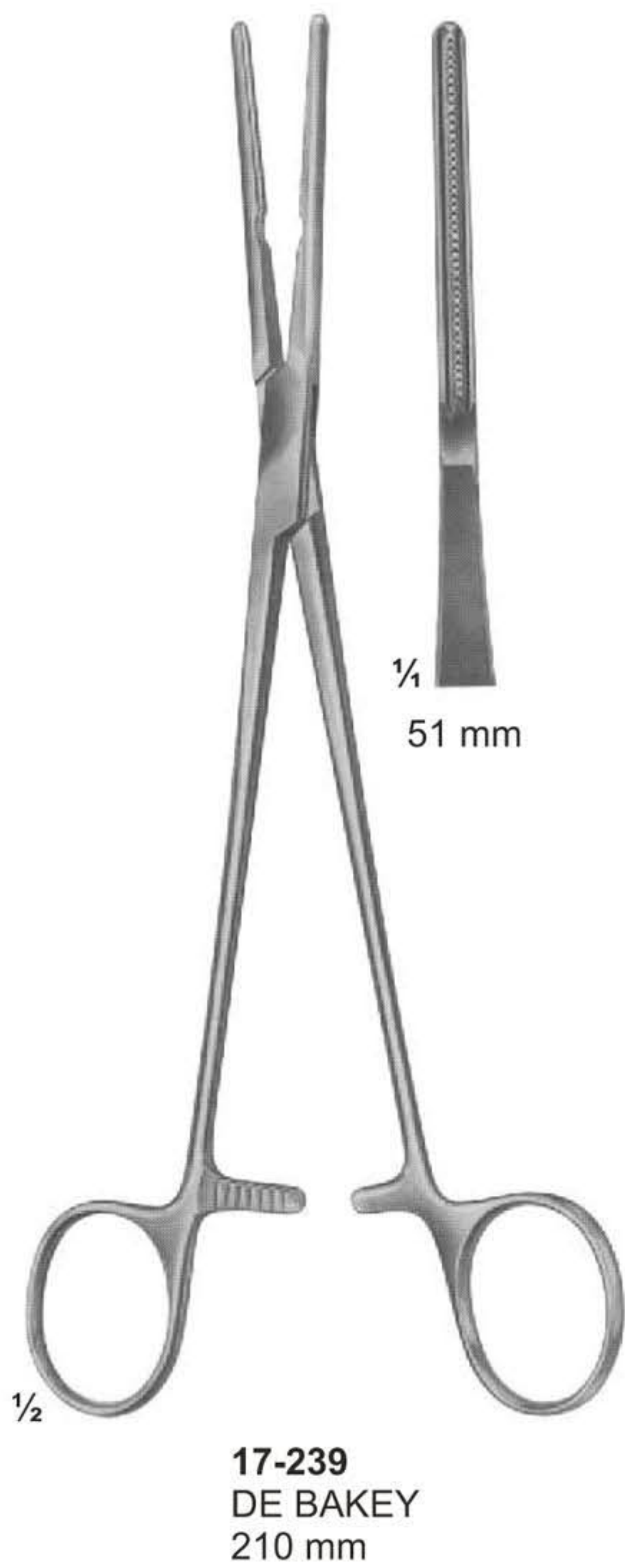
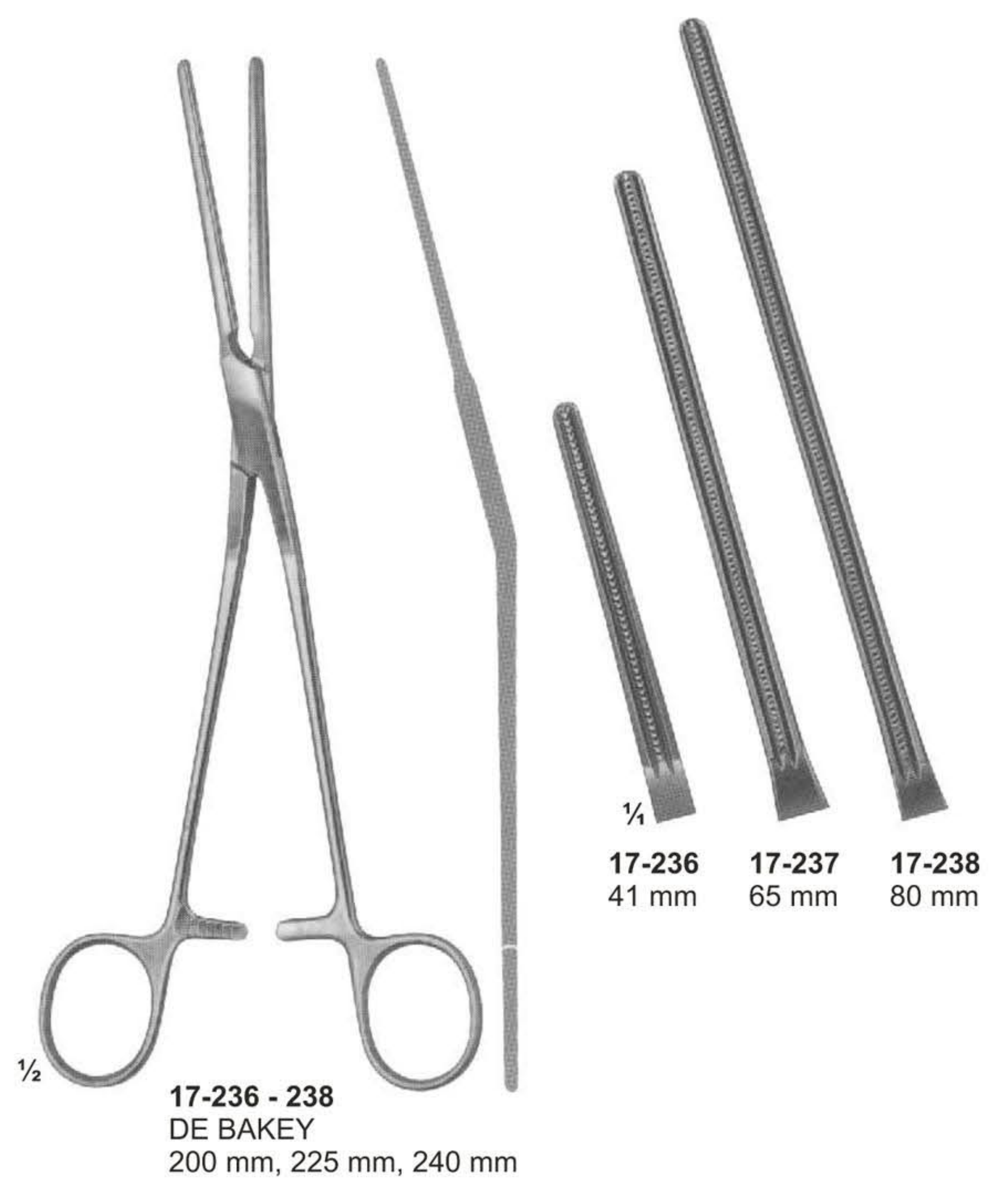



**Bone Cutting Forceps**



**22-178**  
STAMM  
150 mm



**22-179**  
KAZANJIAN  
185 mm

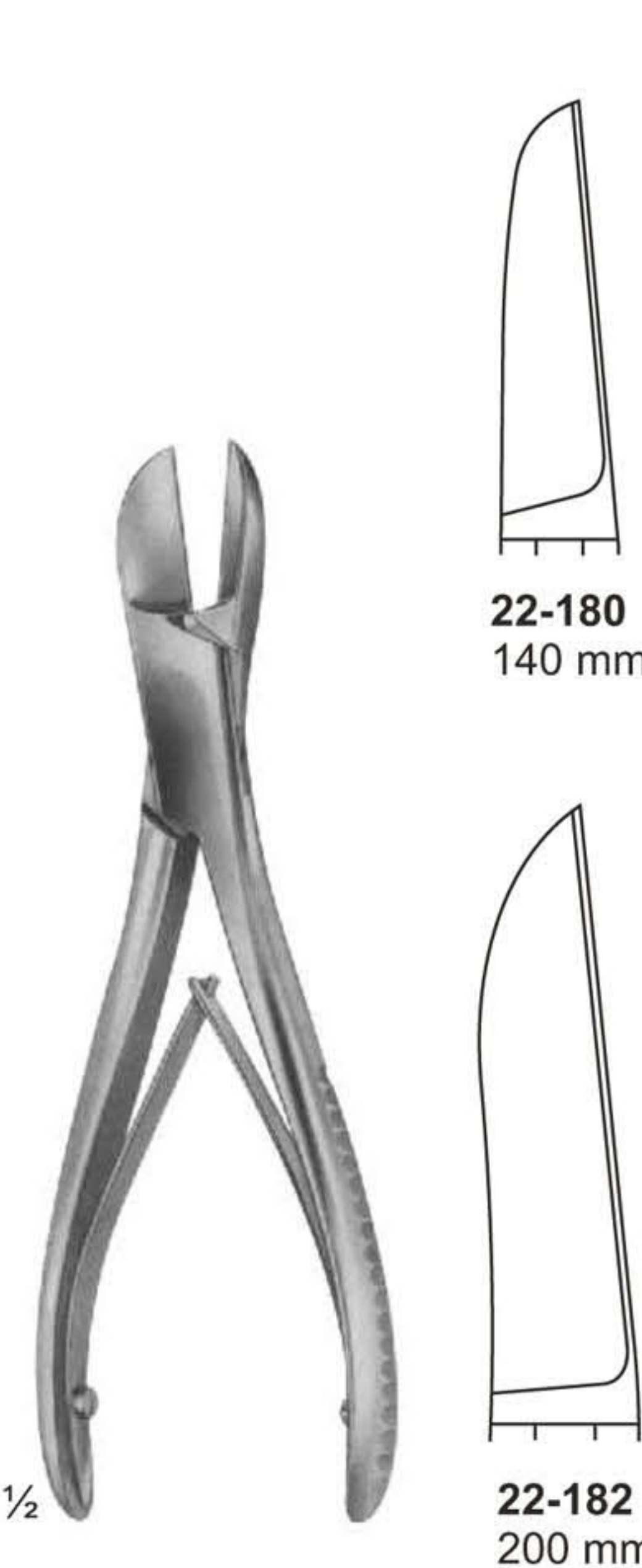

**22-180 - 183**  
LISTON

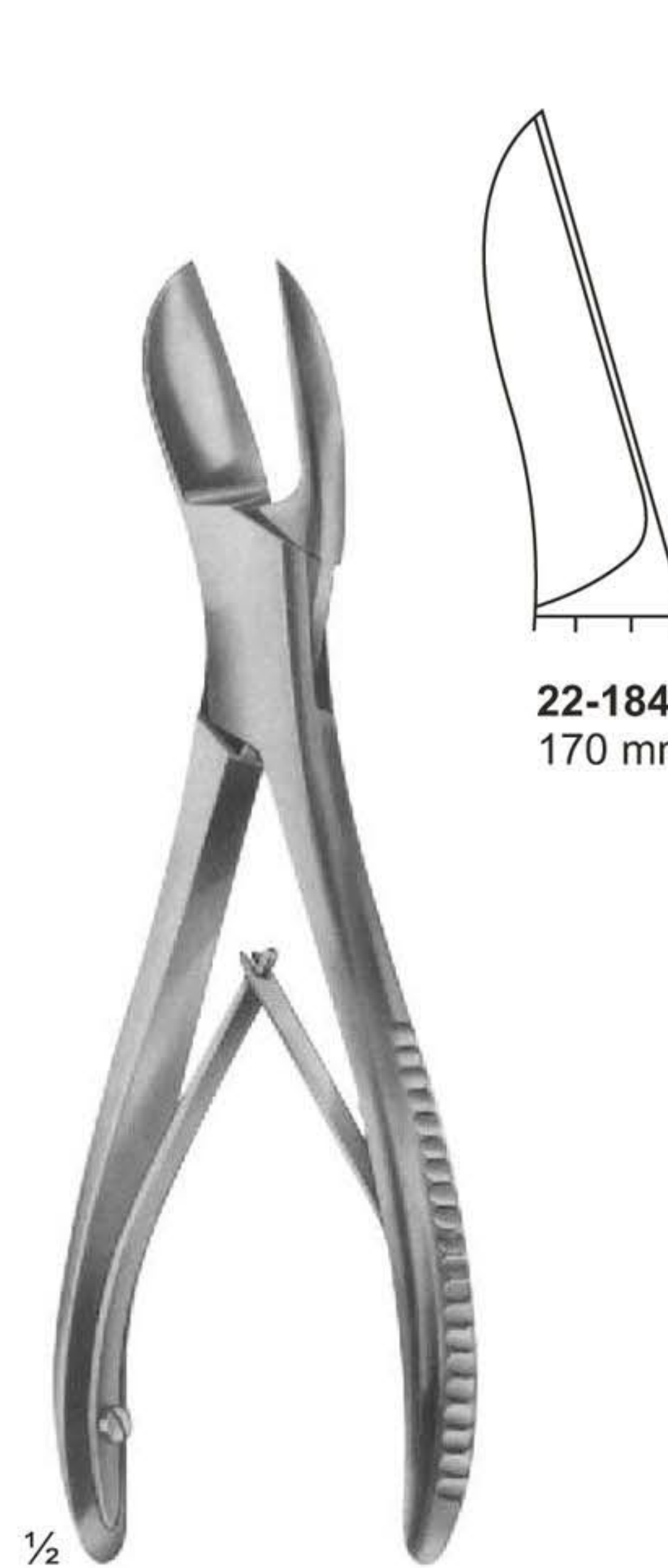
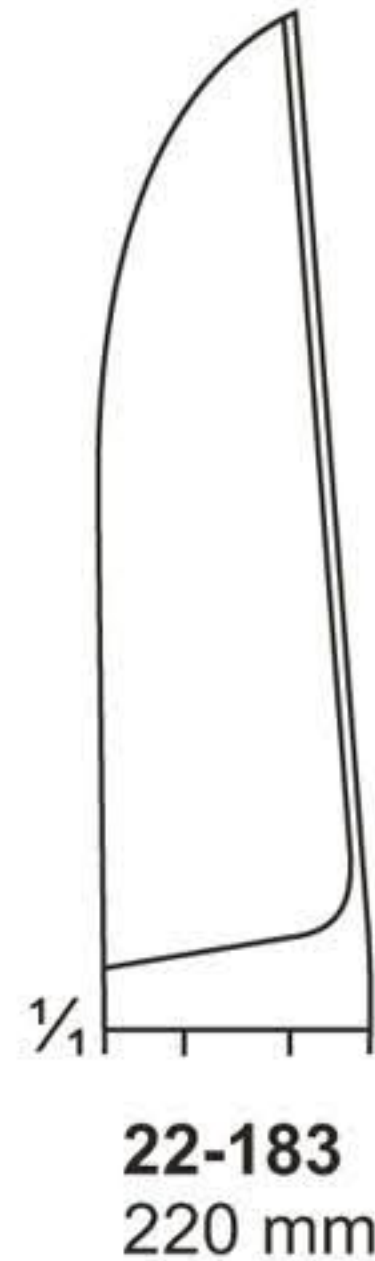
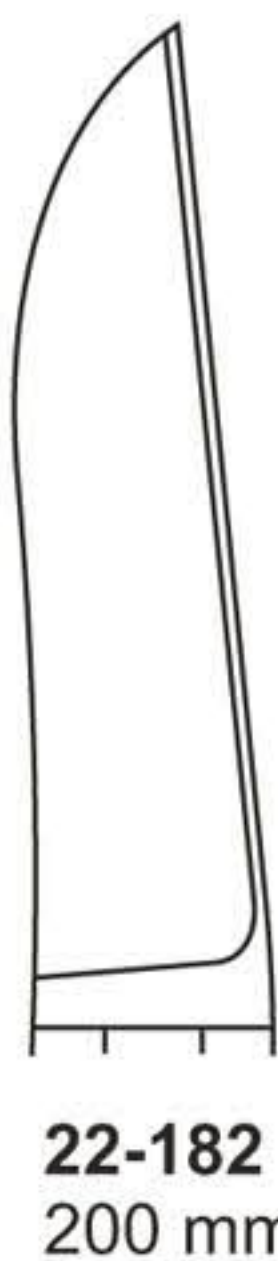
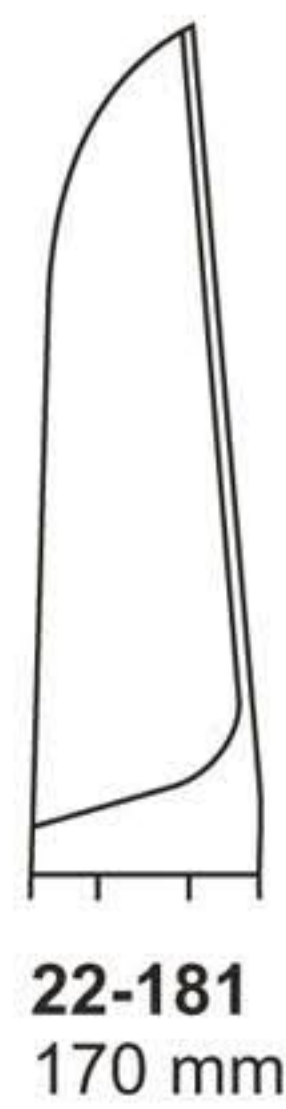
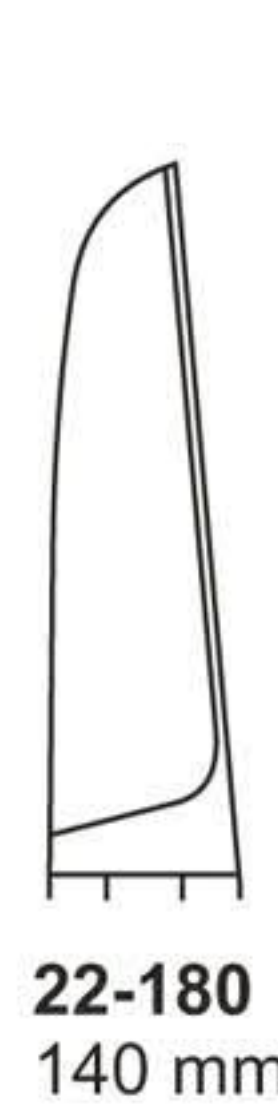

**22-184 - 186**  
LISTON

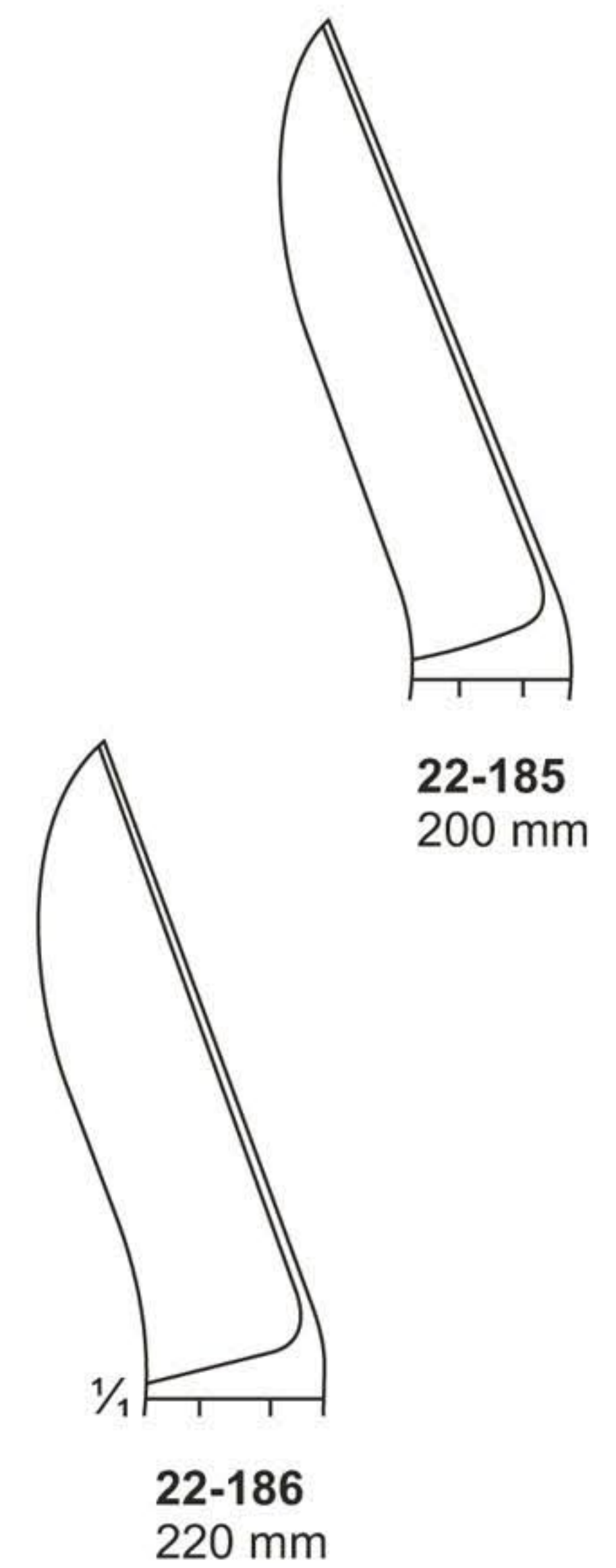
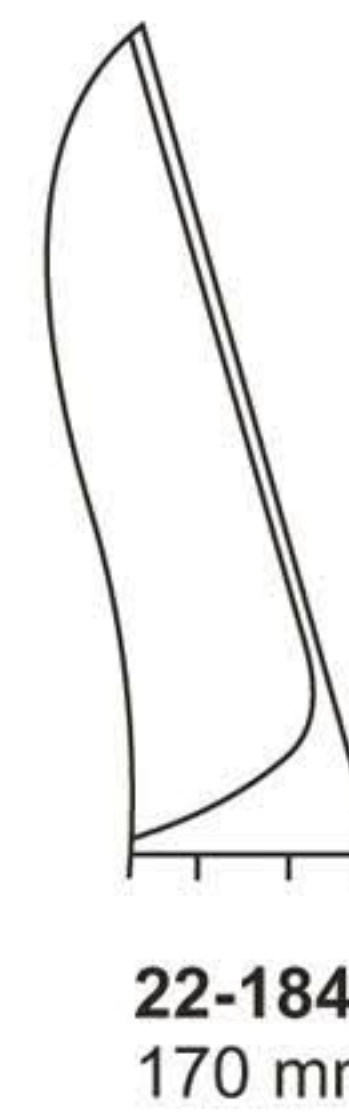



## Bone Cutting Forceps

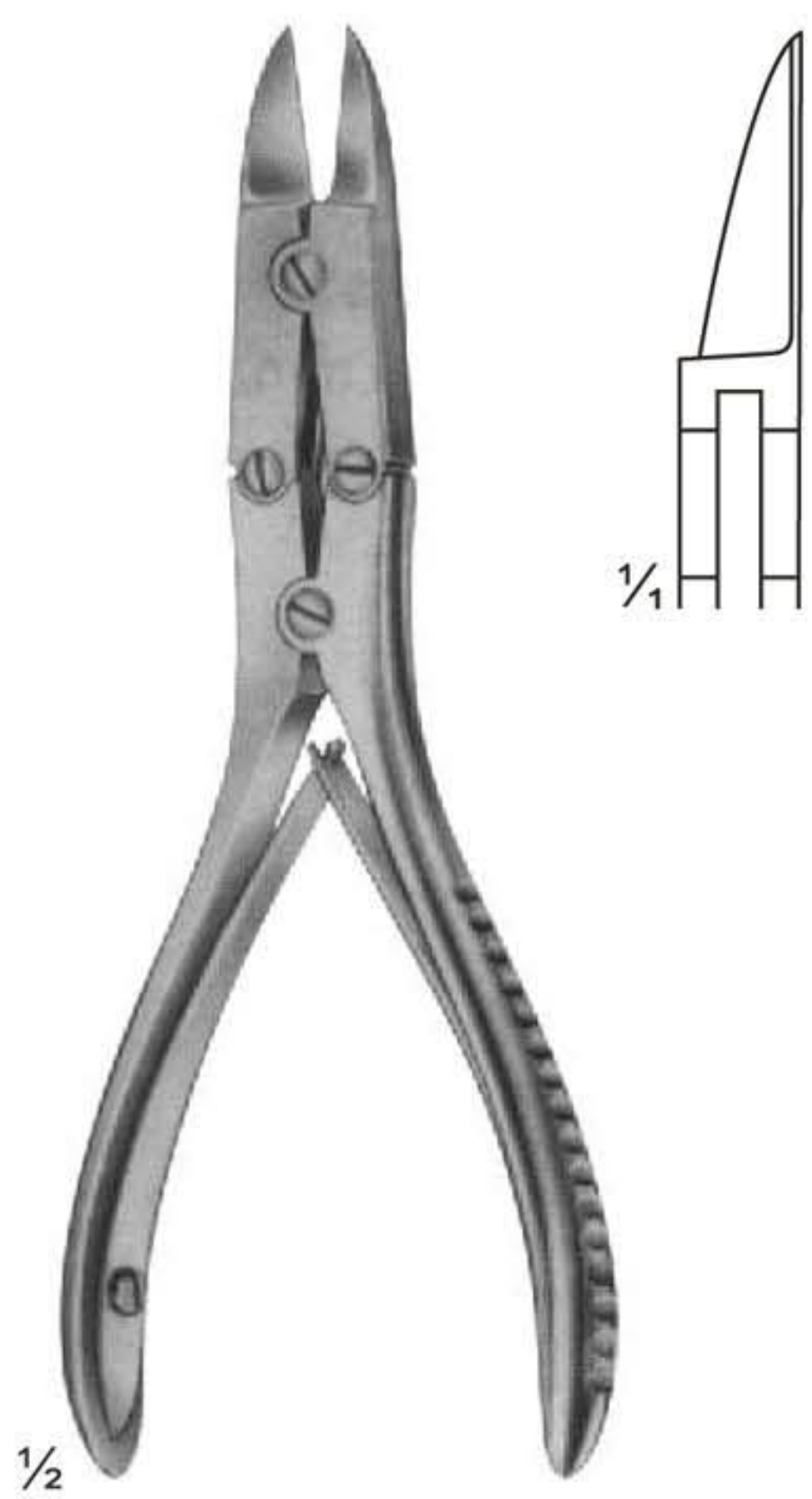

**22-187**  
BOHLER  
145 mm

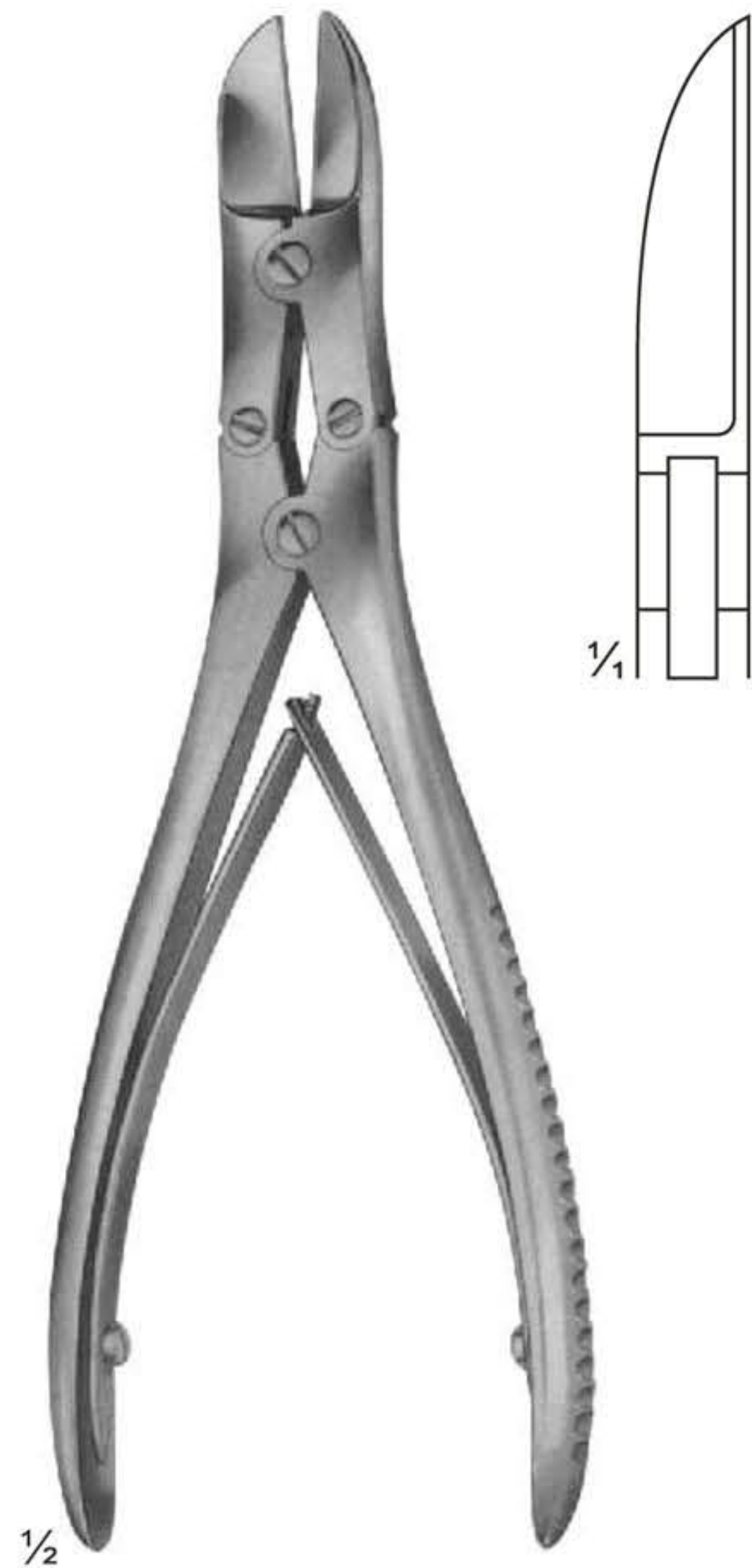

**22-188**  
RUSKIN-LISTON  
190 mm

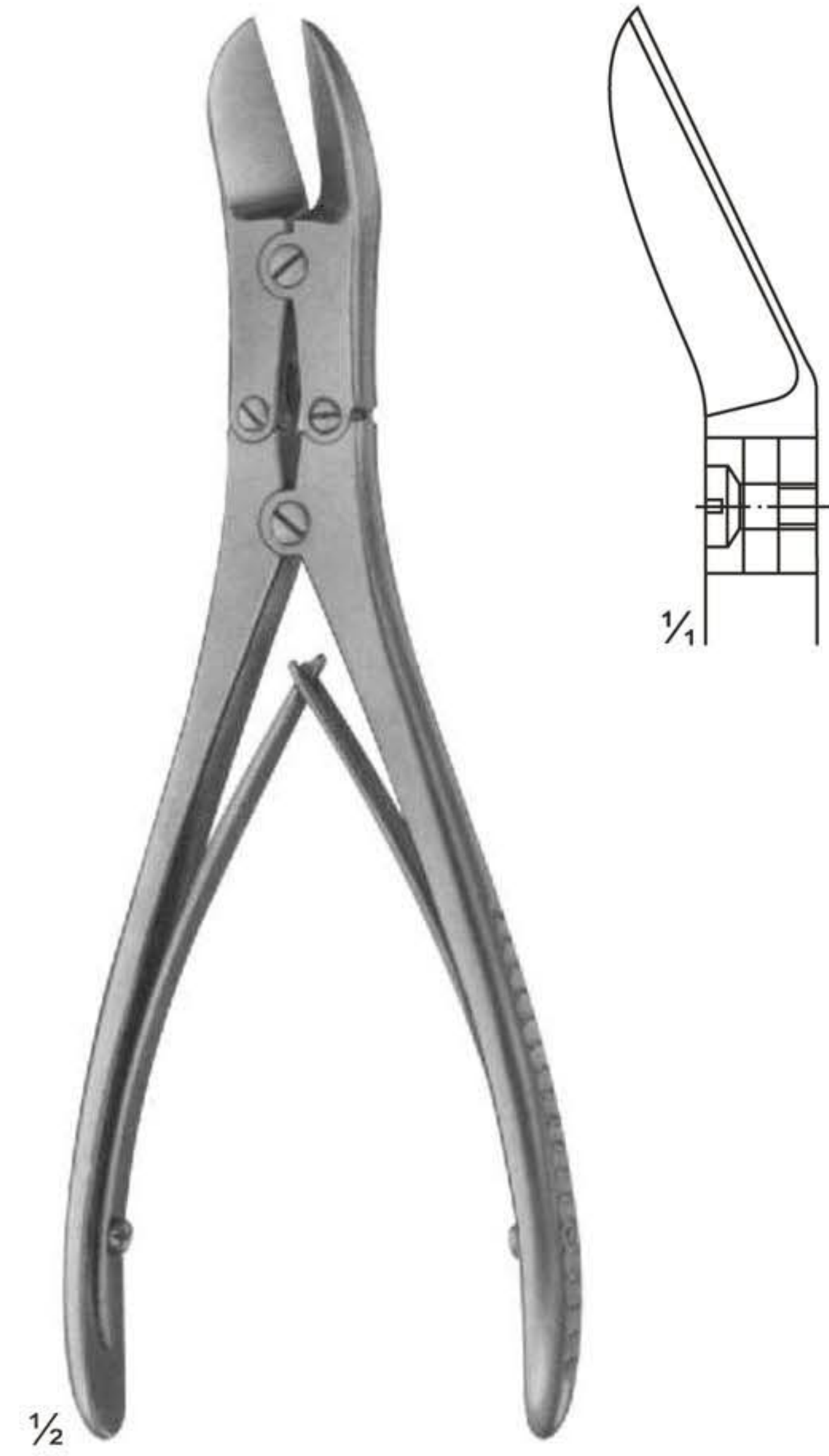

**22-189**  
RUSKIN-LISTON  
190 mm



**Bone Cutting Forceps**

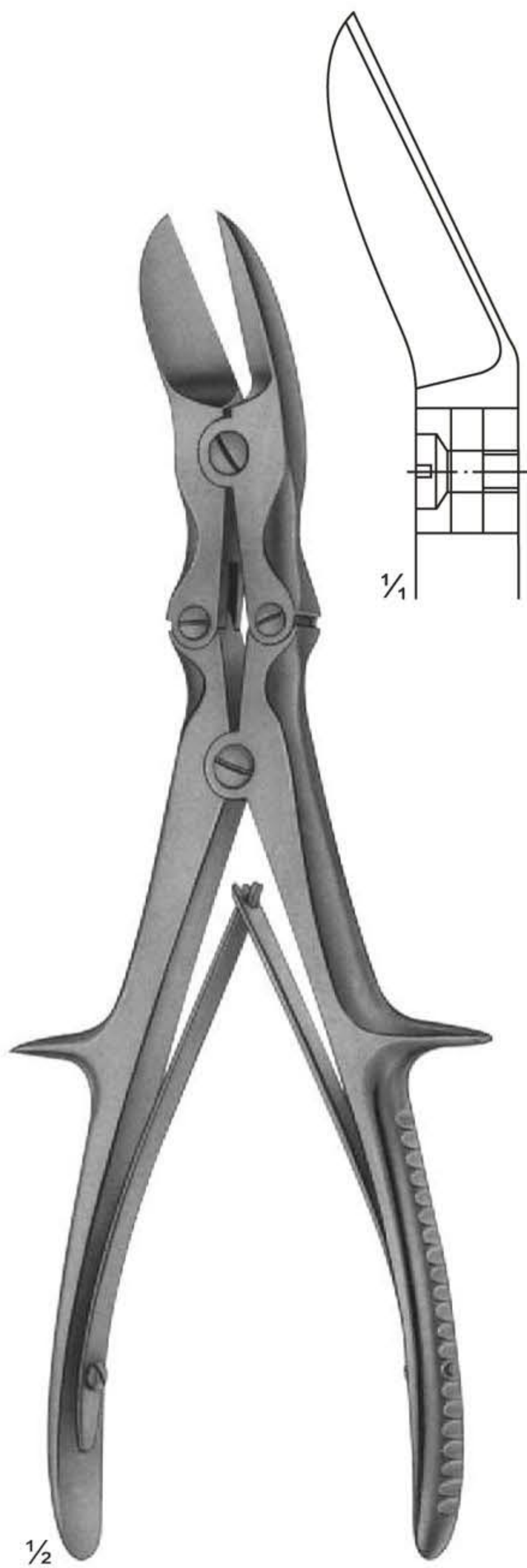

**22-190**  
LISTON  
curved on flat  
240 mm

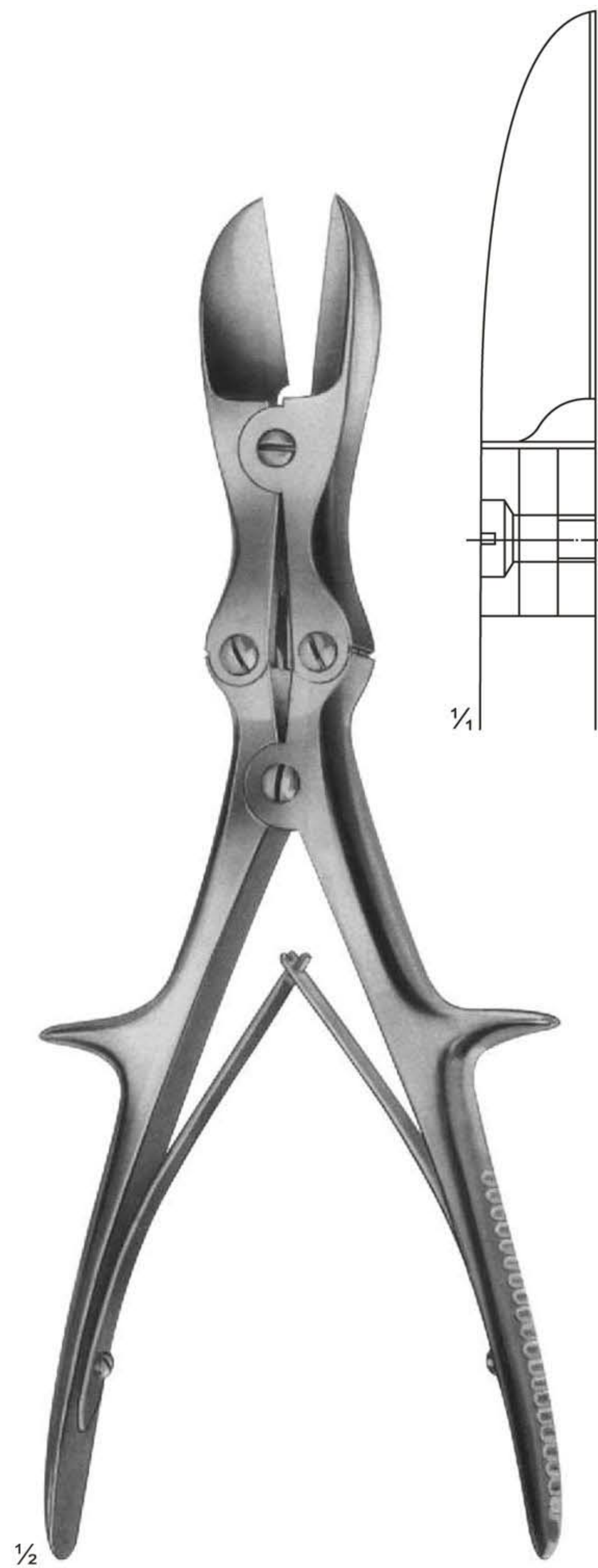

**22-191**  
LISTON  
straight  
280 mm

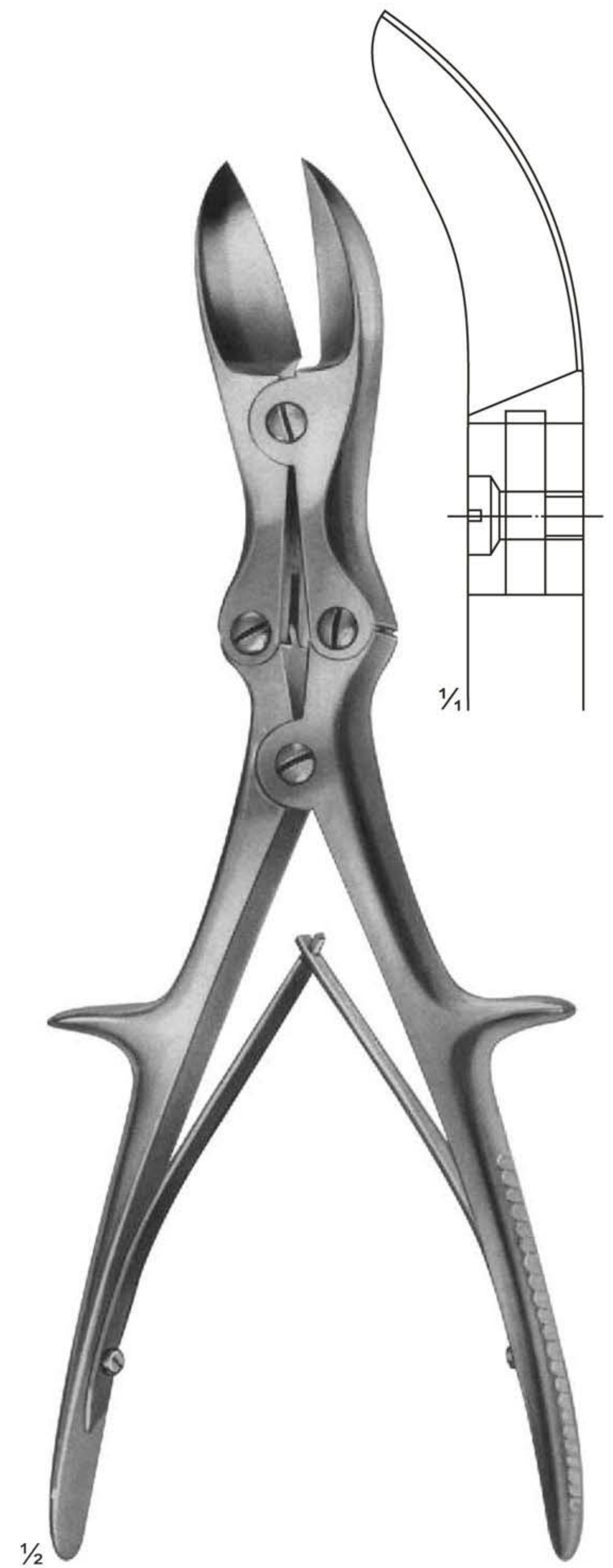

**22-192**  
LISTON  
curved on flat  
280 mm



# Bone Cutting Forceps

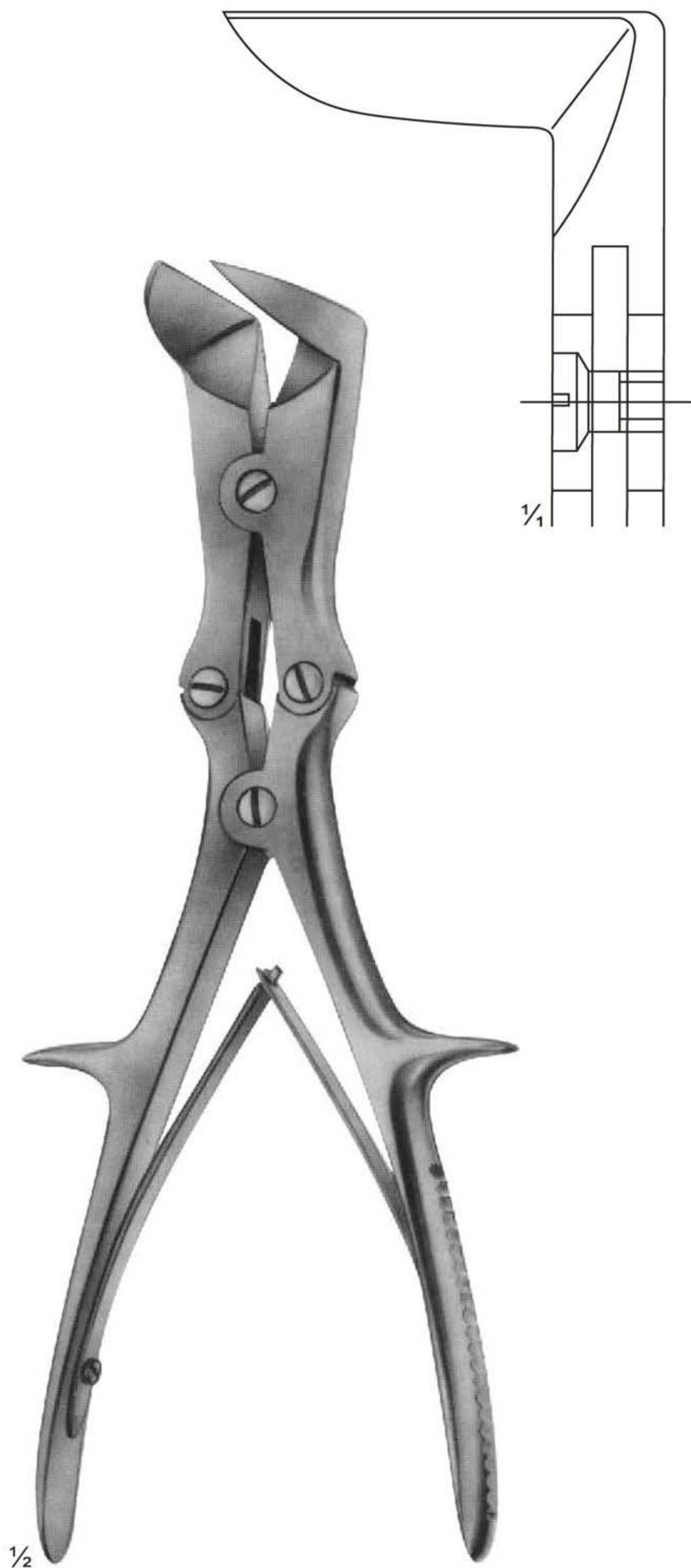

**22-193**  
LISTON-STILLE  
265 mm

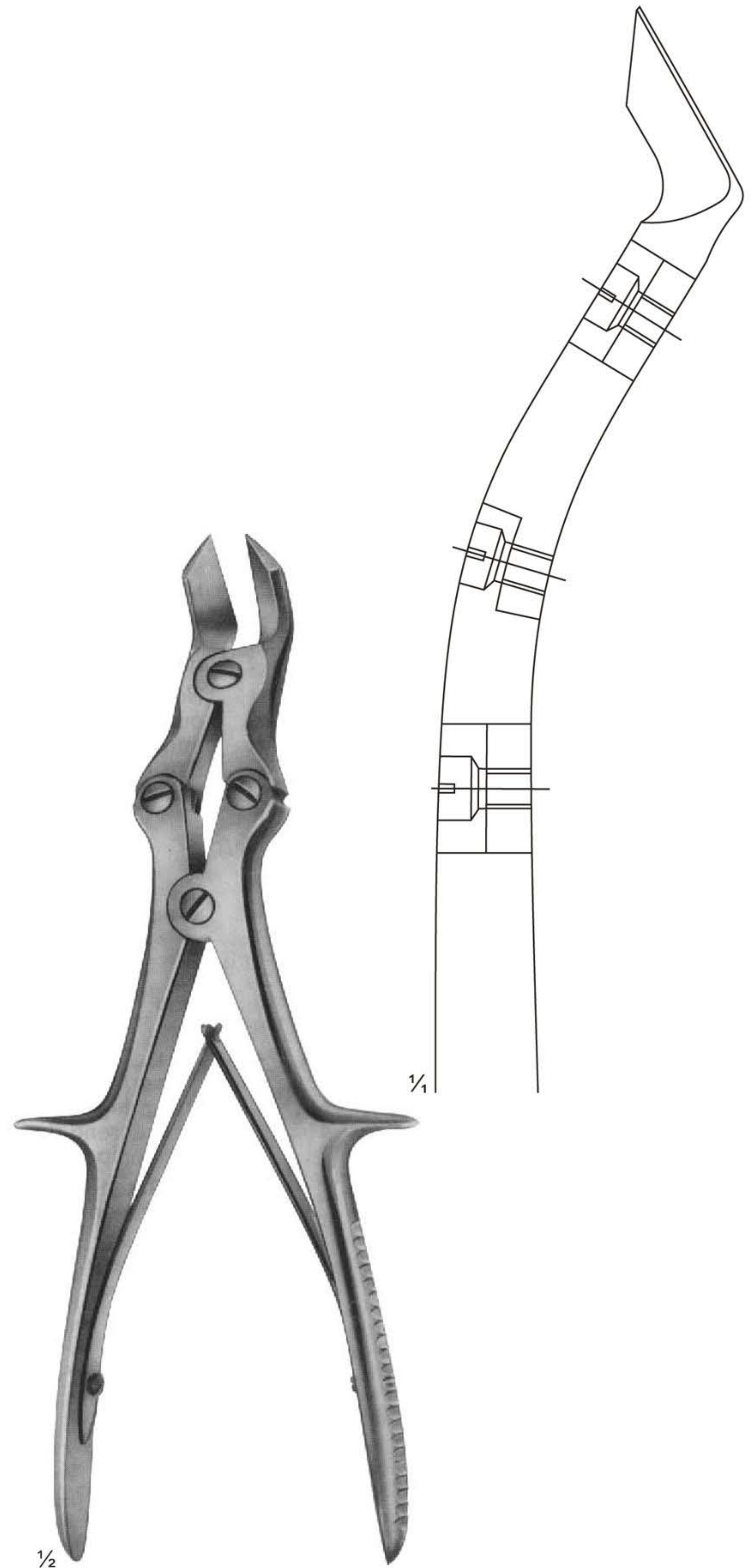

**22-194**  
LISTON-KEY-HORSLEY  
(TUDOR EDWARDS)  
255 mm



**Meniscus-and Cartilage Forceps**

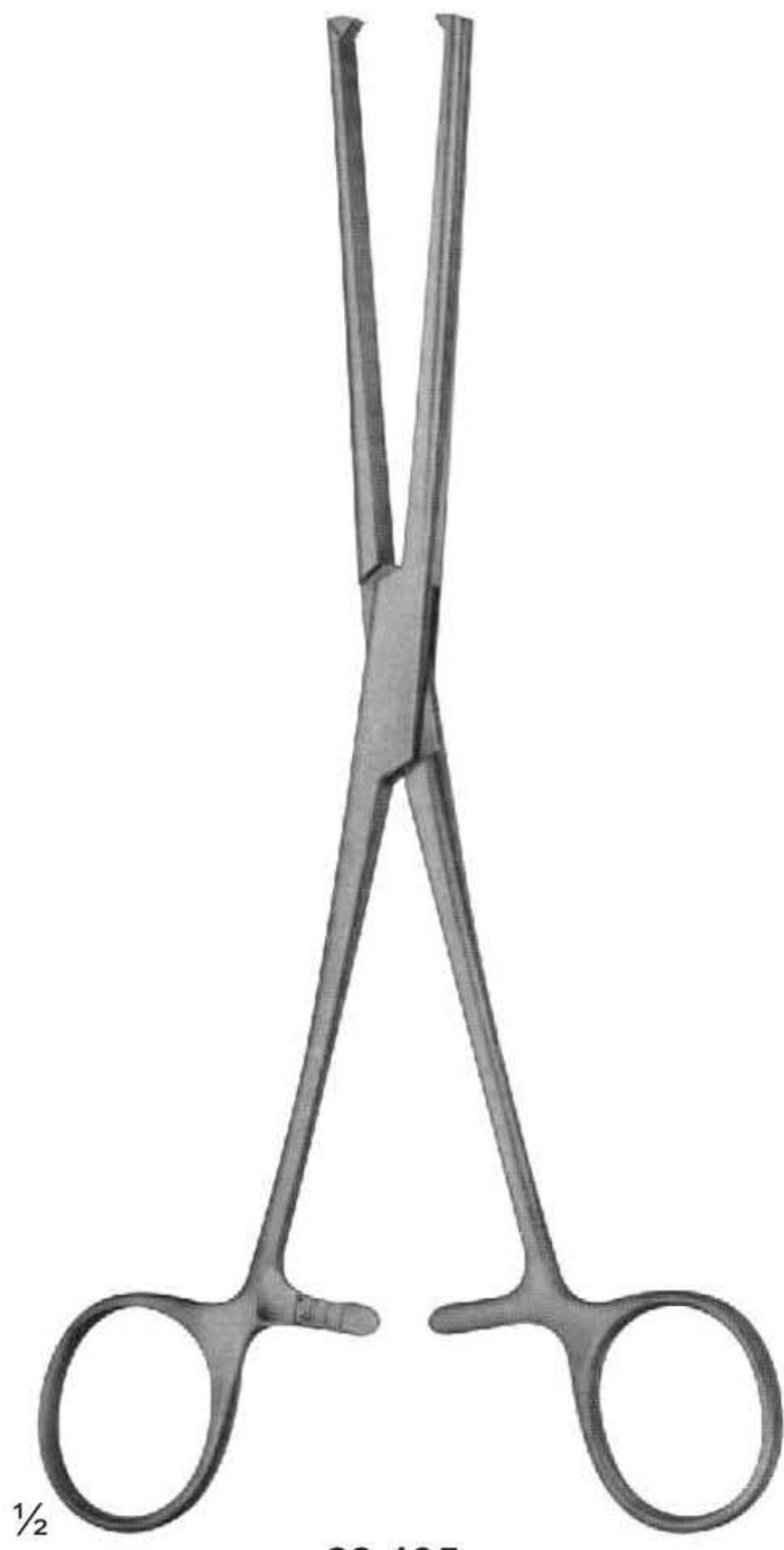

**22-195**  
BIRCHER  
200 mm

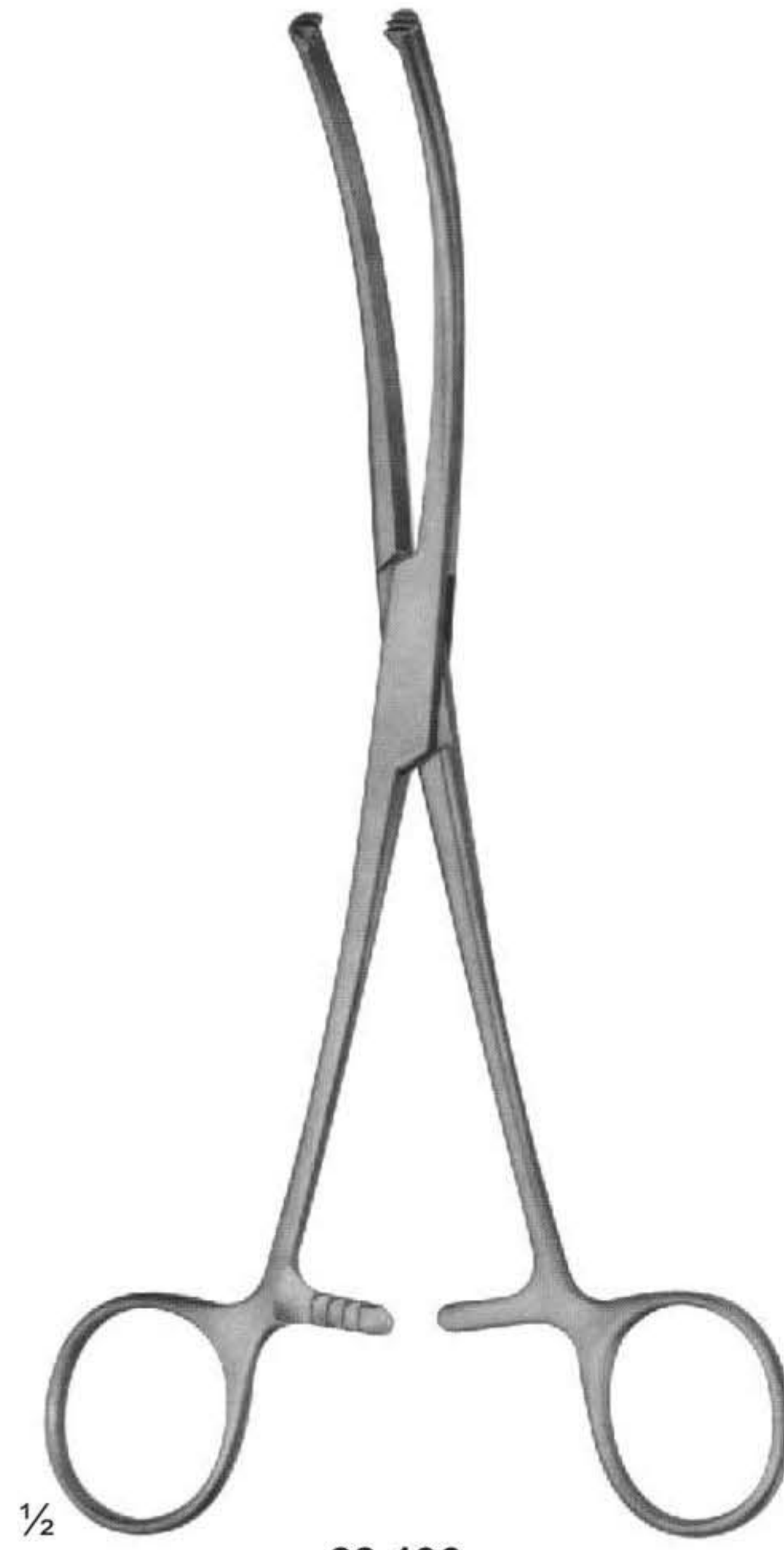

**22-196**  
BIRCHER  
200 mm

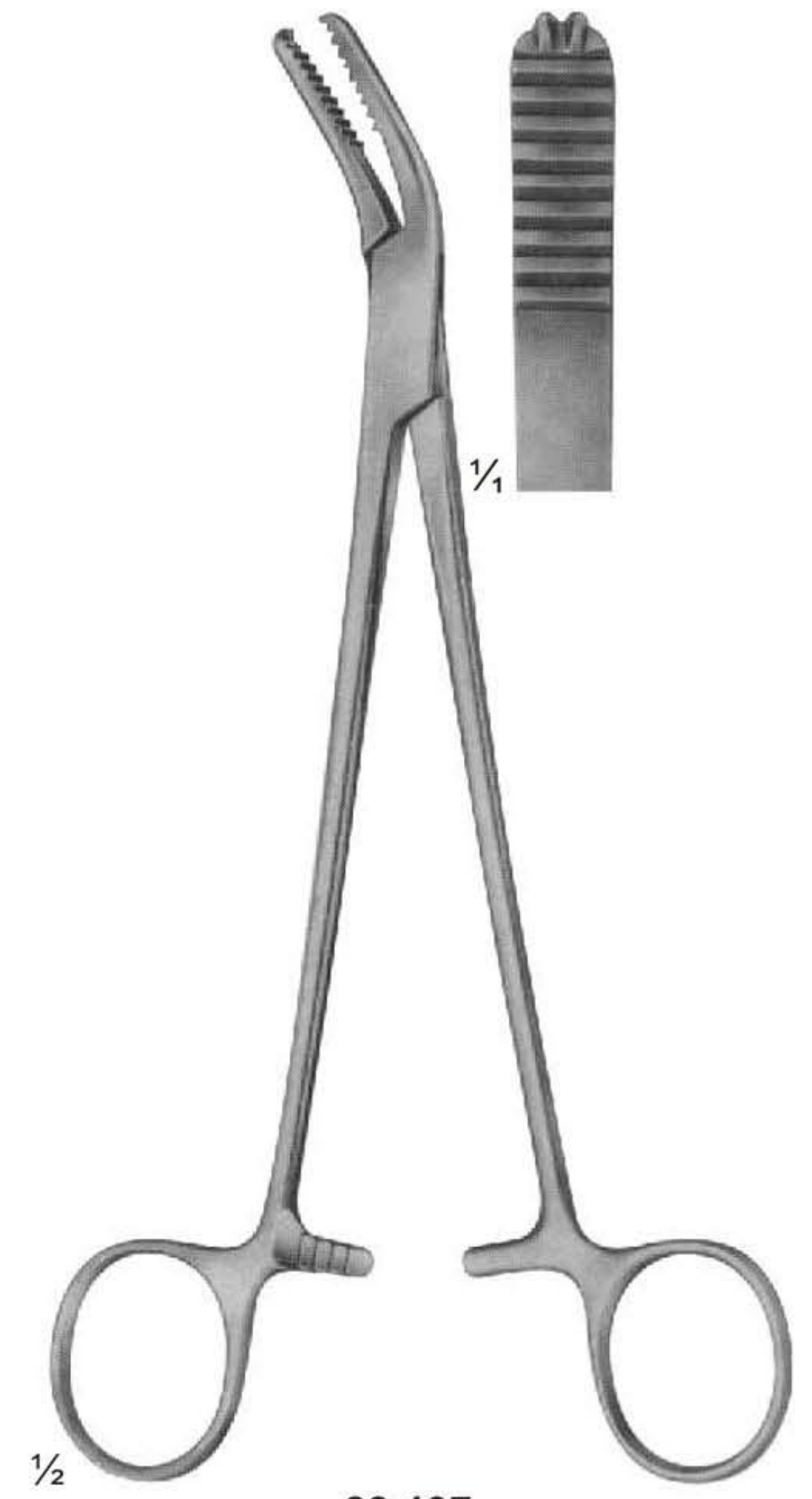

**22-197**  
WELLER  
200 mm

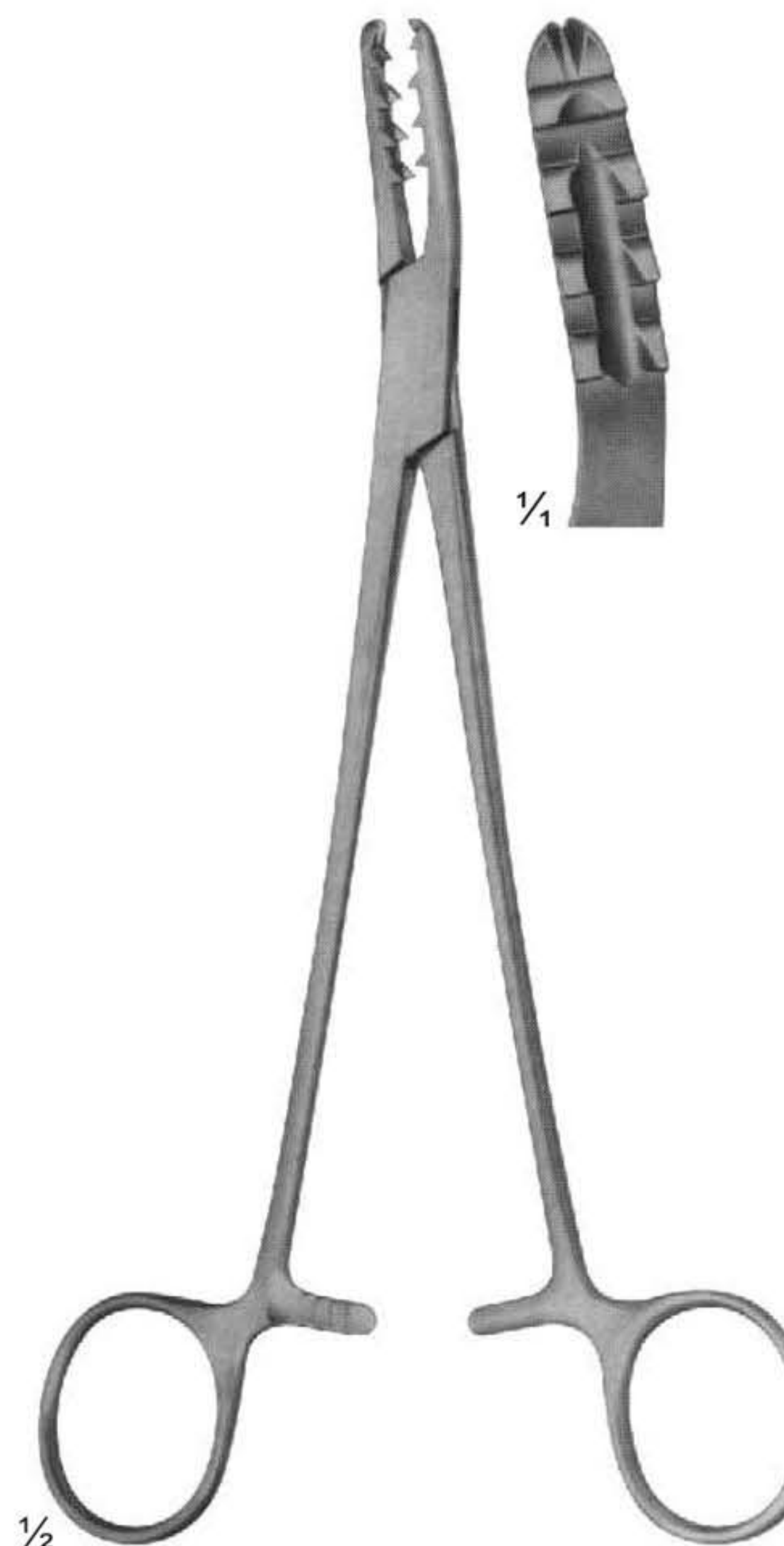

**22-198**  
BIRCHER-GANSKE  
200 mm

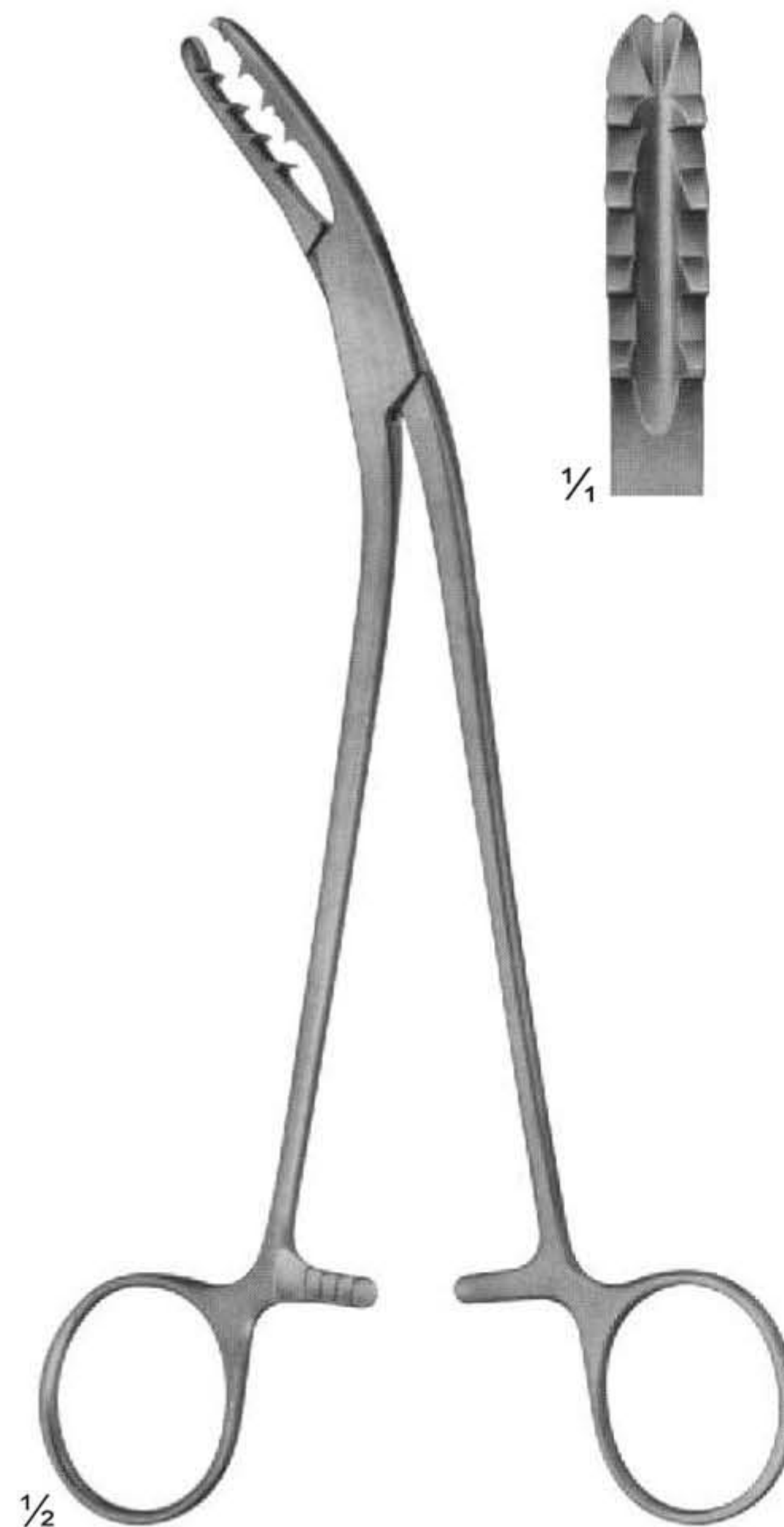

**22-199**  
BIRCHER-GANSKE  
200 mm



**22-200**  
MARTIN  
205 mm



# Meniscus Knives

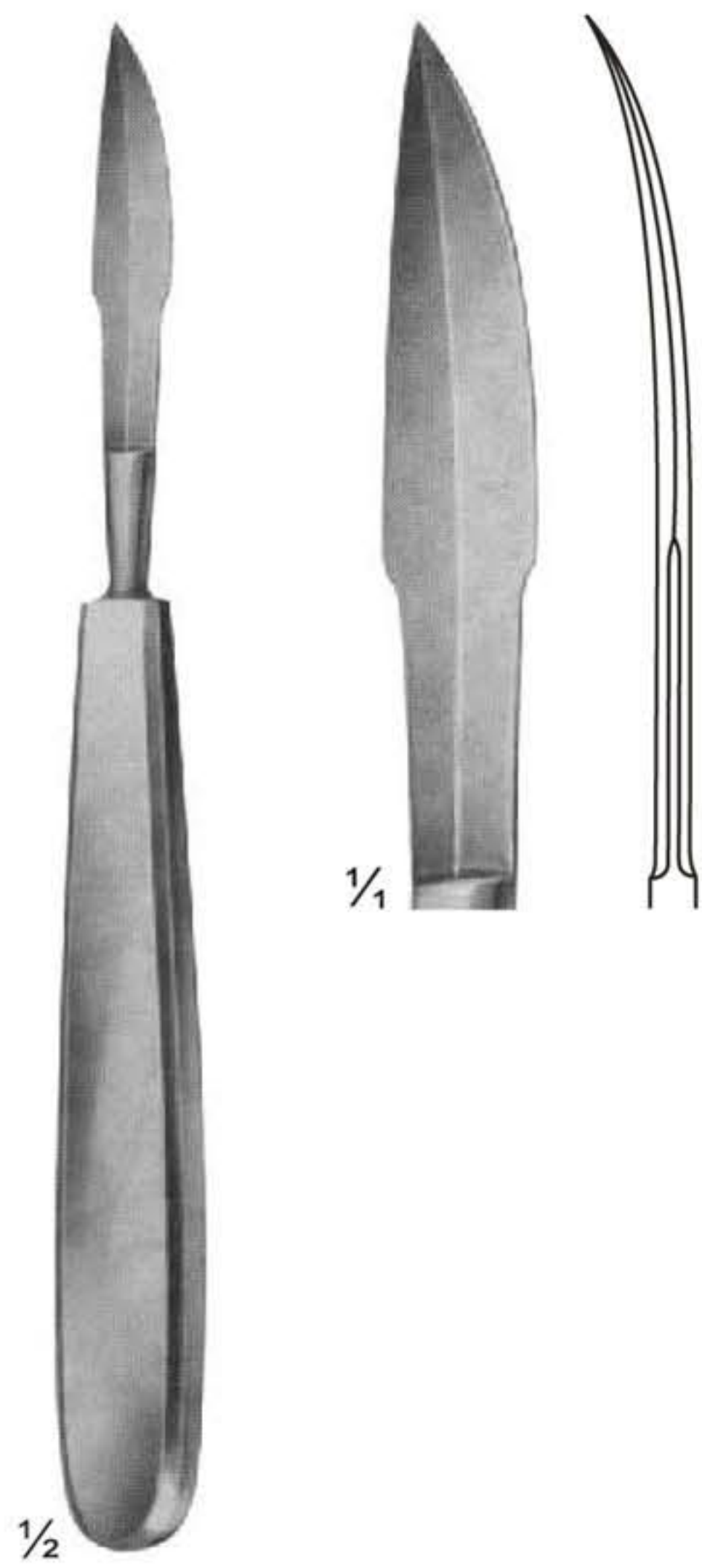

$\frac{1}{2}$   
**22-201**  
170 mm

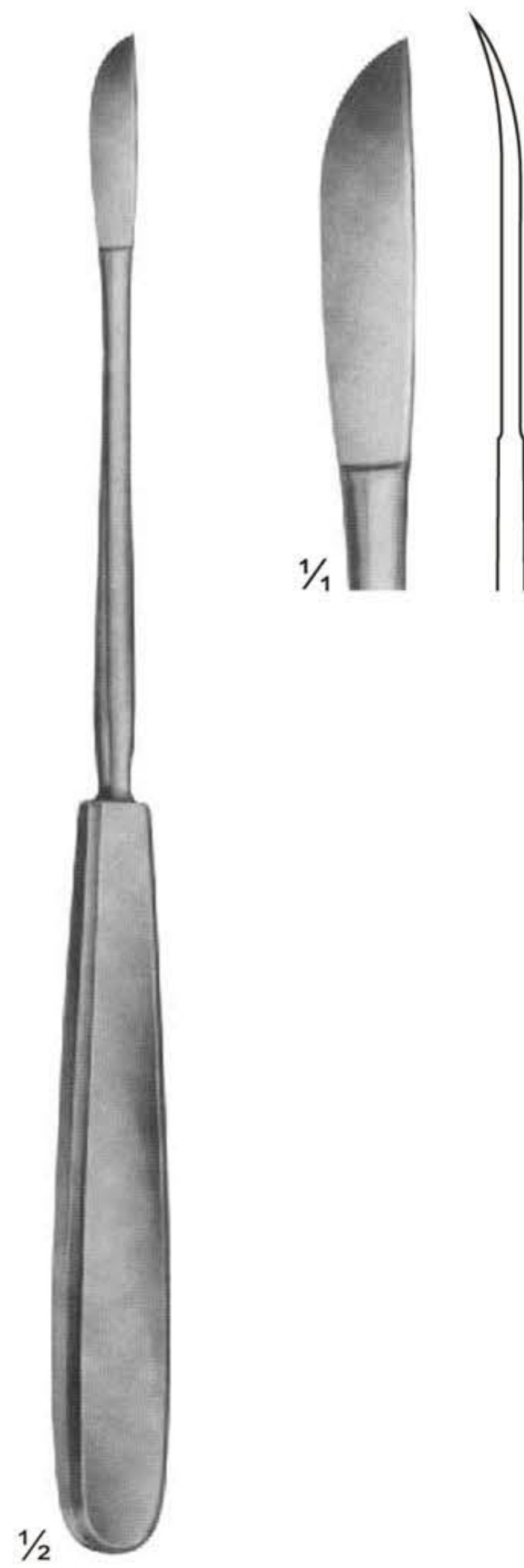

$\frac{1}{2}$   
**22-202**  
NEFF  
215 mm



$\frac{1}{2}$   
**22-203**  
NEFF  
215 mm



$\frac{1}{2}$   
**22-204**  
WAGNER  
215 mm



**Meniscus Knives**

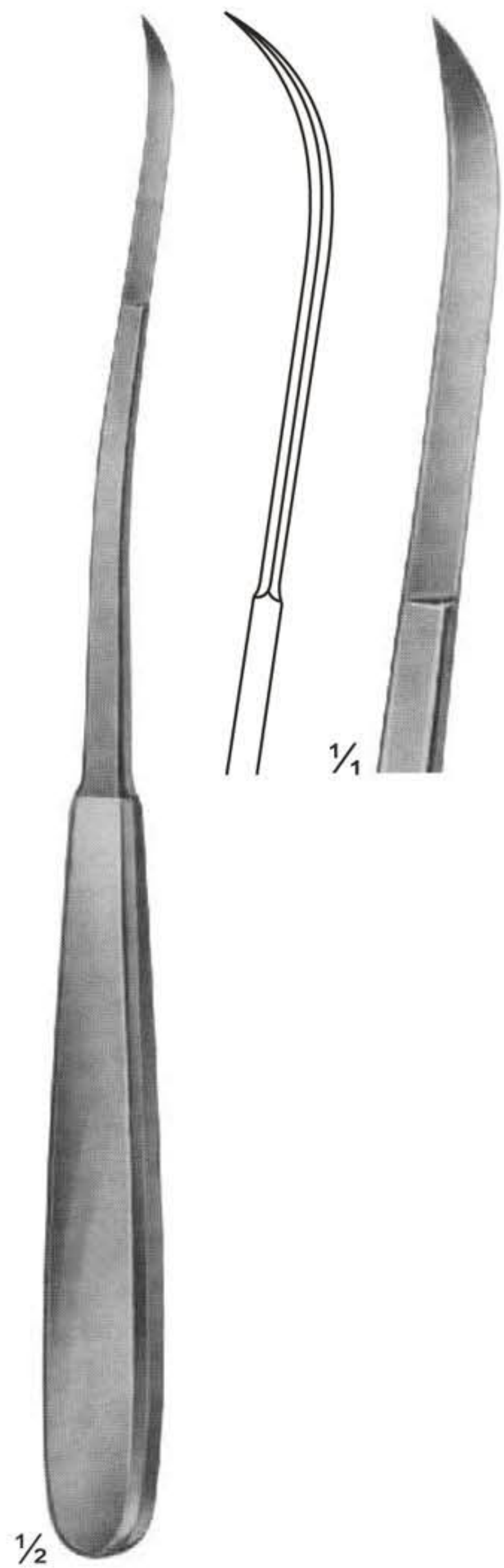

**22-205**  
SALENIUS  
220 mm

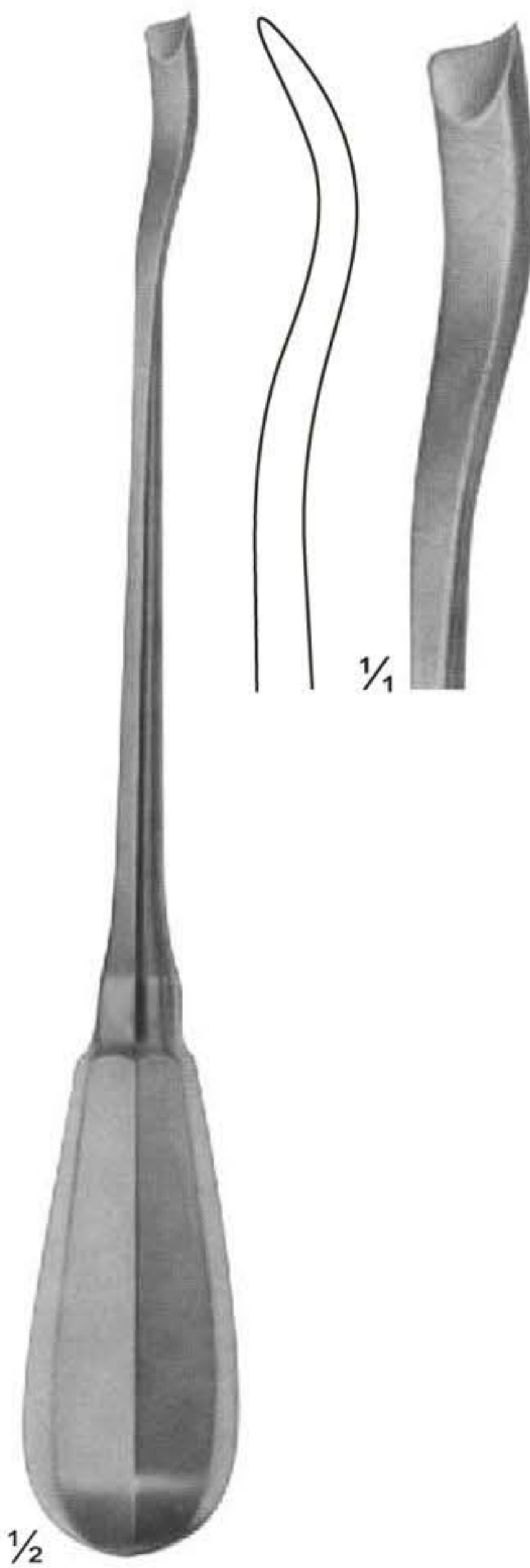

**22-206**  
CHNAD.MODELL  
200 mm

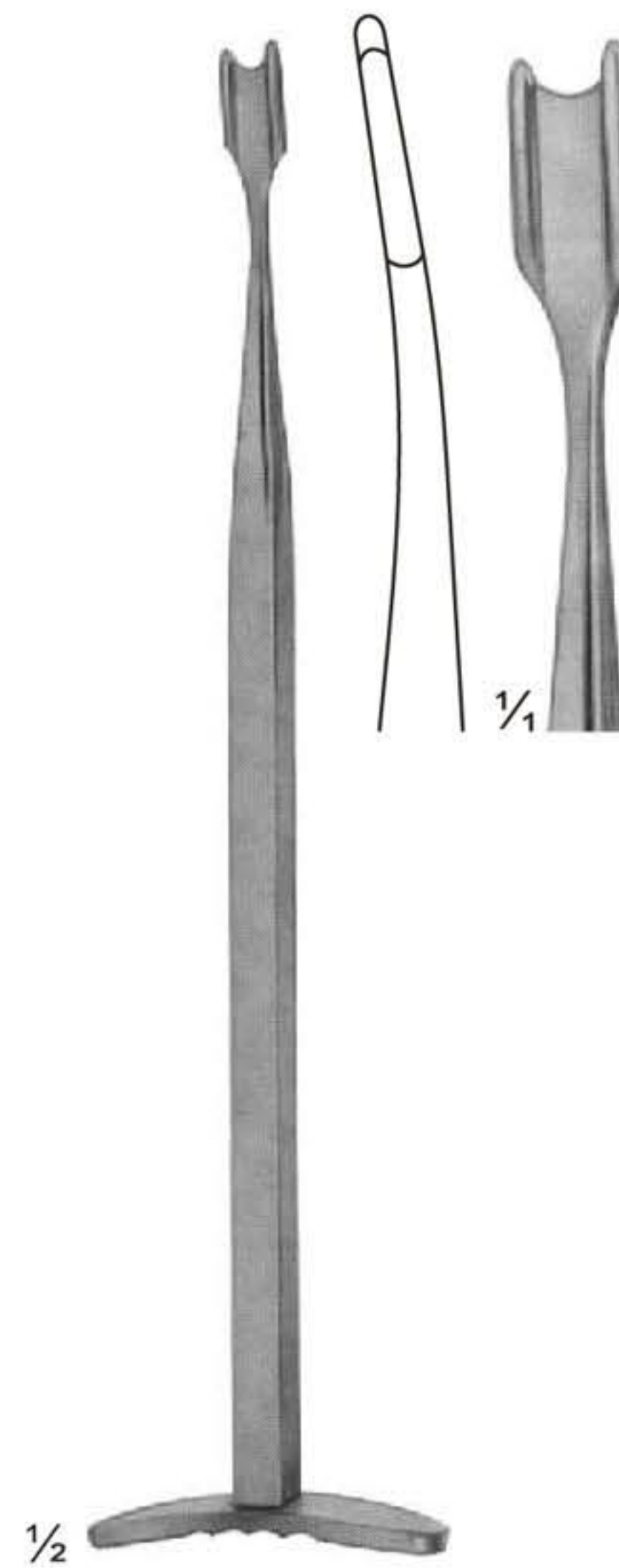

**22-207**  
SMILLIE  
170 mm

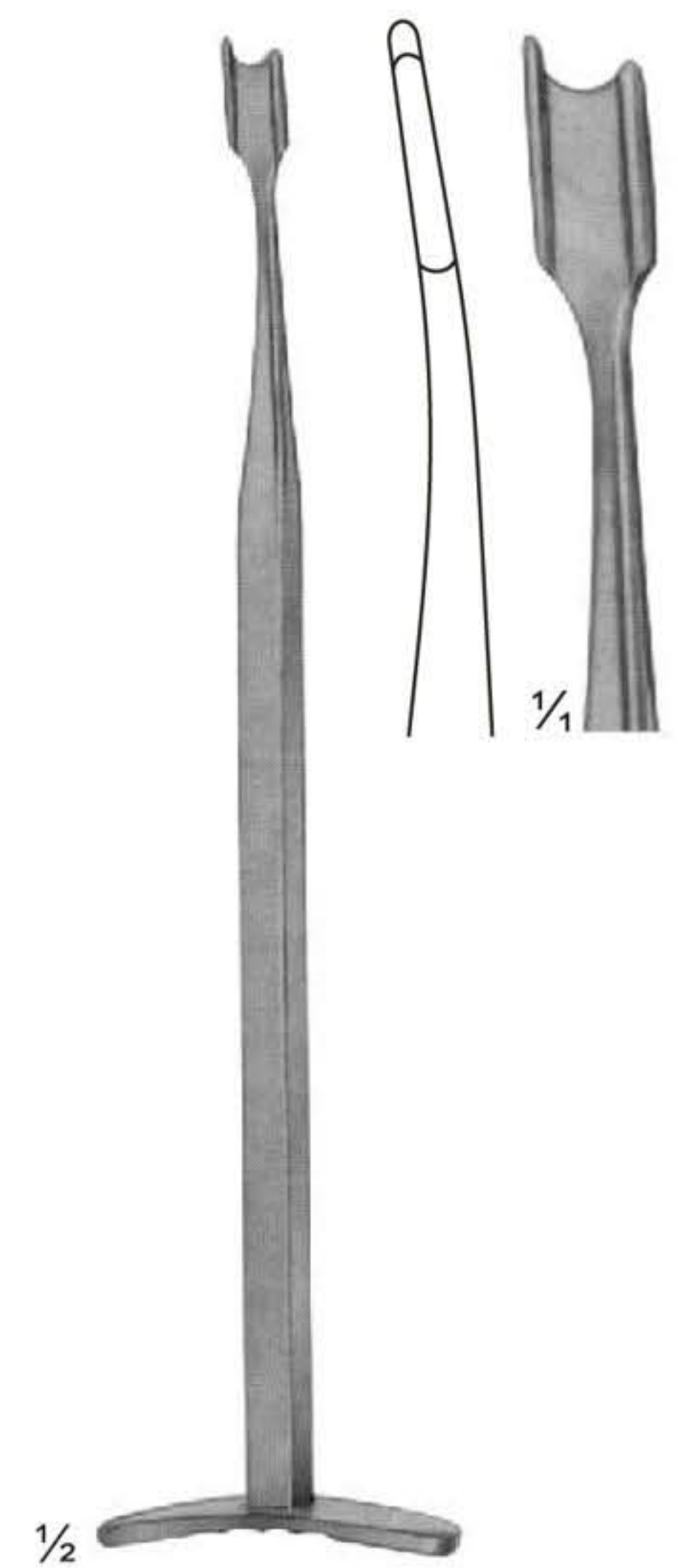

**22-208**  
SMILLIE  
170 mm



# Wire Extension

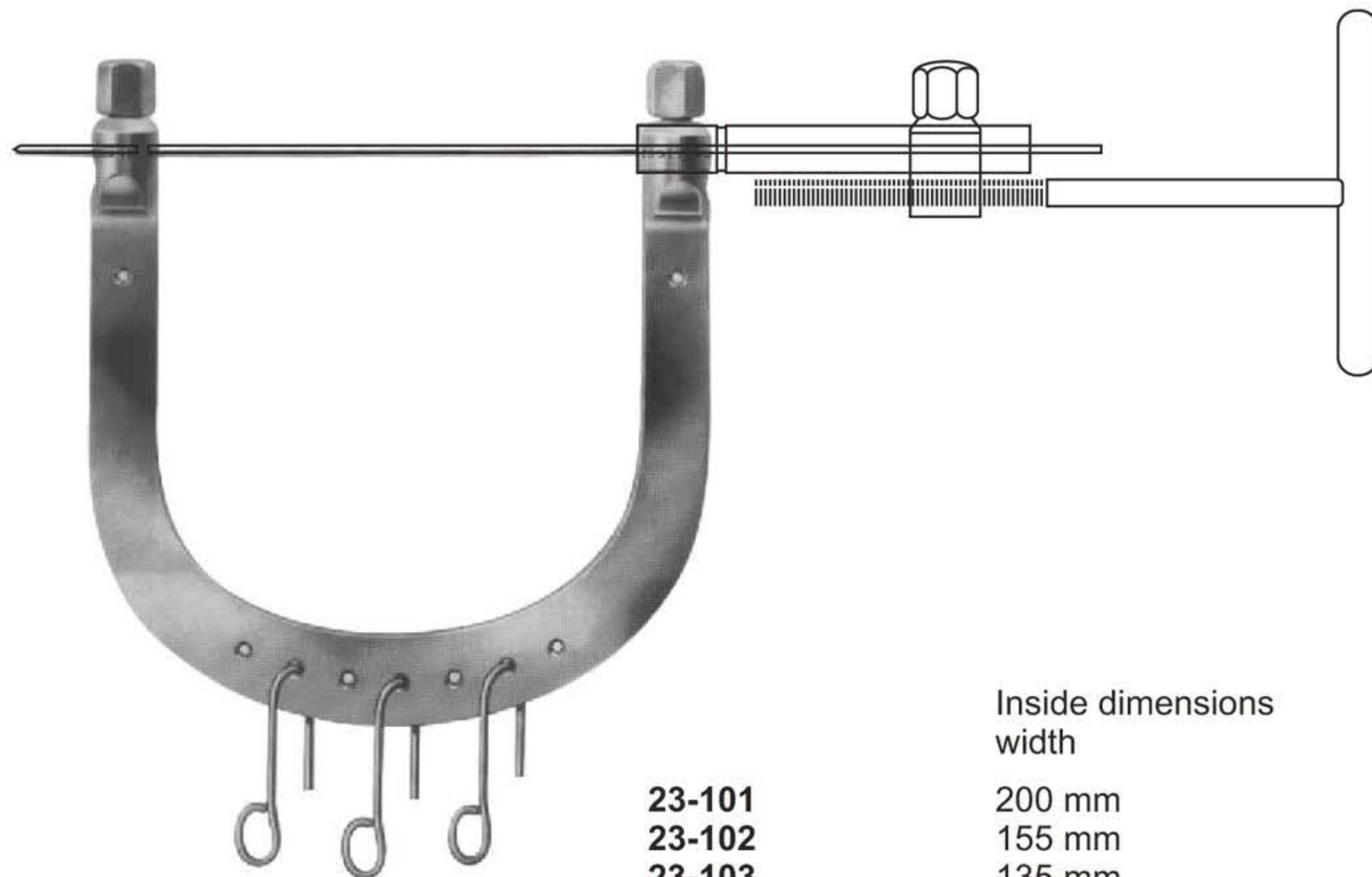

**23-101 - 107**  
**KIRSCHNER**  
 Wire traction bows,  
 to be used with  
 KIRSCHNER-wires  
 up to 2.5 mm diam.,  
 With 3 hooks,  
 stainless steel

	Inside dimensions width	depth
<b>23-101</b>	200 mm	155 mm
<b>23-102</b>	155 mm	155 mm
<b>23-103</b>	135 mm	130 mm
<b>23-104</b>	120 mm	120 mm
<b>23-105</b>	105 mm	100 mm
<b>23-106</b>	95 mm	110 mm
<b>23-107</b>	95 mm	70 mm



**23-108**  
 Wrench, double - ended,  
 for wire traction bows



**23-109**  
 Wire tightener, with  
 clamping jaws



**23-110**  
 Traction hook only,  
 large size



**23-111**  
 Traction hook only,  
 small size



**23-112**  
 Fixation clamp, to secure clamping  
 jaws of stainless steel



# Wire Extension

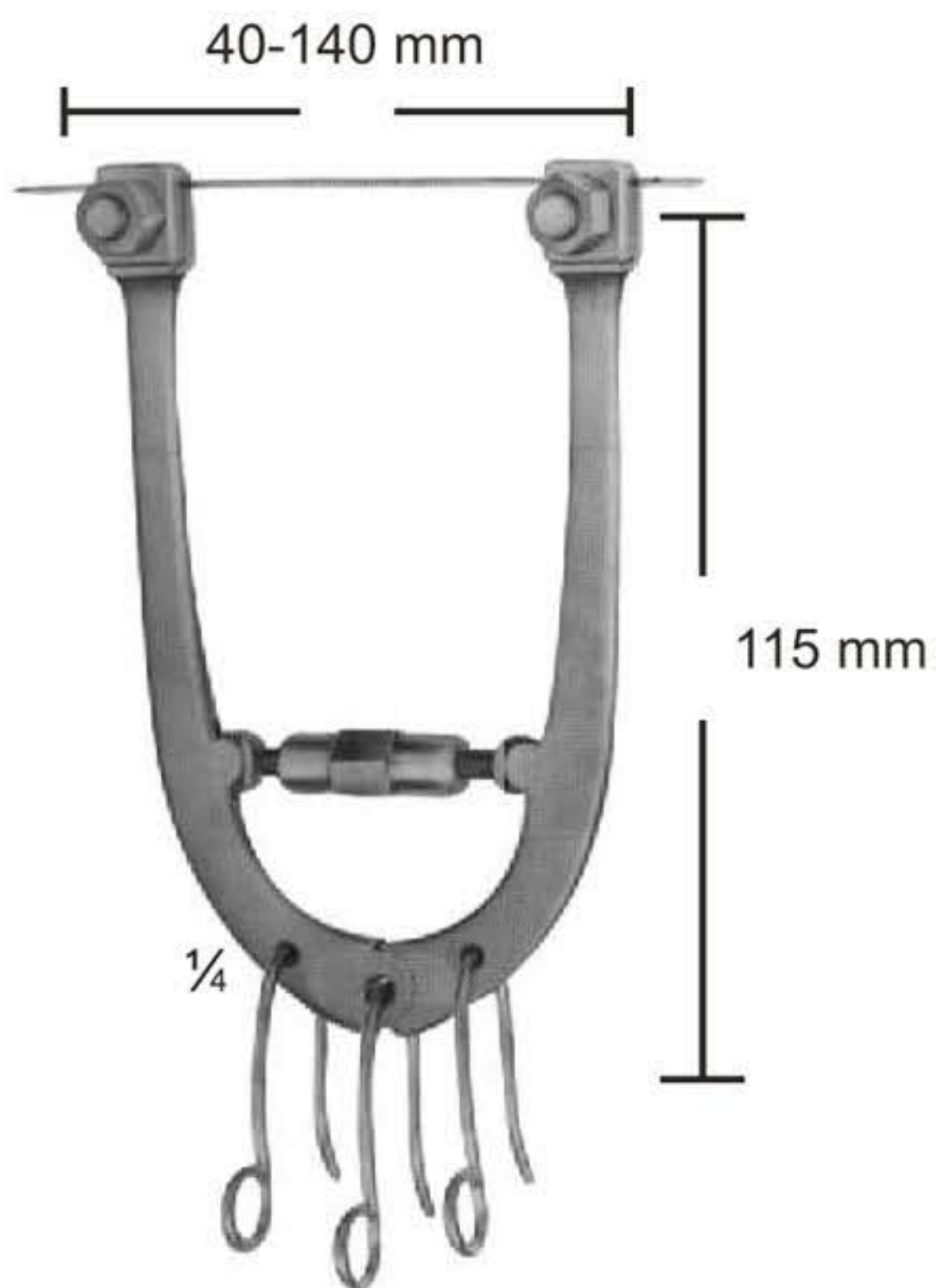

**23-113**  
Wire traction bow, adjustable, with 3 hooks, small size

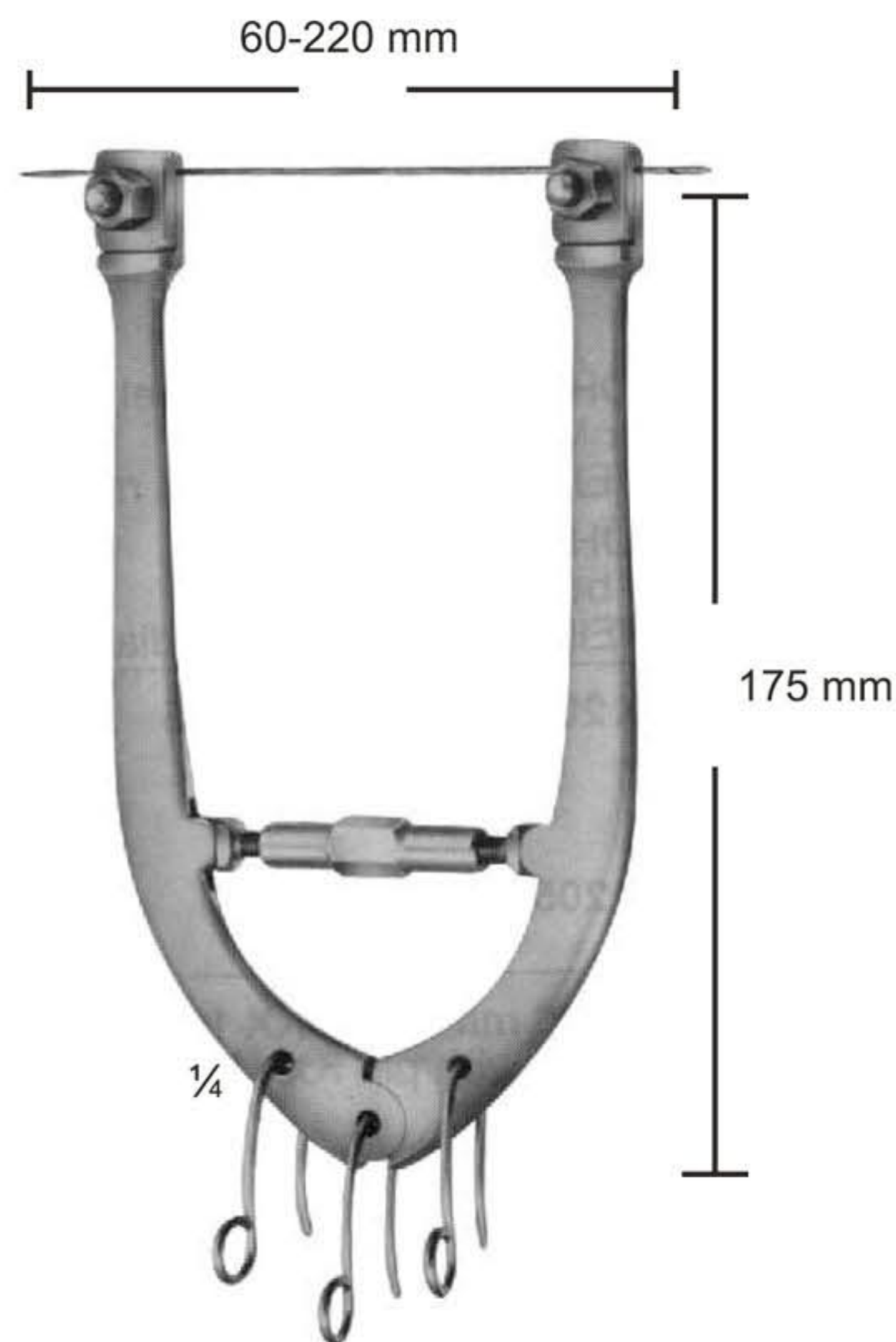

**23-114**  
Wire traction bow, adjustable, with 3 hooks, large size

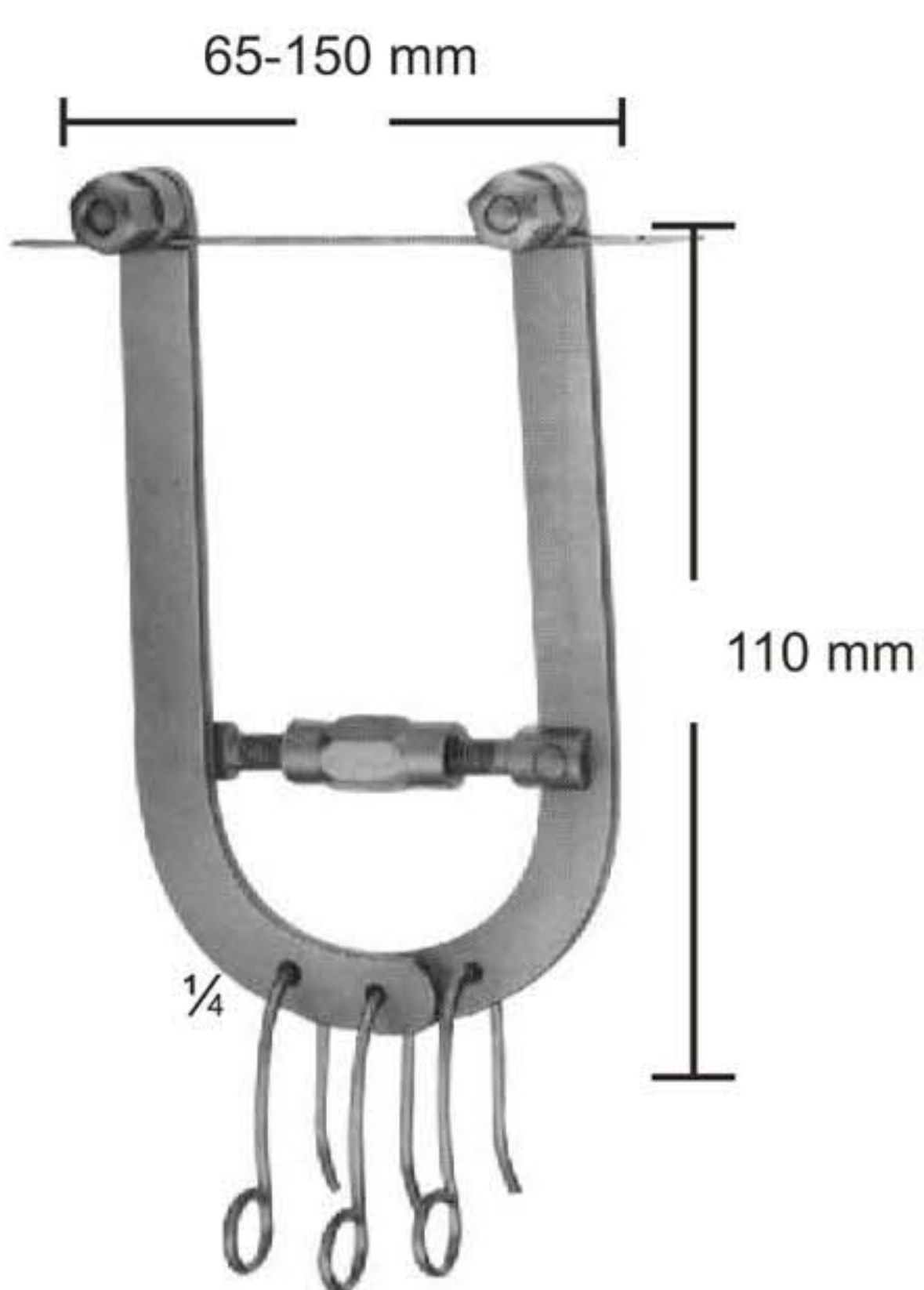

**23-115**  
Wire traction bow, adjustable, with 3 hooks, large size for elbow and calcaneus, for adolescents

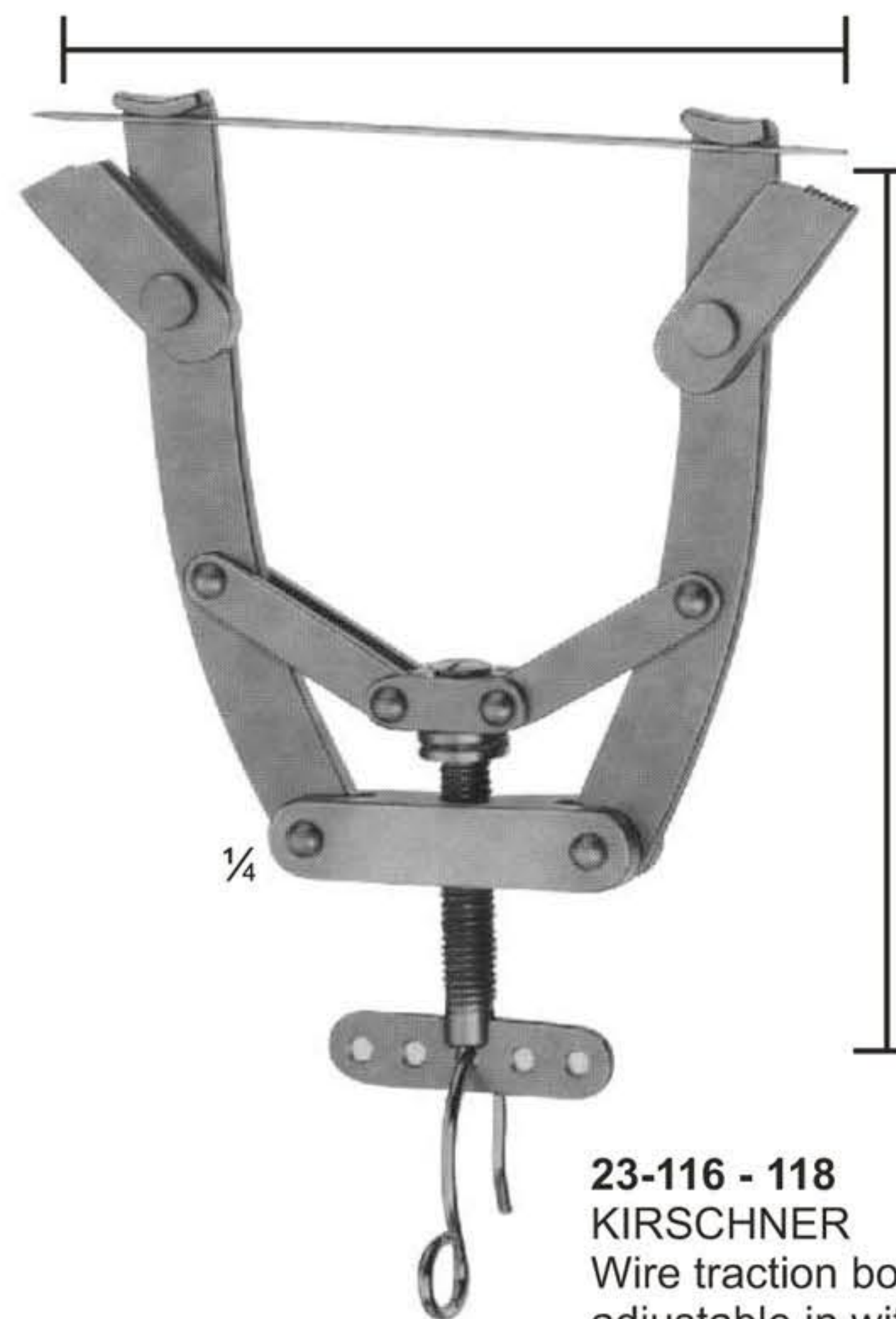

<b>23-116</b>	105 mm
<b>23-117</b>	160 mm
<b>23-118</b>	200 mm
<b>23-116</b>	1,6 mm
<b>23-117</b>	2,0 mm
<b>23-118</b>	2,5 mm

**23-116 - 118**  
**KIRSCHNER**  
Wire traction bow, modified adjustable in with width, holds wire securely, with 1 hook



**23-119**  
Fixation disc, slotted



**23-120**  
idem, aluminum, transparent to X-rays



**23-121**  
Fixation disc, slotted



**23-122**  
Screw driver, for above fixations discs



# Traction Bows, Distractor

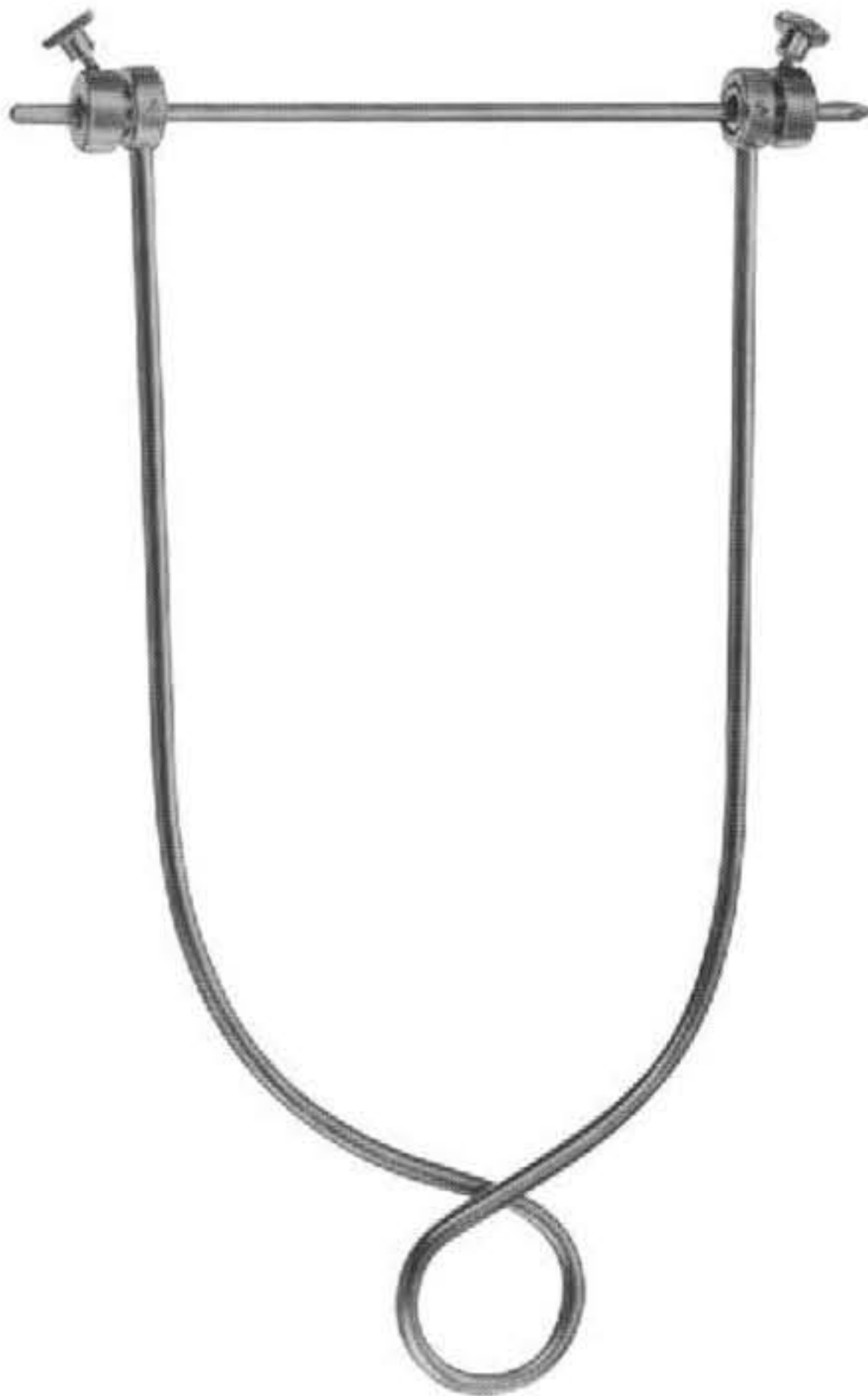

**23-123 - 130**  
 Screw driver, for above fixations discs

Steinmann pins, 4 mm daim.		Steinmann pins, 5 mm daim.	
<b>23-123</b> with pin		16x9cm	Arm
<b>23-124</b> without pin	<b>23-129</b> without		
<b>23-125</b> with pin		21x11cm	Arm
<b>23-126</b> without pin	<b>23-130</b> without		
<b>23-127</b> with pin		21x15cm	Arm
<b>23-128</b> without pin			



**23-131**  
**SCHWARZ**  
 Traction bow for fingers,  
 to be used with KIRSCHNER-  
 wire up to 1.6 mm diam.

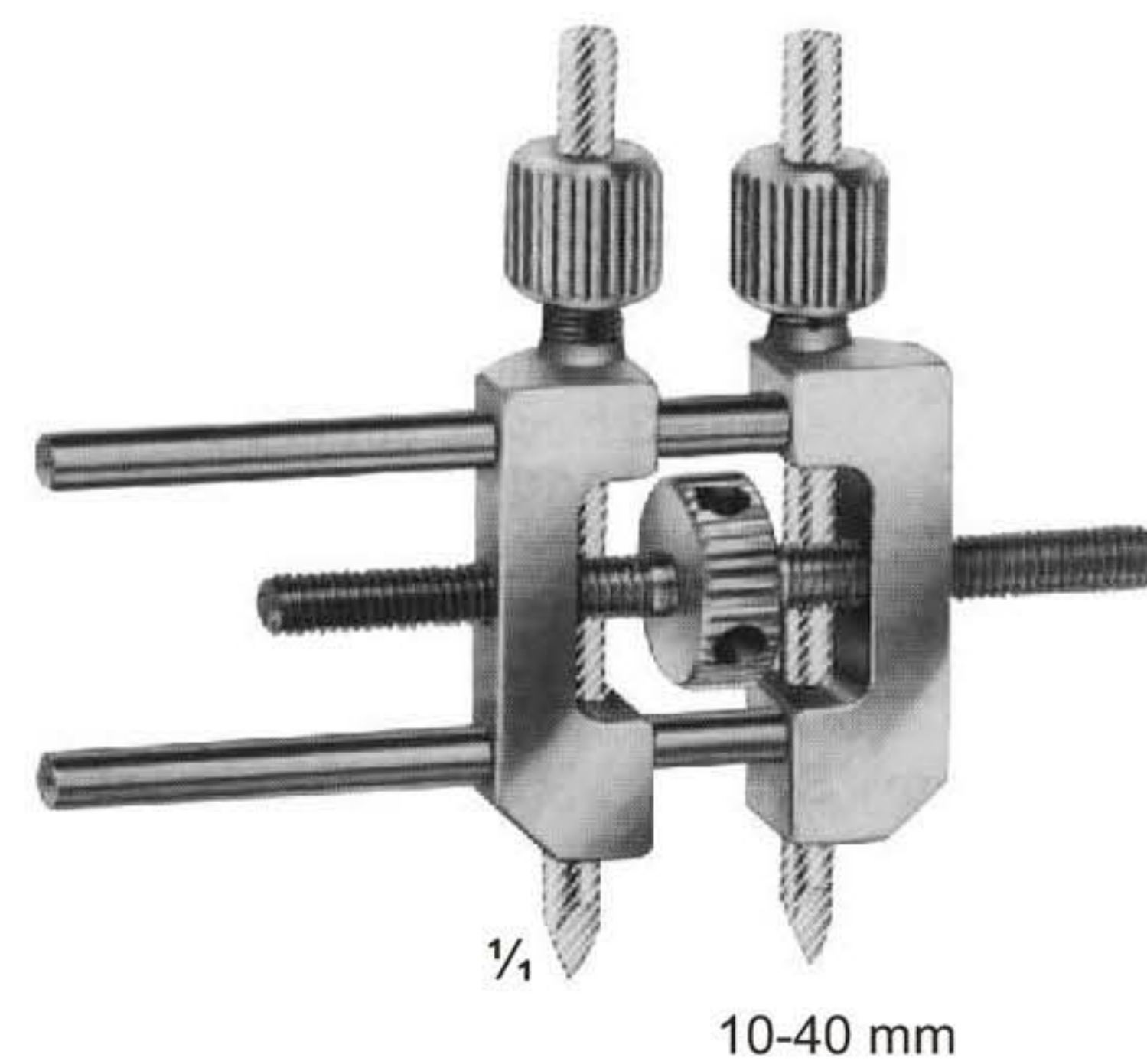

**23-132**  
 Small distractor  
 as a repositioning device for  
 distraction and compression of small bones,  
 for wires with 3.0 mm diam.



# STEINMANN Pins



**23-133 - 147**  
**STEINMANN**  
 triangular shaft ended and trocar point

Length	4,0 mm	5,0 mm
80 mm	<b>23-133</b>	
100 mm	<b>23-134</b>	
120 mm	<b>23-135</b>	
140 mm	<b>23-136</b>	
150 mm	<b>23-137</b>	<b>23-143</b>
160 mm	<b>23-138</b>	
180 mm	<b>23-139</b>	<b>23-144</b>
200 mm	<b>23-140</b>	<b>23-145</b>
210 mm	<b>23-141</b>	
250 mm	<b>23-142</b>	<b>23-146</b>
300 mm		<b>23-147</b>



¼

**23-148**  
 Protection cap  
 for 4,0 mm STEINMANN Pins



¼

**23-149**  
 Protection cap  
 for 5,0 mm STEINMANN Pins



# Drilling Chucks



1/2

**23-150**  
REILL  
Drilling chuck, cannulated, for shanks from 2.0 - 2.5 mm diam 115 mm

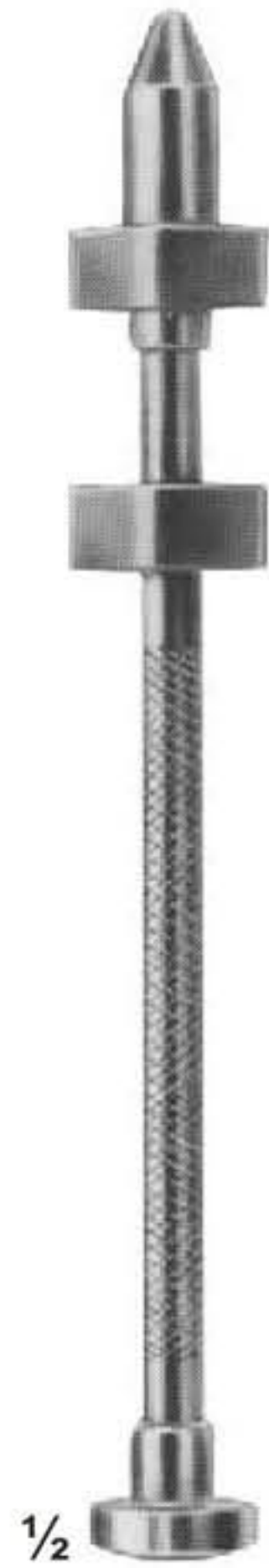

1/2

**23-151**  
Drilling chuck, cannulated, for shanks from 0.8 - 2.0 mm diam 150 mm



1/2

**23-152**  
Drilling chuck, cannulated, for shanks up to 4.5 mm diam with key 140 mm



1/2

**23-153**  
LOUTE  
Wire tightener, improved pattern, with movable tip, for wires up to 1.0 mm diam. 220 mm



1/2

**23-154**  
Drilling chuck, cannulated, for shanks up to 6.35 mm diam., To be tightened by hand 100 mm



1/2

**23-155**  
Drilling chuck, cannulated, for shanks up to 4.5 mm diam., And for triangular shaft width across flats 4.7 mm



1/2

**23-156**  
Drilling chuck, cannulated, for shanks up to 6.35 mm diam., With key 160 mm



**Cerclage Instruments**

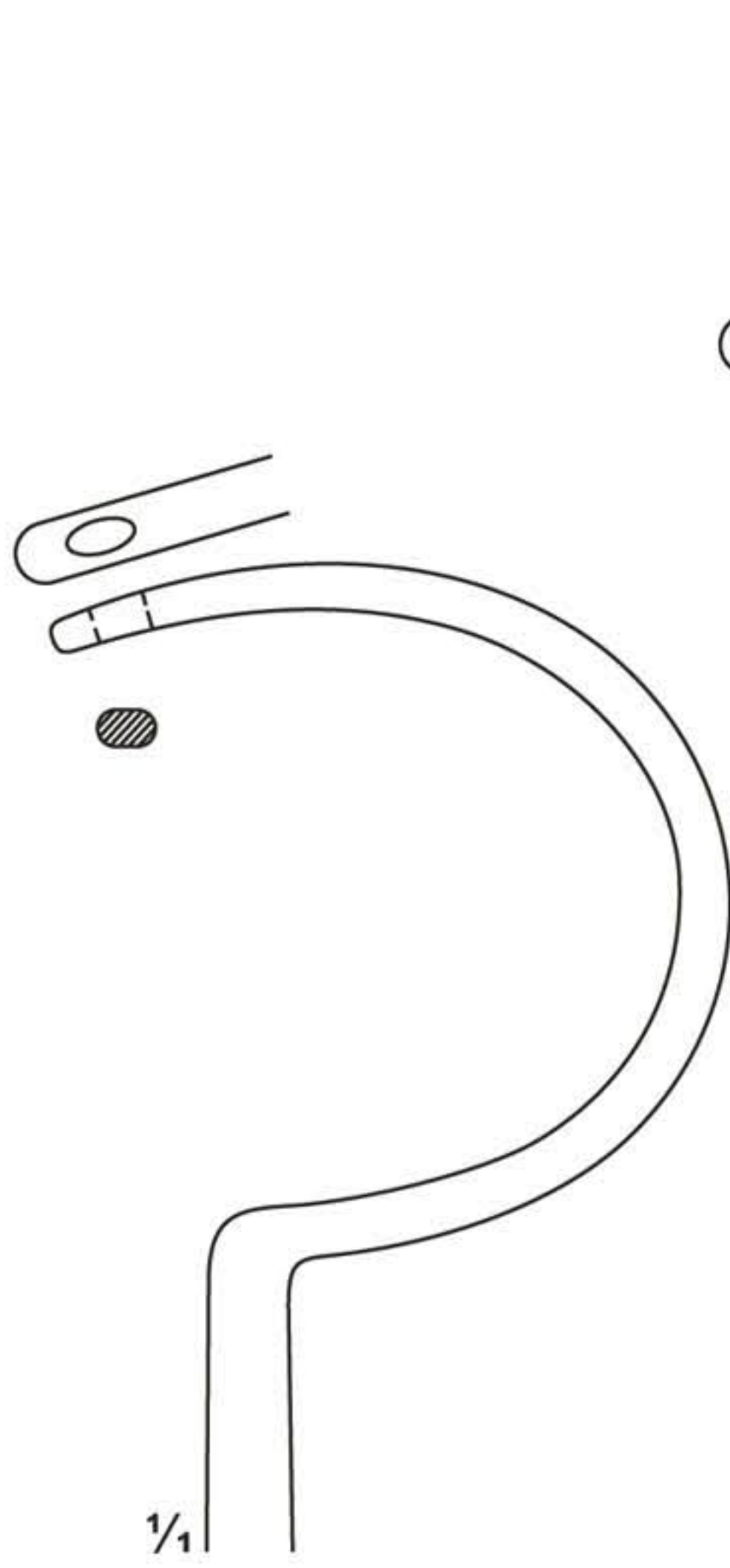

**23-157**  
275 mm

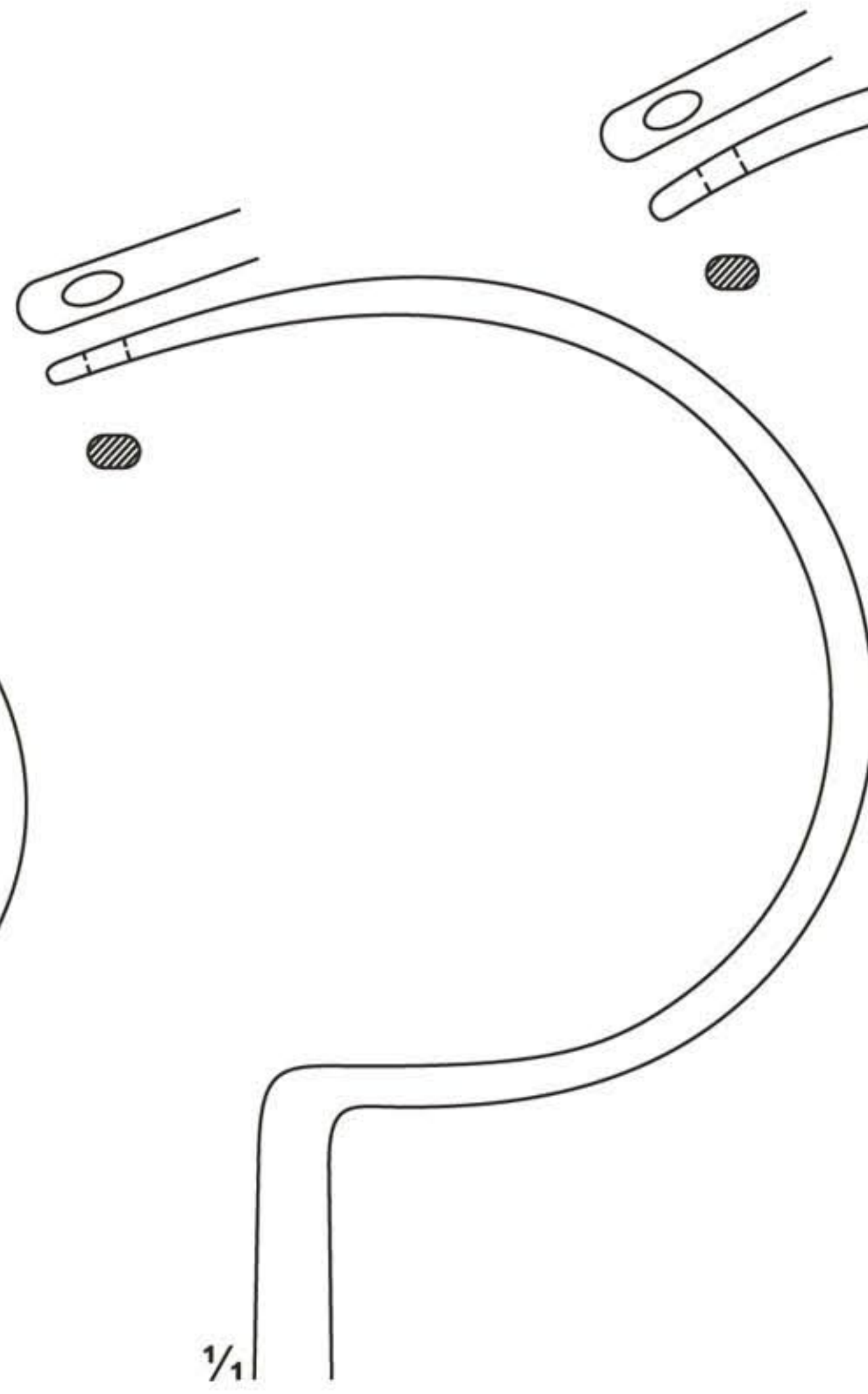

**23-158**  
285 mm

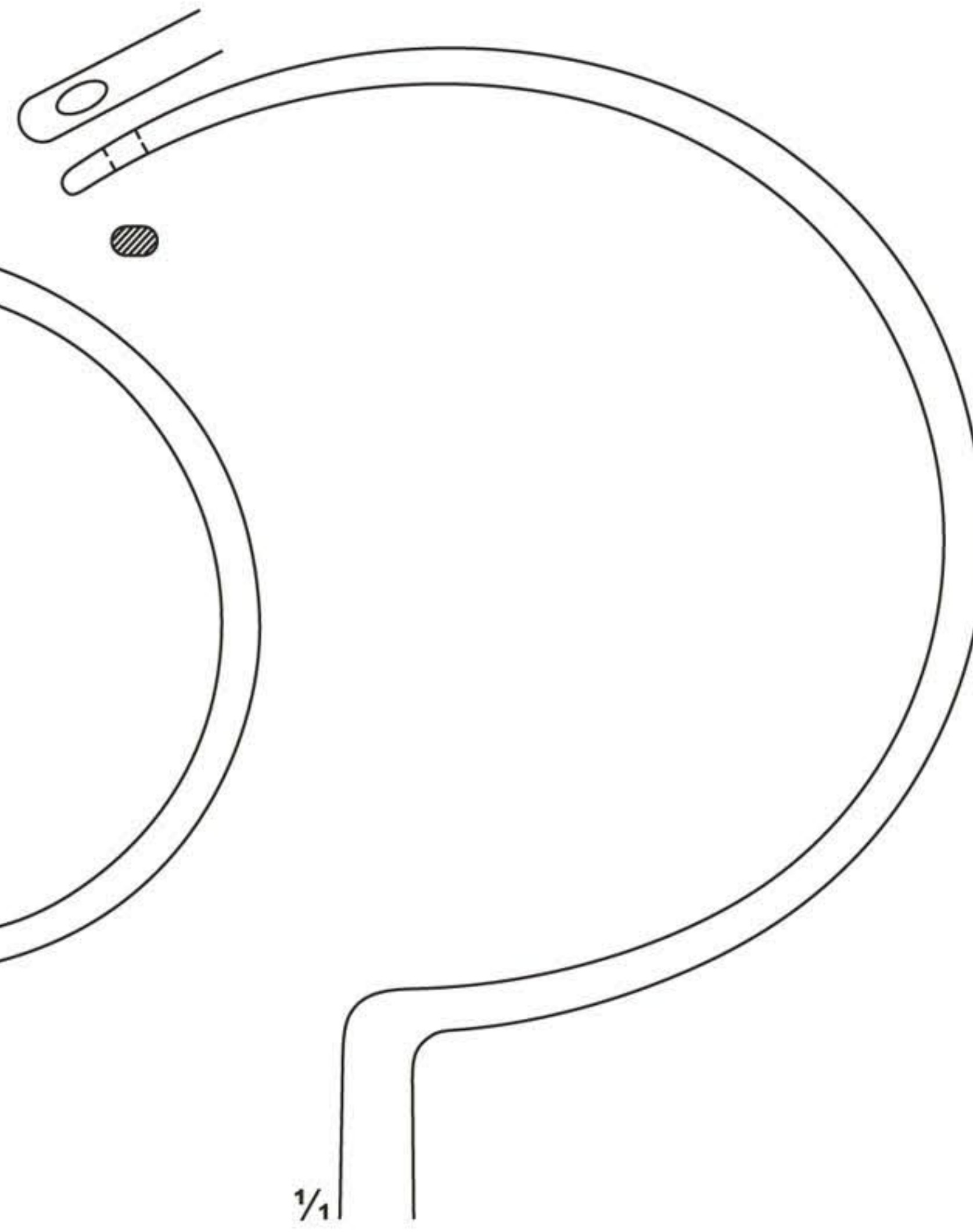

**23-159**  
305 mm



**23-157 - 159**  
DEMEL  
Wire guides

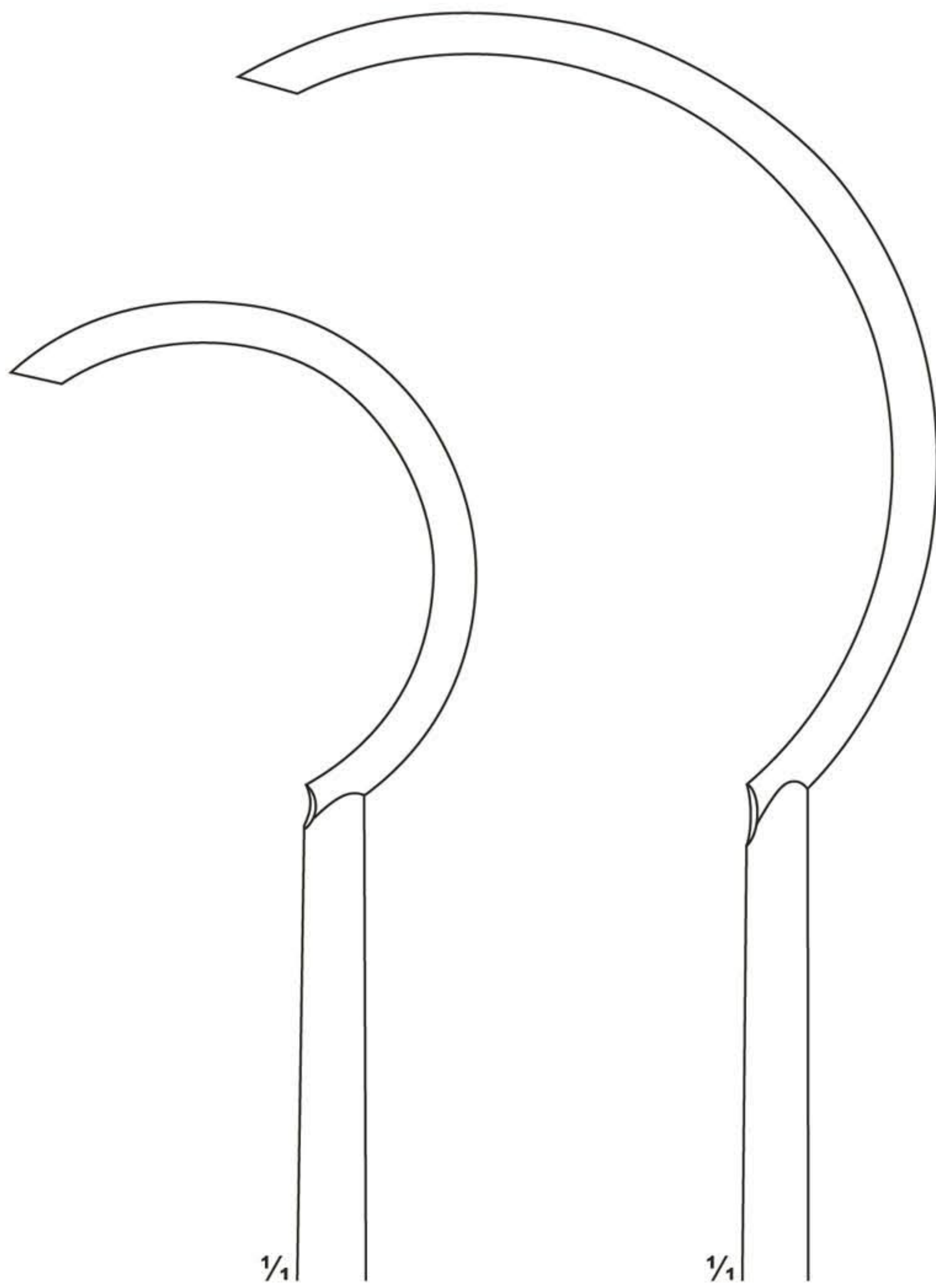

**23-160**  
240 mm

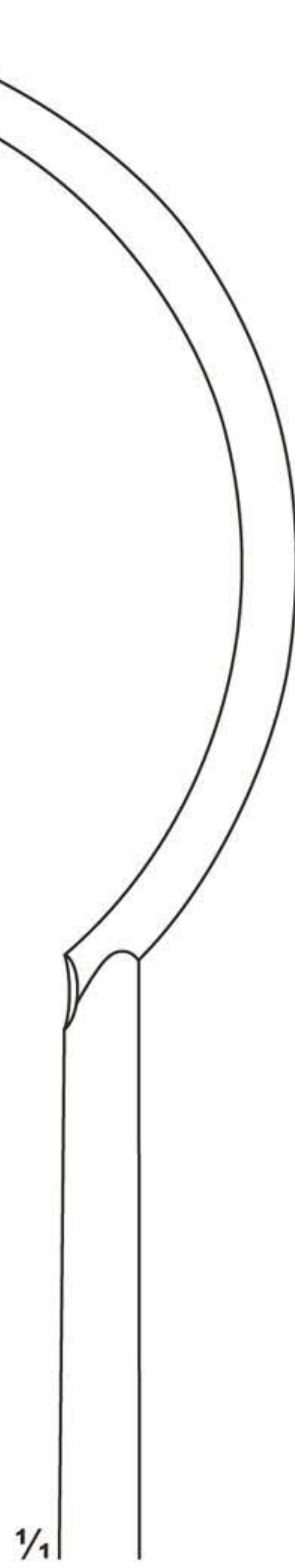

**23-161**  
270 mm

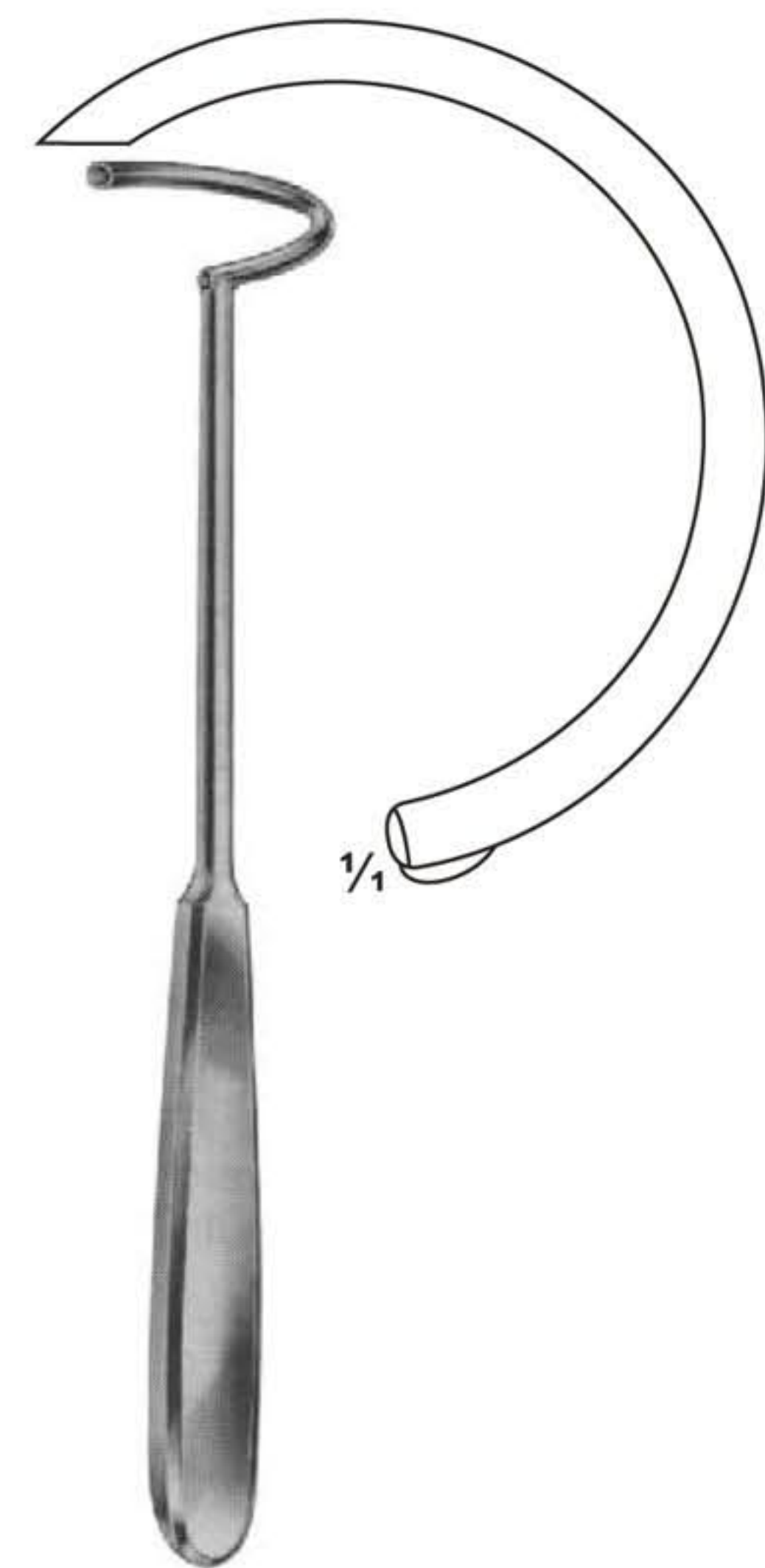

**23-162**  
225 mm



## JORDAN instruments for subcutaneous Tibia Cerclage

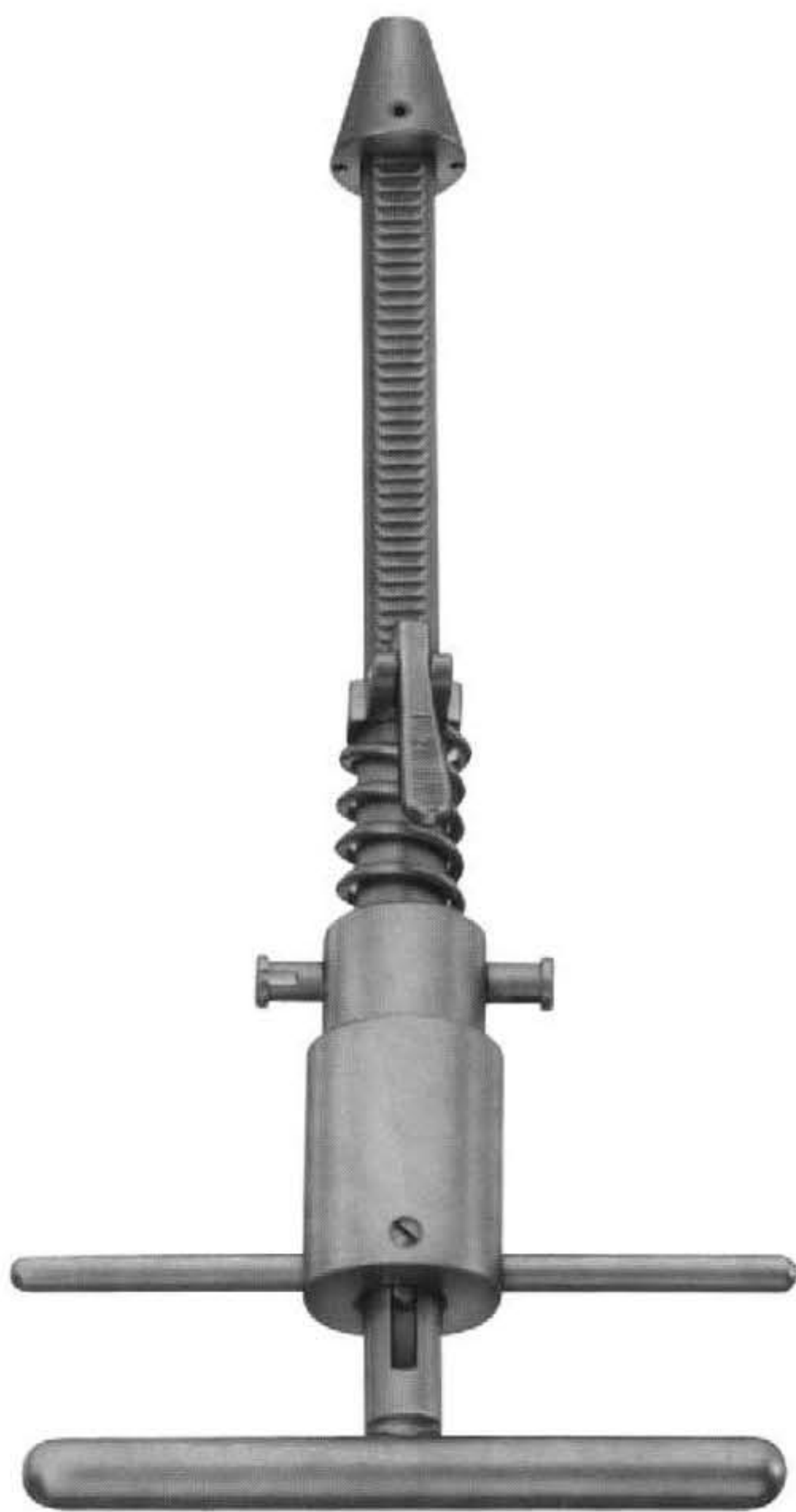

**23-163**  
JORDAN  
Wire tightener



1/2

**23-164**  
JORDAN  
Wire twister  
170 mm



1/2

**23-165**  
JORDAN  
Wire catcher  
180 mm



1/2

**23-166**  
JORDAN  
Probe, cannulated  
170 mm



**Wire Holding forceps, Wire Tightening Pliers, Flat-nosed Pliers**

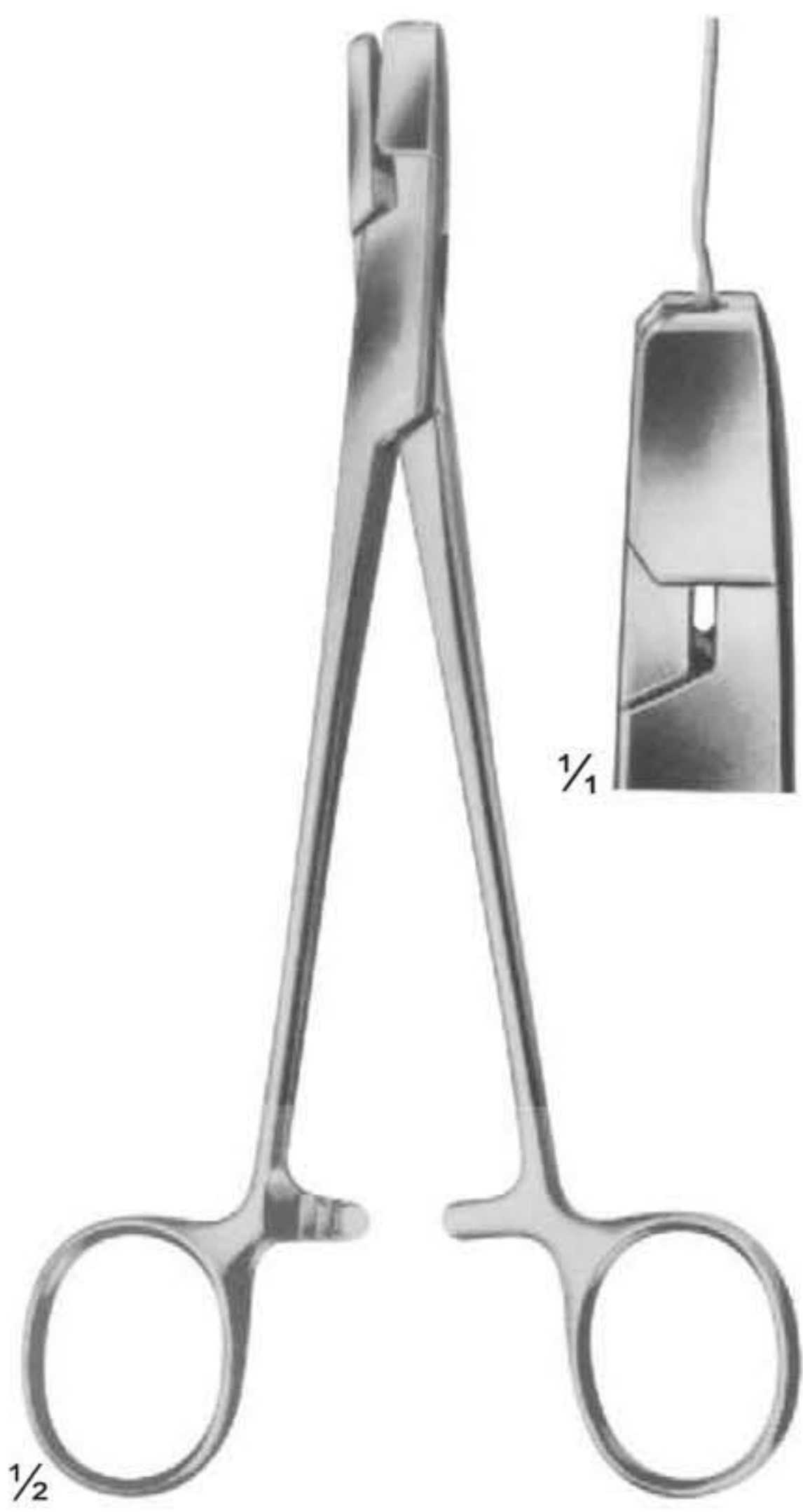

**23-167**  
DUROGRIP  
Holding forceps for cerclage wire, with lateral jaws to avoid wire slipping off  
170 mm



**23-168**  
DUROGRIP  
Wire, tightening pliers,  
Ligature pliers  
150 mm



**23-169**  
DUROGRIP  
Wire, tightening pliers,  
Ligature pliers  
150 mm



**23-170**  
with serrated jaws  
140 mm



**23-171**  
one jaws smooth,  
one jaws serrated  
140 mm



**23-172**  
with serrated jaws  
**23-173**  
with longitudinal and  
transversal grooves  
170 mm

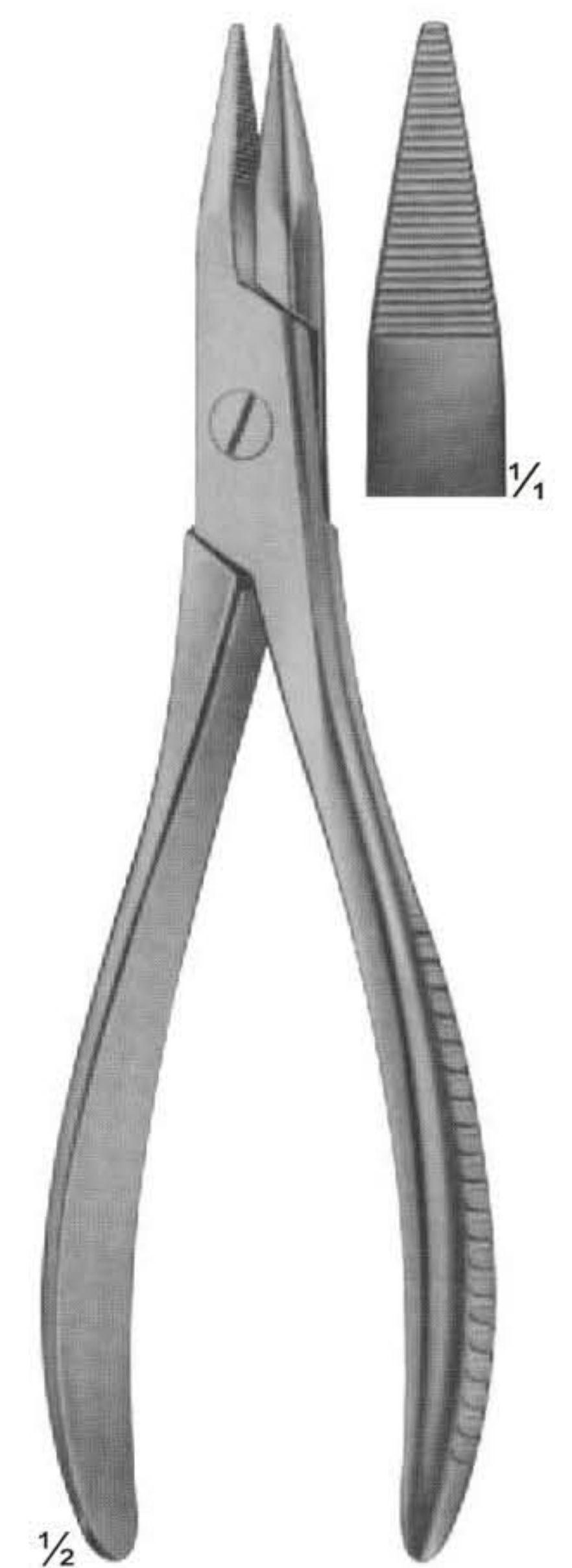

**23-174**  
190 mm



**Wire Holding forceps, Flat-nosed Pliers,  
Pliers for bending and cutting wires**

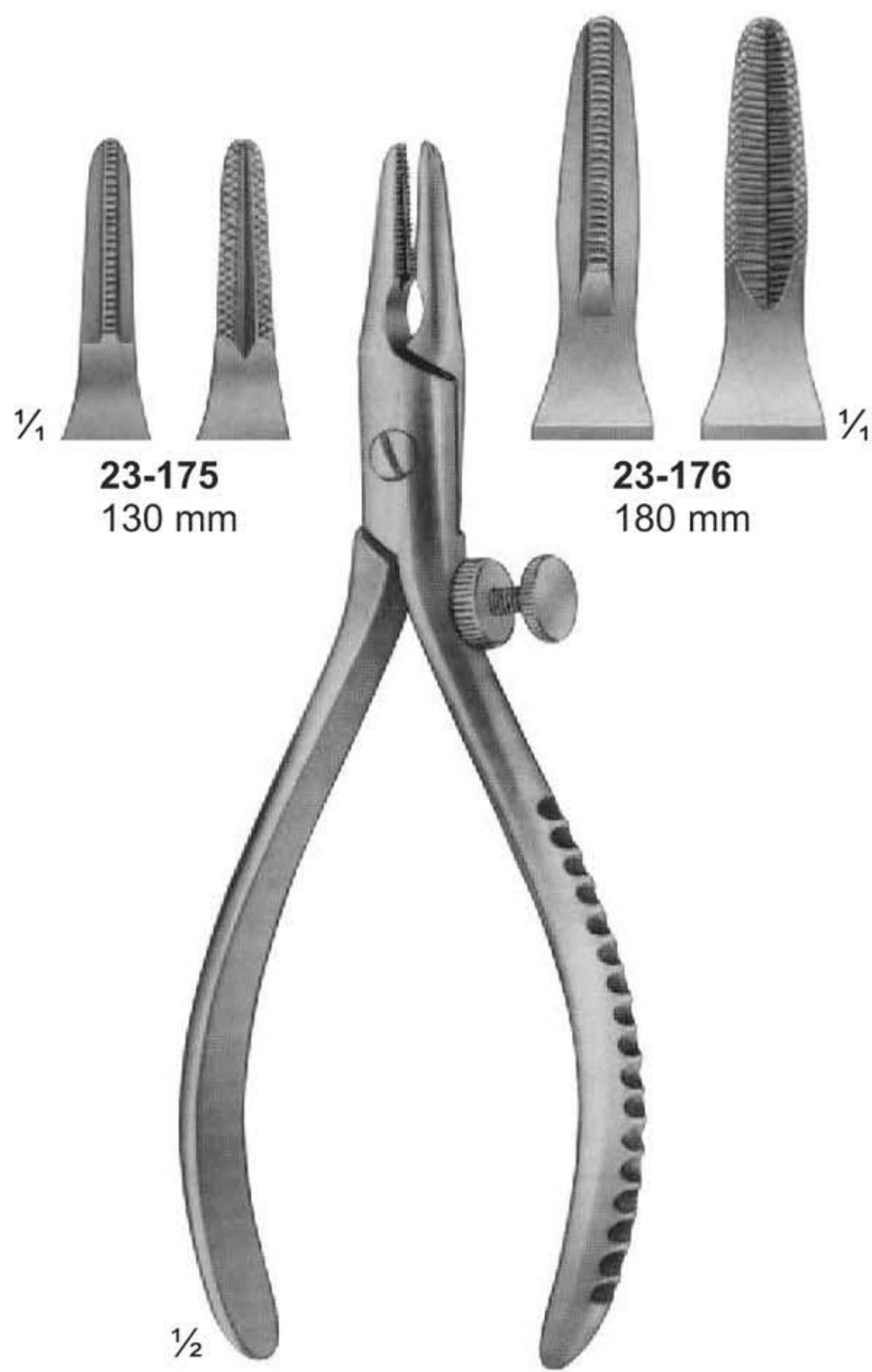

**23-175 - 176**  
Extraction pliers  
for boring wires

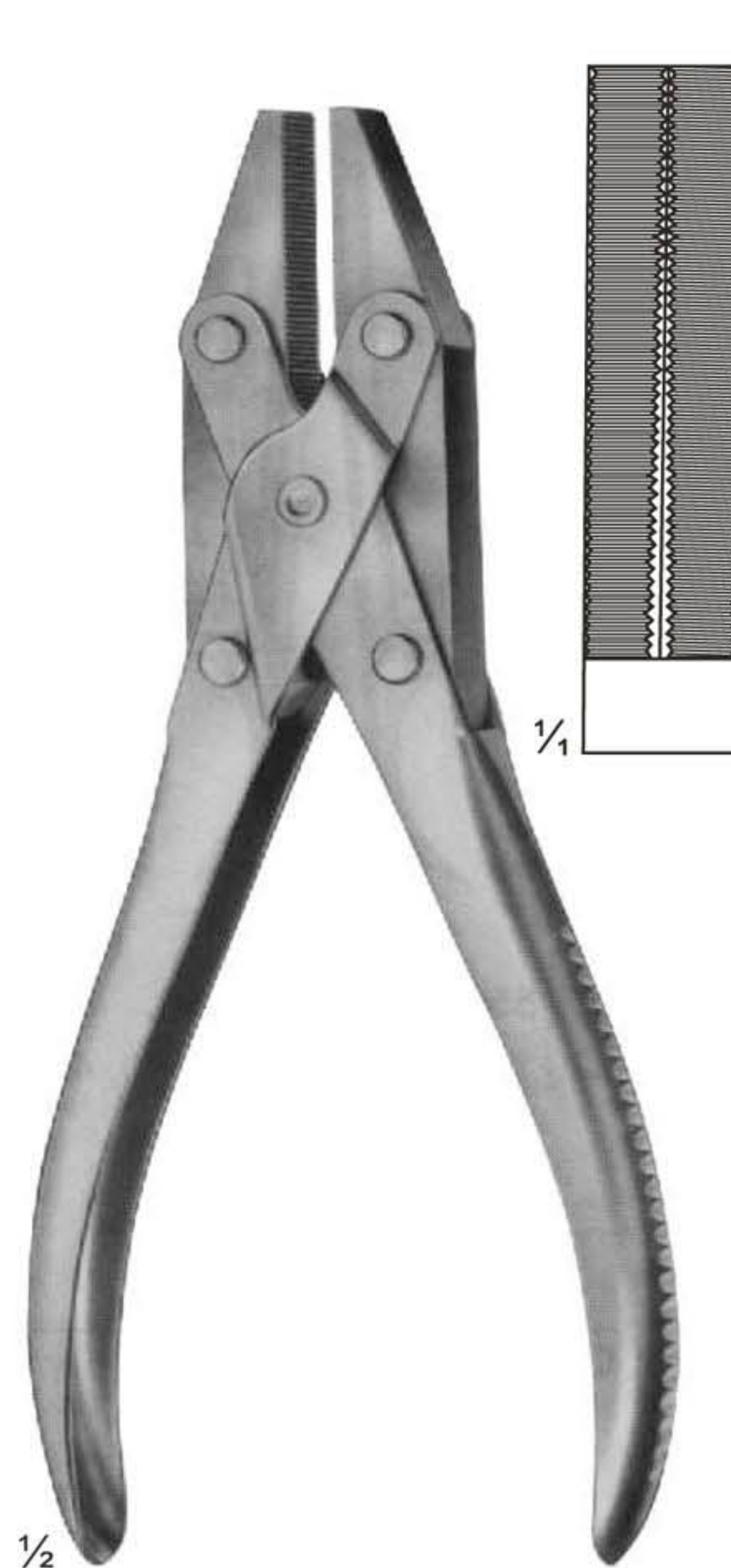

**23-177**  
Flat-nosed pliers,  
parallel  
185 mm

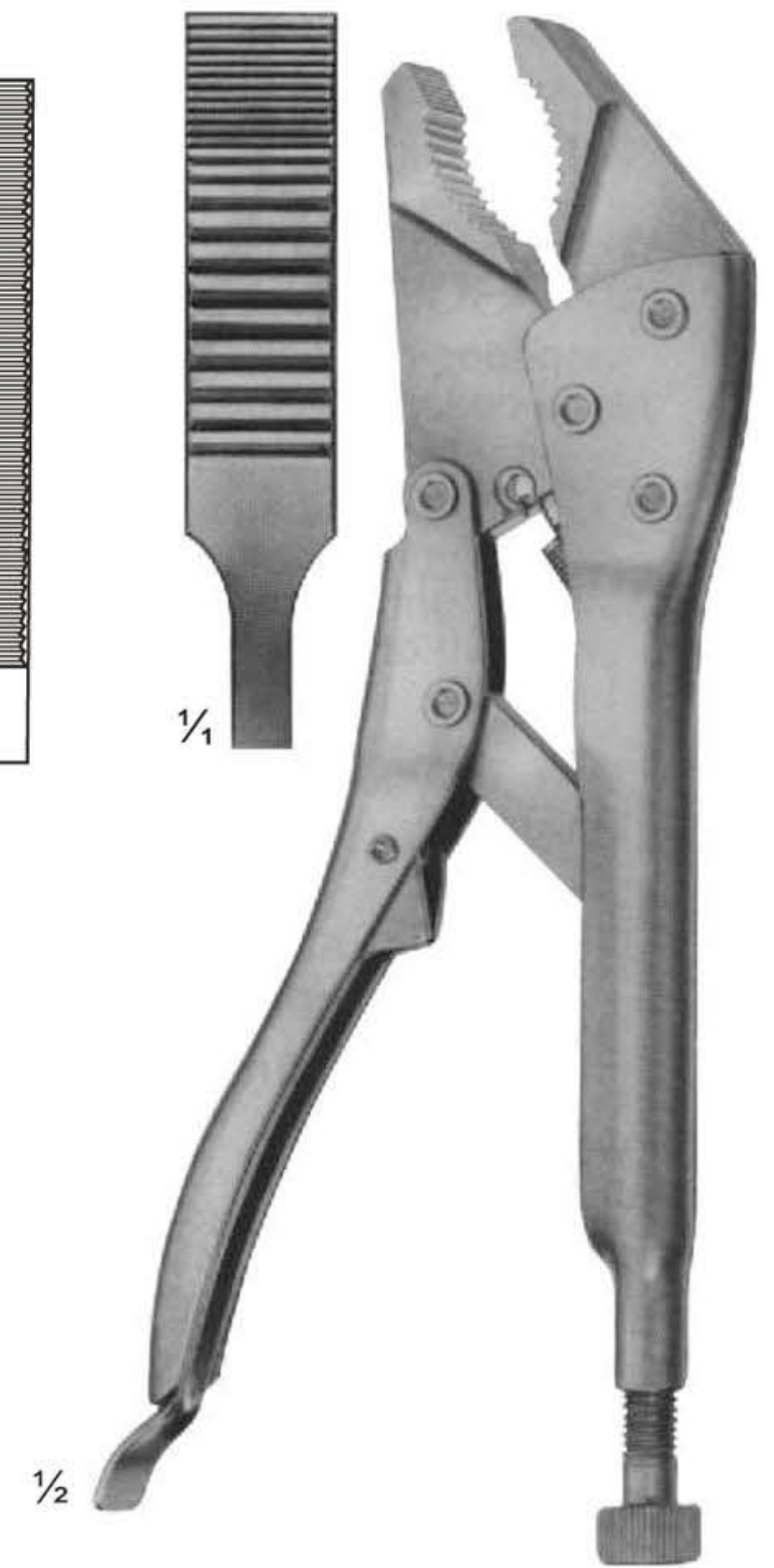

**23-178**  
Vise grip  
200 mm

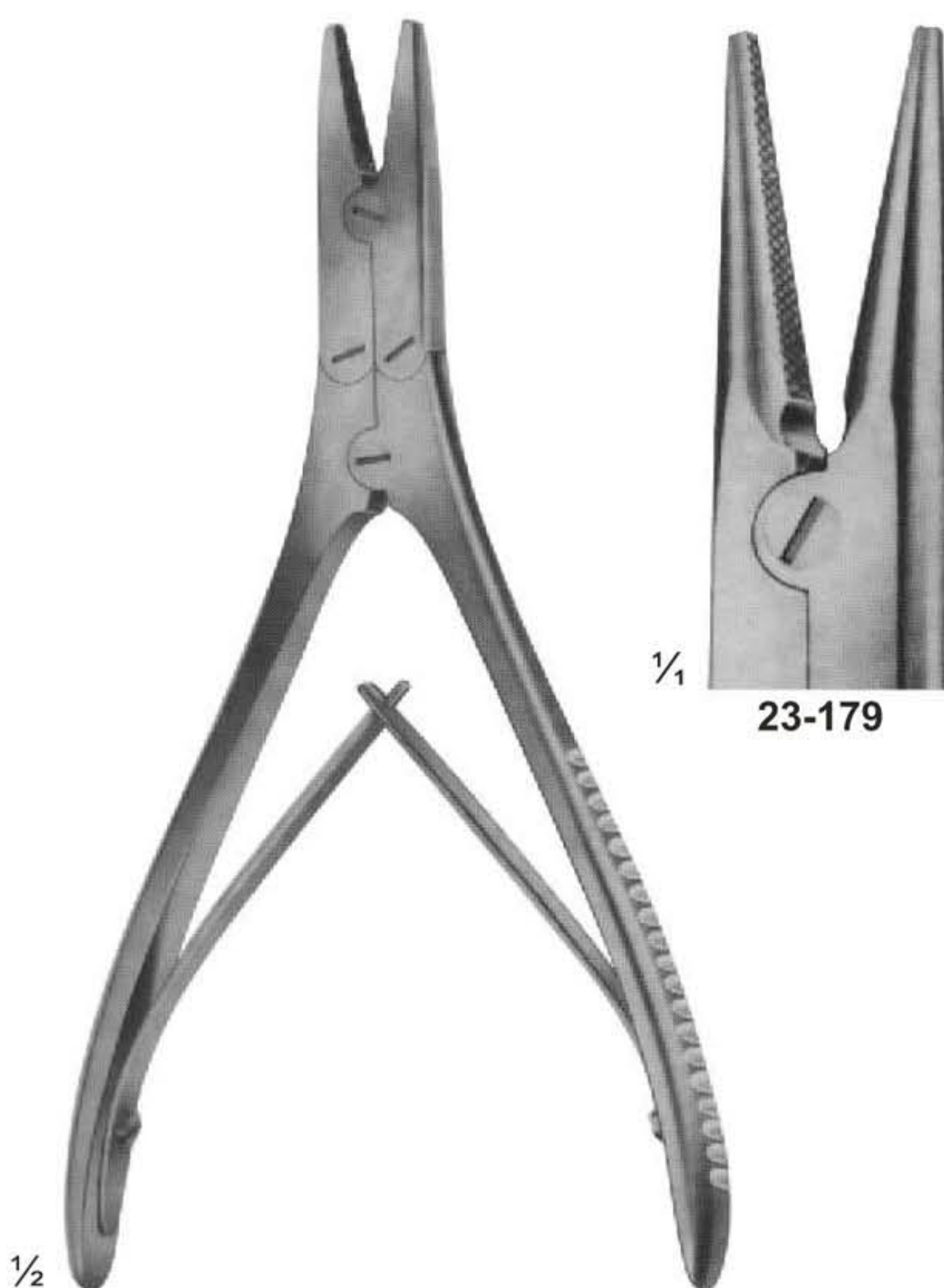

**23-179 - 183**  
Round pliers  
180 mm

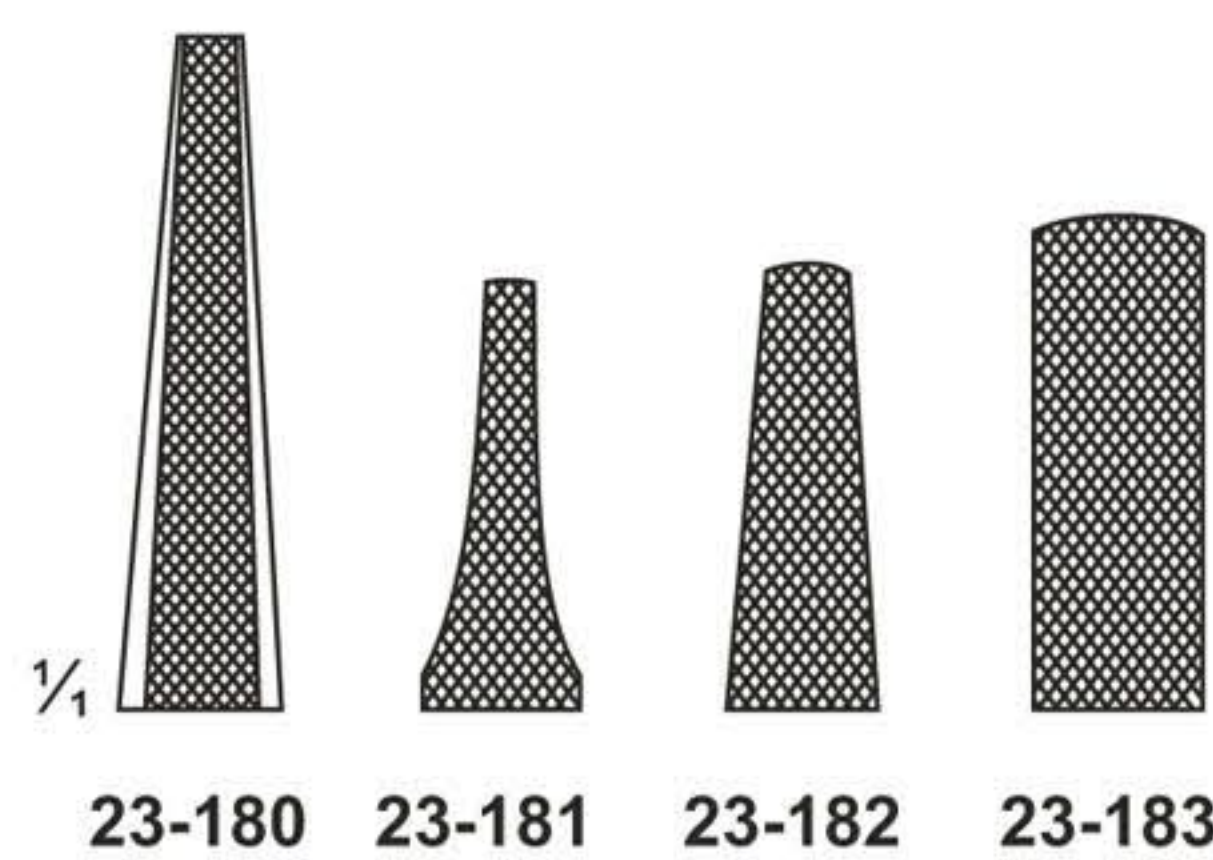

**23-180**  
**23-181** 145 mm  
**23-182** 180 mm  
**23-183** 180 mm  
Extraction pliers for wires

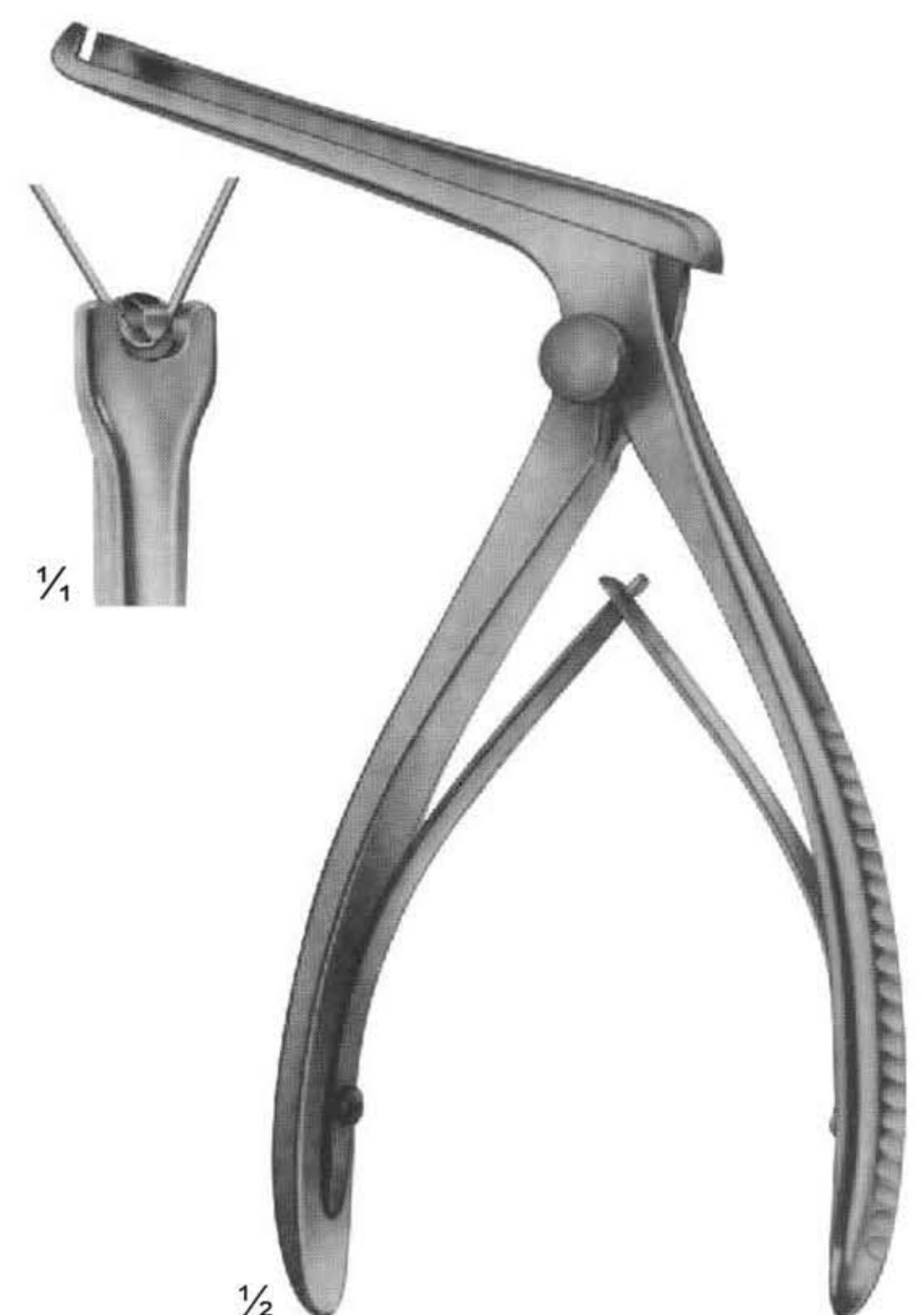

**23-184**  
Bending pliers  
for wires up to  
1.8 mm diam.



# Wire Cutters and wire Cutting Scissors



**23-185**  
 ANGLE  
 130 mm

for soft wire  
 up to diam.  
 for hard wire  
 up to diam.

**23-186**  
 DUROTIP  
 ANGLE  
 130 mm

0,5 mm 0,6 mm  
 0,3 mm 0,4 mm

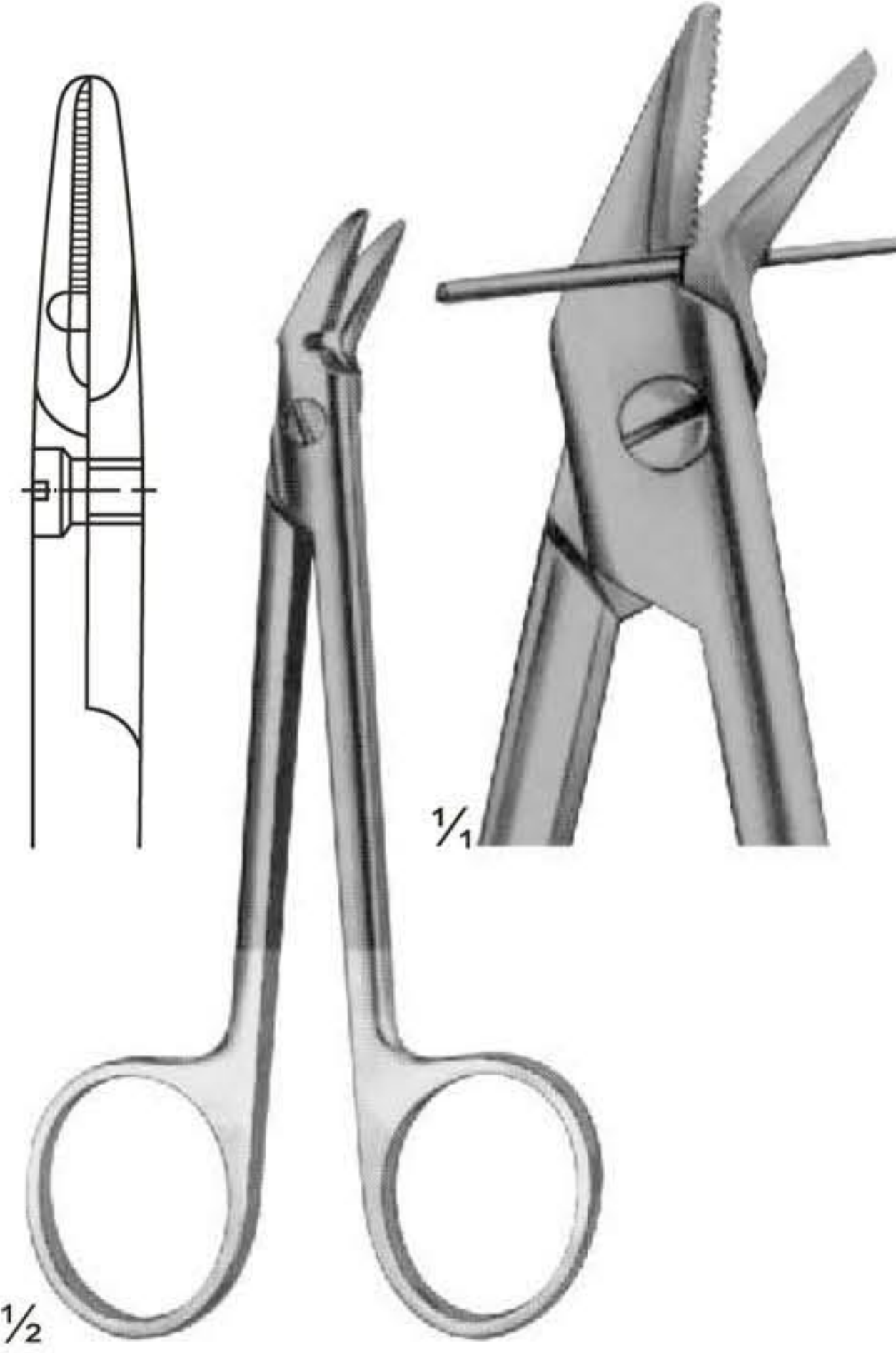

**23-187**  
 120 mm

for soft wire  
 up to diam.  
 for hard wire  
 up to diam.

**23-188**  
 DUROTIP  
 120 mm

1,2 mm 1,2 mm  
 0,8 mm 0,8 mm

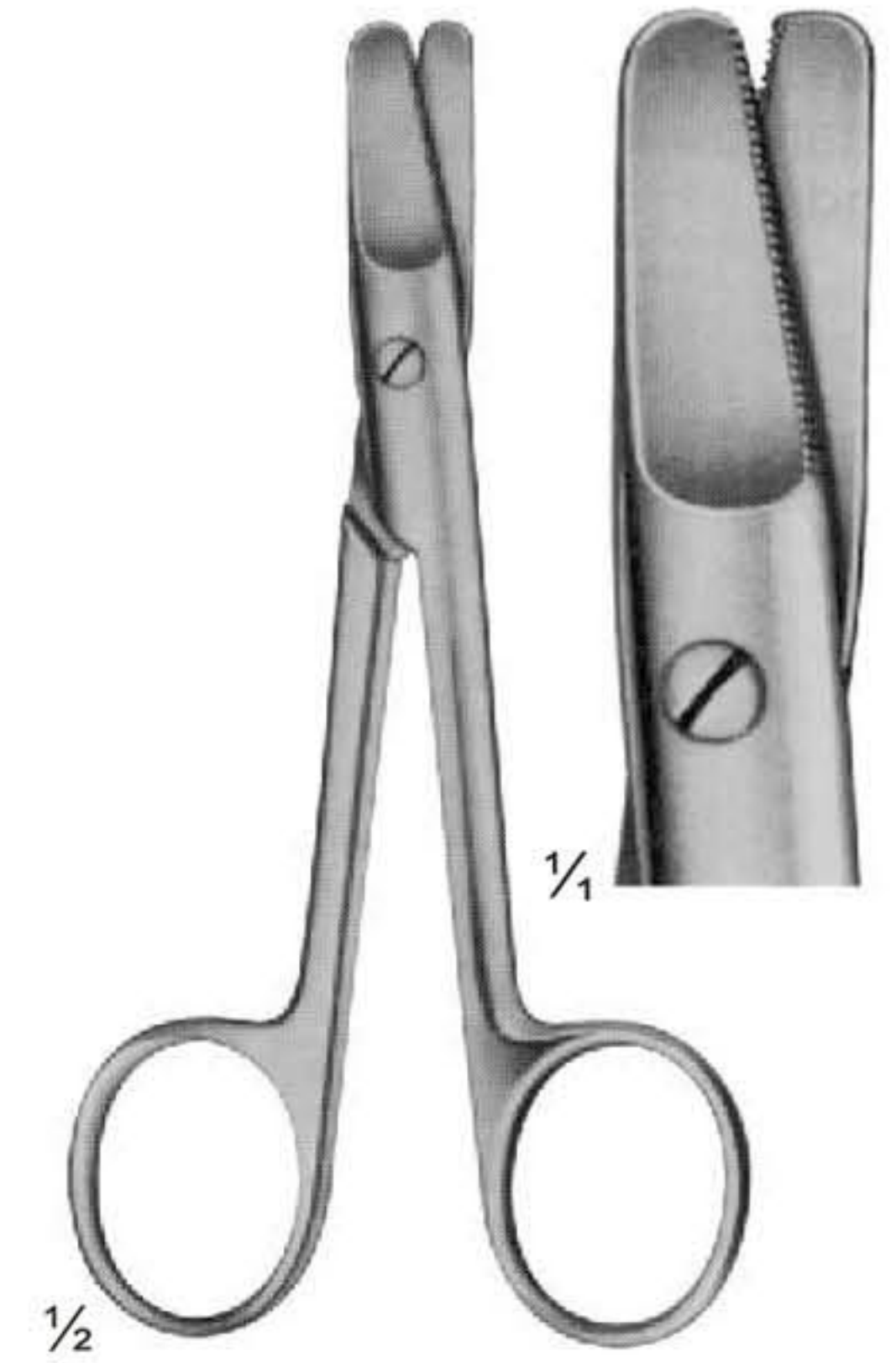

**23-189**  
 HARVEY  
 125 mm

0,4 mm  
 0,3 mm

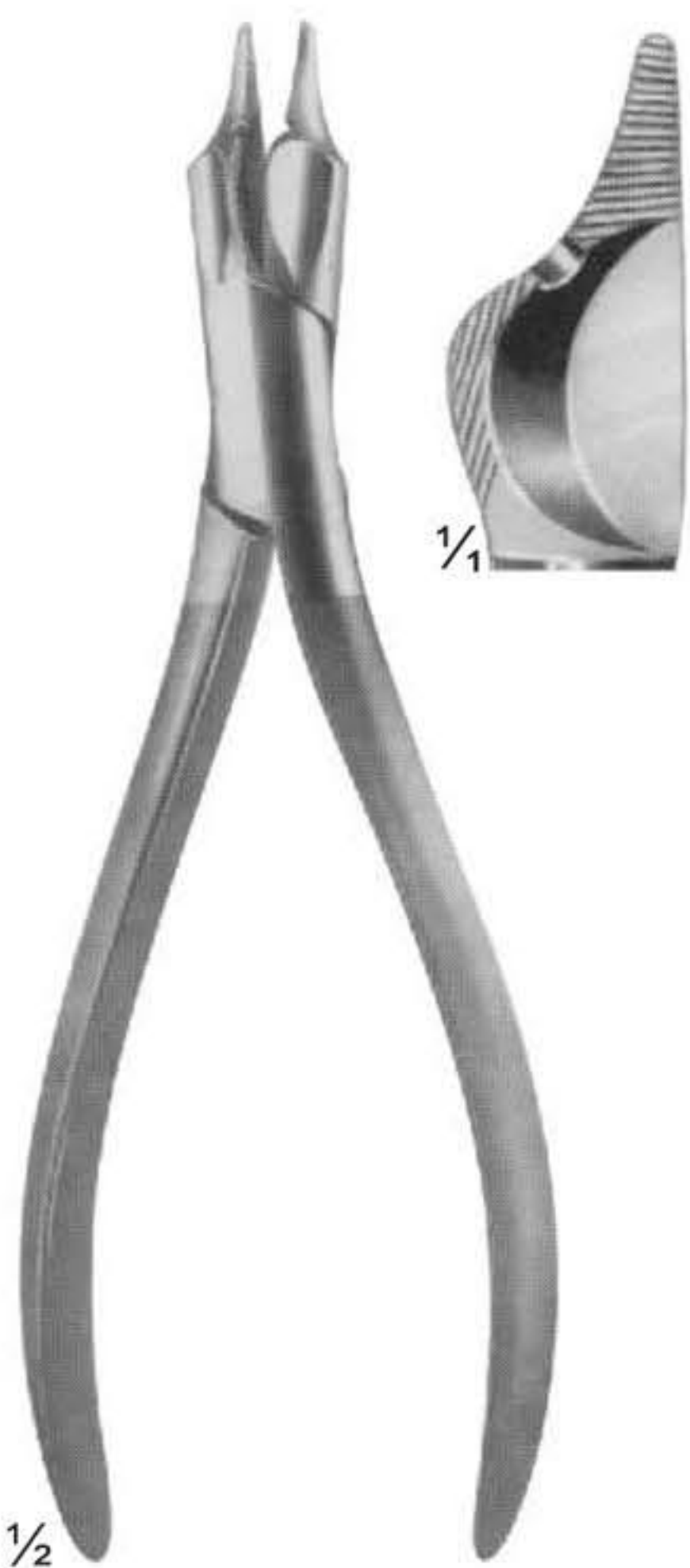

**23-190**  
 150 mm

for soft wire  
 up to diam  
 for hard wire  
 up to diam

1,5 mm  
 1,0 mm



**23-191**  
 160 mm

1,5 mm  
 1,2 mm



**23-192**  
 140 mm

1,5 mm  
 1,0 mm



## Wire Cutting Pliers, Lateral Cutting Action

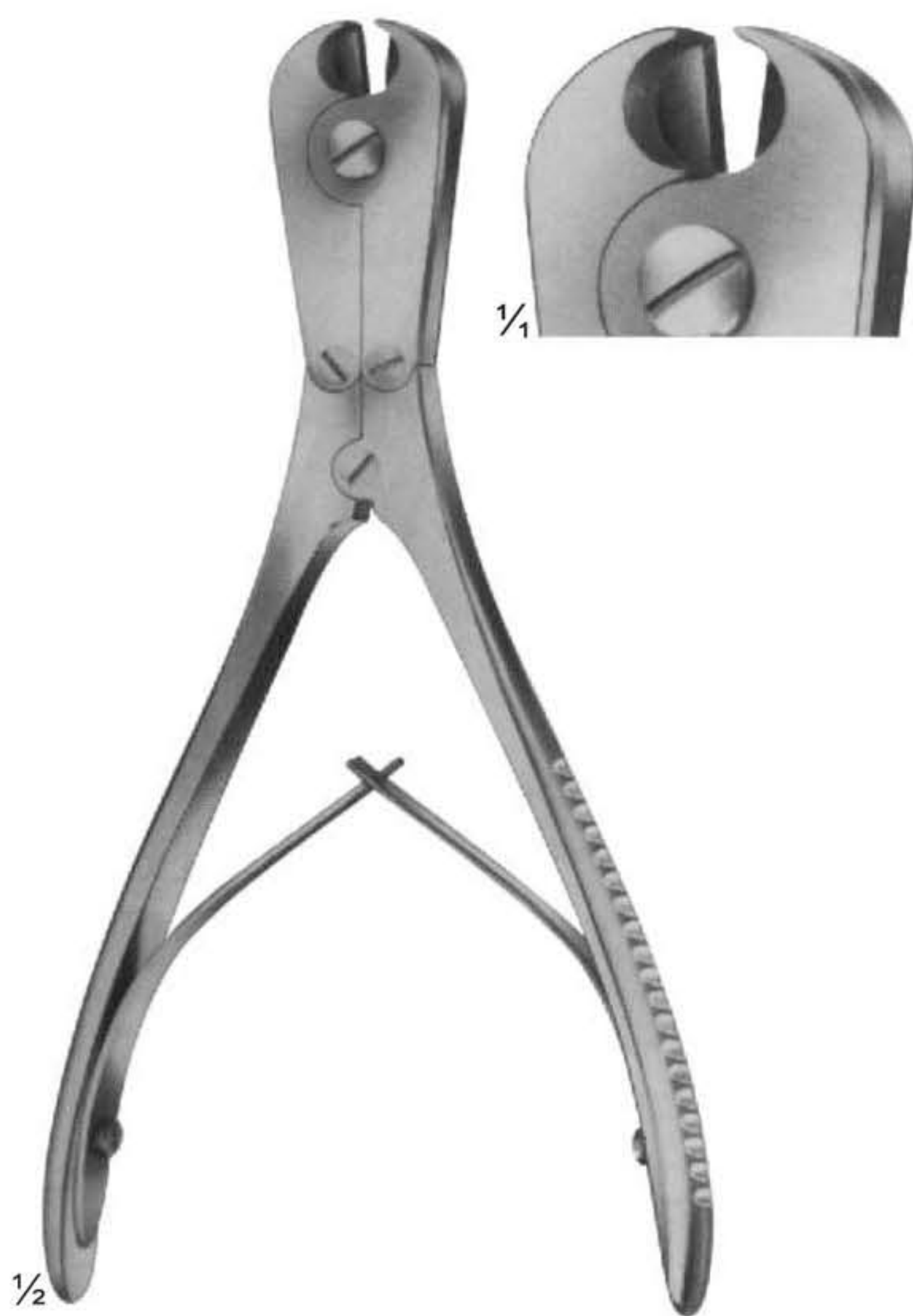

**23-193**  
180 mm

for soft wire  
up to diam. 2,0 mm  
For hard wire 1,5 mm  
up to diam  
specially hardened  
cutting edges, front  
and lateral cutting  
action



**23-194**  
REILL  
175 mm

for soft wire  
up to diam. 2,0 mm  
For hard wire 1,6 mm  
up to diam  
specially hardened  
cutting edges, for  
cutting off wires close  
to the bone



**23-195**  
235 mm

for soft wire  
up to diam. 3,0 mm  
For hard wire 2,2 mm  
up to diam



## Wire Cutting Pliers, Lateral and Front Cutting Action



1/2

**23-196**  
240 mm

for soft wire  
up to diam.  
For hard wire  
up to diam

2,0 mm  
1,6 mm



1/2

**23-197**  
140 mm

for soft wire  
up to diam.  
For hard wire  
up to diam

1,5 mm  
1,0 mm

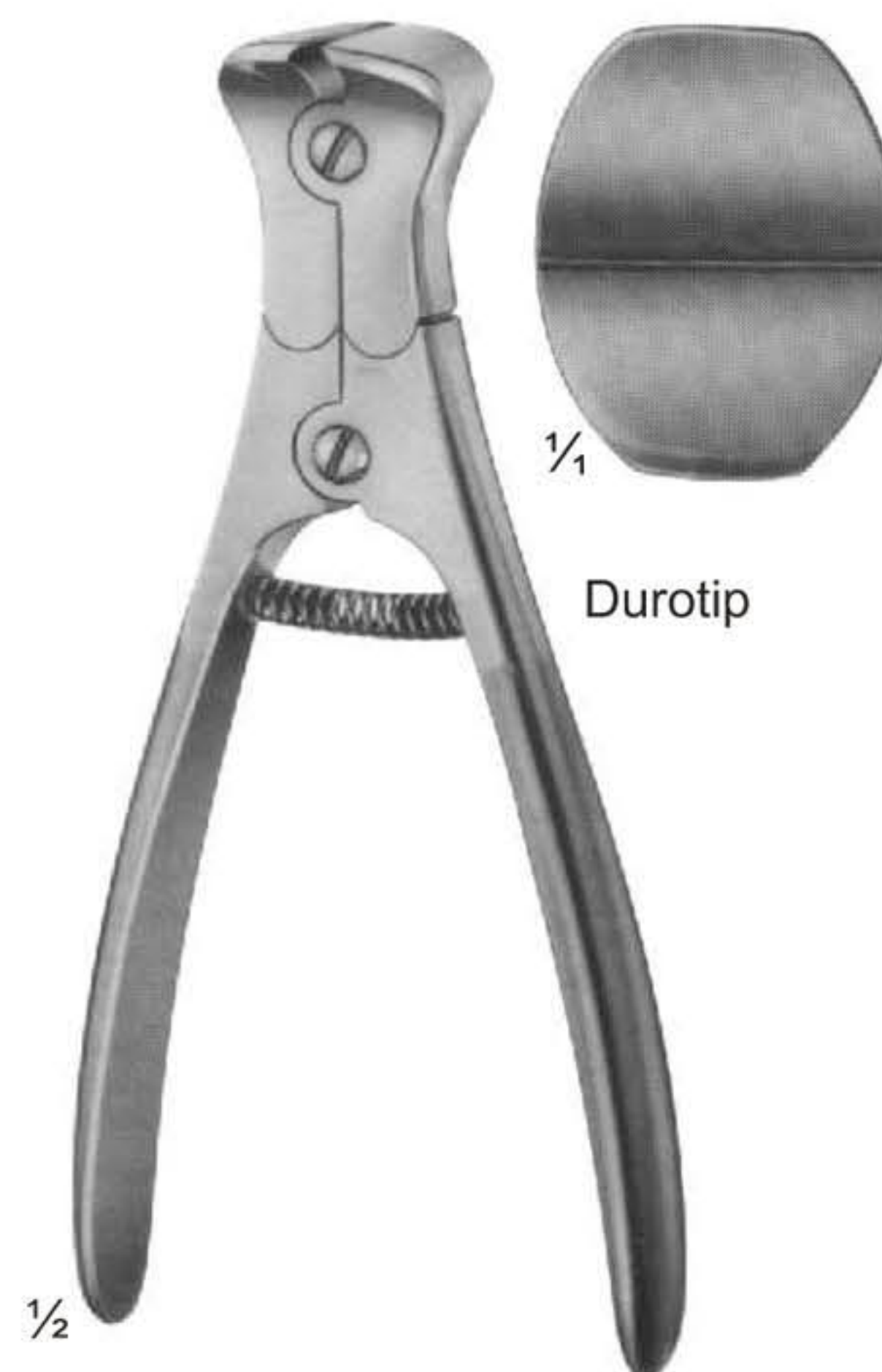

1/2

**23-198**  
145 mm

for soft wire  
up to diam.  
For hard wire  
up to diam

2,0 mm  
1,5 mm

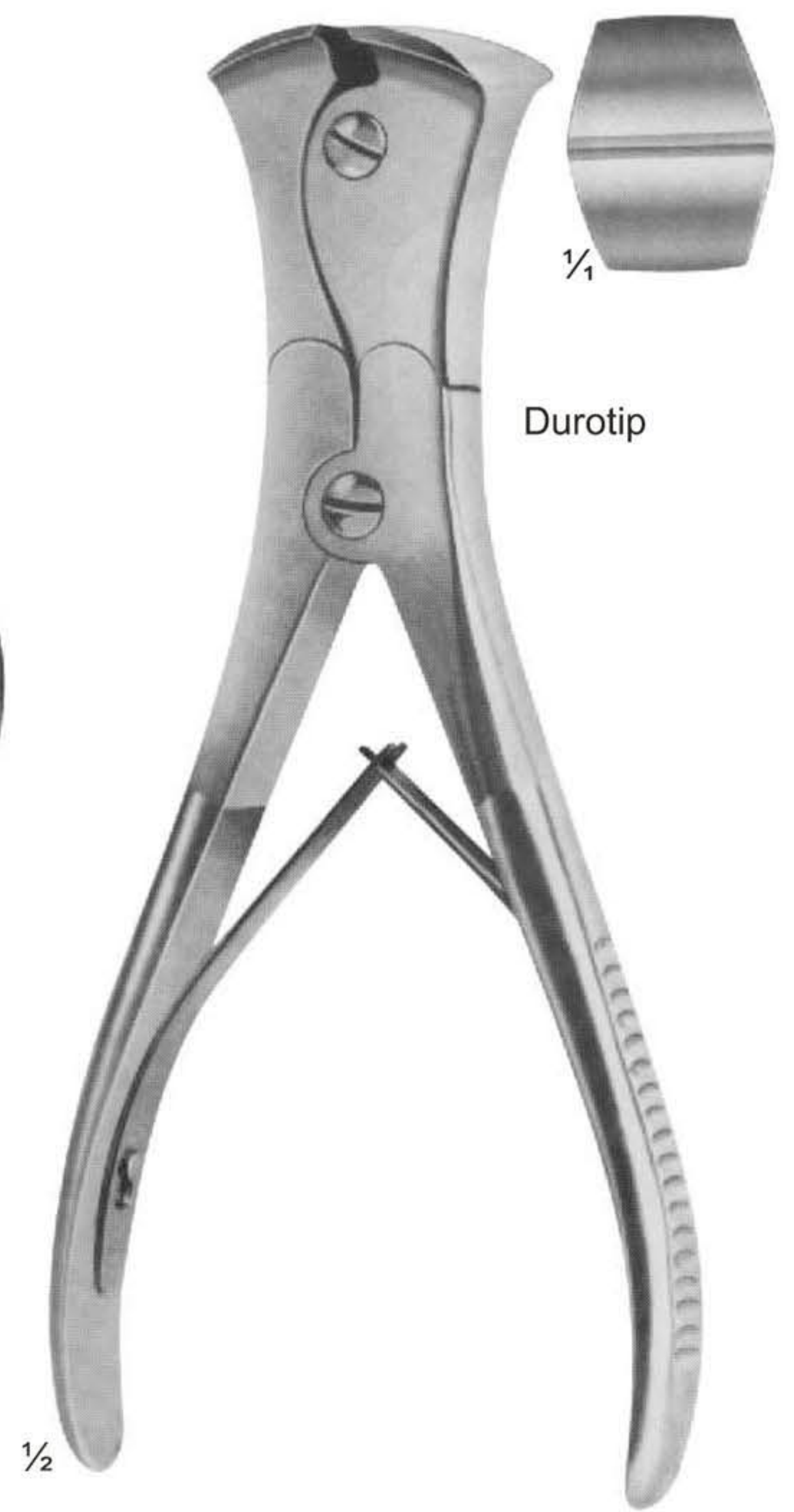

1/2

**23-199**  
220 mm

for soft wire  
up to diam.  
For hard wire  
up to diam

3,5 mm  
2,5 mm



# Wire Cutting Pliers



1/3

Cutter for cutting off  
KIRSCHNER wires,  
Tibia head screws,  
bolts, pins, up to 3 mm diam.

**23-200**  
320 mm

for soft wire up to diam. 3,0 mm  
For hard wire up to diam 3,0 mm



Durotip

**23-201**  
Cutter for cutting off  
KIRSCHNER wires,  
Tibia head screws,  
bolts, pins, up to 6 mm diam.  
470 mm



# Finger Nail Instruments

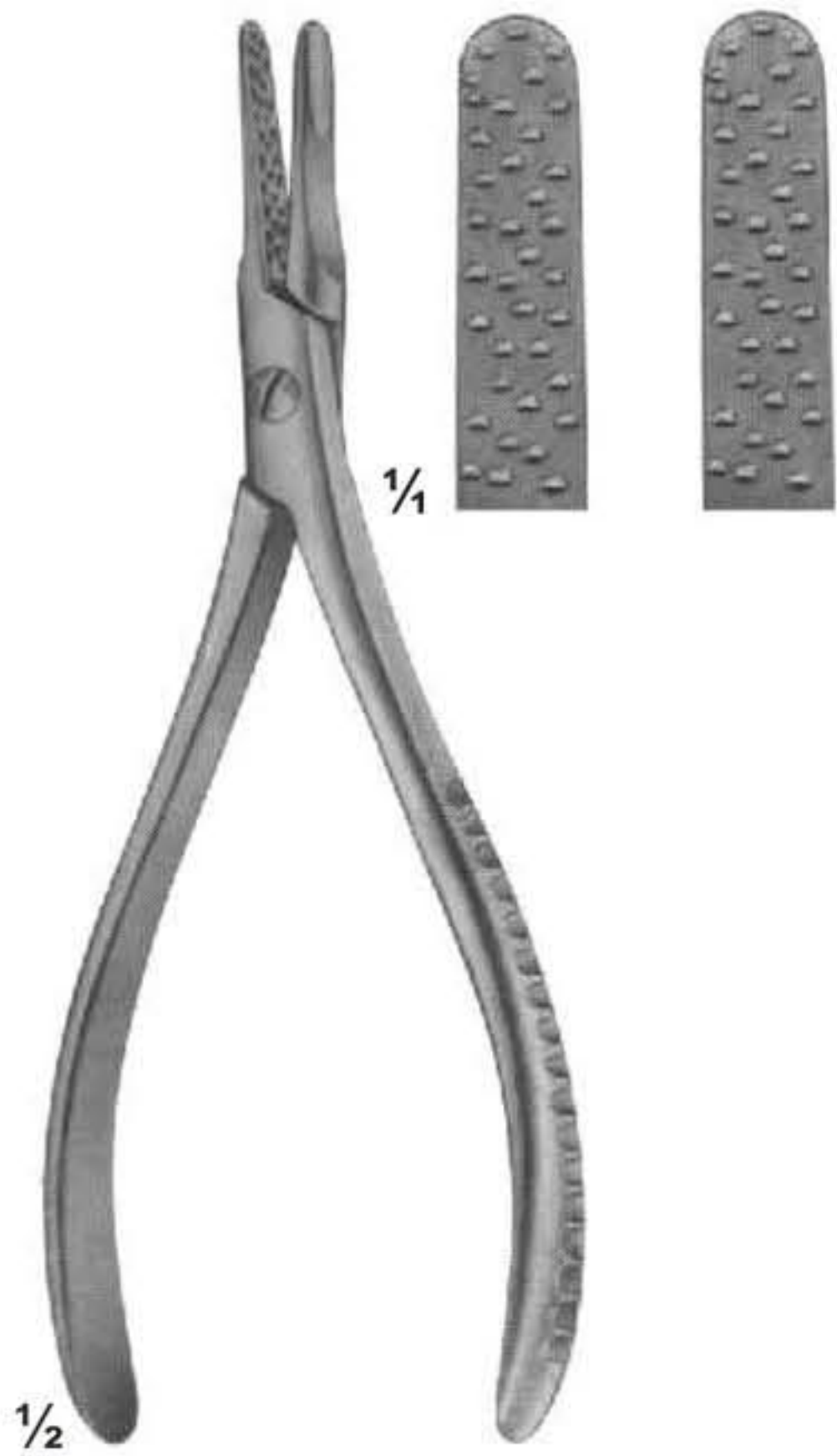

**23-202**  
Nail extracting  
forceps  
135 mm



**23-203**  
Nail extracting  
forceps  
145 mm

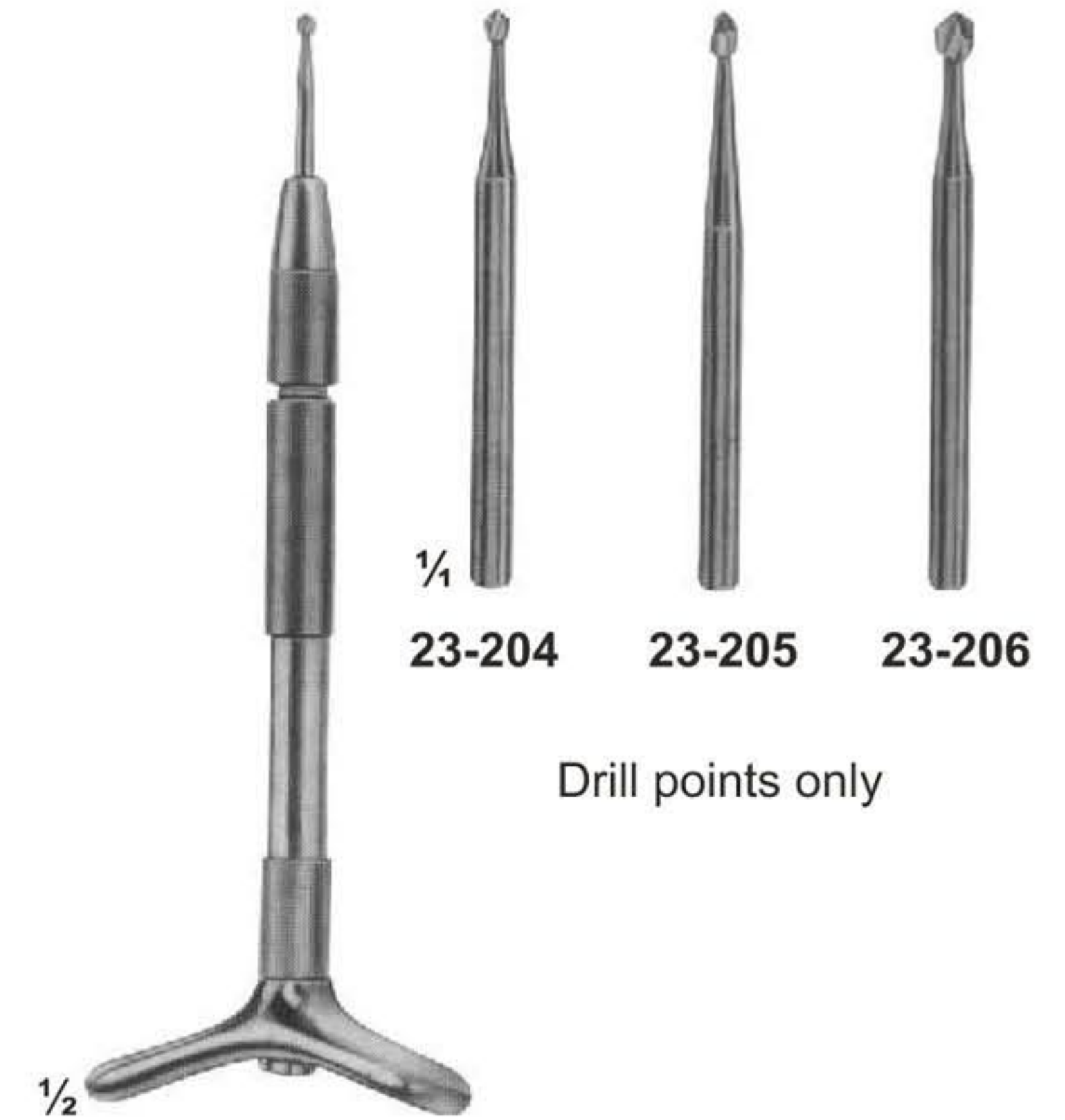

**23-204 - 206**  
Finger nail drill  
with 3 points

Drill points only

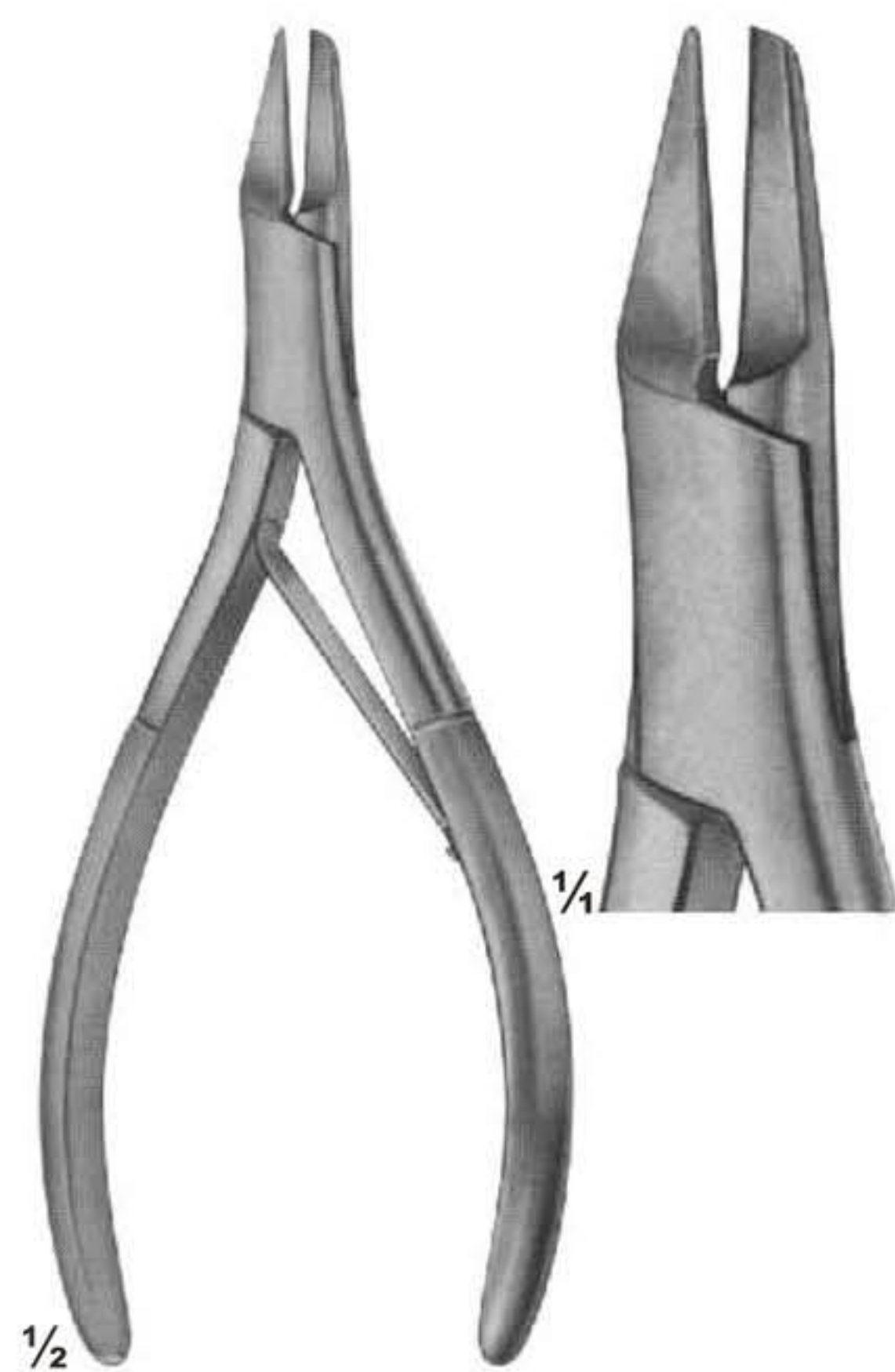

**23-207**  
Nail splitting  
forceps  
135 mm

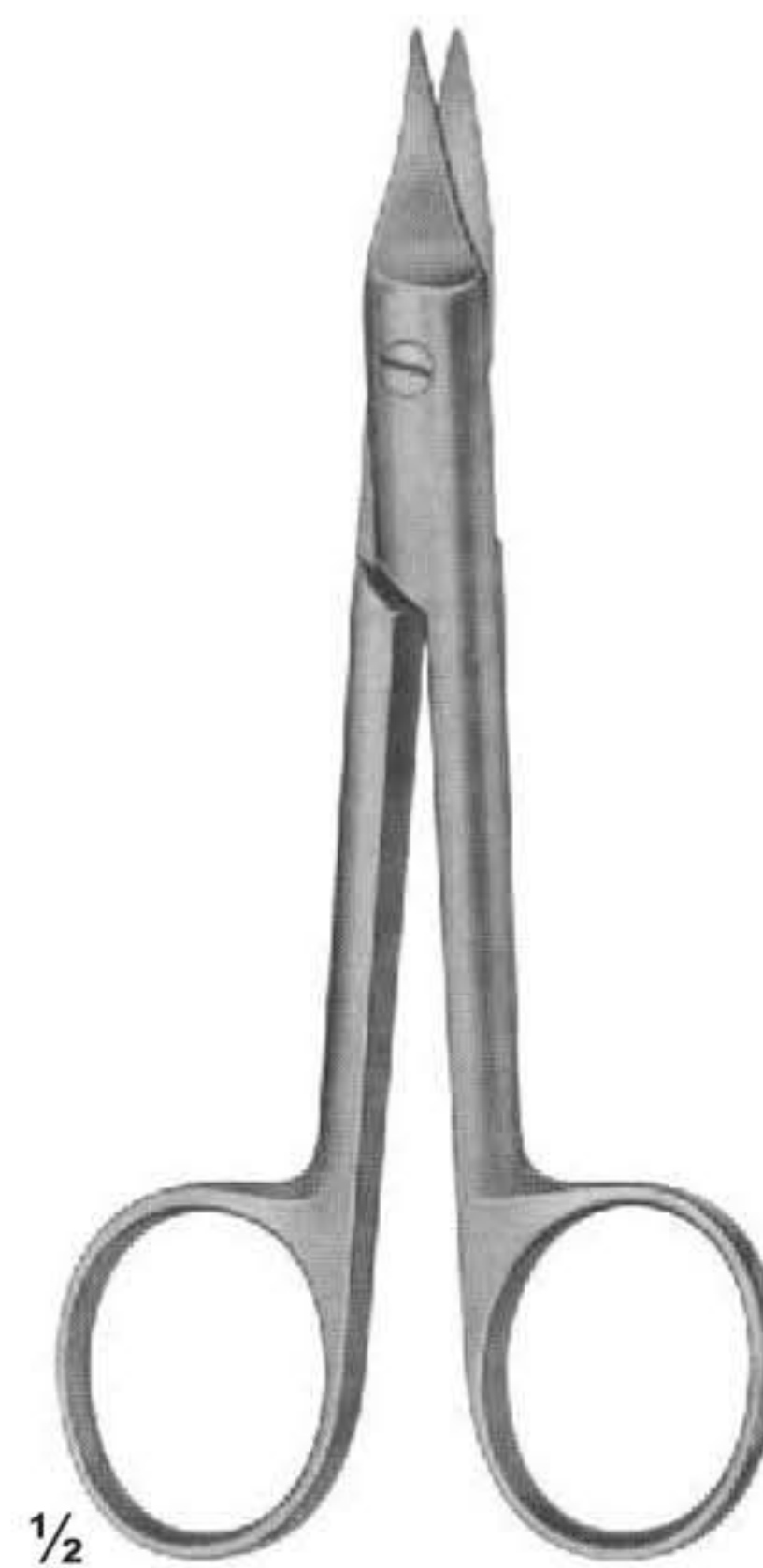

**23-208**  
SYSTRUNK  
Scissors, for splitting  
finger nails  
130 mm



**23-209**  
Finger ring saw  
150 mm

Spare blade



**Plaster Instruments**



with ebony handle

**24-101**  
HOPKINS  
200 mm



**24-102**  
ESMARCH  
180 mm



**24-103**  
ENGEL  
160 mm

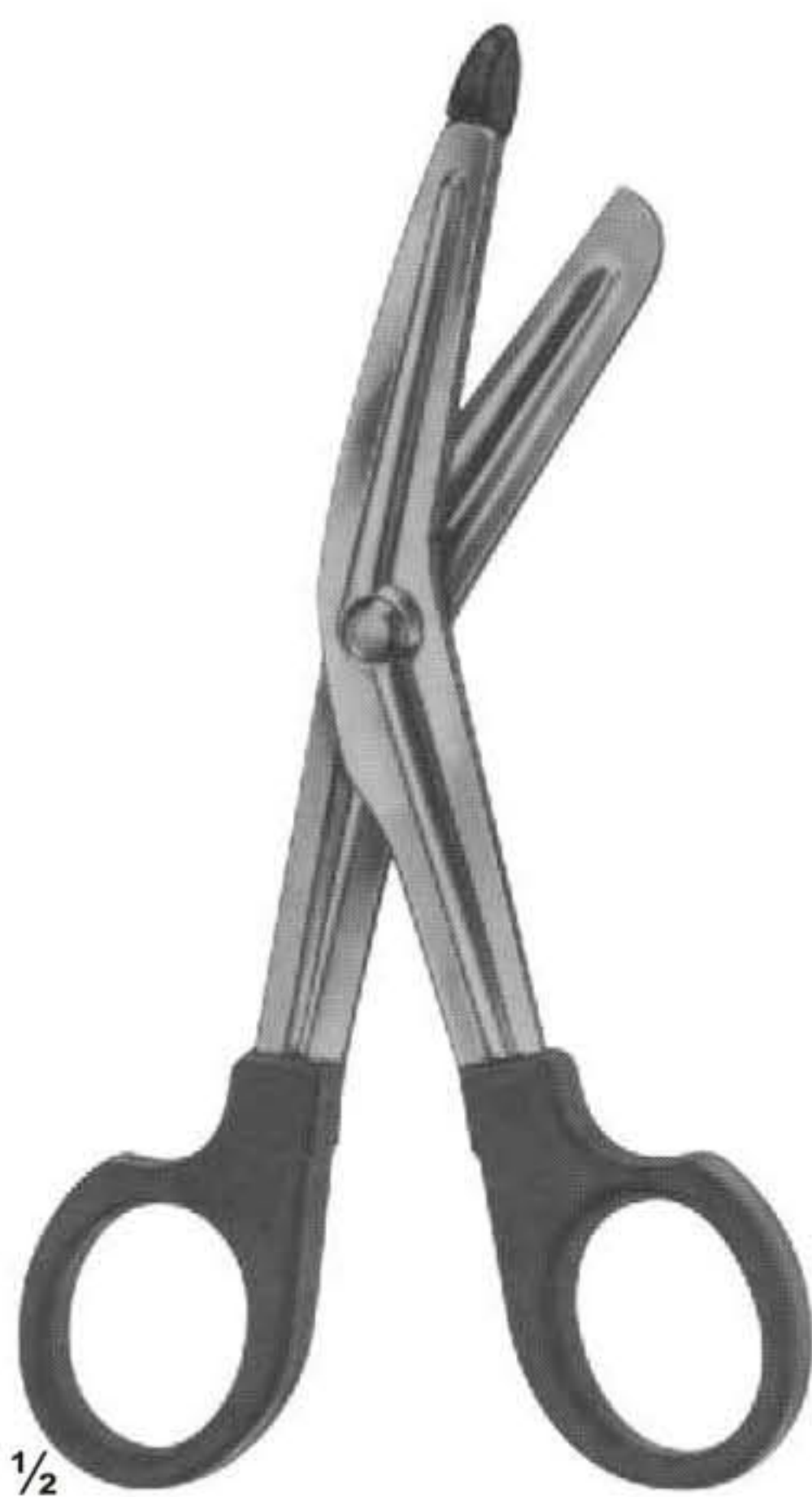

**24-104 - 112**

- |               |       |               |             |
|---------------|-------|---------------|-------------|
| <b>24-104</b> | black | <b>24-108</b> | yellow      |
| <b>24-105</b> | red   | <b>24-109</b> | white       |
| <b>24-106</b> | blue  | <b>24-110</b> | orange      |
| <b>24-107</b> | green | <b>24-111</b> | lavender    |
|               |       | <b>24-112</b> | bright pink |



**24-113 - 121**

- |               |       |               |             |
|---------------|-------|---------------|-------------|
| <b>24-113</b> | black | <b>24-117</b> | yellow      |
| <b>24-114</b> | red   | <b>24-118</b> | white       |
| <b>24-115</b> | blue  | <b>24-119</b> | orange      |
| <b>24-116</b> | green | <b>24-120</b> | lavender    |
|               |       | <b>24-121</b> | bright pink |



**Plaster Scissors**

For small plaster dressings





# Plaster Shears



**24-129**  
STILLE-AESULAP  
260 mm



**24-130**  
STILLE-AESULAP  
360 mm



# STILLE Plaster Shears

Blade with reinforced back



**24-131**  
STILLE  
230 mm

**24-132**  
Spare blade



**24-133**  
STILLE  
370 mm

**24-134**  
Spare blade



**24-135**  
STILLE  
240 mm

**24-136**  
Spare blade



**Plaster Spreader, Plaster Breakers**



**24-137**  
HENING  
270 mm



**24-138**  
MOD.USA  
230 mm



**24-139**  
290 mm



with removable jaws



**24-140 - 141**  
WOLFF  
24-140 180 mm  
24-141 240 mm



## Vacuum Currettes for Aspiration Lipectomy, Suction Instruments

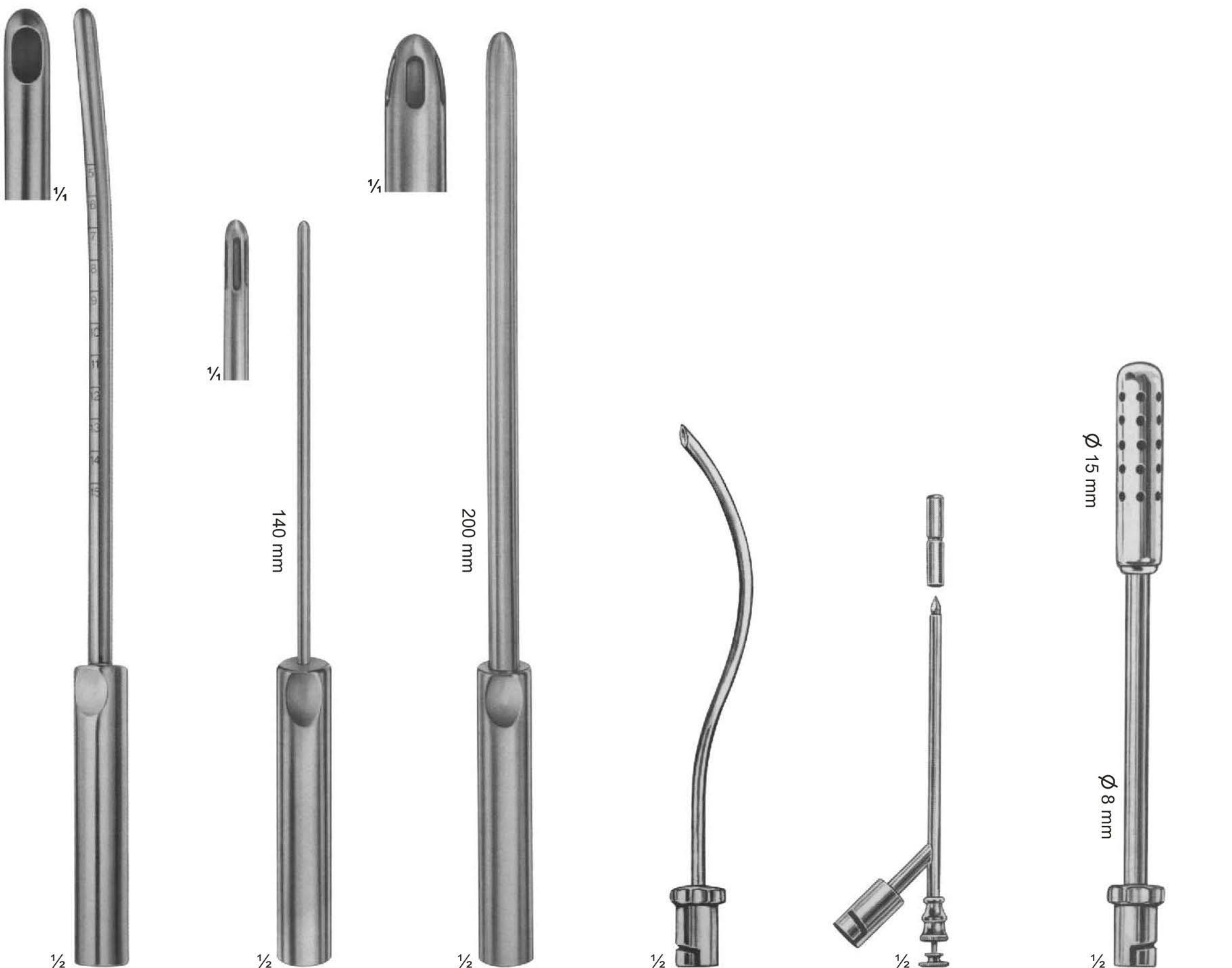

**25-101 - 106**  
BIEMER  
25-101 ø 4 mm  
25-102 ø 6 mm  
25-103 ø 8 mm  
25-104 ø 10 mm  
25-105 ø 12 mm  
25-106 ø 14 mm  
Currettes for aspiration lipectomy, graduated, slightly curved

**25-107 - 108**  
BIEMER  
25-107 ø 4 mm  
25-108 ø 6 mm  
Currettes for aspiration lipectomy, with three apertures, slightly curved malleable

**25-109 - 111**  
BIEMER  
25-109 ø 8 mm  
25-110 ø 10 mm  
25-111 ø 12 mm  
Currettes for aspiration lipectomy, with three apertures, slightly curved malleable

**25-112**  
For aspirating fluid from the excretory ducts of large glands and for keeping the operating area clear  
170 mm

**25-113**  
Trocar  
For puncturing  
150 mm

**25-114**  
For clearing large quantities of fluid  
190 mm



# Suction Instruments



**25-115**  
Trocar  
For puncturing  
170 mm



**25-116**  
Hollow needle,  
sharp  
150 mm



**25-117**  
double curved  
For general  
surgery  
230 mm



**25-118**  
For tonsillectomy,  
oral and laryngeal  
operations  
190 mm



**25-119**  
For tonsillectomy,  
oral and laryngeal  
operations  
220 mm



**Suction Instruments**

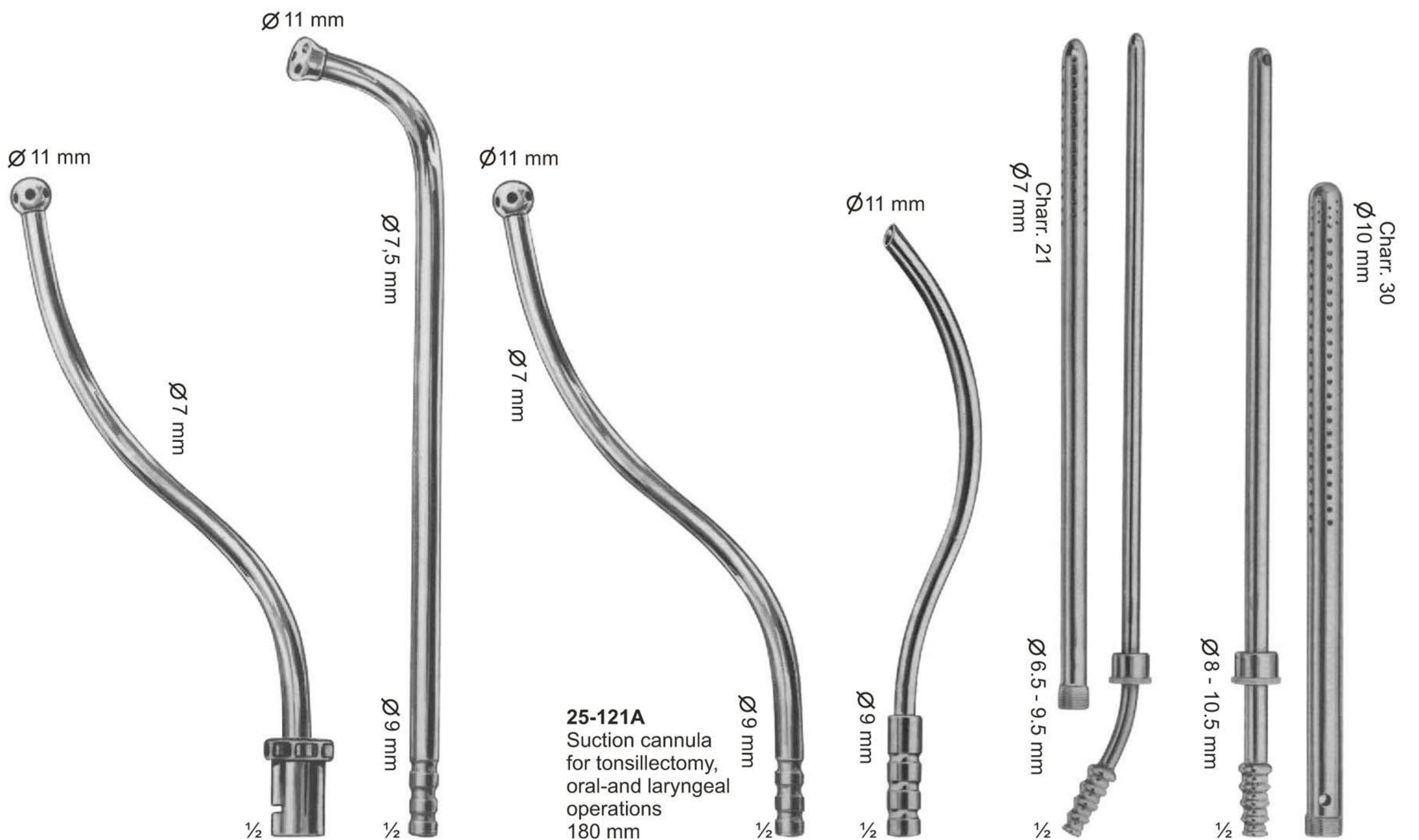

**25-120**  
For tonsillectomy,  
oral-and laryngeal  
operations  
180 mm

**25-121**  
Suction cannula  
for tonsillectomy,  
oral-and laryngeal  
operations  
220 mm

**25-121A**  
Suction cannula  
for tonsillectomy,  
oral-and laryngeal  
operations  
180 mm

**25-122**  
S-shaped blunt cannula  
for aspirating fluid from  
the excretory ducts of  
large glands and for  
keeping the operations  
area clear  
170 mm

**25-123**  
POOL  
Suction cannula,  
with outer tube  
to be screwed of  
225 mm

**25-124**  
POOL  
Suction cannula,  
with outer tube  
to be screwed of  
225 mm





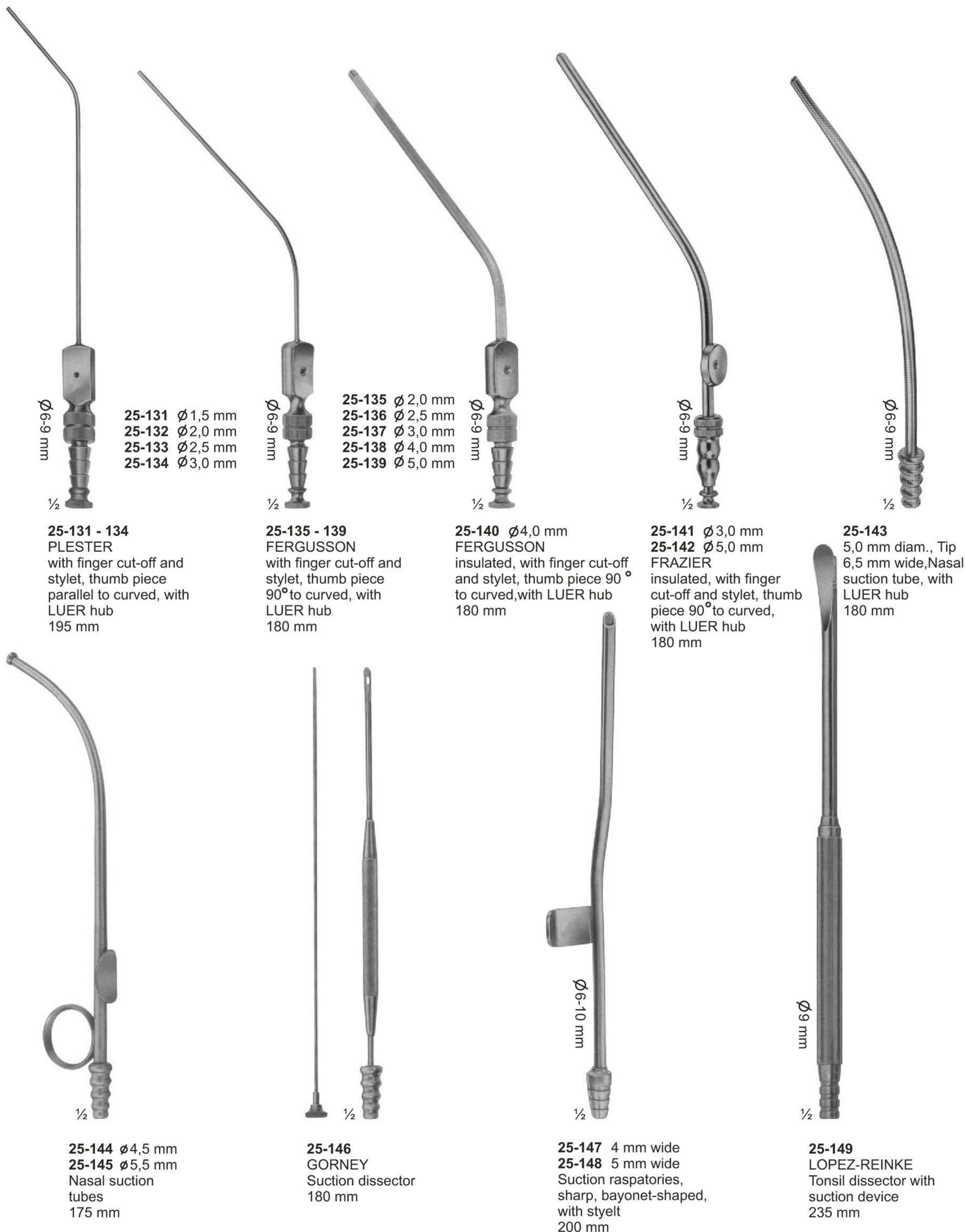

**Suction Instruments**



# Suction Instruments

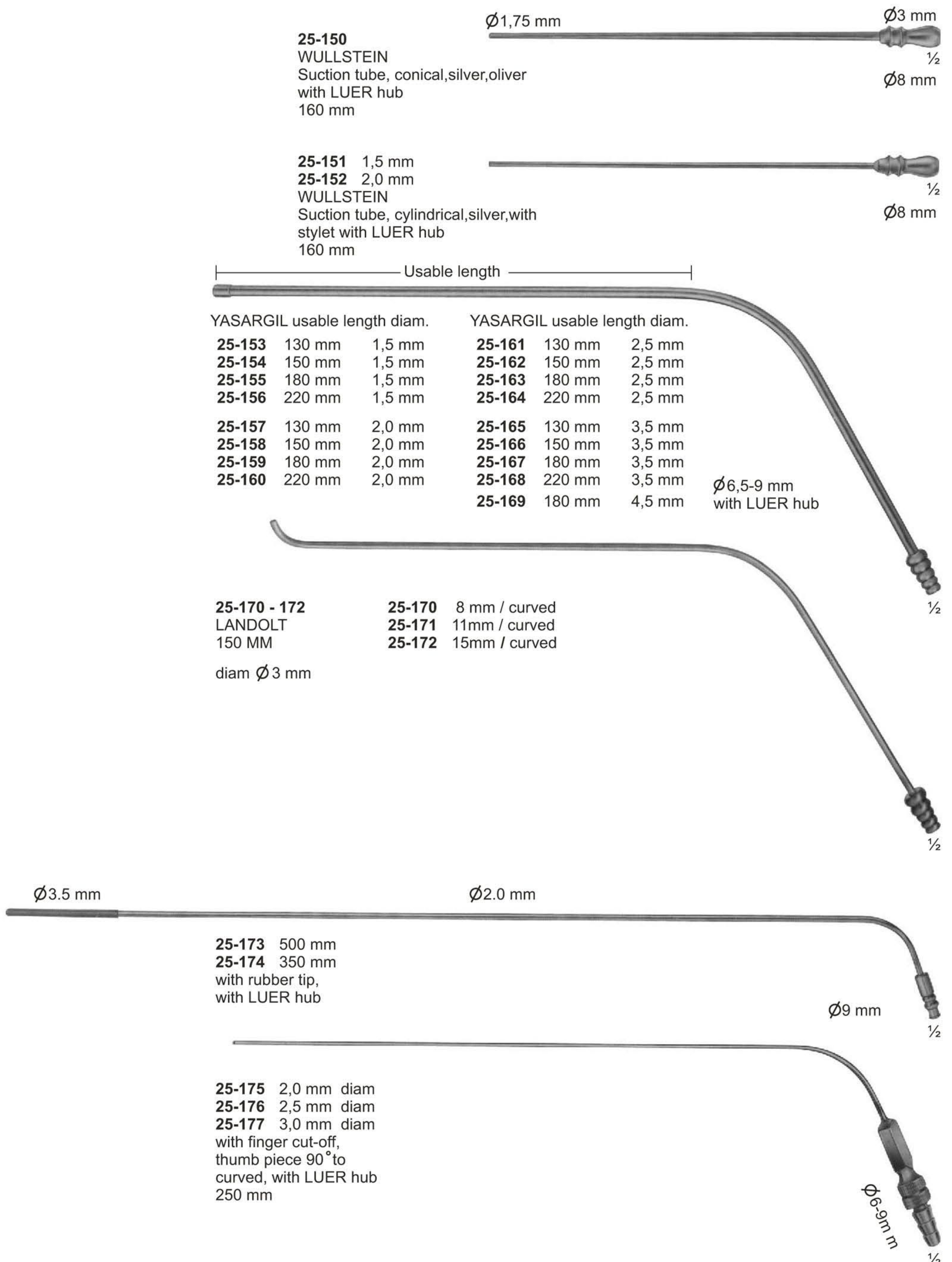

**25-150**  
**WULLSTEIN**  
 Suction tube, conical, silver, oliver  
 with LUER hub  
 160 mm

Ø1,75 mm

Ø3 mm  
 1/2  
 Ø8 mm

**25-151** 1,5 mm  
**25-152** 2,0 mm  
**WULLSTEIN**  
 Suction tube, cylindrical, silver, with  
 stylet with LUER hub  
 160 mm

Ø8 mm  
 1/2

Usable length

YASARGIL usable length diam.		YASARGIL usable length diam.	
<b>25-153</b>	130 mm 1,5 mm	<b>25-161</b>	130 mm 2,5 mm
<b>25-154</b>	150 mm 1,5 mm	<b>25-162</b>	150 mm 2,5 mm
<b>25-155</b>	180 mm 1,5 mm	<b>25-163</b>	180 mm 2,5 mm
<b>25-156</b>	220 mm 1,5 mm	<b>25-164</b>	220 mm 2,5 mm
<b>25-157</b>	130 mm 2,0 mm	<b>25-165</b>	130 mm 3,5 mm
<b>25-158</b>	150 mm 2,0 mm	<b>25-166</b>	150 mm 3,5 mm
<b>25-159</b>	180 mm 2,0 mm	<b>25-167</b>	180 mm 3,5 mm
<b>25-160</b>	220 mm 2,0 mm	<b>25-168</b>	220 mm 3,5 mm
		<b>25-169</b>	180 mm 4,5 mm

Ø6,5-9 mm  
 with LUER hub

**25-170 - 172**  
**LANDOLT**  
 150 MM  
 diam Ø3 mm

**25-170** 8 mm / curved  
**25-171** 11mm / curved  
**25-172** 15mm / curved

Ø3.5 mm

Ø2.0 mm

**25-173** 500 mm  
**25-174** 350 mm  
 with rubber tip,  
 with LUER hub

Ø9 mm  
 1/2

**25-175** 2,0 mm diam  
**25-176** 2,5 mm diam  
**25-177** 3,0 mm diam  
 with finger cut-off,  
 thumb piece 90° to  
 curved, with LUER hub  
 250 mm

Ø6-9mm  
 1/2



# Combined Suction and Irrigation Cannulae

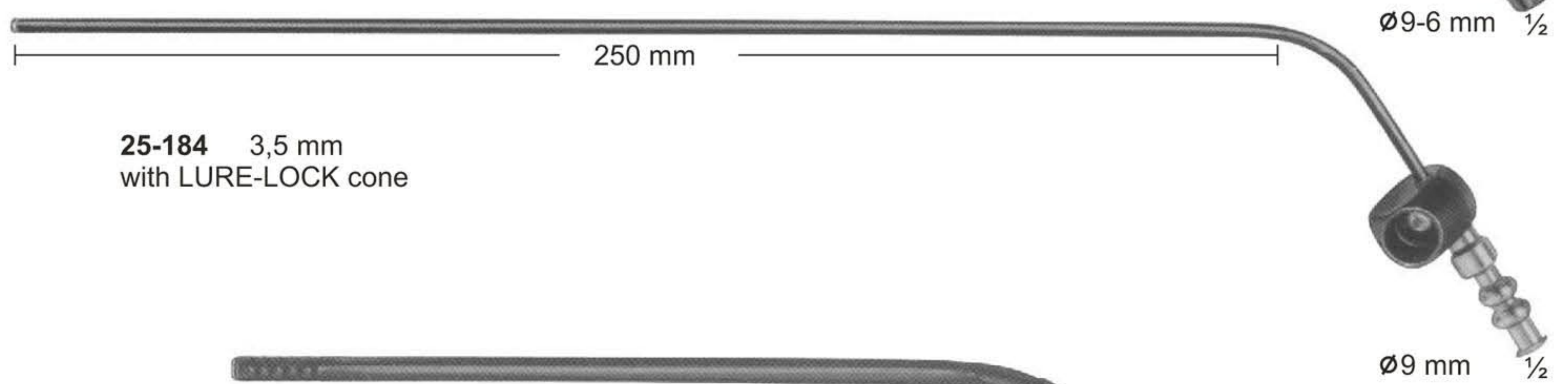
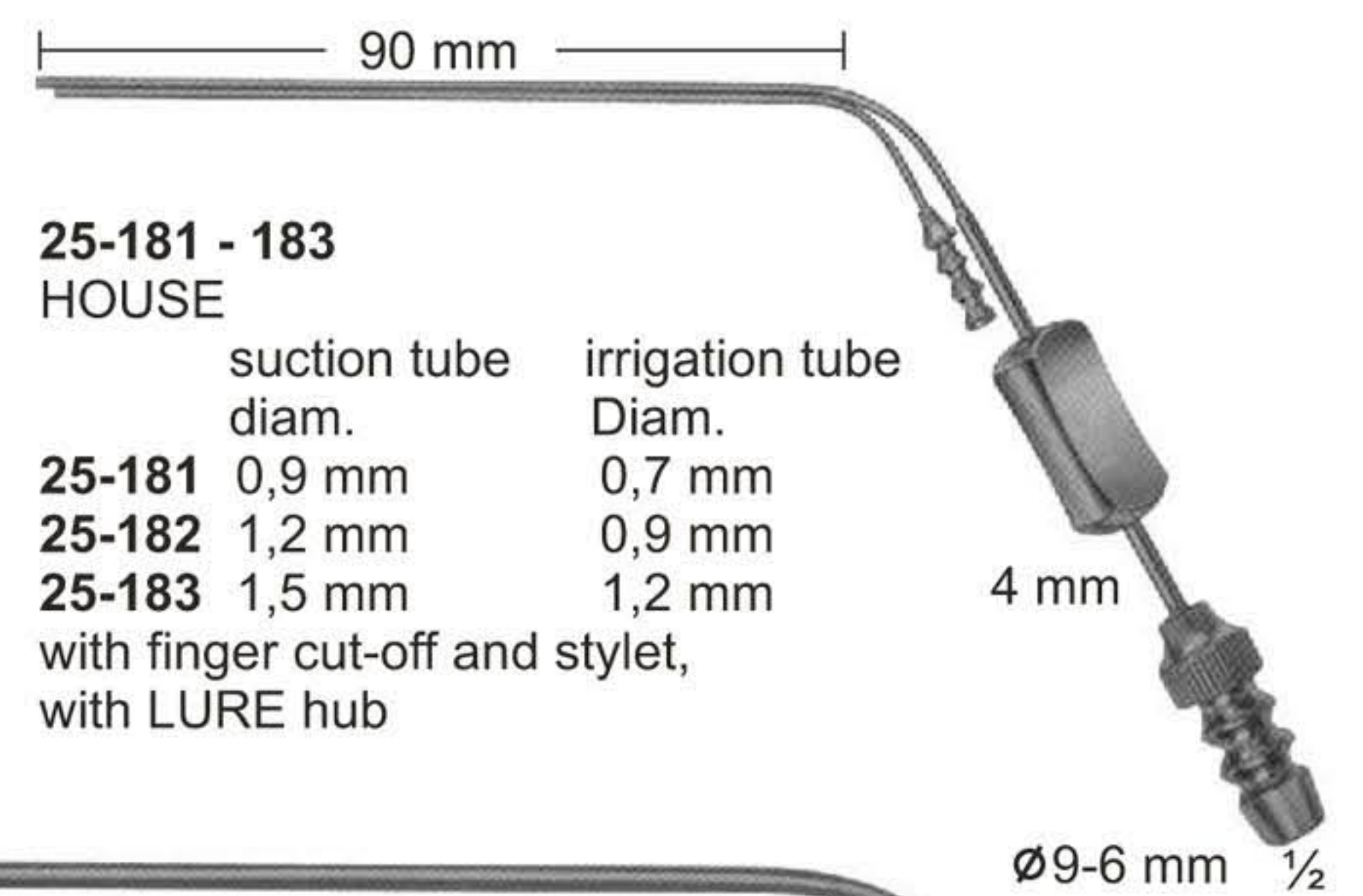
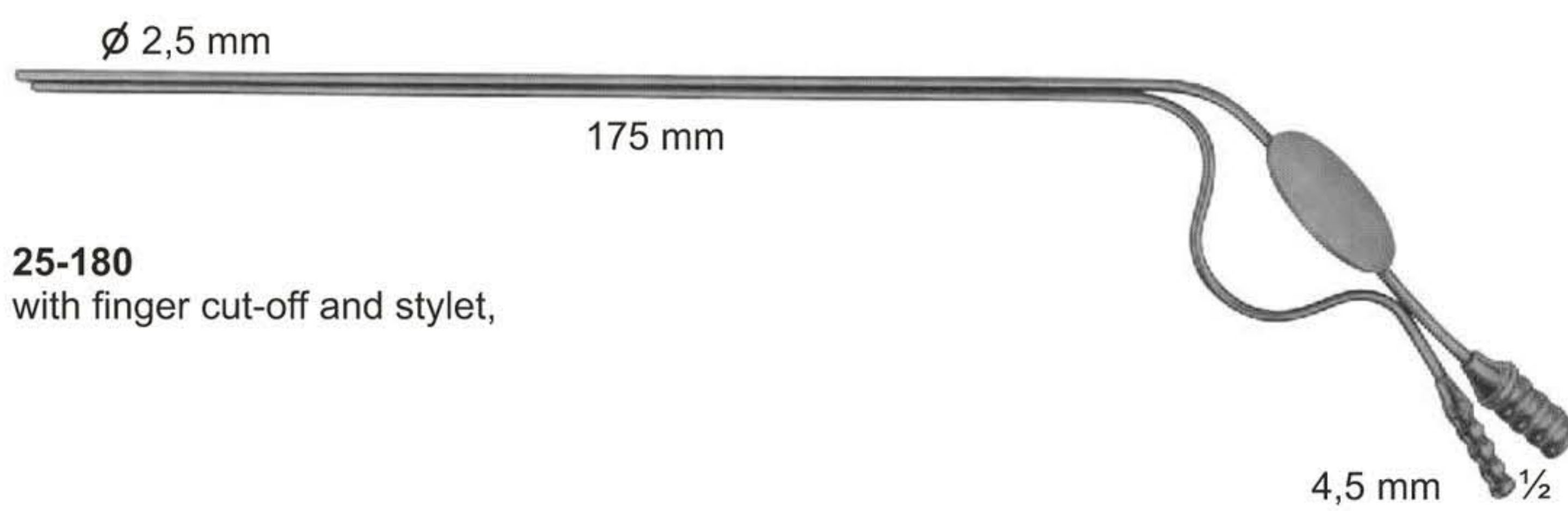



## Scissors with Tungsten Carbide Inserts



**26-101**  
Standard

14,5cm  
16,5cm  
18,5cm



**26-102**  
Standard

14,5cm  
16,5cm  
18,5cm



**26-103**  
Standard

14,5cm  
16,5cm  
18,5cm



**26-104**  
Standard

14,5cm  
16,5cm  
18,5cm



**26-105**  
Standard

14,5cm  
16,5cm  
18,5cm



**26-106**  
Standard

14,5cm  
16,5cm  
18,5cm



Scissors with Tungsten Carbide Inserts

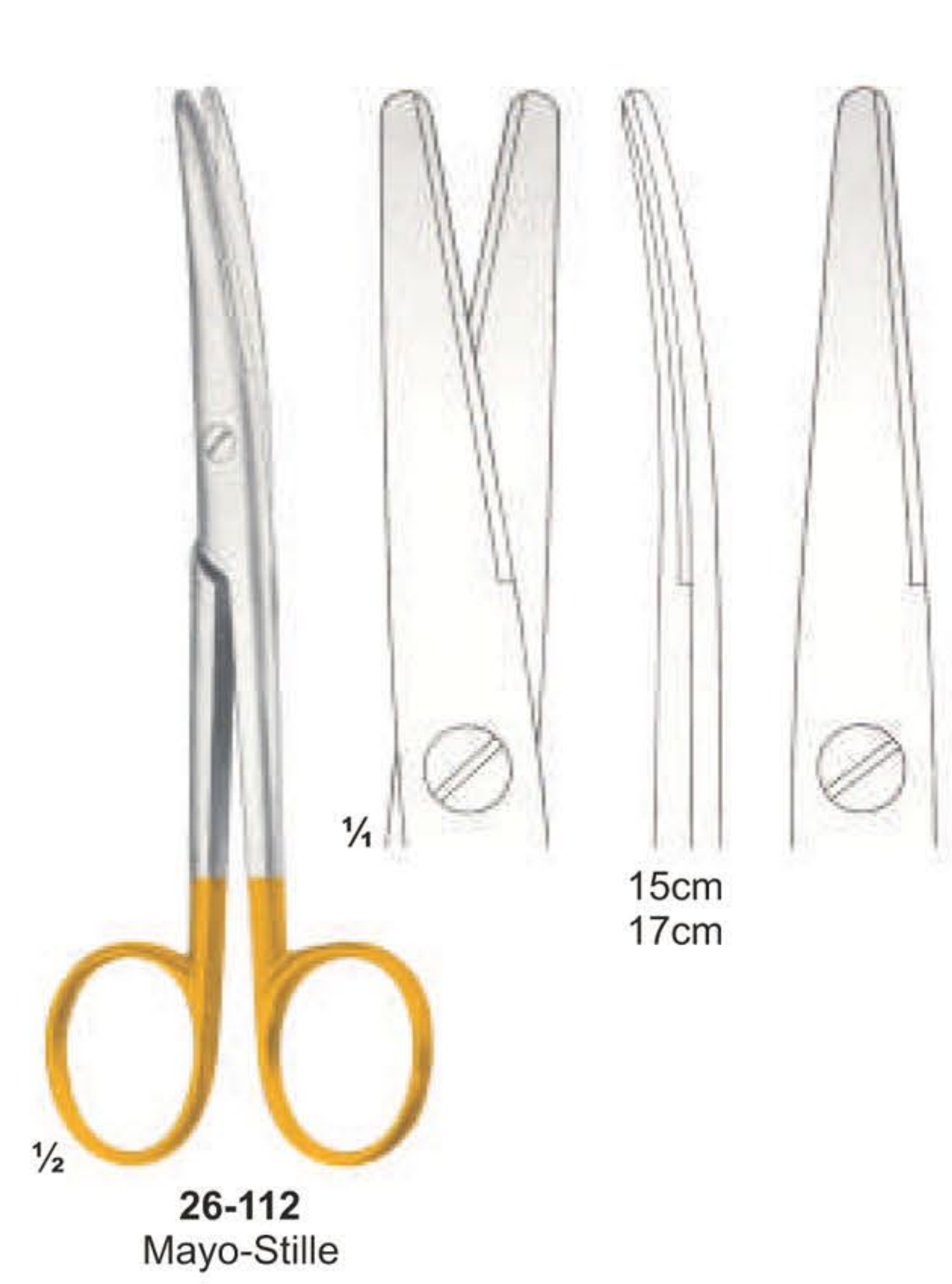



**Scissors with Tungsten Carbide Inserts**





Scissors with Tungsten Carbide Inserts

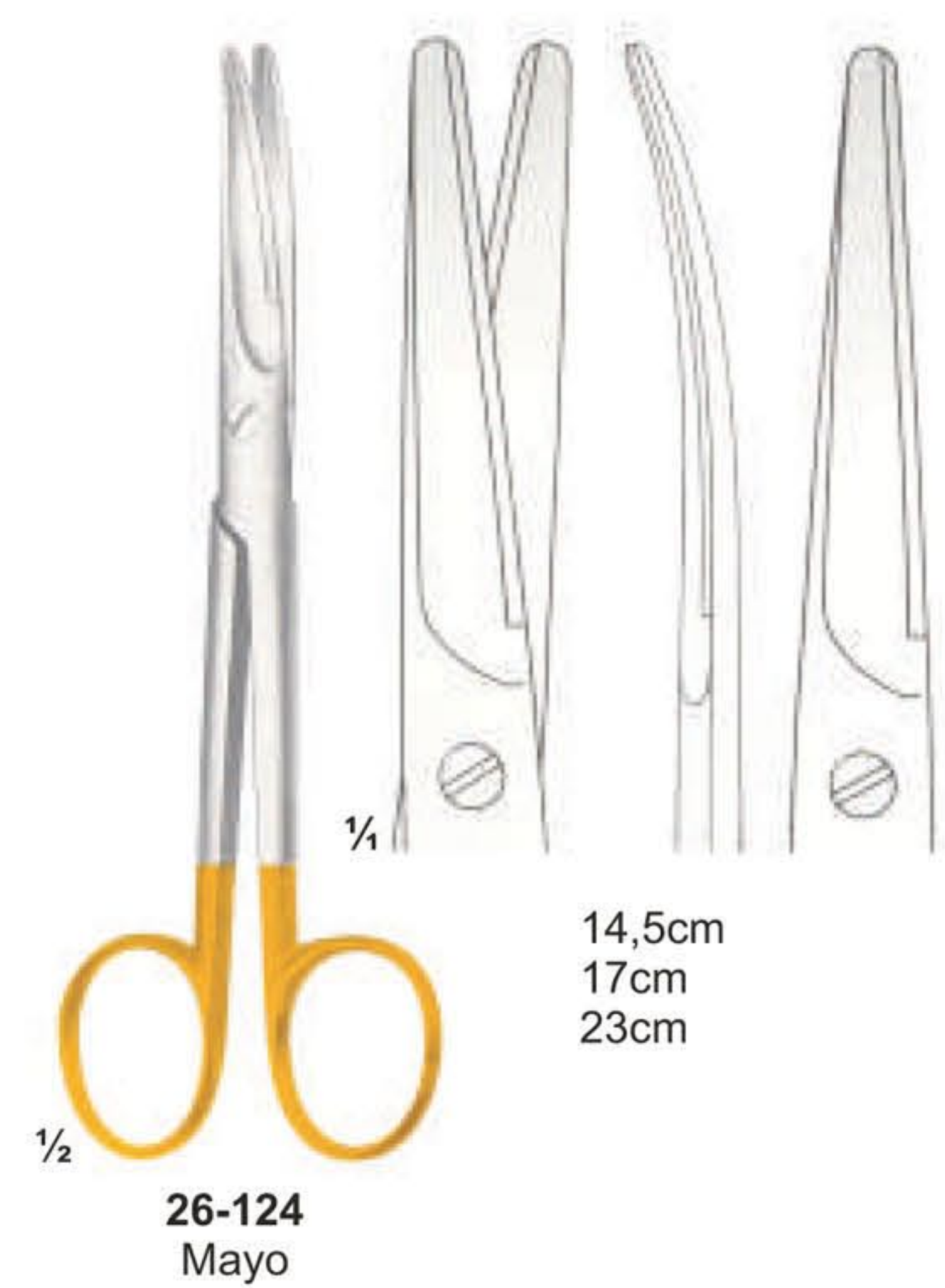



Scissors with Tungsten Carbide Inserts





## Scissors with Tungsten Carbide Inserts





# Scissors & Dissecting Forceps with Tungsten Carbide Inserts

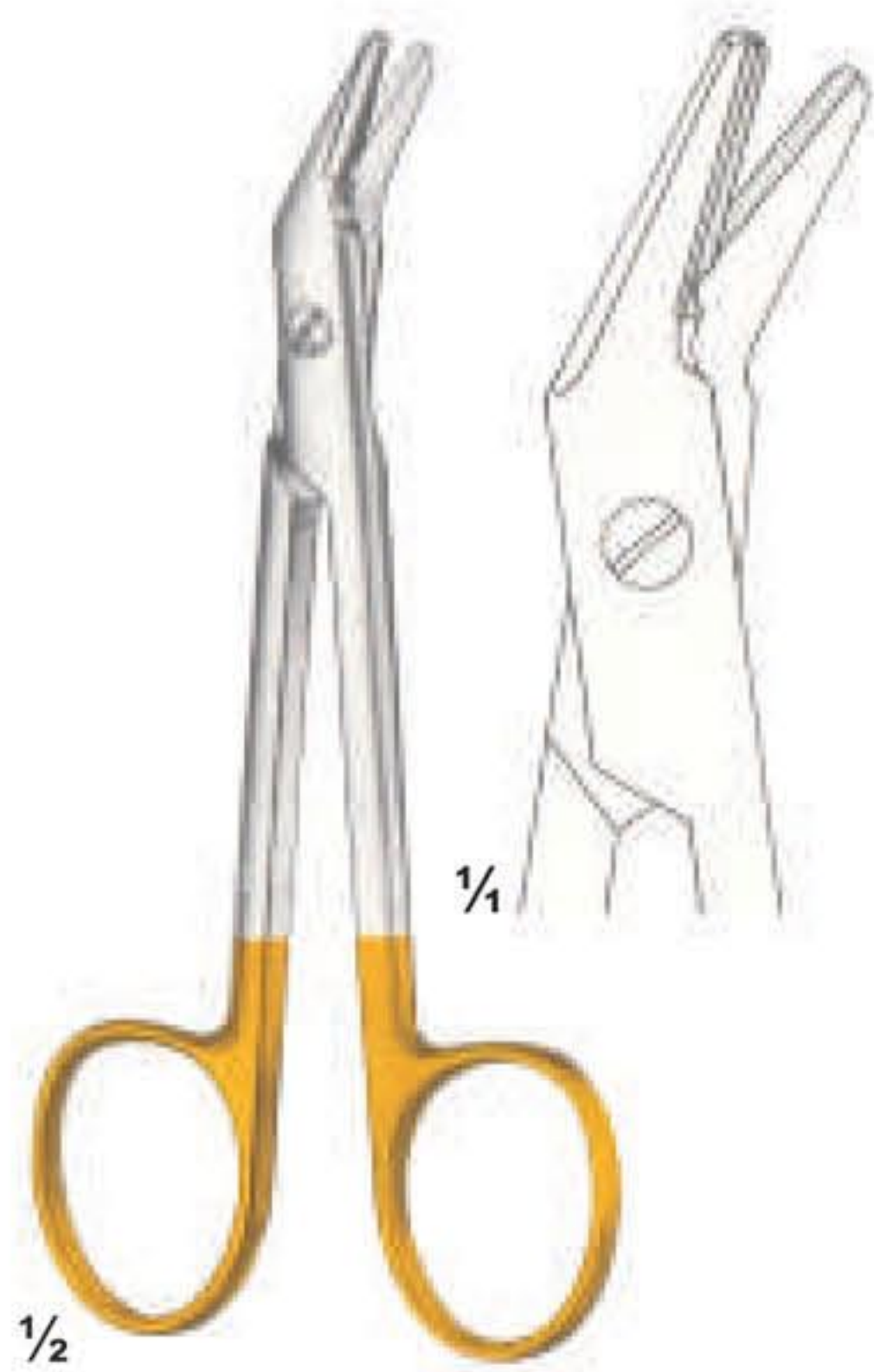

**26-136**  
Universal  
12cm



**26-137**  
Ligature Scissors  
1 Black & 1 Goldplated ring



**26-138**  
Adson



**26-139**  
Cushing  
17,5cm



**26-140**  
Cushing  
18cm



**26-141**  
Cushing-Taylor  
18cm



**26-142**  
Dissecting Forceps  
15cm



**26-143**  
Semken  
15cm



Dissecting Forceps and Needle holders with Tungsten Carbide Inserts



**26-144**  
Wangensteen

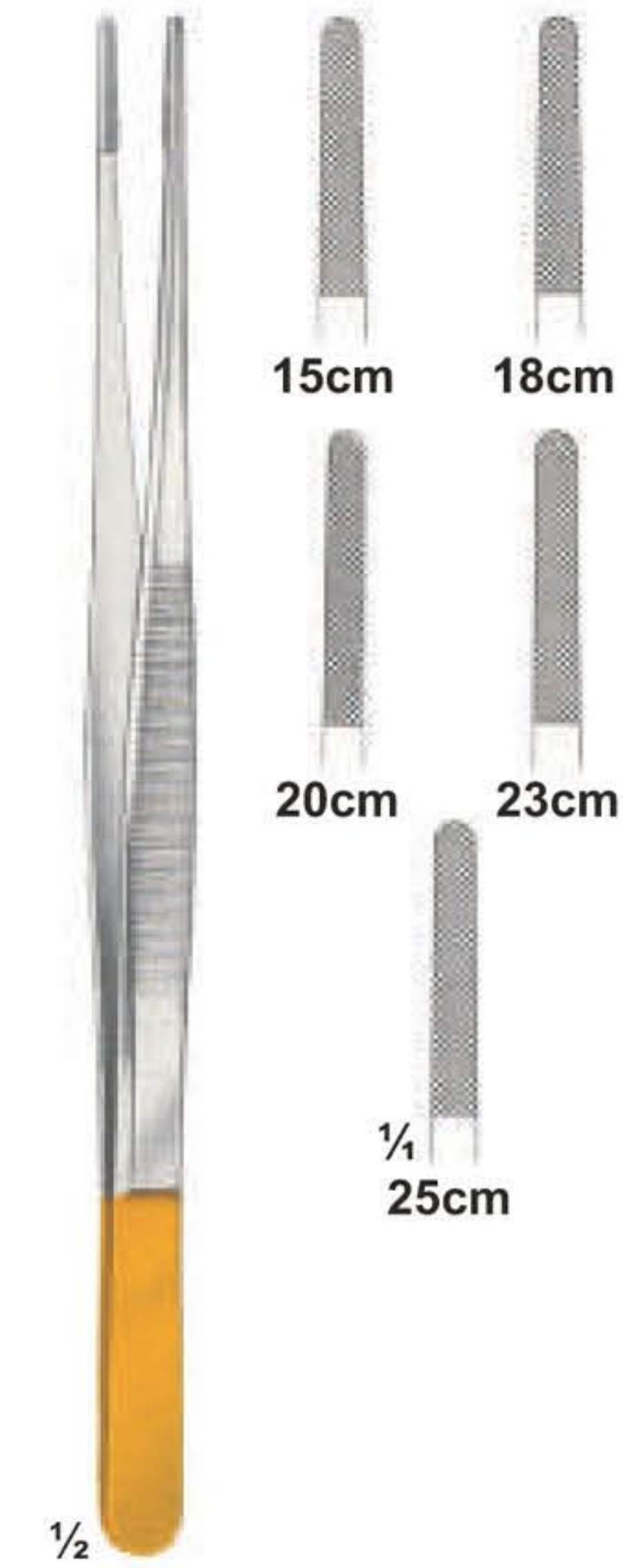

**26-145**  
Potts-Smith

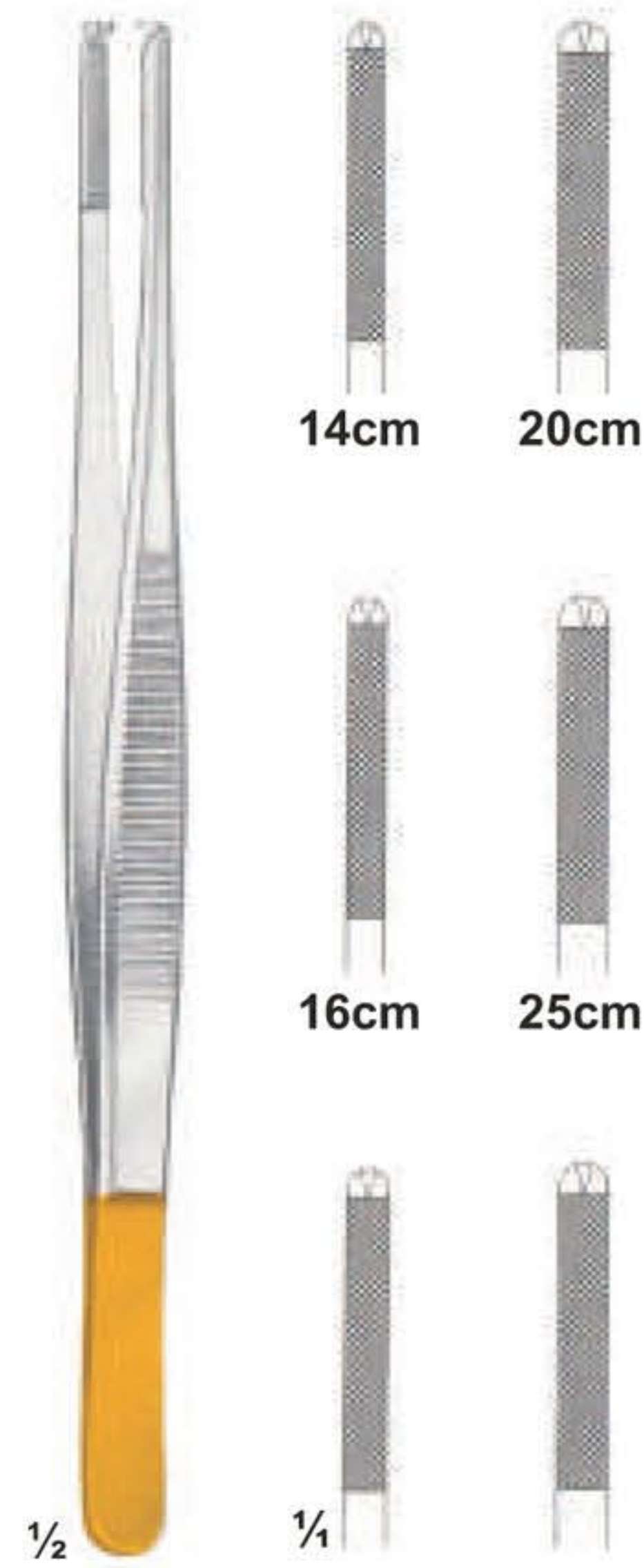

**26-146**  
Oehler



**26-147**  
Potts-Smith  
22cm



**26-148**  
Hepp-Scheidle  
18cm



**26-149**  
Castroviejo  
14cm



**26-150**  
Castroviejo  
14cm



**26-151**  
Arruga  
16cm



## Needle holders with Tungsten Carbide Inserts

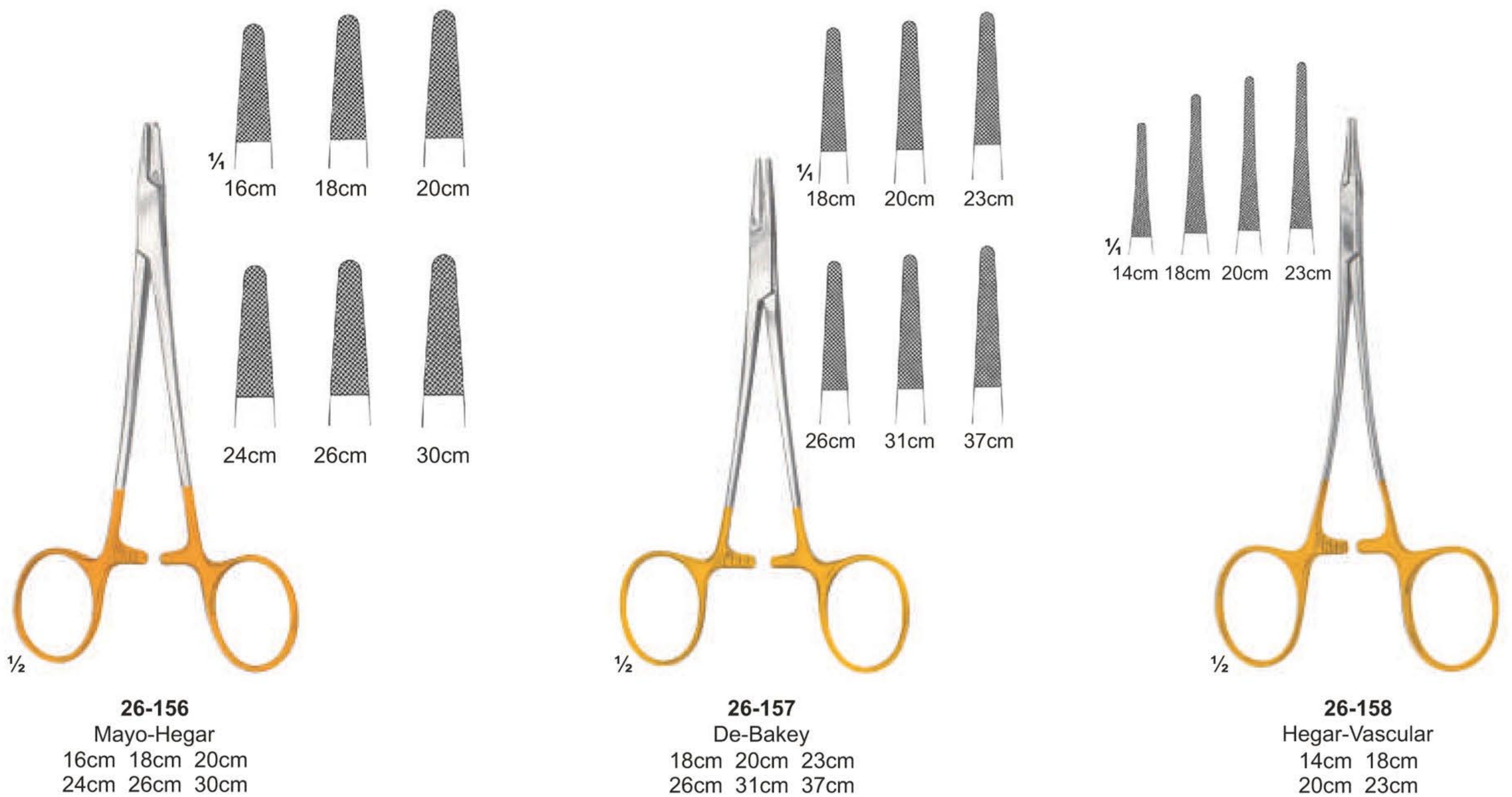
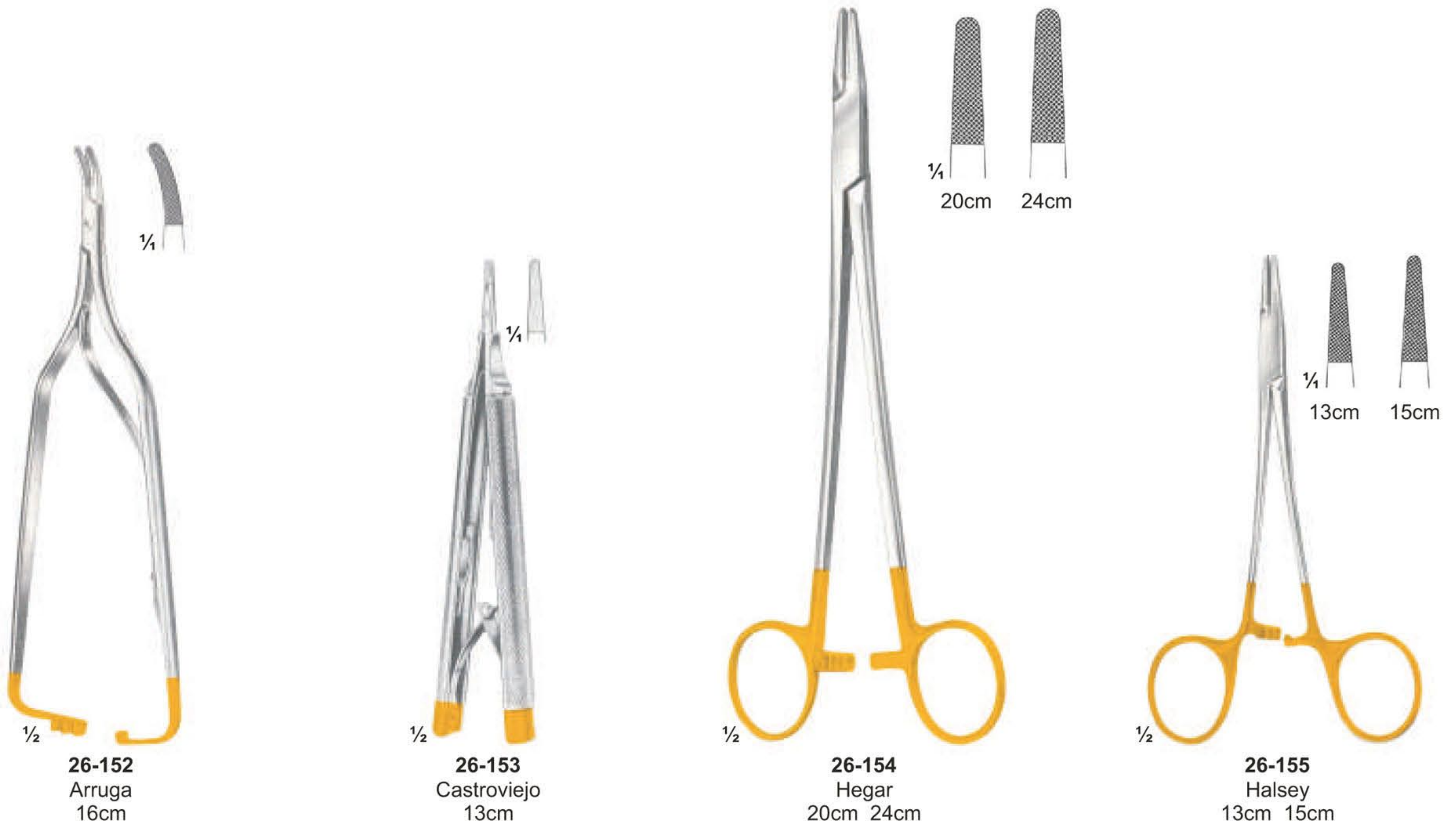



**Needle holders with Tungsten Carbide Inserts**



**26-159**  
Bozemmann-Wertheim  
20cm 24cm 26cm



**26-160**  
Stratte  
22cm 23cm

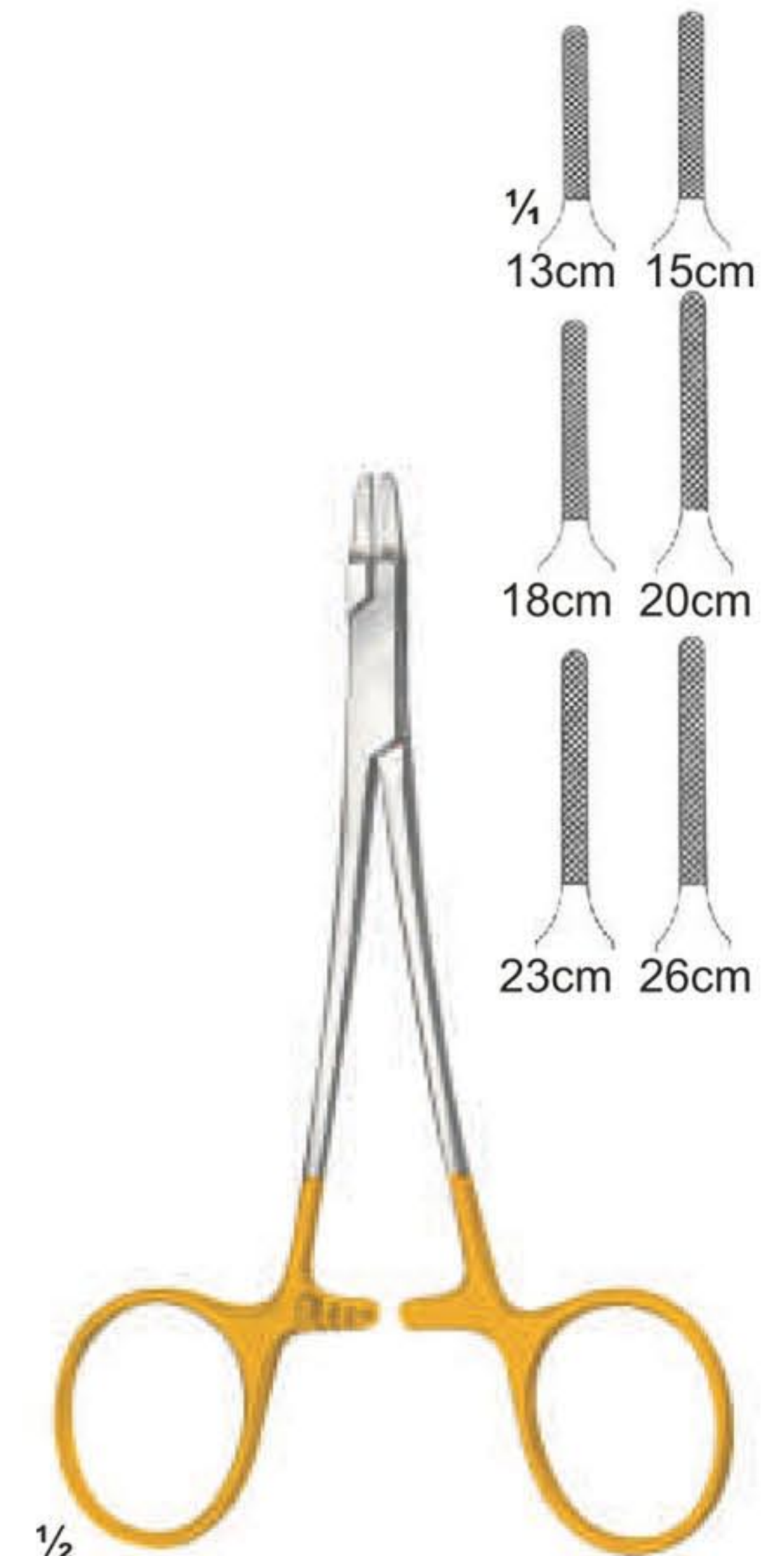

**26-161**  
Ryder  
13cm 15cm 18cm  
20cm 23cm 26cm



**26-162**  
Ryder-Vascular  
13cm 15cm 18cm  
20cm 23cm 26cm



**26-163**  
Martin  
15cm 17cm 20cm



**26-164**  
Sarot  
18cm 20cm 26cm



**Needle holders with Tungsten Carbide Inserts**





## Needle holders with Tungsten Carbide Inserts



1/2  
**26-172**  
Mathieu-Ryder  
17cm  
20cm 24cm



1/2  
**26-173**  
Lichtenberg  
20cm



1/2  
**26-174**  
Langhals  
20cm 25cm



1/2  
**26-175**  
Lichtenberg  
20cm 25cm



1/2  
**26-176**  
Luehty-Beck  
20cm 25cm



1/2  
**26-177**  
Luehty-Beck  
20cm 25cm



1/2  
**26-178**  
Langebeck  
18cm  
20cm 23cm



1/2  
**26-179**  
Langebeck-beck  
18cm  
20cm 23cm



**Hospital Wares**

**27-101 - 115**  
 Schimmelbusch

	Ø x H sizes in mm
<b>27-101</b>	80 x 80
<b>27-102</b>	105 x 120
<b>27-103</b>	140 x 140
<b>27-104</b>	160 x 120
<b>27-105</b>	160 x 150
<b>27-106</b>	190 x 150
<b>27-107</b>	190 x 190
<b>27-108</b>	240 x 160
<b>27-109</b>	240 x 240
<b>27-110</b>	290 x 160
<b>27-111</b>	290 x 240
<b>27-112</b>	340 x 160
<b>27-113</b>	340 x 340
<b>27-114</b>	390 x 190
<b>27-115</b>	390 x 290



**27-116**  
 Box  
 120 x 65 x 13mm  
 (without Bulldog clamps,  
 without silicone tape)



**27-117**  
 Box with support  
 120 x 65 x 13 mm  
 (ohne Bulldogklemmen)



**27-118**  
 Box with support for  
 needle electrodes,  
 without instruments



**27-119 - 121**  
 50 x 25 x 4,5 mm  
**27-120**  
 65 x 42 x 8 mm  
**27-121**  
 75 x 25 x 4,5 mm

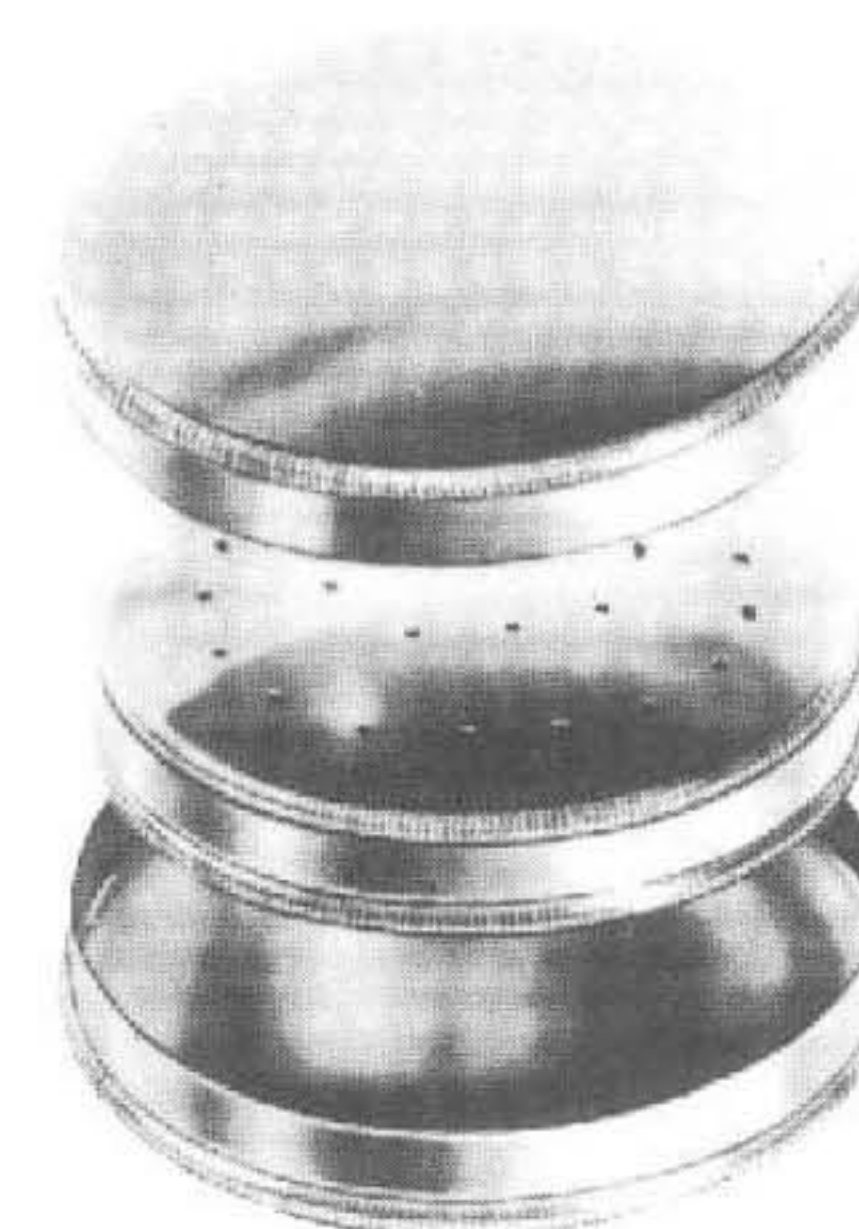

**27-122**  
 Ø 65mm x 15mm



**Hospital Wares**

**27-123 - 131**

	Ø x H
27-123	30 x 90 mm
27-124	50 x 100 mm
27-125	50 x 130 mm
27-126	50 x 175 mm
27-127	75 x 100 mm
27-128	75 x 130 mm
27-129	75 x 175 mm
27-130	100 x 175 mm
27-131	100 x 200 mm



**27-132 - 139**

27-132	165 x 85 x 35 mm
27-133	200 x 100 x 35 mm
27-134	200 x 100 x 50 mm
27-135	230 x 130 x 50 mm
27-136	260 x 150 x 50 mm
27-137	270 x 235 x 50 mm
27-138	300 x 200 x 50 mm
27-139	325 x 275 x 50 mm

**27-140**  
 205 x 105 x 35 mm

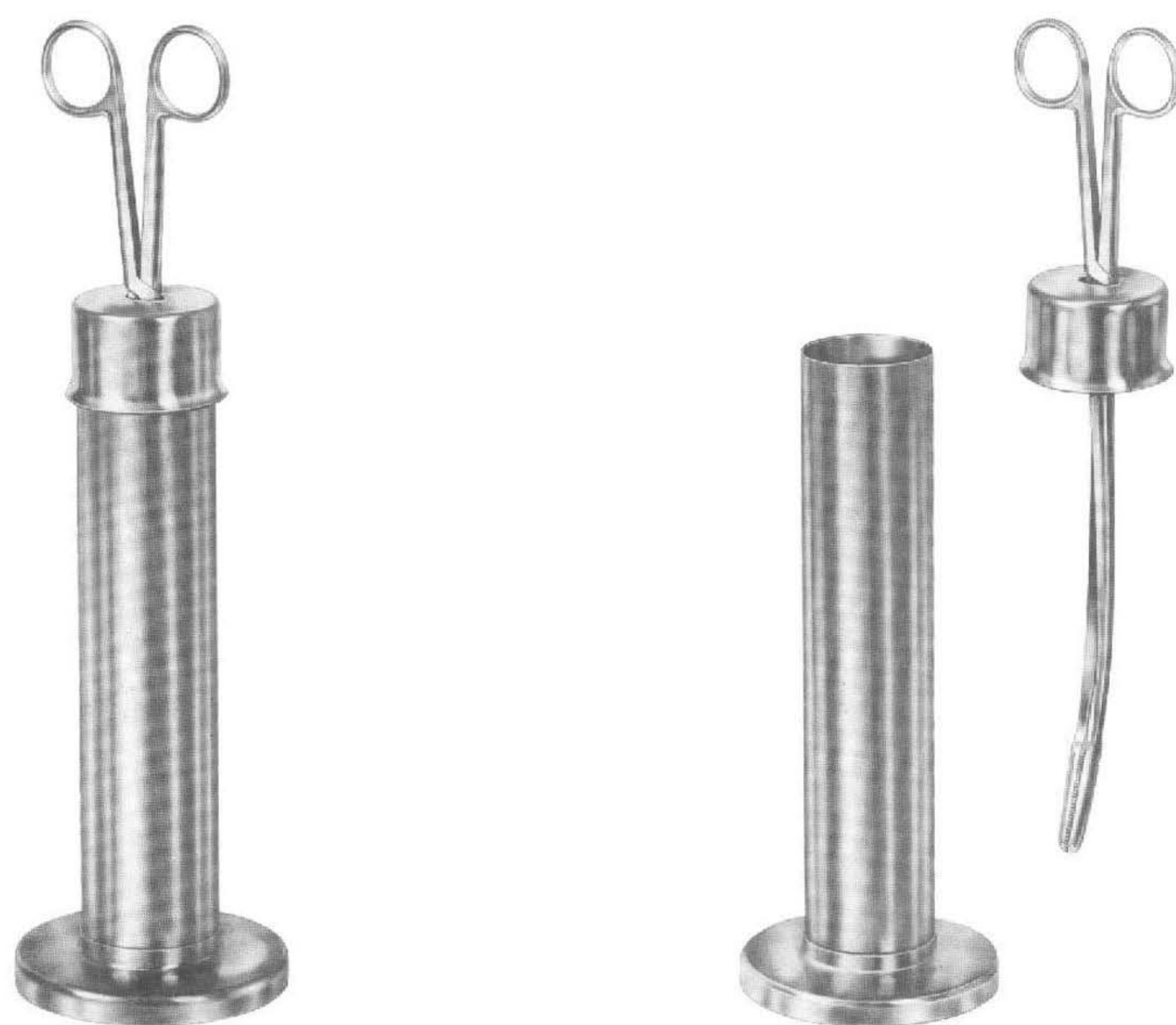

## Forceps Jars



**27-141 - 142**

- 27-141** | Martin Sterilizing Forceps  
consisting of:  
1 Sterilizing Forceps, curved, 25 cm,  
without ratchet, with lid for jar  
1 jar with bottom plate (anti-tilt)
- 27-142** | ditto, with 32 cm long Sterilizing Forceps



# Round Metal Boxes and Medicine Cups

**27-143 - 148**

	Ø x H
27-143	75 x 60 mm
27-144	75 x 75 mm
27-145	100 x 60 mm
27-146	100 x 100 mm
27-146A	125 x 80 mm
27-147	125 x 125 mm
27-148	150 x 150 mm

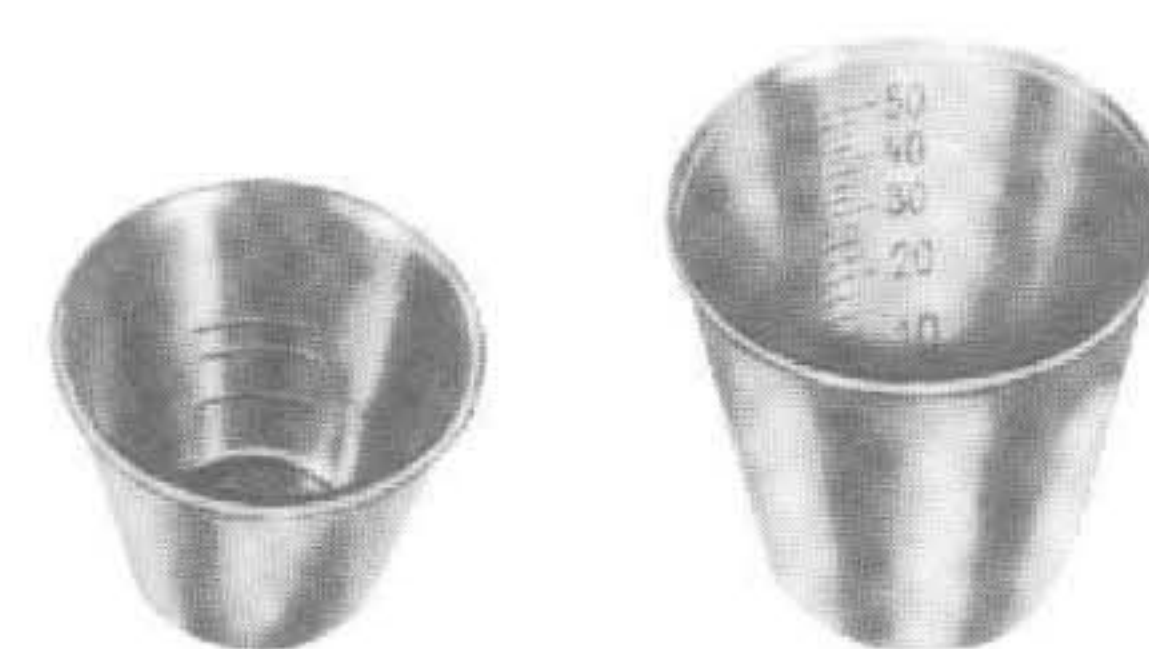

**27-149**  
 25 cc

**27-150**  
 50 cc

**27-151**  
 20 cc  
 Medicine Spoon

**27-152**  
 Ø75 x 12 mm  
 Tablet Tray

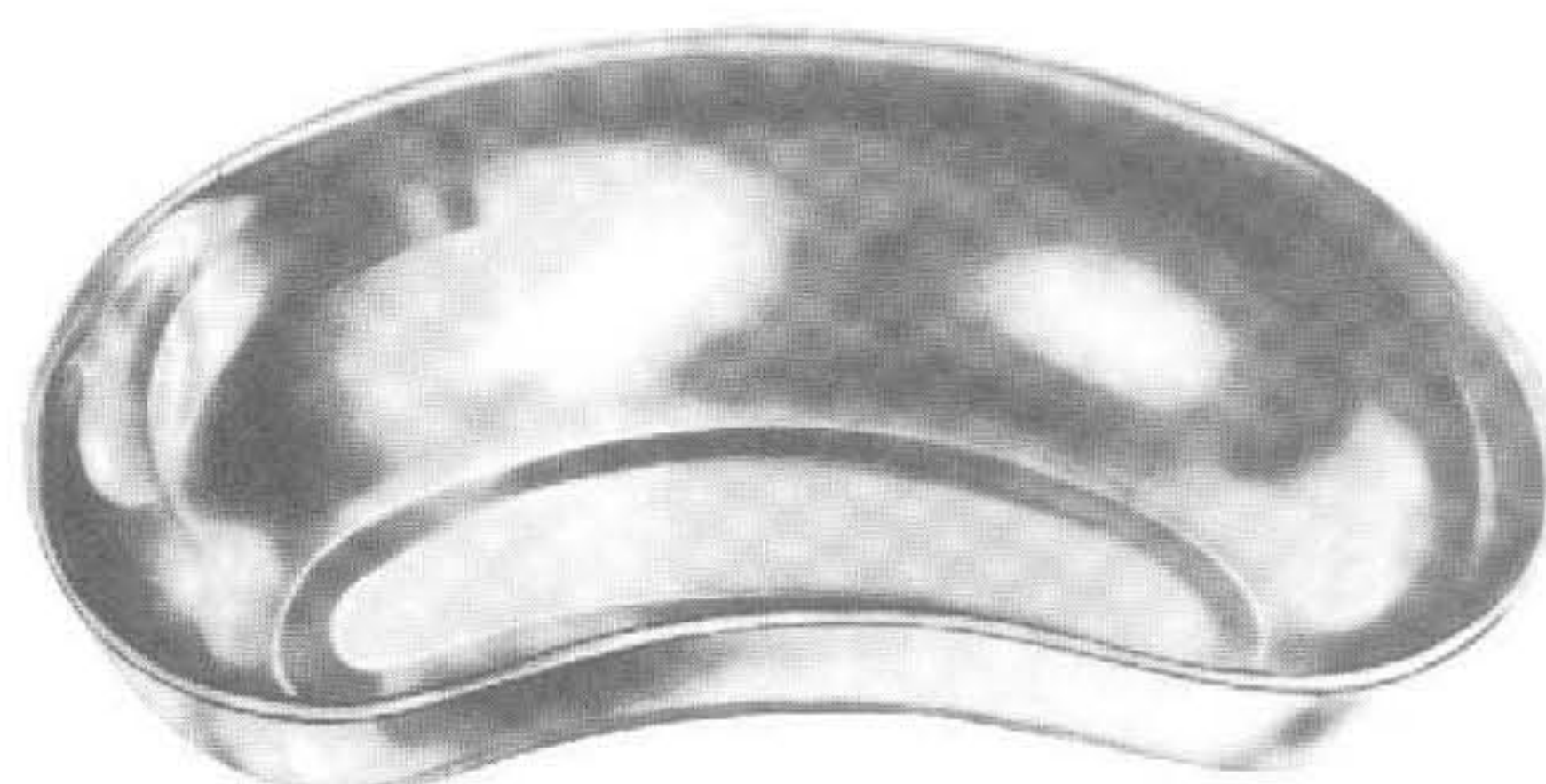
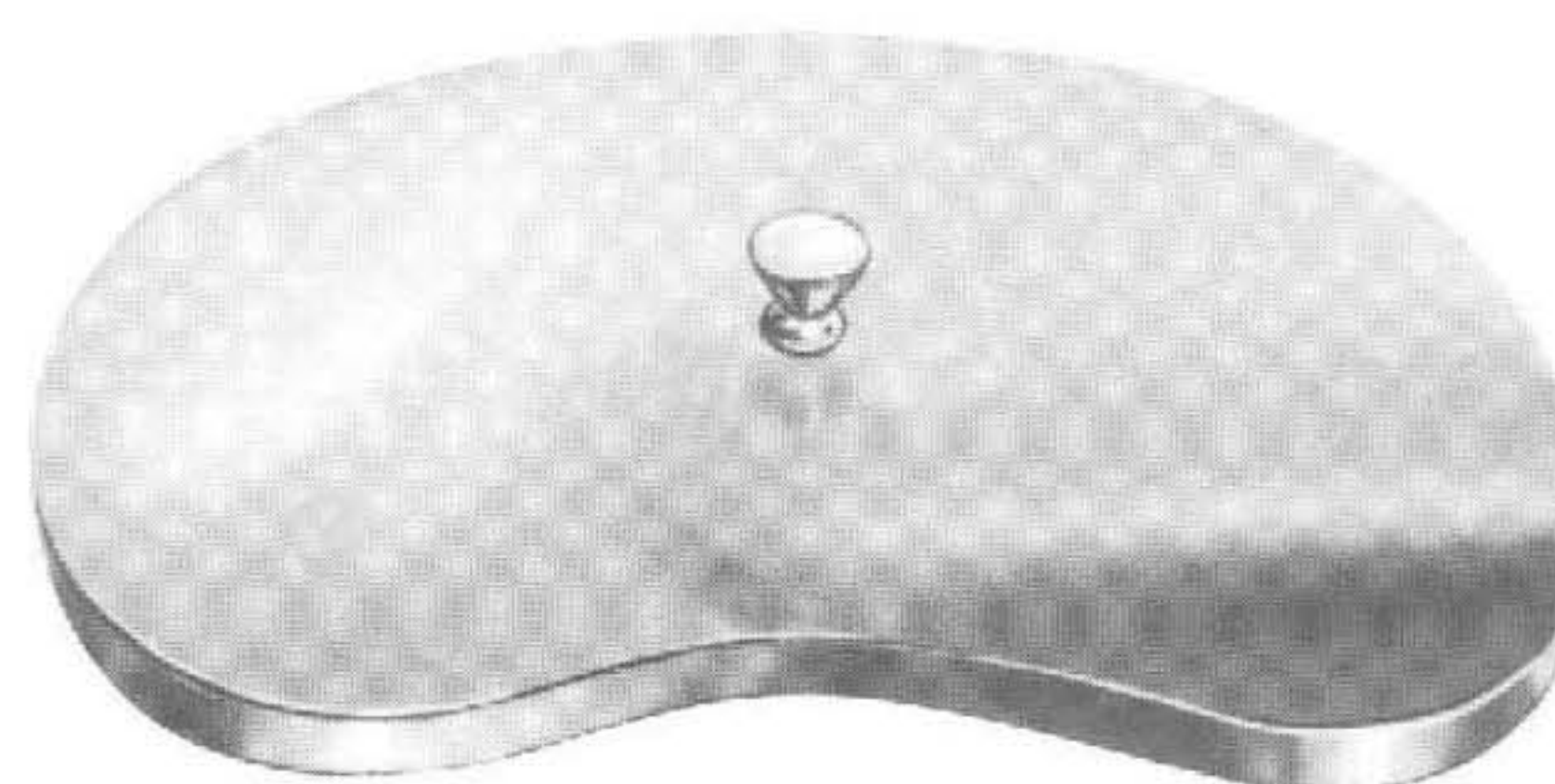
**27-153**  
 Ø90 x 90 mm  
 Metal Cup

**27-154**  
 Ø75 x 80 mm  
 Sputum Cup

**Kidney Dish**

**27-155 - 157**

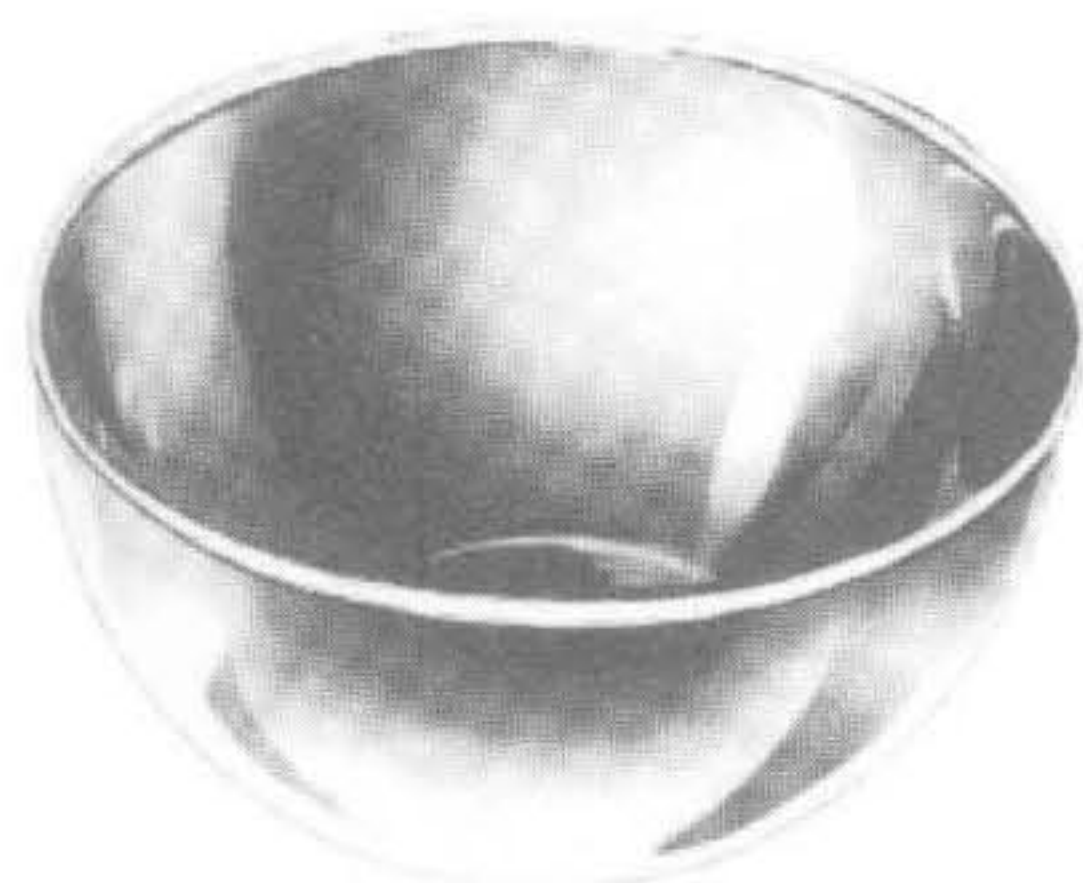
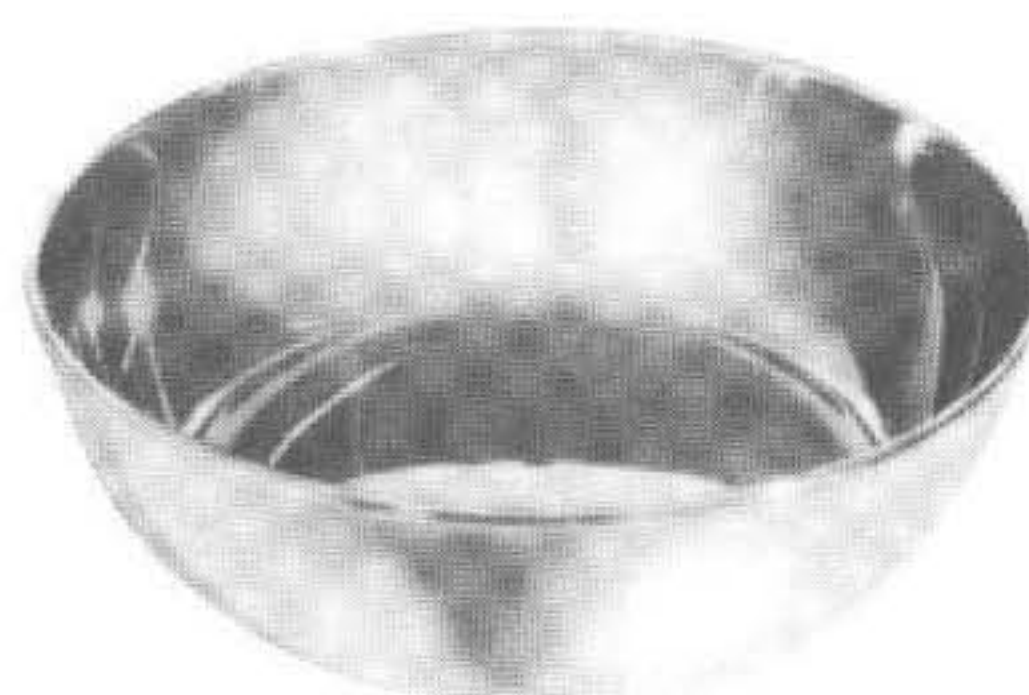
27-155	170 x 100 x 35 mm
27-156	250 x 140 x 40 mm
27-157	275 x 150 x 45 mm



**Hospital Wares**

**27-158 - 165**

**27-166 - 170**

	Ø x H		
<b>27-158</b>	40 x 19	mm	0.05L
<b>27-159</b>	61 x 30	mm	0.07L
<b>27-160</b>	80 x 40	mm	0.14L
<b>27-161</b>	116 x 50	mm	0.35L
<b>27-162</b>	128 x 55	mm	0.45L
<b>27-163</b>	147 x 65	mm	0.70L
<b>27-164</b>	167 x 75	mm	1.10L
<b>27-165</b>	187 x 85	mm	1.60L

<b>27-166</b>	116 x 35	mm	0.30L
<b>27-167</b>	128 x 38	mm	0.40L
<b>27-168</b>	147 x 40	mm	0.50L
<b>27-169</b>	157 x 45	mm	0.75L
<b>27-170</b>	187 x 45	mm	1.00L

**27-171**  
 Ø 110 x 28 mm 0.15L

**27-172**  
 100 cc 0.1L

**27-173 - 176**  
**27-173** 0,25L  
**27-174** 0,50L  
**27-175** 1,00L  
**27-176** 2,00L

**27-177**  
 235 x 190 x 40 mm

**27-178**  
 ø 220 x 70 mm



Hospital Wares

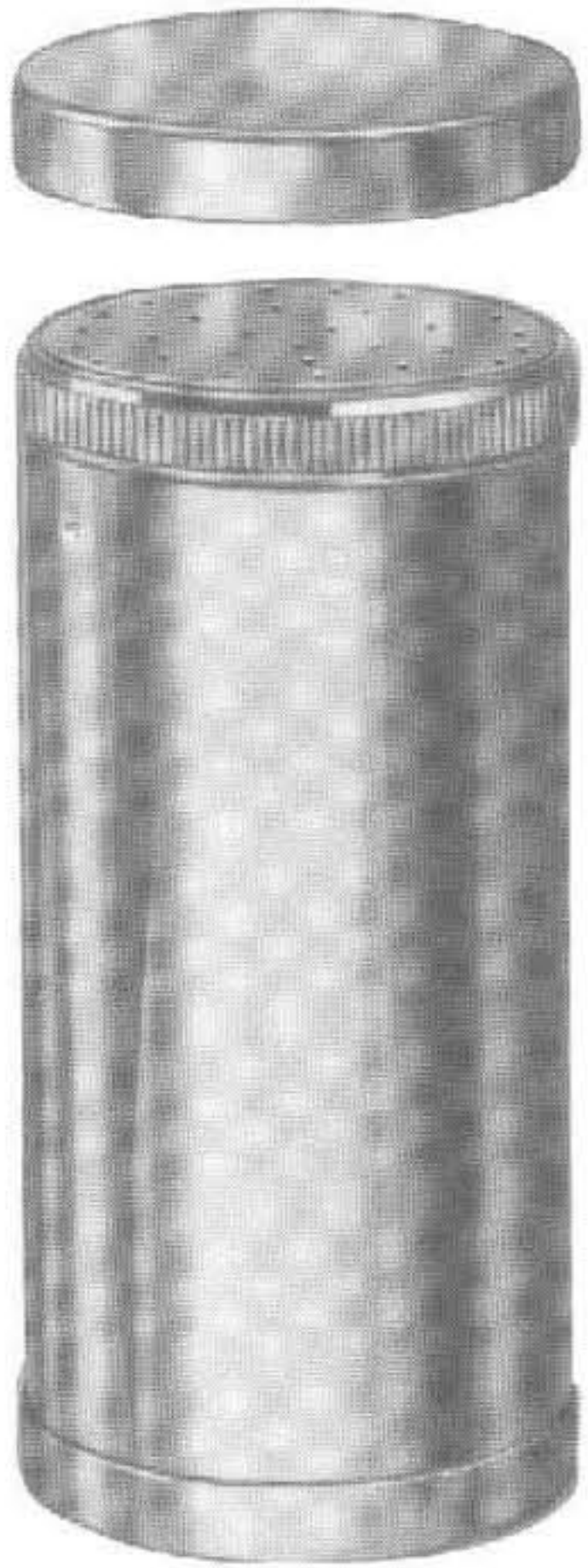

**27-179**  
∅ 50 x 100 mm  
Powder Pot



**27-180**  
∅ 50 x 75 mm  
Methot With Lid



**27-181**  
∅ 50 x 75 mm  
Methot Without Lid

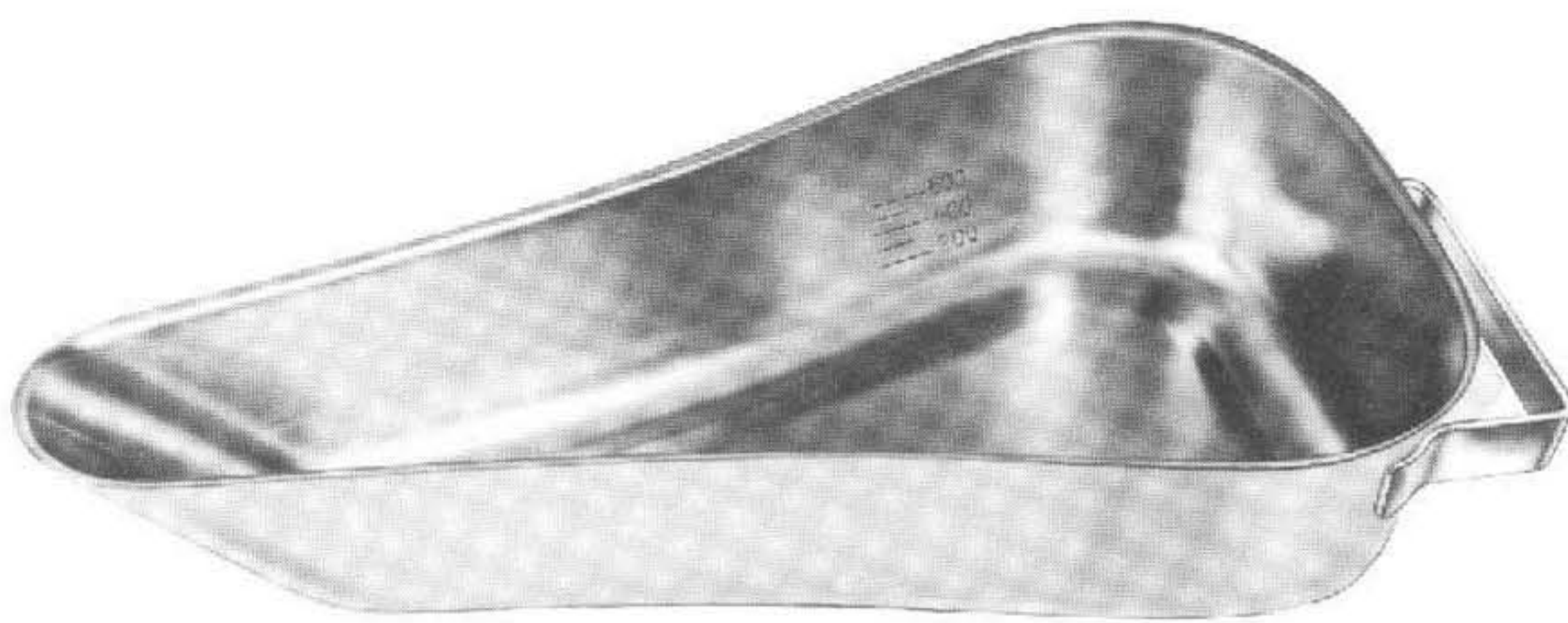

**27-182**

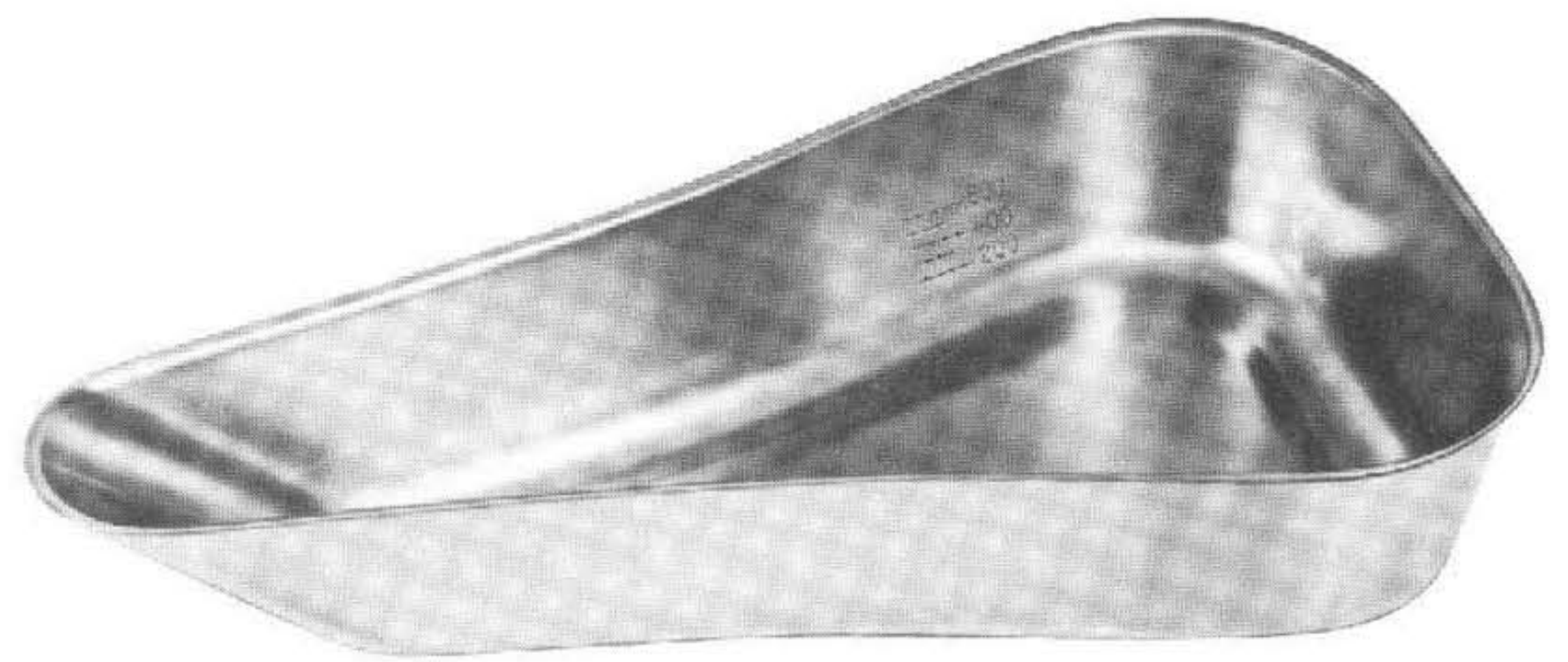

**27-183**



**27-184**

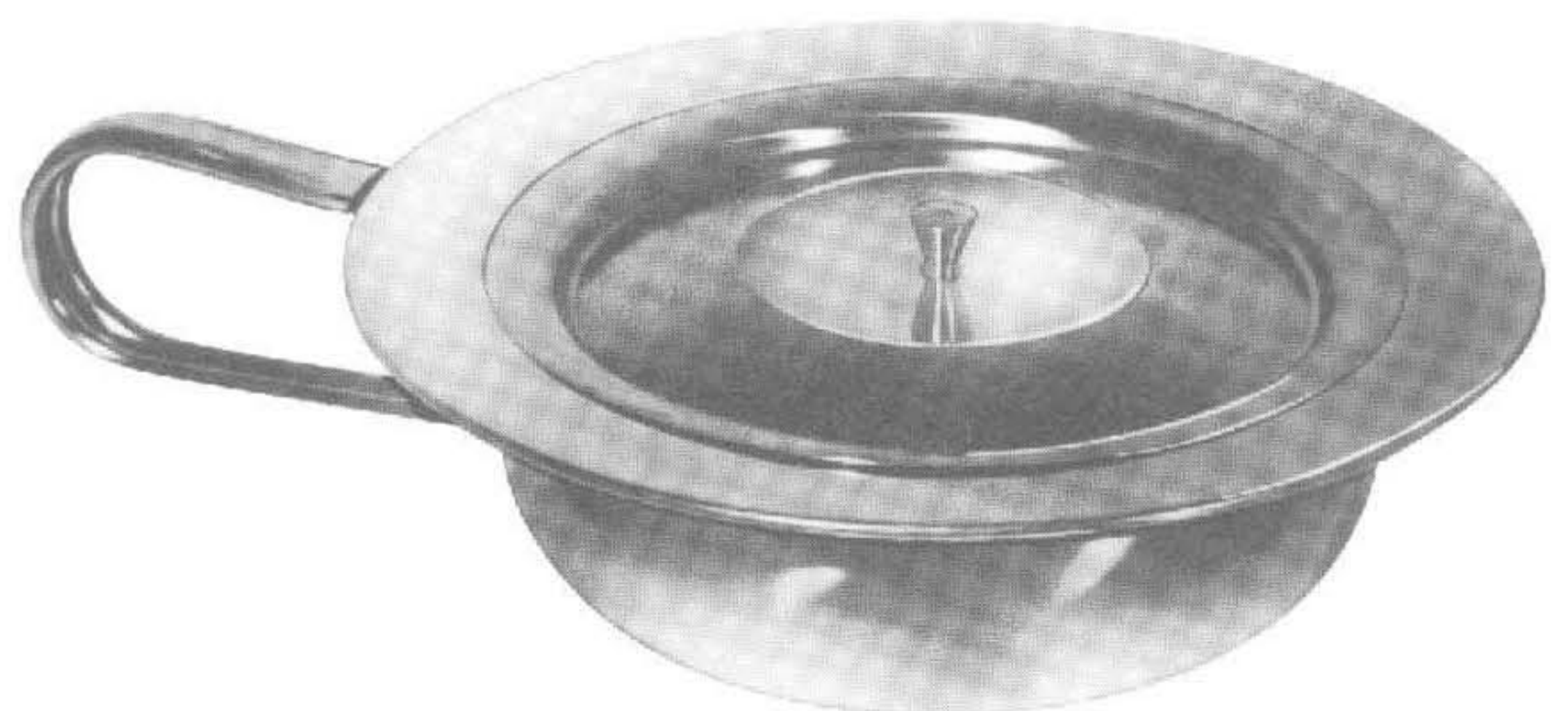

**27-185 - 186**

**27-185** ∅235 mm  
**27-186** ∅310 mm



# Needle Cases



**27-187**  
Sauerbruch  
210 x 125 x 17 mm



**27-188**  
Sauerbruch  
210 x 125 x 17 mm



**27-189**  
150 x 95 x 13 mm

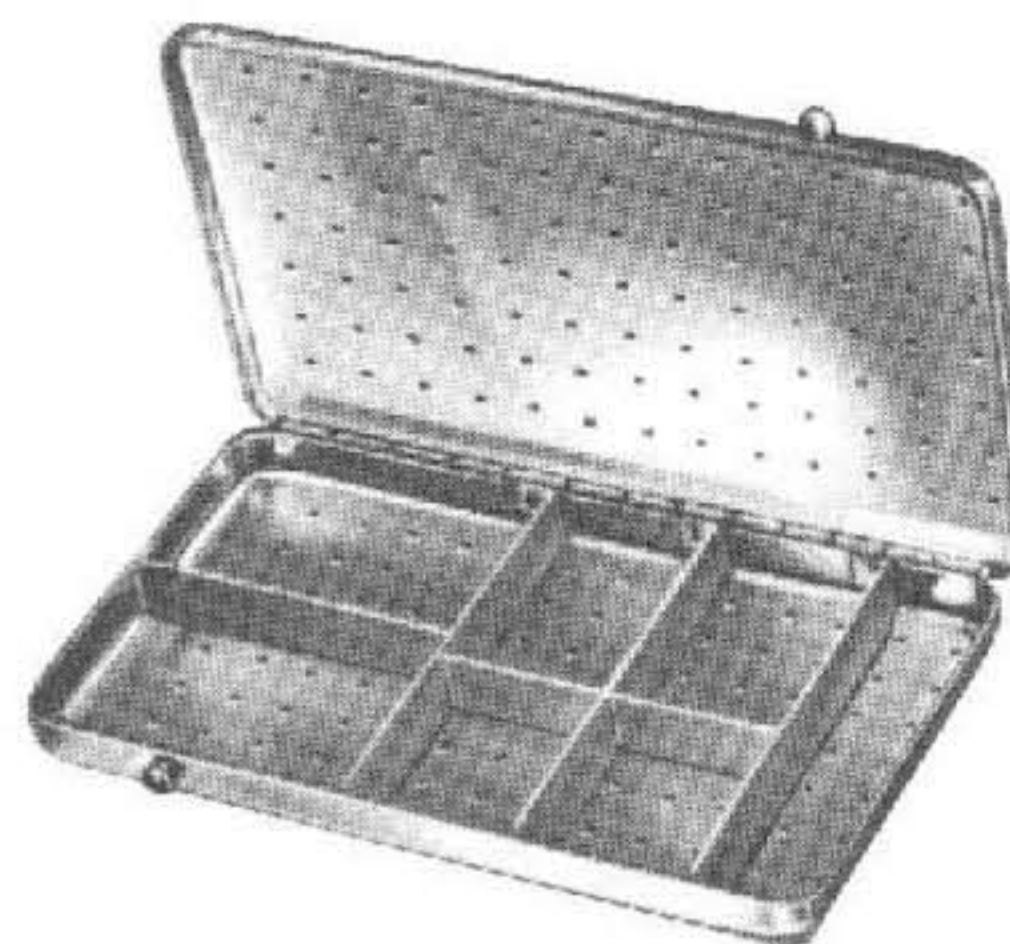

**27-190**  
150 x 95 x 13 mm



**27-191**  
150 x 95 x 13 mm



**27-192**  
150 x 95 x 13 mm



**27-193**  
150 x 95 x 13 mm



**27-194**  
150 x 95 x 13 mm

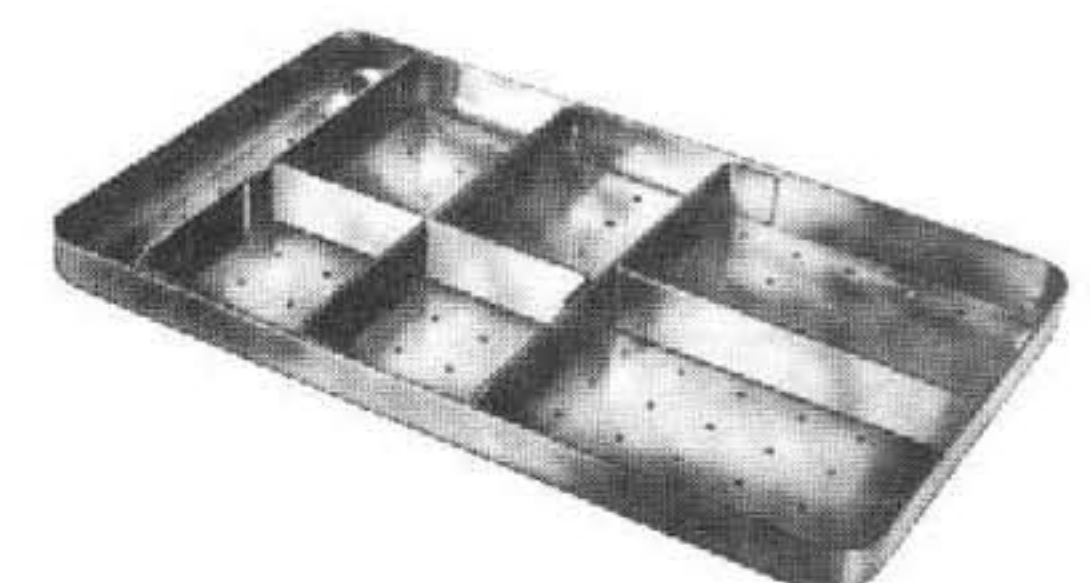

**27-195**  
150 x 95 x 11 mm



## Storing Cases



**27-196**  
Deponette  
245 x 135 x 35mm



**27-197**  
Deponette  
245 x 135 x 50mm



**27-198**  
Deponette  
245 x 135 x 60mm



# Storing Cases

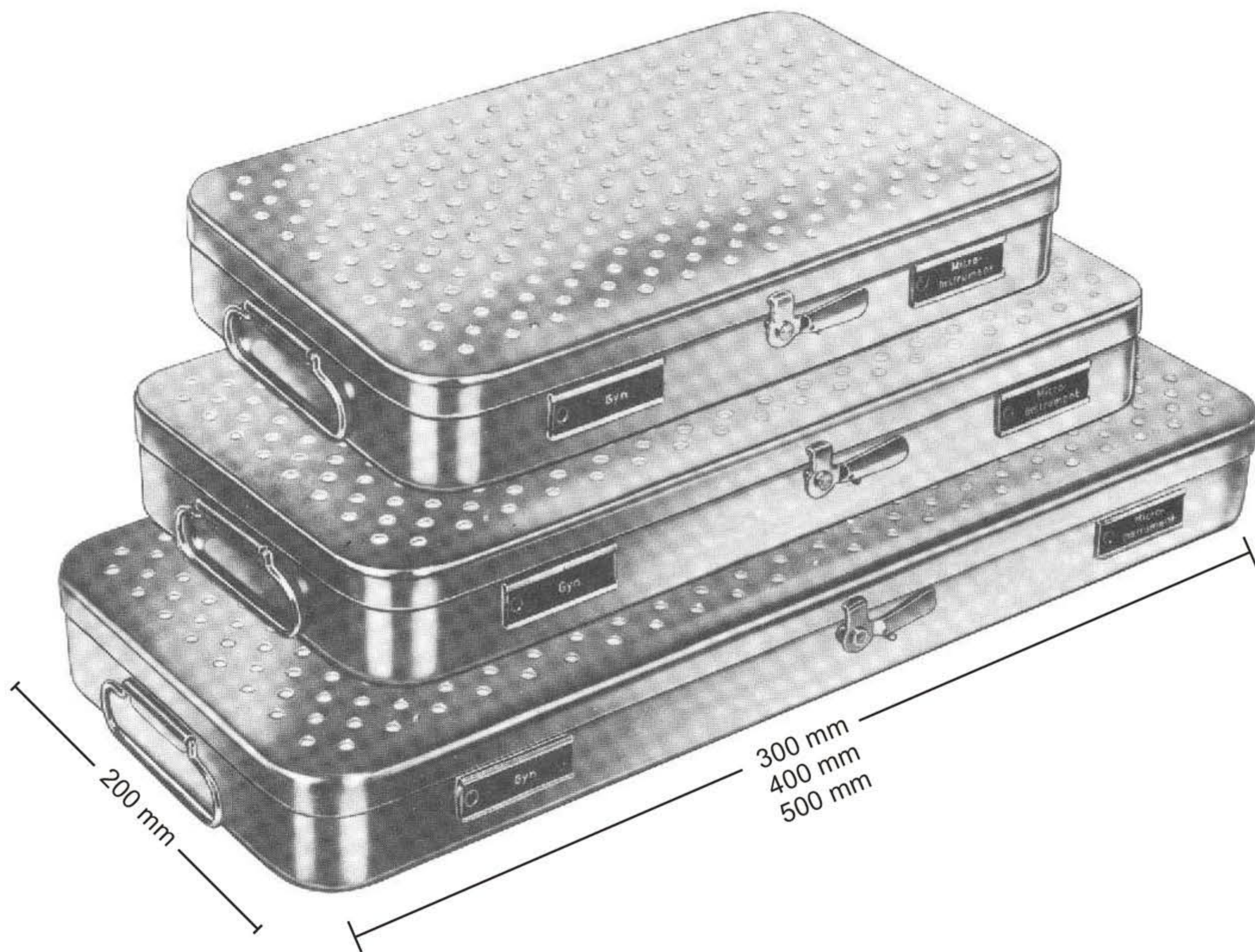

27-199 - 209

27-199	230 x 130 x 50	mm
27-200	260 x 150 x 50	mm
27-201	275 x 235 x 50	mm
27-202	300 x 200 x 50	mm
27-203	325 x 275 x 50	mm
27-204	420 x 175 x 50	mm
27-205	230 x 130 x 75	mm
27-206	260 x 150 x 75	mm
27-207	300 x 200 x 75	mm
27-208	325 x 275 x 75	mm
27-209	420 x 175 x 75	mm



## Sterilizing Baskets / Trays

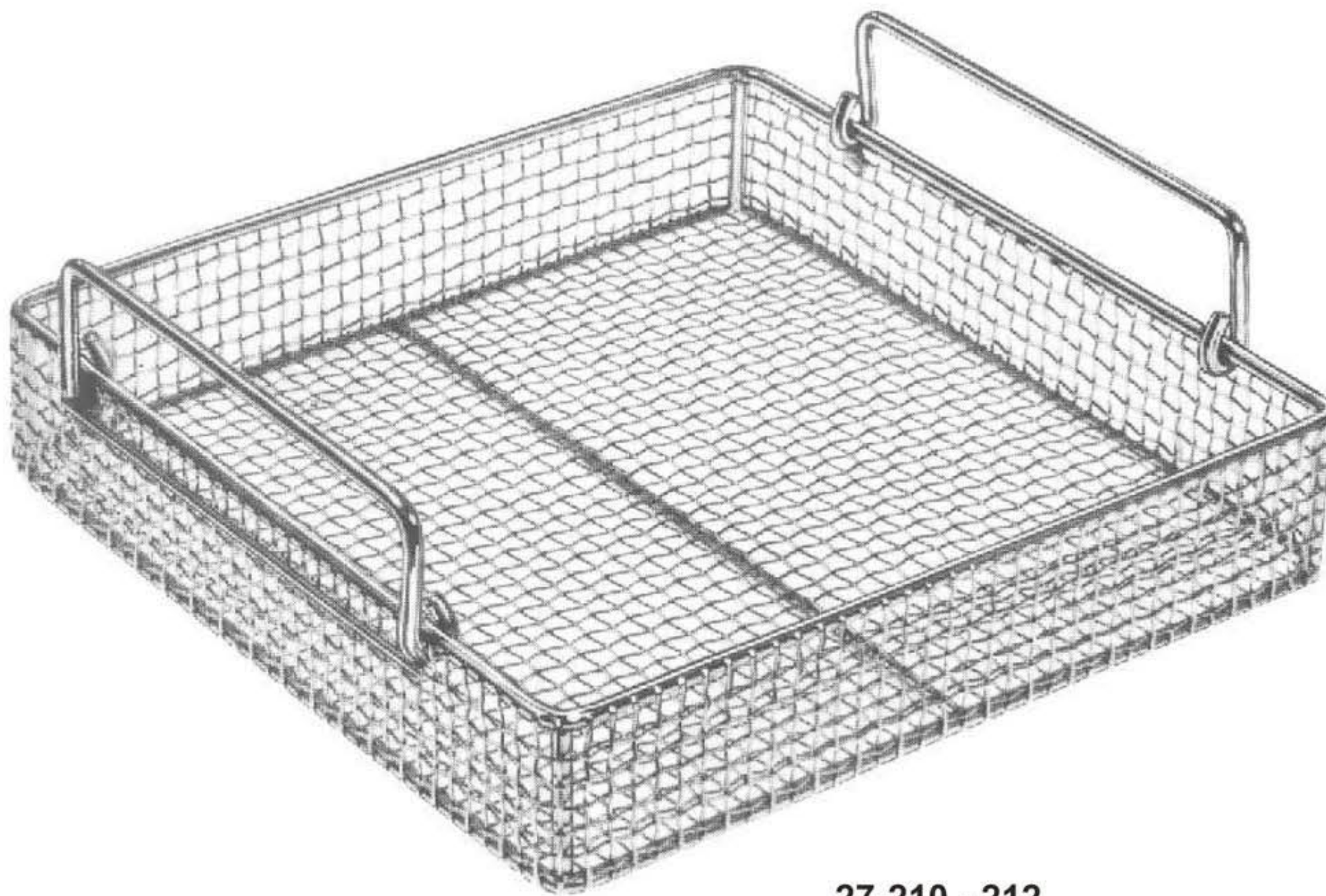

27-210 - 212

<b>27-210</b>	480 x 250 x 50	mm
<b>27-211</b>	520 x 250 x 75	mm
<b>27-212</b>	520 x 250 x 100	mm



27-213 - 218

<b>27-213</b>	240 x 240 x 50	mm
<b>27-214</b>	240 x 240 x 80	mm
<b>27-215</b>	240 x 240 x 100	mm
<b>27-216</b>	480 x 260 x 50	mm
<b>27-217</b>	520 x 260 x 80	mm
<b>27-218</b>	520 x 260 x 100	mm



## Sterilizing Basket

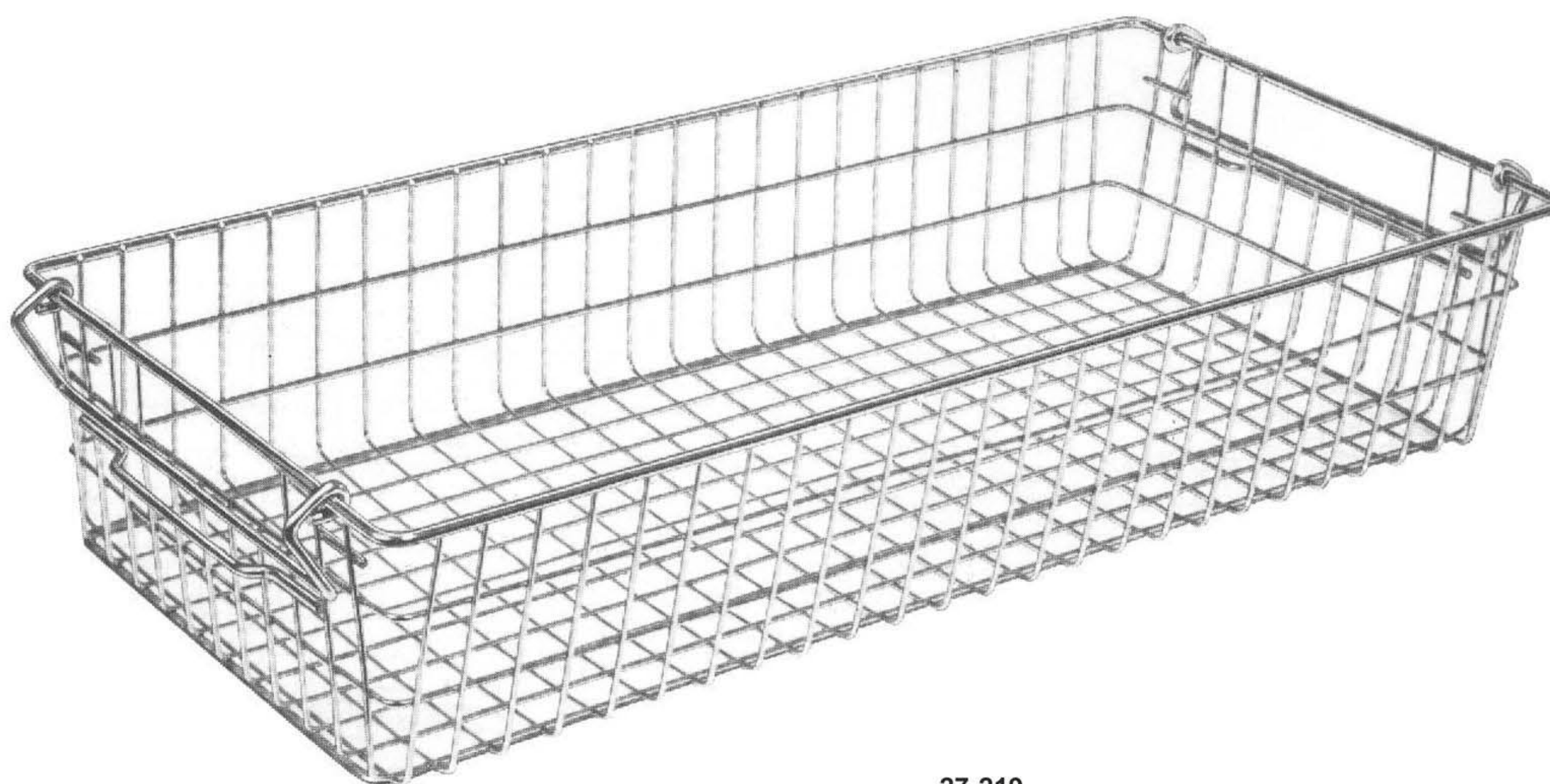

**27-219**  
(60 x 30 x 15 cm)  
Nominal dimensions





**ASSURE**  
*Surgical*

Manufacturers & Exporter of Surgical, Dental, & Beauty Instruments.

**ASSURE SURGICAL**

**FACTORY: MOHALA MASHRAQI MURADPUR,  
SIALKOT 51310, PAKISTAN.**

**PHONE: 0092 322 7550 226**

**E-MAIL: [INFO@ASSURESURGICAL.COM](mailto:INFO@ASSURESURGICAL.COM)**

**WEB: [WWW.ASSURESURGICAL.COM](http://WWW.ASSURESURGICAL.COM)**